

use & care guide

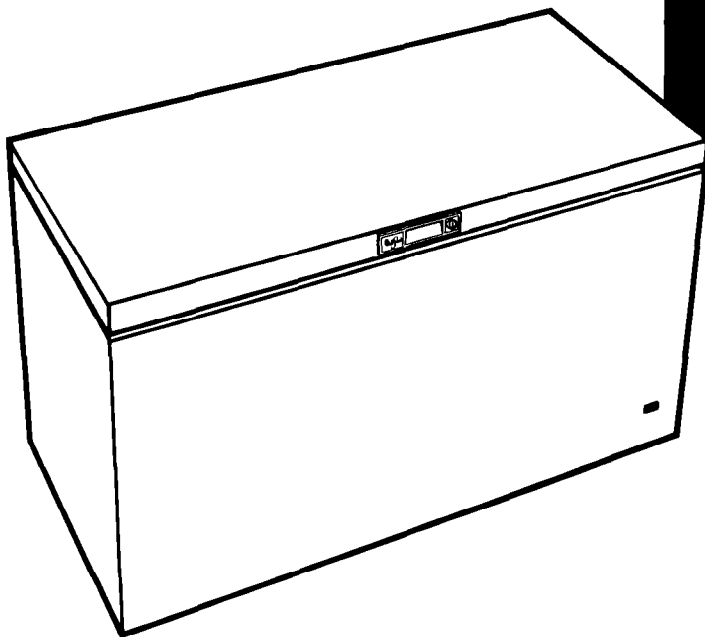



Whirlpool

CHEST FREEZER

Model EH1500

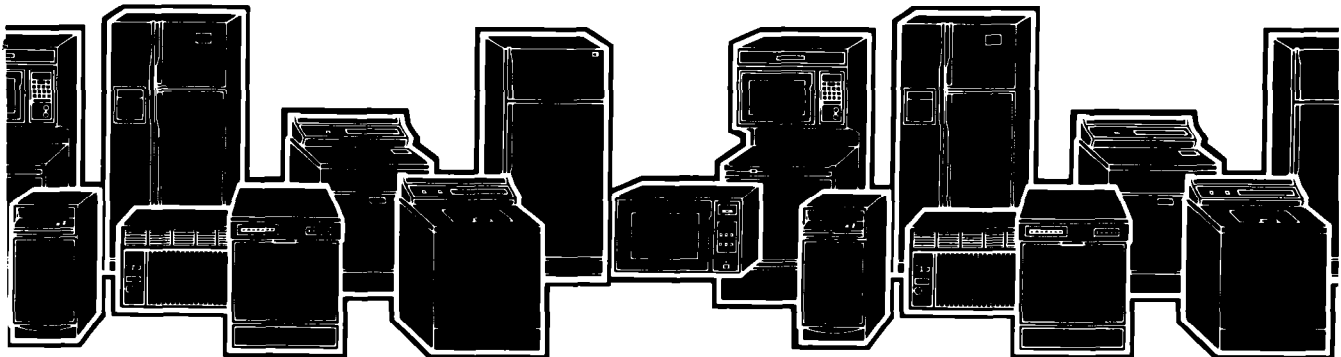
ers, Freezers, Refrigerator-Freezers, Ice Makers, Dishwashers, Built-In Ovens and Surface Units, Ranges, Microwave Ovens, Trash Compactors, Room Air Conditioners, Dehumidifiers



Please read this Use and Care Guide before you do anything else...

This booklet tells you how to start your freezer, defrost it, clean it, and adjust controls.

Treat your new freezer with care. Use it only to do what chest freezers are designed to do.

Parts and features

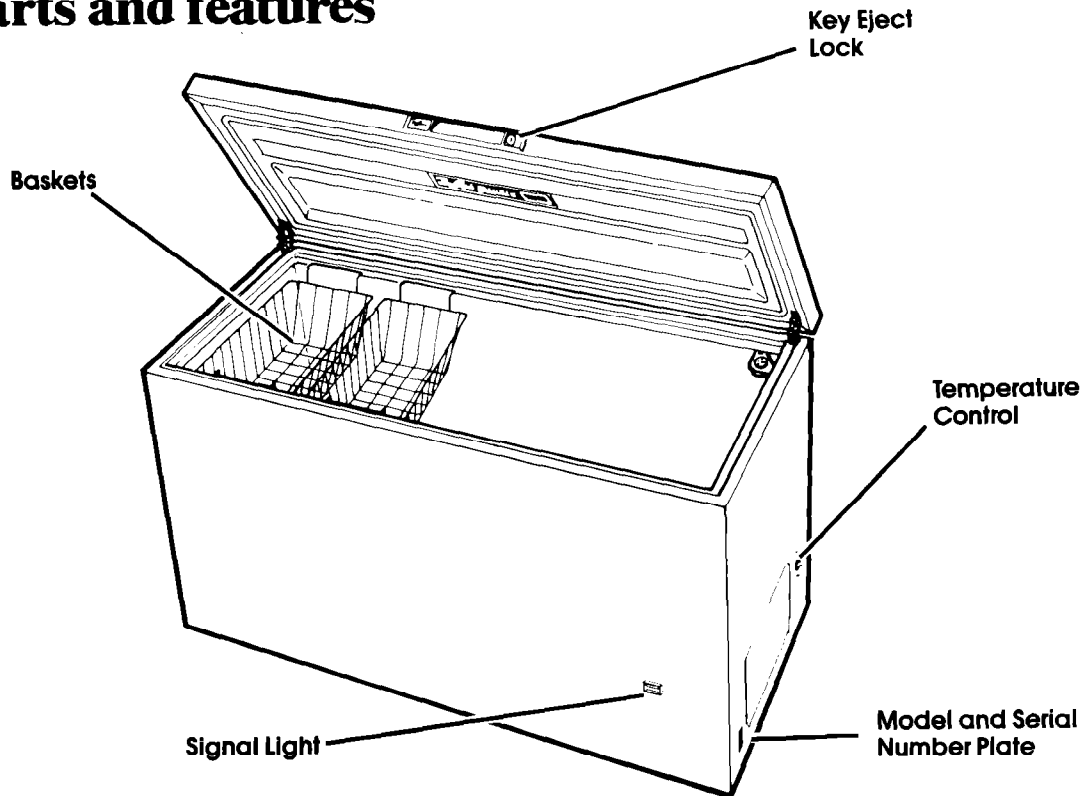

Copy your Model and Serial Numbers here...

When you need service, or call with a question, have this information ready:

1. **Complete** Model and Serial Numbers (from the plate located as shown.)
2. Purchase date from sales invoice.

Copy this information in these spaces. Keep this book, your warranty, and sales invoice together in a handy place. There is no warranty registration to return. Proof-of-purchase is all that is required for in-warranty service.

Model Number

Serial Number

Purchase Date

Service Company and Telephone Number

Contents

	Page		Page
SAFETY FIRST	3	The Signal Light	5
BEFORE YOU PLUG IT IN	3	Energy Saving Tips	5
Install Properly	4	CLEANING YOUR FREEZER	6
Level Chest Freezer	4	Cleaning Chart	6
Clean It	4	SHUTTING OFF AND MOVING	
Plug It In	4	YOUR FREEZER	6
USING YOUR FREEZER	5	IF YOU NEED SERVICE OR ASSISTANCE	7
Setting the Temperature Control	5	1. Before Calling For Assistance	7
Adjusting the Temperature Control	5	2. If You Need Assistance	7
Cooling Freezer First	5	3. If You Need Service	7
The Sliding Baskets	5	4. If You Have a Problem	7
The Key Eject Lock	5		

©1985 Whirlpool Corporation

Safety first

Child entrapment and suffocation are not things of the past. Junked or abandoned freezers are still dangerous... even if they will "just sit in the garage a few days."

If you are getting rid of your old freezer, do it safely. Please read the enclosed safety booklet from the Association of Home Appliance Manufacturers. Help prevent accidents.

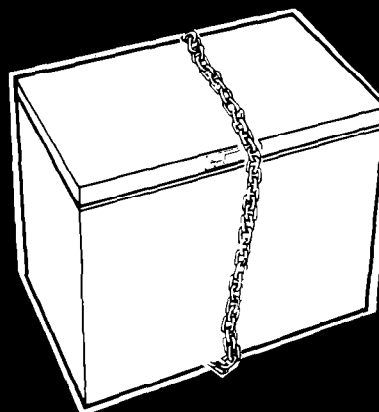

Before you plug it in

IMPORTANT

Before using your freezer, you are personally responsible for making sure that it...

- is installed and levelled on a floor that will hold the weight, and in an area suitable for its size and use.
- is connected only to the right kind of outlet, with the right electrical supply and grounding. (Refer to your "Electrical Requirements and Grounding Instructions.")
- is used only for jobs expected of chest freezers.
- is not near an oven, radiator or other heat source.
- is properly maintained.
- is out of the weather.
- is used in an area where the room temperature will not exceed 110°F (43.3°C).
- is not run where there are explosive fumes.
- is not used by those who may not understand how it should be used.
- is not loaded with food before it has time to get properly cold.

Install properly...

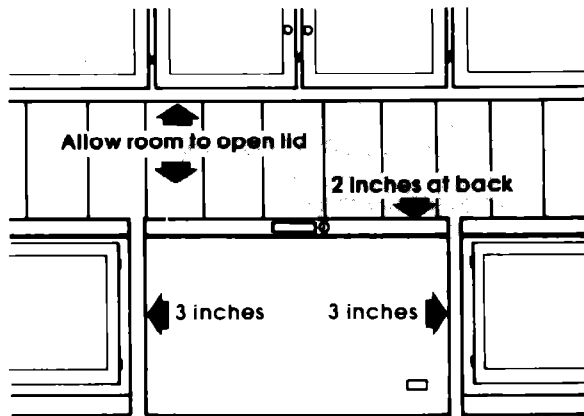

1. Check the strength of the floor. It should hold the weight of a fully loaded freezer.
2. **Pick a safe place, indoors, away from inflammables such as gasoline.**
3. Allow at least 3 inches (7.5 cm) air space on all sides of freezer and 2 inches (5 cm) at back. Leave room at top for lid to open all the way.
4. It should not be necessary to remove the lid during installation. If, for any reason, the hinges need adjustment, see your authorized service agency.
5. **Do not cover the freezer with items such as blankets, sheets, tablecloths, etc.**

If required by sanitation code, seal the cabinet to the floor with the approved floor seal kit. This kit (Part No. 702509) can be purchased from your Whirlpool Appliance Dealer or from Whirlpool Corporation, LaPorte Division, 1900 Whirlpool Drive, LaPorte, Indiana 46350.

Level chest freezer...

from end to end and front to back so that the lid will seal properly.

Check with level

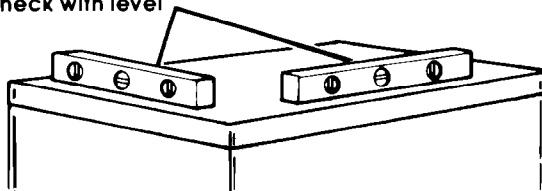

Clean it...

Clean your freezer before using it. See cleaning instructions on page 6.



Plug it in...

3-prong grounding type wall receptacle

Retaining Clip

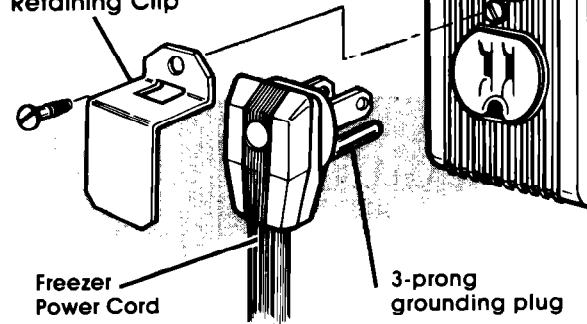

Recommended Grounding Method

A 115 Volt, 60 Hz., AC only 15 or 20 ampere fused and properly grounded electrical supply is required. It is recommended that a separate circuit serving only this appliance be provided. **Use a receptacle which cannot be turned off with a switch or pull chain. Do not use an extension cord.**

Attach retaining clip over power cord plug from literature package inside the freezer.

Using your freezer

Setting the temperature control...

1. Insert a coin in the slot of the Temperature Control to turn it.
2. Turn control to Number 3. This setting is designed to maintain the temperature at or near 0°F (-17.8°C) under normal operating conditions.



Adjusting the temperature control...

1. Turn control to higher number for colder temperatures.
2. Turn to lower number for less cold temperatures.

Cooling freezer first...

Allow freezer to cool 6 to 8 hours before filling with **frozen food**.

NOTE: When freezer is first started the compressor will run constantly until the cabinet is cooled. It may take up to 6 to 8 hours or longer, depending on room temperature and the number of times the freezer lid is opened.

After the cabinet is cooled the compressor will turn on and off as needed to keep freezer at proper temperature.

The sliding baskets...

can be moved from side to side or removed when loading or unloading food below it.

To remove:

Lift baskets out.

To replace:

Lower baskets into place.

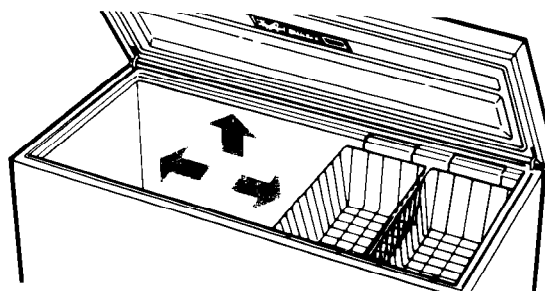

The key eject lock...

can help reduce the hazard of child entrapment.

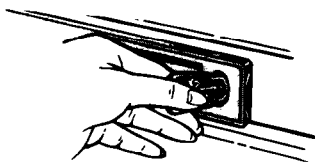

To lock or unlock the freezer you must hold the key in the lock while turning. The lock is spring loaded so the key cannot be left in the lock.

If the key is lost, contact your service agency for a replacement. Always give the **complete** model and serial number of your freezer when requesting a replacement key.

The signal light...

automatically warns of any unexpected power failure.

If the signal light is not glowing, immediately check:

- for power interruption,
- for an unplugged power cord,
- for a burned out signal light.



To replace:

1. Unplug power cord from outlet.
2. Carefully snap out light cover and assembly with a screwdriver by inserting it under the end of metal edge of the light. Be careful not to chip finish on freezer.
3. Unplug burned out signal light and replace with a new one. Signal light can be ordered from your service agency.
4. Then, snap light assembly into place.
5. Plug power cord into outlet.

Energy Saving Tips...

- Check lid gasket and level cabinet to ensure a good lid seal. Keeping freezer locked ensures lid closure.
- Keep lid openings to a minimum. Remove several items at one time. Keep contents organized to eliminate searching.

- Fill to capacity. Follow recommended procedures for freezing foods.
- Set Temperature Control to provide temperatures around 0°F (-17.8°C). There is no need to store foods below 0°F.
- **Do not let frost build up to more than ¼ inch (6 mm) thick.**

Cleaning your freezer

This freezer should be cleaned when frost has built up to about ¼ inch (6 mm) thickness. Complete defrosting and cleaning should be done at least once a year. In high humidity areas, a freezer may need more frequent defrosting.

To defrost and clean:

1. Turn Temperature Control to OFF.
2. Unplug freezer.
3. Take out all frozen food and sliding baskets.

NOTE: Wrap frozen packages in several layers of newspaper and cover with a blanket. Food will stay frozen several hours.

4. Clean freezer according to the following directions.



After defrosting:

1. Plug in freezer.
2. See directions for "Setting the Temperature Control," page 5.

Cleaning chart...

Part	What to use	How to clean
Removable parts (baskets)	Sponge or cloth; mild detergent and warm water.	<ul style="list-style-type: none">• Wash with warm water and a mild detergent.• Rinse and dry.
Outside	Sponge, cloth or paper towel; mild detergent; appliance wax (or good auto paste wax).	<ul style="list-style-type: none">• Wash with warm water and a mild detergent.• Do not use abrasive or harsh cleansers.• Rinse and dry.• Wax painted metal surfaces at least twice a year with appliance wax or a good auto paste wax. Apply wax with a clean, soft cloth.• Do not use wax on plastic parts.
Waxing painted metal surfaces provides rust protection.		
Inside walls	Plastic scraper, pans of hot water, electric fan, sponge or towel, baking soda and warm water.	<ul style="list-style-type: none">• Use plastic scraper to remove frost.• Place pans of hot water in freezer with lid open to speed melting. Directing air from an electric fan into freezer will also help.• Remove defrost water with towel or sponge.• Wash with solution of 2 tablespoons (26 g) baking soda to 1 quart (.95 L) warm water.• Rinse and dry.
DO NOT USE an ice pick, knife or other sharp-pointed tool or any type of electric defroster to defrost freezer. They can cause damage to the liner and interior parts.		
Lid gasket	Sponge, soft cloth or paper towel; mild detergent and warm water.	<ul style="list-style-type: none">• Wash with mild detergent and warm water.• Rinse and dry.
DO NOT USE cleaning waxes, concentrated detergents, bleaches or cleansers containing petroleum on plastic parts.		

Shutting off and moving your freezer

If freezer is shut off for more than 24 hours:

1. Remove and store all food.
2. Unplug freezer.
3. Clean thoroughly. See "Cleaning your freezer," page 6.
4. Block lid open for air circulation. Turn lock to locked position with lid open. Place blocks between lid and cabinet and tape in place with self-adhesive filament tape.

If you move the freezer:

1. Remove the sliding baskets.
2. **Do not place objects inside or on top of cabinet.**
3. Level properly to ensure good lid seal.

WARNING: Do not allow children near the freezer when the lid is blocked open. They may become injured or trapped.

If you need service or assistance, we suggest you follow these four steps:

1. Before calling for assistance...

Performance problems often result from little things you can find and fix yourself without tools of any kind.

If electricity goes off:

Learn how long power will be off by calling the power company.

- If service is to be interrupted 24 hours or less, keep freezer closed. Most food will stay frozen.
- If service is to be interrupted longer than 24 hours, do this:
 1. Remove all unfrozen food and store in a frozen food locker. **OR...**
 2. Place 2 lbs. (0.9 kg) of dry ice in freezer for every cu. ft. of freezer space. This will keep frozen foods for 2 to 4 days. Wear gloves to protect your hands from dry ice burns.
 3. If neither food locker storage or dry ice is available, use or can perishable food at once.
- The length of time food will stay frozen depends on several factors. For instance: a full freezer will remain cold longer than a freezer partially filled. And a freezer full of meat will stay cold longer than a freezer filled with baked goods. Also, if the food still contains ice crystals, it may be safely refrozen, although the quality and flavor may be affected. Use this food as soon as convenient. If the condition of the food is poor or is in any way questionable, it is wise to dispose of it.

If freezer stops running:

- Check to see if power cord is plugged into the outlet.
- Check fuse box or circuit breaker.
- Check electric company for a power failure.
- Be sure Temperature Control is turned ON.

If motor seems to run too long

On hot summer days or if room is hot, motor will run longer to provide correct amount of cooling.

If freezer feels warm

During normal operating conditions the freezer transfers heat removed from food packages and air space to the outside room air. The freezer cabinet may feel warm.

If frost builds up on the trim strip around top of cabinet

1. Check the fit of the lid to make sure it is sealing. With the lid closed, press down firmly on the edges or at the center of the lid. This pressure will cause the flexible lid to fit flat against the cabinet and seal.
2. Do not open or close the lid by grasping a corner. Use the handle.

2. If you need assistance*...

Call Whirlpool COOL-LINE® service assistance telephone number. Dial free from:

Continental U.S. (800) 253-1301
 Michigan (800) 632-2243
 Alaska & Hawaii (800) 253-1121

and talk with one of our trained Consultants. The Consultant can instruct you in how to obtain satisfactory operation from your appliance or, if service is necessary, recommend a qualified service company in your area.

3. If you need service*...

Whirlpool has a nationwide network of franchised TECH-CARE® Service Companies. TECH-CARE service technicians are trained to fulfill the product warranty and provide after-warranty service, anywhere in the United States. To locate



TECH-CARE service in your area, call our COOL-LINE service assistance telephone number (see Step 2) or look in your telephone directory Yellow Pages under:

APPLIANCES - HOUSEHOLD-
MAJOR - SERVICE & REPAIR

ELECTRICAL APPLIANCES-
MAJOR - REPAIRING & PARTS

OR

WHIRLPOOL APPLIANCES
FRANCHISED TECH-CARE SERVICE

WHIRLPOOL APPLIANCES
FRANCHISED TECH-CARE SERVICE

SERVICE COMPANIES
XYZ SERVICE CO
123 Maple ...

SERVICE COMPANIES
XYZ SERVICE CO
123 Maple ... 999-9999

OR

WASHING MACHINES, DRYERS
& IRONERS - SERVICING

WHIRLPOOL APPLIANCES
FRANCHISED TECH-CARE SERVICE

SERVICE COMPANIES
XYZ SERVICE CO
123 Maple ... 999-9999

4. If you have a problem*...

Call our COOL-LINE service assistance telephone number (see Step 2) and talk with one of our Consultants, or if you prefer, write to:

Mr. Stephen E. Upton
 Senior Vice President
 Whirlpool Corporation
 Administrative Center
 2000 US-33 North
 Benton Harbor, MI 49022

*If you must call or write, please provide: model number, serial number, date of purchase, and a complete description of the problem. This information is needed in order to better respond to your request for assistance.



Making your world a little easier.

Part No. 730202
©1985 Whirlpool Corporation

Printed in U.S.A.

ce Makers, Dishwashers, Built-In Ovens and Surface Units, Ranges, Microwave Ovens, Trash Compactors, Room Air Conditioners, Dehumidifiers, Automatic Washers, Clothes Dr

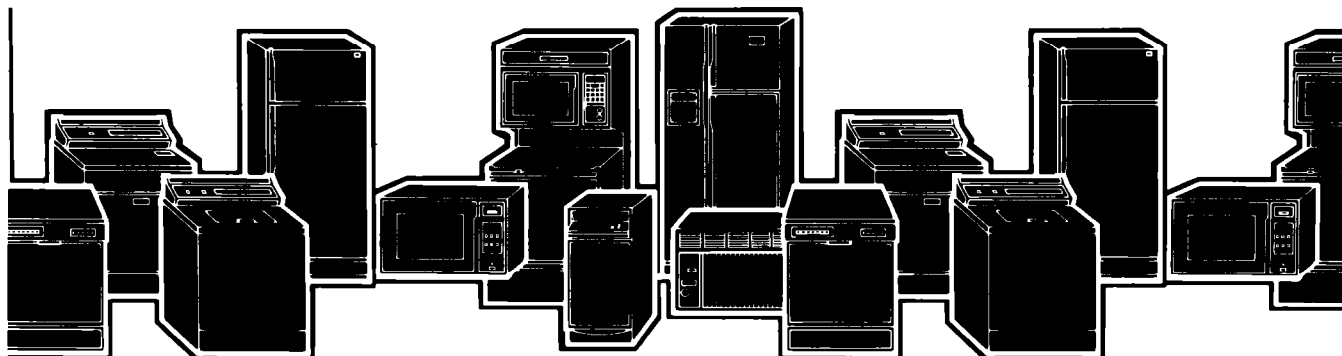

Free Manuals Download Website

<http://myh66.com>

<http://usermanuals.us>

<http://www.somanuals.com>

<http://www.4manuals.cc>

<http://www.manual-lib.com>

<http://www.404manual.com>

<http://www.luxmanual.com>

<http://aubethermostatmanual.com>

Golf course search by state

<http://golfingnear.com>

Email search by domain

<http://emailbydomain.com>

Auto manuals search

<http://auto.somanuals.com>

TV manuals search

<http://tv.somanuals.com>