



**NO-FROST UPRIGHT FREEZER**  
**Model EV150NXX**

# Use and Care Guide

## Safety First

Child entrapment, and suffocation are not things of the past. Junked or abandoned freezers are still dangerous...even if they will "just sit in the garage a few days."

If you are getting rid of your old freezer, do it safely. Please read the enclosed safety booklet from the Association of Home Appliance Manufacturers. Help prevent accidents.

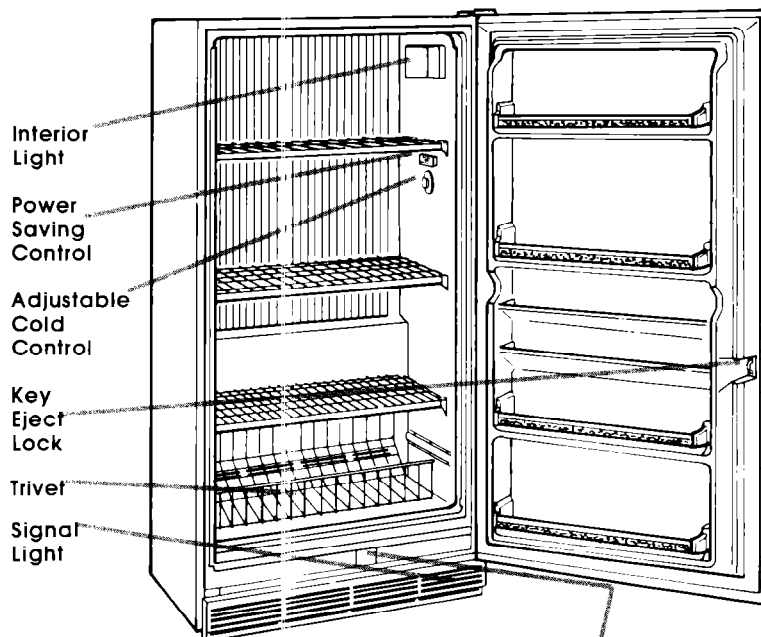

## Copy Your Model Number and Serial Number Here

When you need service, or call with a question, have this information ready:

1. **Complete** Model and Serial Numbers (from the plate just above base grille).
2. Purchase date from sales slip.

Copy this information in these spaces. Keep this book, your warranty and sales slip together in a handy place.

Model Number \_\_\_\_\_

Serial Number \_\_\_\_\_

Purchase Date \_\_\_\_\_

Service Company and Telephone Number \_\_\_\_\_

## Before you plug it in

Before using your freezer, you are personally responsible for making sure that it...

- is installed and leveled on a floor that will hold the weight, and in an area suitable for its size and use.
- is connected only to the right kind of outlet, with the right electrical supply and grounding.
- is used only for jobs expected of home freezers.
- is not near an oven, radiator or other heat source.

- is properly maintained.
- is in a dry sheltered place.
- is used in an area where the room temperature will not exceed 110°F (43.3°C).
- is not run where there are explosive fumes.
- is not used by children or others who may not understand how it should be used.
- is not loaded with food before it has time to get properly cold.

### Install Properly...

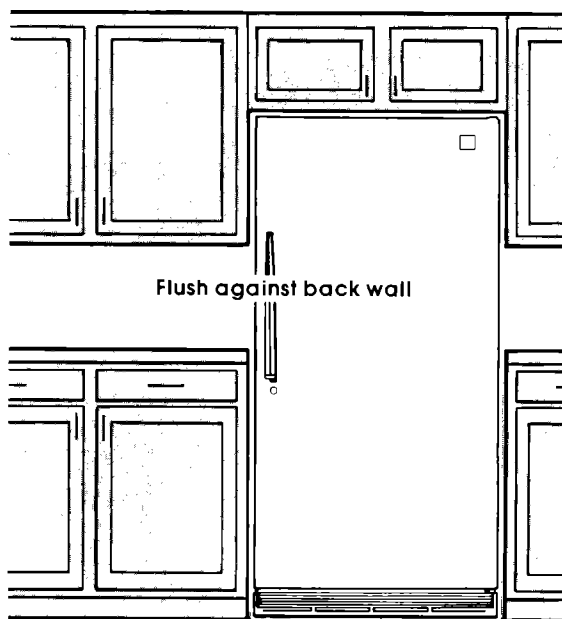

1. Check the strength of the floor. It should hold the weight of fully loaded freezer.
2. **Pick a safe place, indoors, away from inflammables such as gasoline.**
3. Freezer may be installed flush against wall in back. Allow ½ inch (1.25 cm) on each side of cabinet.

### Level Freezer...

so that door will stay open at any position.

1. Remove base grille (see page 4).
2. Starting with door hinge side, turn left to raise corner.
3. Turn right to lower corner.
4. Check with level.
5. After freezer is loaded with food, recheck with level.

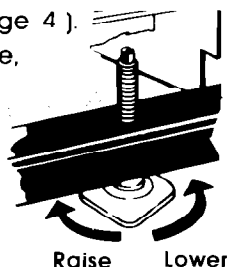

### Remove Sales Labels...

Remove the Consumer Buy Guide label and any inside labels before using the freezer. Remove any left over glue with rubbing alcohol.

**Note:** DO NOT REMOVE the Tech Sheet fastened behind the base grille.

### Clean It...

Clean your freezer before using it. See cleaning instructions on page 5.

### Plug it in...

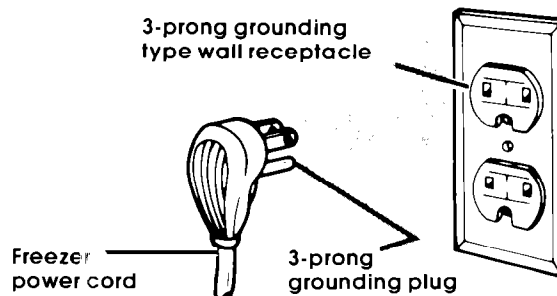

Recommended Grounding Method

A 120 Volt, 60 Hz., AC only, 15 or 20 ampere fused electrical supply is required. It is recommended that a separate circuit serving only this appliance be provided. **The receptacle should not be controlled by a wall switch or pull chain.**

**Do not use an extension cord.**

See individual electrical requirements and grounding instruction sheet in your literature package.

## Using your freezer

### Setting the Cold Control...

To start, turn control to the middle of the dial. This setting will maintain zero zone temperatures under normal operating conditions.

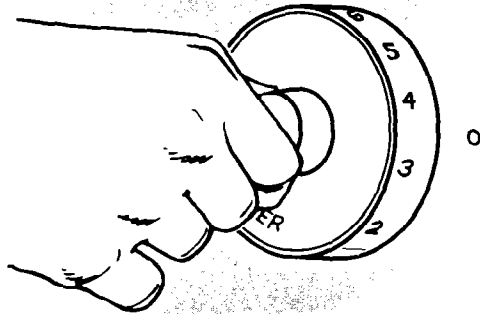

### Adjusting Cold Control...

- Turn control to higher number for colder temperatures.
- Turn to lower number for less cold temperatures.

### Cooling Freezer First...

- Allow freezer to cool 6 to 8 hours before filling with **frozen food**.
- Let it cool overnight before adding large amount of **unfrozen food**.

**Note:** When freezer is first started the compressor will run constantly until the cabinet is cooled. It may take up to 6 to 8 hours or longer, depending on room temperature and the number of times the freezer door is opened.

After the cabinet is cooled the compressor will turn on and off as needed to keep freezer at proper temperature.

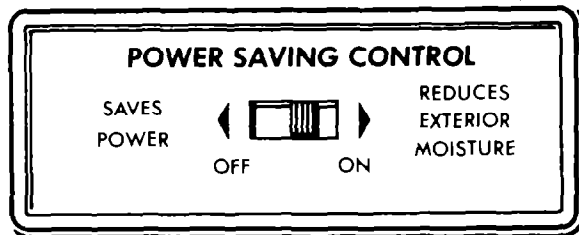

### The Power Saving Control...

operates electric heaters. These heaters help prevent moisture from forming on the outside of the freezer when humidity is high.

- Use the OFF setting when humidity is low to save electricity.
- Use ON only if moisture forms on outside of freezer.

### Exterior Signal Light...

automatically warns of any unexpected power failure.

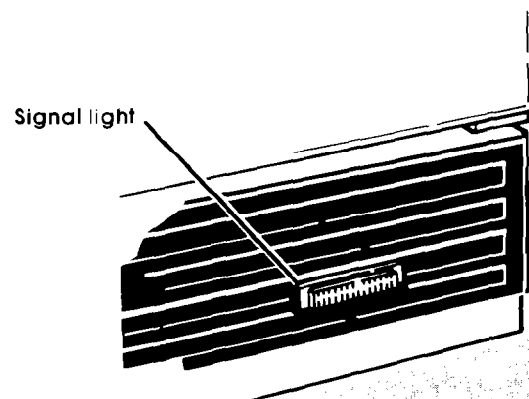

If the signal light is not glowing, immediately check:

- for power interruption,
- the power cord; it may be disconnected from the outlet,
- the signal light; it may be burned out.

### To replace burned out signal light:

1. Unplug power cord from outlet.
2. Remove base grille. See page 4.

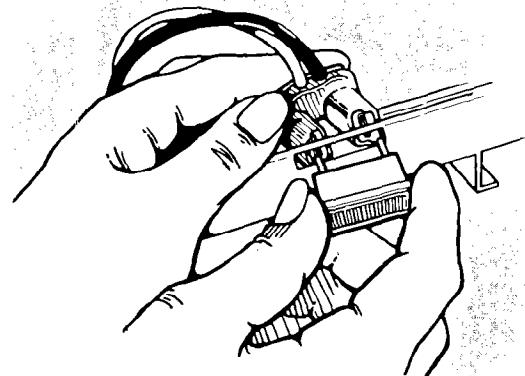

3. Unplug burned out light and replace with one of same wattage and size. Signal light can be ordered from your WHIRLPOOL dealer, Part No. 530584.
4. Replace base grille. See page 4.
5. Plug power cord into outlet.

BEFORE USING YOUR FREEZER

USING YOUR FREEZER

## The Key Eject Lock...

can help reduce the hazard of child entrapment.

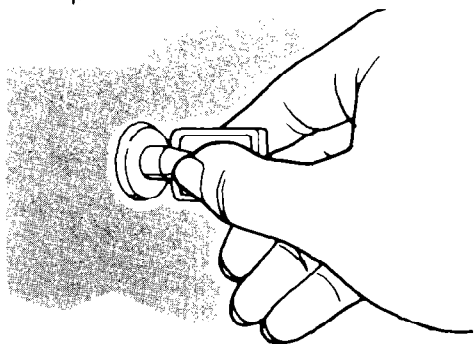

To lock or unlock the freezer you must hold the key in the lock while turning. The lock is spring loaded so the key cannot be left in the lock.

If the key is lost, contact your WHIRLPOOL dealer for a replacement. Always give the **complete** model and serial number of your freezer when requesting a replacement key.

## Freezer Shelves...

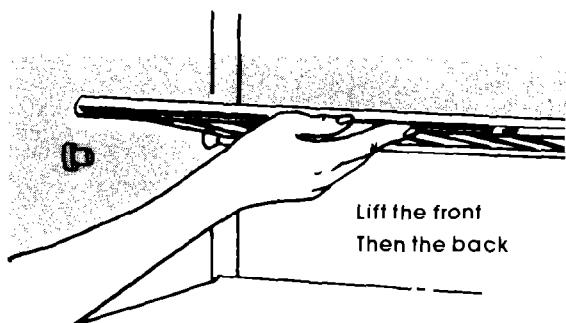

To remove:

Lift front slightly, then lift shelf from back supports.

To replace:

Set back of shelf on rear supports then lower the front on to front mounts.

## Bottom Trivet...

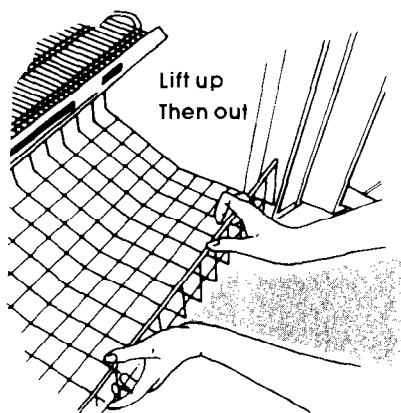

To remove:

- Lift up, then pull out.

To replace:

- Set in bottom of freezer.
- Push into place.

## Changing Light Bulb...

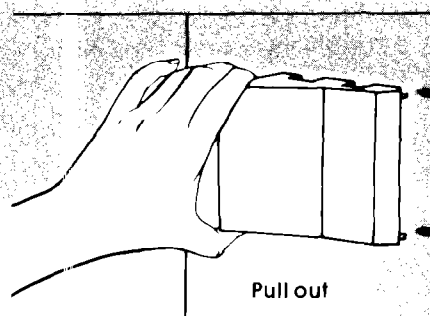

1. Unplug power cord.
2. Remove light shield by pulling away from the side wall.
3. Replace bulb with 40 watt appliance bulb.
4. To replace shield, insert tabs into slots in wall and press.

## To Remove Base Grille...

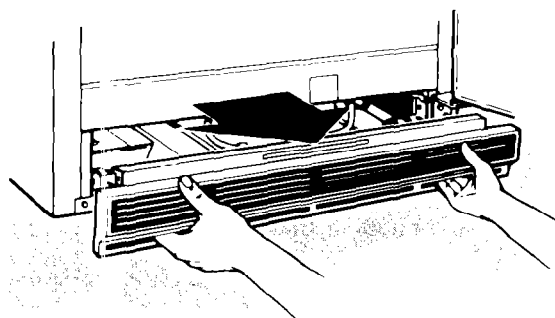

- Open the door.
- Pull grille outwards as shown.

## To Replace Base Grille...

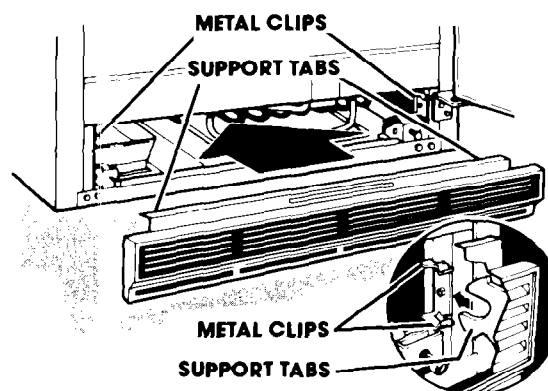

- Line up grille support tabs with metal clips.
- Push firmly to snap into place.
- Close the door.
- **Do not remove Tech Sheet** fastened behind the grille.

# Cleaning your freezer

This freezer is a No-Frost model and defrosts automatically. Complete cleaning, however, should be done at least once a year.

## To clean:

1. Turn Cold Control to OFF.
2. Unplug power cord.
3. Remove food.

**Note:** Wrap frozen foods and packages in several layers of newspaper and cover with a blanket. Food will stay frozen several hours.

4. Remove shelves and trivet.
5. Clean freezer according to the following directions.

## After cleaning:

1. Replace shelves and trivet.
2. Plug in power cord.
3. See directions for "Setting the Cold Control," page 3.

Part	What to use	How to clean
Removable parts (shelves, trivet, etc.)	Mild detergent and warm water	<ul style="list-style-type: none"> <li>• Wash removable parts with warm water and a mild detergent.</li> <li>• Rinse and dry.</li> </ul>
Outside	Sponge, cloth or paper towel; mild detergent; appliance wax (or good auto paste wax).	<ul style="list-style-type: none"> <li>• Wash with warm water and a mild detergent. <b>Do not use abrasive or harsh cleaners.</b></li> <li>• Rinse and dry.</li> <li>• Wax painted metal surfaces at least twice a year with appliance wax or a good auto paste wax. Apply wax with a clean, soft cloth. <b>Do not use wax on plastic parts.</b></li> </ul>
		<b>Waxing painted metal surfaces provides rust protection.</b>
Inside walls (Freezer should be allowed to warm up so cloth won't stick.)	Sponge, soft cloth or paper towel, baking soda, warm water, mild detergent	<ul style="list-style-type: none"> <li>• Wash with warm water and – mild detergent or baking soda solution (2 tablespoons [26 g] baking soda to 1 quart [.95L] warm water).</li> <li>• Rinse and dry.</li> </ul>
Door liner and gasket	Sponge, soft cloth or paper towel; mild detergent, warm water	<ul style="list-style-type: none"> <li>• Wash with mild detergent and warm water.</li> <li>• Rinse and dry.</li> </ul>
		<b>DO NOT USE cleaning waxes, concentrated detergents, bleaches or cleaners containing petroleum on plastic parts.</b>
Drain trough	Baking soda, warm water	<ul style="list-style-type: none"> <li>• Remove trivet.</li> <li>• Pour baking soda solution (2 tablespoons [26 g] baking soda to 1 quart [.95L] warm water) directly into drain trough.</li> </ul>
Defrost pan	Warm water and mild detergent	<ul style="list-style-type: none"> <li>• Remove base grille (see page 4.)</li> <li>• To remove defrost pan, lift pan over wire brace (remove tape; if any).</li> <li>• Wash defrost pan with warm water and mild detergent.</li> <li>• Rinse and dry.</li> <li>• Replace with notched corner to the rear.</li> <li>• Push it all the way in.</li> <li>• Make sure defrost tube is pointing into pan.</li> </ul>
Condenser coil	Vacuum cleaner; using the extended narrow attachment	<ul style="list-style-type: none"> <li>• Remove base grille.</li> <li>• Clean dust and lint from condenser (every 2 to 3 months).</li> <li>• Replace base grille.</li> </ul>

## Freezing food in your freezer



When freezer has cooled to a safe storage temperature, it may be loaded with **frozen food**.

When you plan to freeze **unfrozen food**, see the following chart for the amount to freeze at **one time**.

### POUNDS OF FOOD TO FREEZE AT ONE TIME\*

Size of Freezer	Meat or Fish	Vegetables or Fruit
15 cu. ft. (430 L)	30 lbs. (13.5 kg)	45 lbs. (20.25 kg)

\*These amounts are based on USDA recommendations. If too many packages of unfrozen food are packed at one time into the freezer, the rate of freezing is too slow. Poor quality products result.

### Packaging and Sealing Food...

Airtight packaging is important in freezing foods. Containers and wrappings should be moisture and vapor-proof and packages should be sealed carefully to keep moisture in and air out.

Rigid polyethylene (plastic) containers with tight-fitting lids, straight-sided canning/freezing jars, heavy-duty aluminum foil, plastic-coated paper and non-permeable plastic wraps (such as saran) are recommended. Note: Heat-sealed boiling bags are easy to use and can be used by themselves or as carton liners.

Freezer burn can result if food is not properly wrapped. When this happens food dehydrates and is of poor quality.

### To wrap foods



1. Cut sheet of wrapping material about

one-third longer than distance around food to be wrapped. Place wrapping sheet on flat surface with food in center of sheet.

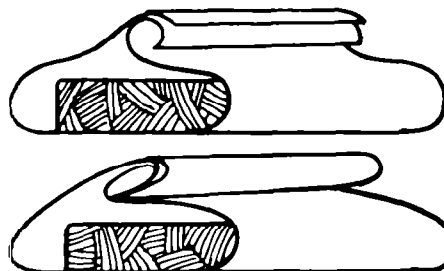

2. Bring front and back of wrapping together and fold in toward food, making at least two one-inch (2.5 cm) folds until food fits tightly against wrapping.

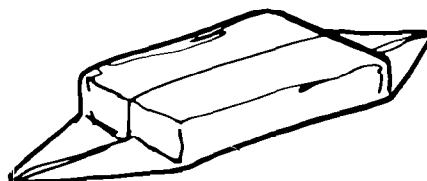

3. Crease ends close to food to eliminate air pockets.



4. Press all air from package. Fold each end over twice. Make sure fold is tight and fasten against end of package with freezer tape.

**NOTE:** When packaging meats that have not been boned, pad sharp edges with extra wrap or use stockinette to protect against tearing or puncturing.

See booklet, "How to Preserve Foods the Modern Way with Your WHIRLPOOL Freezer," for complete information and tips on home freezing.

### Loading...

1. Before freezing large quantities of food, turn Cold Control to highest position and let freezer operate for several hours.
2. To speed freezing, lay packages in a single layer so each rests on the freezing surface of a shelf. Leave space between packages.

3. Add more unfrozen food after first load is frozen (approximately 18 to 24 hours).
4. After all food is frozen, return Cold Control to the usual setting.

### Storing frozen food...

After food is frozen, stack packages anywhere in the freezer. Packages should not extend beyond the shelf edge or they may keep the door from closing and sealing properly.

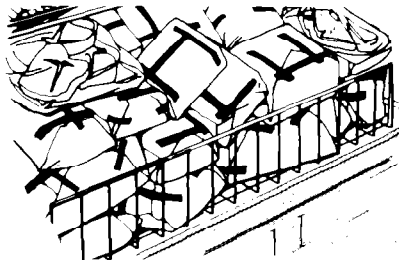

**Trivet** – Store heavy and bulky packages here. Trivet should be in place at all times for proper air circulation.

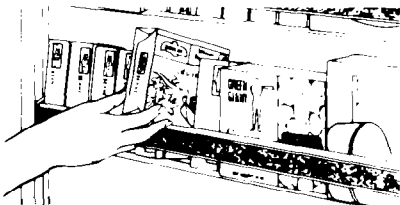

**Door storage** – Store packages on the door shelves behind the retaining bar.

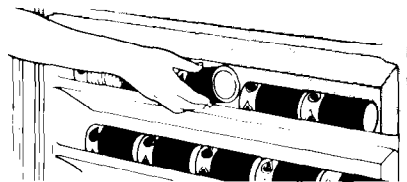

**Juice can shelves** – Store juice cans on door as shown.

### Energy Saving Tips...

- Check door gasket and level freezer to assure a good door seal.
- Keep door openings to a minimum. Remove several items at one time. Keep contents organized to eliminate searching.
- Fill to capacity. Follow recommended procedures for freezing foods.
- Set Cold Control to provide temperatures around 0°F (-22°C). There is no need to store foods below 0°F.
- Keep door locked to insure door closure.
- Clean condenser coils frequently.

## Vacation and moving care



### Vacations...

Arrange for someone to make regular checks of your freezer to make sure it is operating and electricity has not been interrupted.

### Shutting off and moving...

If freezer is shut off for more than 24 hours:

1. Remove and store all food.
2. Unplug freezer.
3. Clean thoroughly. See "Cleaning Your Freezer," page 5.
4. Block door open for air circulation. Turn lock to locked position with door open. Place blocks between door and cabinet and tape in place with self-adhesive filament tape.

#### If you move the freezer:

- Remove shelves and trivet.
- Do not place objects inside cabinet.
- Level properly to insure good door seal.

**CAUTION:** To help prevent accidents, do not allow children near the freezer when the door is blocked open.

To restart freezer, see "Using your freezer," page 3.

## If you need service or assistance, we suggest you follow these four steps:

### 1. Before calling for assistance...

Performance problems often result from little things you can find and fix yourself without tools of any kind.

#### If electricity goes off:

Learn how long power will be off by calling the power company.

- If service is to be interrupted 24 hours or less, keep freezer closed. Most food will stay frozen.

- If service is to be interrupted longer than 24 hours, do this:
  1. Remove all frozen food and store in a frozen food locker. Or...
  2. Place dry ice on top of food, using as large pieces as possible. Protect your hands with gloves when using dry ice.
  3. If neither food locker storage or dry ice is available, use or can perishable food at once.
- The length of time food will stay frozen depends on several factors. For instance: a full freezer will remain cold longer than a freezer only partially filled. And a freezer full of meat will stay cold longer than a freezer filled with baked goods. Also, if the food still contains ice crystals, it may be safely refrozen, although the quality and flavor may be affected. Use this food as soon as convenient. If the condition of the food is poor or is in any way questionable, it is wise to dispose of it.

**If freezer stops running:**

- Check to see if power cord is plugged into the outlet.
- Check fuse box or circuit breaker.
- Check electric company for a power failure.
- Be sure COLD CONTROL is turned on.

**If compressor seems to run too long:**

- Check to see that condenser, behind the base grille, is free of dust and lint.
- On hot summer days or if room is hot, compressor will run longer to provide correct amount of cooling.
- If large amounts of unfrozen food have been put into the freezer, compressor will run longer.

**2. If you need assistance\* ...**

Call Whirlpool COOL-LINE® service assistance telephone number. Dial free from:

**Continental U.S. .... (800) 253-1301**  
**Michigan ..... (800) 632-2243**  
**Alaska & Hawaii ..... (800) 253-1121**

and talk with one of our trained Consultants. The Consultant can instruct you in how to obtain satisfactory operation from your appliance or, if service is necessary, recommend a qualified service company in your area.

**3. If you need service\* ...**



Whirlpool has a nationwide network of franchised TECH-CARE® Service Companies. TECH-CARE service technicians are trained to fulfill the product warranty and provide after-warranty service, anywhere in the United States. To locate

TECH-CARE service in your area, call our COOL-LINE service assistance telephone number (see Step 2) or look in your telephone directory Yellow Pages under:

<b>APPLIANCES - HOUSEHOLD - MAJOR - SERVICE &amp; REPAIR</b>	<b>OR</b>	<b>ELECTRICAL APPLIANCES - MAJOR - REPAIRING &amp; PARTS</b>
WHIRLPOOL APPLIANCES FRANCHISED TECH-CARE SERVICE		WHIRLPOOL APPLIANCES FRANCHISED TECH-CARE SERVICE
<i>SERVICE COMPANIES</i>		
XYZ SERVICE CO 123 Maple ..... 999-9999		XYZ SERVICE CO 123 Maple ..... 999-9999
<b>OR</b>		
<b>WASHING MACHINES, DRYERS &amp; IRONERS - SERVICING</b>		
WHIRLPOOL APPLIANCES FRANCHISED TECH-CARE SERVICE		
<i>SERVICE COMPANIES</i>		
XYZ SERVICE CO 123 Maple ..... 999-9999		

**4. If you have a problem\* ...**

Call our COOL-LINE service assistance telephone number (see Step 2) and talk with one of our Consultants, or if you prefer, write to:

Mr. Guy Turner, Vice President  
 Whirlpool Corporation  
 Administrative Center  
 2000 U.S-33 North  
 Benton Harbor, MI 49022

\*If you must call or write, please provide: model number, serial number, date of purchase, and a complete description of the problem. This information is needed in order to better respond to your request for assistance.



FSP is a registered trademark of Whirlpool Corporation for quality parts. Look for this symbol of quality whenever you need a replacement part for your Whirlpool appliance. FSP replacement parts will fit right and work right, because they are made to the same exacting specifications used to build every new Whirlpool appliance.



**Benton Harbor, Michigan. Automatic Washers, Clothes Dryers, Freezers, Refrigerator-Freezers, Ice Makers, Dishwashers, Built-in Ovens and Surface Units, Ranges, Microwave Ovens, Compactors, Room Air Conditioners, Dehumidifiers, Central Heating and Air Conditioning Systems.**



## Free Manuals Download Website

<http://myh66.com>

<http://usermanuals.us>

<http://www.somanuals.com>

<http://www.4manuals.cc>

<http://www.manual-lib.com>

<http://www.404manual.com>

<http://www.luxmanual.com>

<http://aubethermostatmanual.com>

Golf course search by state

<http://golfingnear.com>

Email search by domain

<http://emailbydomain.com>

Auto manuals search

<http://auto.somanuals.com>

TV manuals search

<http://tv.somanuals.com>