

Use and Care Guide

Vertical Freezer

TVF15FR

Thank you for choosing an Estate appliance.

This Use and Care Guide will help you operate and maintain your new, quality-built Estate vertical freezer. Keep this Use and Care Guide in a safe place for future reference.

Please complete and mail the Product Registration Card. Then complete the form below. Have this information ready if you need service or call with a question.

- Copy model and serial numbers from label (see diagram on page 3) and purchase date from sales slip.
- Keep this book and sales slip together in a handy place.

Model Number

Serial Number

Purchase Date

Service Company Phone Number

You are responsible for

It is your responsibility to be sure your freezer:

- Is properly installed and leveled on a floor that will hold the weight, and in an area suitable for its size and use.
- Is properly connected to a grounded electrical circuit that meets the electrical requirements on page 2.
- Is used only for the job it was designed to do.
- Is not near an oven, radiator or other heat source.
- Is properly maintained.
- Is out of the weather.
- Is used in an area where the temperature will not exceed 110°F (43.3°C) or drop below 55°F (13°C).
- Is not used by children or anyone unable to operate it properly.
- Is not loaded with food before it has time to get properly cold.

Contents

	Page
Important Safety Instructions	2
Food Storage	2
Before Using Your Freezer	2
Using Your Freezer	3
Setting the temperature control	3
Adjusting the temperature control	3
Refrigerated shelves	4
Lower storage gate	4
The key eject lock	4
Cleaning And Caring For Your Freezer	4
Defrosting and cleaning	4
If electricity goes off	4
Moving	4
Before You Call For Service	5
If You Need Assistance, Service or Replacement Parts	5
Warranty	6
Limited domestic food loss coverage	6

5/12

Important Safety Instructions

⚠ WARNING

To reduce the risk of fire, electrical shock, or injury when using your freezer, follow basic precautions including the following:

1. Read all operating instructions before using your freezer.
2. Child entrapment and suffocations are not problems of the past. Junked or abandoned freezers are still dangerous...even if they will "just sit in the garage for a few days."
If you are getting rid of your old freezer, do it safely. Please read the enclosed safety booklet from the Association of Home Appliance Manufacturers. Help prevent accidents.
3. Never allow children to operate, play with, or crawl inside the freezer.
4. Never clean freezer parts with flammable fluids. The fumes can create a fire hazard or explosion.

• FOR YOUR SAFETY •
DO NOT STORE OR USE GASOLINE OR OTHER FLAMMABLE VAPORS AND LIQUIDS IN THE VICINITY OF THIS OR ANY OTHER APPLIANCE. THE FUMES CAN CREATE A FIRE HAZARD OR EXPLOSION.

SAVE THESE INSTRUCTIONS

Food Storage

Your freezer is designed for storage of commercially frozen food and for freezing food at home. For further information about preparing food for freezing or food storage times, contact your local Cooperative Extension Service or check a freezer guide or cookbook.

Before Using Your Freezer

A. Remove packing materials

Remove materials, tape and inside labels before using the freezer. To remove any remaining glue:

- Rub briskly with thumb to make a ball, then remove.
- OR
- Soak area with liquid hand dishwashing detergent before removing glue as described above.

Do not use sharp instruments, rubbing alcohol, flammable fluids or abrasive cleaners. These can damage the material. See "Important Safety Instructions" at left.

NOTE: Do not remove the Tech Sheet located on the back of the freezer.

B. Install handle

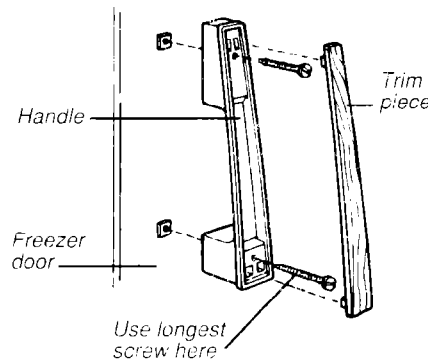

1. Remove screws from front of freezer door and discard
2. Locate handle assembly kit among packing materials.
3. Attach top of handle to top hole in door with shorter of 2 screws provided.
4. Attach bottom of handle to lower hole in door with longer of 2 screws
5. Snap trim piece into place.

C. Clean it

Clean your freezer before using it

1. Use a sponge, cloth or paper towel and mild detergent in warm water to clean outside and inside of freezer, door liner and gasket.
2. Rinse and dry thoroughly.

D. Locate proper electrical supply

Recommended Grounding Method

A 115 Volt, 60 Hz., AC only 15 or 20 ampere fused and properly grounded electrical supply is required. It is recommended that a separate circuit serving only this appliance be provided. Use a receptacle which cannot be turned off with a switch or pull chain. Do not use an extension cord.

Attach retaining clip, from literature package inside the freezer, over power cord plug.

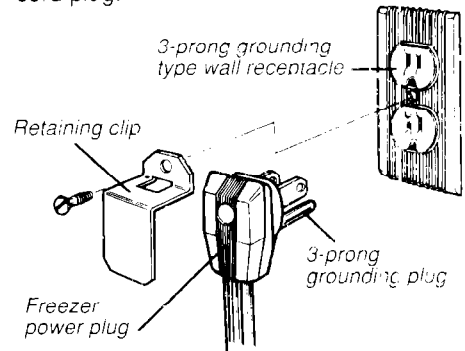

E. Choose freezer location

1. Pick a safe place, indoors, away from flammables such as gasoline.
2. Check the strength of the floor. It should hold the weight of a fully loaded freezer.
3. Allow at least 3 inches (7.5 cm) of air space at top of freezer.
4. Allow at least 1 inch (2.5 cm) between back of freezer and the wall.
5. Allow 1/2 inch (1.25 cm) on each side of the freezer for ease of installation.
6. If the freezer is to be against a wall, you might want to leave extra space on the hinge side so the door can be opened wider.

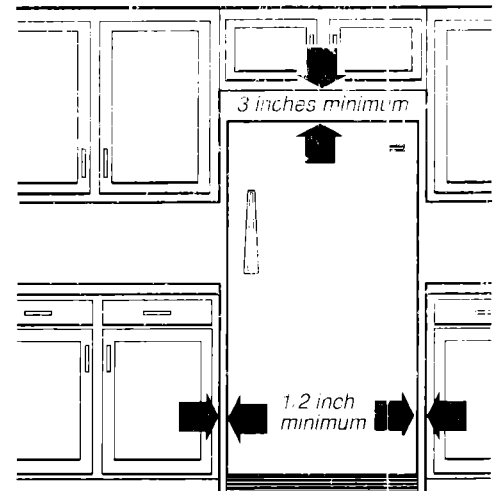

Using Your Freezer

F. Install and level freezer

Level freezer so the door will stay open at any position.

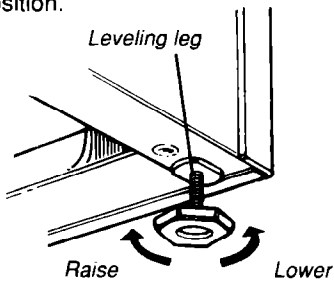

1. Locate, remove and discard the 4 bolts that held the freezer in the shipping crate.
2. Locate the 2 front leveling legs among the packing materials.
3. Screw these legs into the front holes on the bottom of the freezer. The back of the freezer rests on 2 fixed supports.
4. Adjust the 2 front legs so freezer does not rock.
5. Connect freezer to proper electrical supply and attach retaining clip. (Refer to "D. Locate proper electrical supply" on page 2.)
6. Slide freezer into place.
7. Place a level on top of the freezer – first side to side then front to back. Turn leg clockwise to raise a corner. Turn leg counter-clockwise to lower a corner.
8. Repeat step 7 until the freezer is level.
9. After freezer is fully loaded, recheck with level.

Model and serial number label (on side wall)

Temperature control

Refrigerated stationary shelves

Lower storage gate

Base grille

Leveling legs (not shown)

Stationary door shelves

Key eject lock

Setting the temperature control

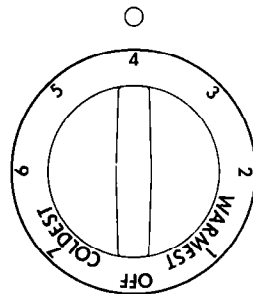

Turn the control to 4. This setting is designed to maintain the temperature at or near 0°F (-17.8°C) under normal operating conditions.

Allow the freezer to cool 6 to 8 hours before filling with **frozen food**. Let the freezer cool overnight before adding large amounts of **unfrozen food**. Never add more than 2-3 pounds of unfrozen food per cubic foot of freezer space.

NOTE: When the freezer is first started, the compressor will run constantly until the cabinet is cooled. It may take up to 6 to 8 hours or longer, depending on room temperature and the number of times the freezer door is opened.

After the cabinet is cooled, the compressor will turn on and off as needed to keep the freezer at the proper temperature.

The outside of your freezer may feel warm. This is normal. The freezer's design and main function is to remove heat from packages and air space inside the freezer. This heat is transferred to the room air, so the outside of the freezer may feel warm.

Adjusting the temperature control

- Turn control to a higher number for colder temperatures.
- Turn control to a lower number for less cold temperatures.

Refrigerated shelves

Your freezer is equipped with refrigerated interior shelves. Packages in direct contact with the shelves will have the best refrigeration. Fresh, unfrozen food packages should be stored directly on the shelves and not on top of already frozen food packages.

When placing the food packages in your freezer, it should be remembered:

- The cabinet shelves have the best freezing capability. The door shelves and the bottom of the cabinet have a slightly higher temperature. Therefore, packages sensitive to temperature (meat, poultry, etc.) should not be placed on the door shelves or the freezer bottom.
- Give the cold air a chance to completely surround the packages.

Lower storage gate

Pull top up, then forward.

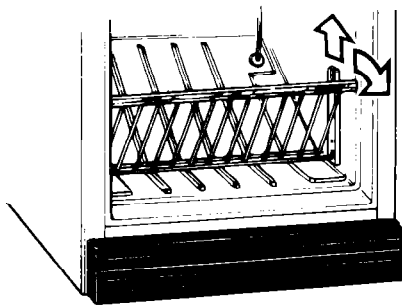

To lower gate:

1. Lift top of gate up slightly to clear supports.
2. Pull gate forward.

To raise gate:

1. Return gate to upright position.
2. Lift top of gate slightly to clear supports.
3. Lower gate into supports.

The key eject lock

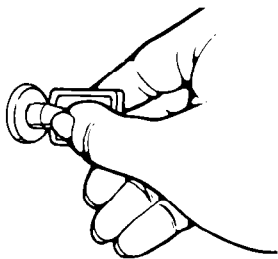

Because your freezer is equipped with a lock, it can help reduce the hazard of child entrapment.

To lock or unlock the freezer, you must hold the key in the lock while turning. The lock is spring loaded, so the key cannot be left in the lock.

If the key is lost, contact your Estate dealer for a replacement. Always give the complete model and serial number of your freezer when requesting a replacement key.

Cleaning And Caring For Your Freezer

Defrosting and cleaning

Defrost and clean your freezer when frost has built up to about 1/4 inch (6 mm) thickness. Complete defrosting and cleaning should be done at least once a year. In high humidity areas, a freezer may need more frequent defrosting and cleaning.

⚠ WARNING

Electrical Shock and Product Damage Hazard

- Turning the Temperature Control to OFF does not remove power to the unit. Failure to unplug the power cord before cleaning or servicing unit could result in electrical shock.
- Do not place electrical devices in freezer when defrosting. Shock or injury can occur.
- Do not use an ice pick, knife or other sharp-pointed tool to defrost freezer. Damage can occur.
- Do not use abrasive cleaners on your freezer. Do not use cleaning waxes, concentrated detergents, bleaches or cleaners containing petroleum on plastic parts. Damage can occur.

1. Turn Temperature Control to OFF and unplug power cord.
2. Remove all frozen food. Wrap frozen food in several layers of newspaper and cover with a blanket. Food will stay frozen for several hours.
OR
Store frozen food in a cooler, additional refrigerator-freezer, or in a cool area.
3. Place pans of hot water in freezer with door open to speed melting. Directing air from an electric fan into freezer will also help. **Do not place fan in freezer.**
4. Use a plastic scraper to remove frost.
5. Wipe water from walls and bottom of freezer with a towel or sponge.
6. Wash the inside walls with a solution of 2 tablespoons (26 mg) baking soda to 1 quart (0.95 L) warm water.
7. Rinse and dry thoroughly.
8. Use a sponge, cloth or paper towel and mild detergent in warm water to clean outside of freezer, door liner and gasket.
9. Rinse and dry thoroughly.

10. Wax painted metal surfaces outside of freezer to provide rust protection.

NOTE: Do not use wax on plastic parts. Wax may damage them.

11. Replace all frozen food.
12. Plug in power cord and refer to "Setting the temperature control" on page 3.

If electricity goes off

1. Call the power company.

Ask how long power will be off.

2. Keep freezer closed if service is to be interrupted 24 hours or less.

This will help food to stay frozen.

3. If service is to be interrupted longer than 24 hours, do this:

Remove all frozen food and store in a frozen food locker.

OR

Place 2 lbs. (0.9 kg) of dry ice in freezer for every cubic foot of freezer space. This will keep foods frozen for 2 to 4 days.

⚠ WARNING

Personal Injury Hazard

Wear gloves to protect your hands from dry ice burns. Failure to do so could result in dry ice burns.

OR

If dry ice or a food locker is not available, use or can perishable food at once.

NOTE: A full freezer stays cold longer than a partly filled one. A freezer full of meat stays cold longer than a freezer full of baked goods.

Food containing ice crystals may be safely refrozen, but the quality and flavor of the food may be affected.

Use refrozen food quickly. If the condition of the food is poor, or you feel it is unsafe to eat, dispose of it immediately.

Moving

Remove all frozen food and pack it in dry ice. Unplug the freezer and clean it thoroughly. Tape the door shut and tape electrical cord to the cabinet.

When you get to your new home, refer to pages 2 and 3 for information on installation and setting controls.

Before You Call For Service

If you are having an operating problem, check the chart to see what the cause might be before you call for assistance.

OPERATING PROBLEM	CHECK IF	WHAT TO DO
Freezer will not run	<ul style="list-style-type: none"> Power cord is plugged into a live circuit with proper voltage. Fuse has blown or circuit breaker has tripped. Also check if a time-delay fuse has been used. Electricity has failed. Temperature Control is turned on. 	<ul style="list-style-type: none"> Firmly plug power cord into electrical outlet. Check circuit voltage at fuse/circuit breaker box. Replace fuse with a time-delay fuse of the correct capacity. Reset circuit breaker. See "If electricity goes off" on page 4. Turn Temperature Control to a numbered position.
Motor runs too long or temperature is too warm	<ul style="list-style-type: none"> Power cord is plugged into a live circuit with proper voltage. Excessive frost or a package is holding the door open. Large amounts of unfrozen food have been added to the freezer. Weather is hot and muggy. There is enough air circulation space above and behind the freezer. 	<ul style="list-style-type: none"> Firmly plug power cord into electrical outlet. Check circuit voltage at fuse/circuit breaker box. Defrost freezer or reposition package. Add no more than 2 to 3 pounds of unfrozen food per cubic foot of freezer space at a time. Adding large amounts of unfrozen food will cause the motor to run longer. If the temperature outside or inside the room is warm, motor running longer is normal. Freezer should not be used in an area where the temperature exceeds 110°F (43.3°C). Allow at least 3 inches (7.5 cm) air space on top of freezer and 1 inch (2.5 cm) at back for proper air circulation.
Freezer clicks but does not run	<ul style="list-style-type: none"> Electricity failed and has been restored. 	<ul style="list-style-type: none"> Unplug the freezer for 30 minutes to allow the refrigeration system to equalize.

If You Need Assistance, Service Or Replacement Parts

If you need service, first see the "Before You Call For Service" section of this book. After checking "Before You Call For Service," additional help can be found by calling our COOL-LINE® service assistance telephone number.

1. If you need assistance*...

Call Whirlpool COOL-LINE® service assistance telephone number. Dial free from anywhere in the U.S.:

1-800-253-1301

and talk with one of our trained consultants. The consultant can instruct you in how to obtain satisfactory operation from your appliance or, if service is necessary, recommend a qualified service company in your area.

If you prefer, write to:

Mr. Donald Skinner
 Director of Consumer Relations
 Whirlpool Corporation
 2000 M-63
 Benton Harbor, MI 49022

Please include a daytime phone number in your correspondence.

2. If you need service*...



Whirlpool has a nationwide network of authorized WhirlpoolSM service companies.

Whirlpool service technicians are trained to fulfill the product warranty and provide after-warranty service, anywhere in the United States. To locate the authorized Whirlpool service company in your area, call our COOL-LINE® service assistance telephone number (see Step 1) or look in your telephone directory Yellow Pages under:

APPLIANCES - HOUSEHOLD -
 MAJOR - SERVICE & REPAIR
 OR
 ELECTRICAL APPLIANCES -
 MAJOR - REPAIRING & PARTS
 OR
 WASHING MACHINES, DRYERS
 & IRONERS - SERVICING
 WHIRLPOOL APPLIANCES
 AUTHORIZED WHIRLPOOL SERVICE
 SERVICE COMPANIES
 XYZ SERVICE CO
 123 Maple... 999-9999

3. If you need FSP® replacement parts*...

FSP is a registered trademark of Whirlpool Corporation for quality parts. Look for this symbol of quality whenever you need a replacement part for your Estate appliance. FSP replacement parts will fit right and work right, because they are made to the same exacting specifications used to build every new Estate appliance.

To locate FSP replacement parts in your area, refer to Step 2 above or call the Whirlpool COOL-LINE service assistance number in Step 1.

4. If you are not satisfied with how the problem was solved*...

- Contact the Major Appliance Consumer Action Panel (MACAP). MACAP is a group of independent consumer experts that voices consumer views at the highest levels of the major appliance industry.

(Continued on next page)

- Contact MACAP only when the dealer, authorized servicer or Whirlpool have failed to resolve your problem:
Major Appliance Consumer Action Panel
20 North Wacker Drive
Chicago, IL 60606
- MACAP will in turn inform us of your action.

*When requesting assistance, please provide: model number, serial number, date of purchase, and a complete description of the problem. This information is needed in order to better respond to your request.

ESTATE[®] Freezer Warranty

FZE04

LENGTH OF WARRANTY	WHIRLPOOL WILL PAY FOR
FULL ONE-YEAR WARRANTY From Date of Purchase	FSP [®] replacement parts and repair labor to correct defects in materials or workmanship.
FULL FIVE-YEAR WARRANTY From Date of Purchase	FSP [®] replacement parts and repair labor to correct defects in materials or workmanship in the sealed refrigeration system. These parts are: 1. Compressor 2. Evaporator 3. Condenser 4. Drier 5. Connecting tubing
WHIRLPOOL WILL NOT PAY FOR	
<p>A. Service calls to:</p> <ol style="list-style-type: none"> 1. Correct the installation of the freezer. 2. Instruct you how to use the freezer. 3. Replace house fuses or correct house wiring or plumbing. 4. Replace light bulbs or batteries. <p>B. Pick up and delivery. This product is designed to be repaired in the home.</p> <p>C. Damage to freezer caused by accident, misuse, fire, flood, acts of God or use of products not approved by Whirlpool.</p> <p>D. Food loss coverage for freezers used in commercial applications.</p>	

WHIRLPOOL CORPORATION SHALL NOT BE LIABLE FOR INCIDENTAL OR CONSEQUENTIAL DAMAGES. Some states do not allow the exclusion or limitation of incidental or consequential damages so this limitation or exclusion may not apply to you. This warranty gives you specific legal rights, and you may also have other rights which vary from state to state. Outside the United States, a different warranty may apply. For details, please contact your authorized Whirlpool distributor or military exchange.

Limited domestic food loss coverage reimbursement for food losses

During the first year of ownership, the Estate Freezer warranty provides reimbursement as outlined below for food actually spoiled while stored in the freezer as a result of defects in materials or workmanship.

During the second through fifth years of ownership, reimbursement will be made as outlined below for food actually spoiled while stored in the freezer as a result of a **FAILURE OF THE SEALED REFRIGERATION SYSTEM**.

Food spoilage losses must be verified by Whirlpool or an authorized WhirlpoolSM service company. Reimbursement of loss will be based on domestic use up to the total cumulative amount of \$125.00 maximum payment for the five year warranty period.

This reimbursement amount may or may not cover the actual replacement cost of the contents of your freezer. It is the maximum amount, however, that will be paid and it is cumulative for the five year warranty period.

Sorry, but Whirlpool is not responsible for food losses caused by natural spoilage, misuse or negligent care of the freezer, or by accidental or intentional disconnecting of the electric power cord, power interruption, inadequate power, fire damage, water damage, theft, or riots, strikes, war or acts of God.

— NOTES —

Free Manuals Download Website

<http://myh66.com>

<http://usermanuals.us>

<http://www.somanuals.com>

<http://www.4manuals.cc>

<http://www.manual-lib.com>

<http://www.404manual.com>

<http://www.luxmanual.com>

<http://aubethermostatmanual.com>

Golf course search by state

<http://golfingnear.com>

Email search by domain

<http://emailbydomain.com>

Auto manuals search

<http://auto.somanuals.com>

TV manuals search

<http://tv.somanuals.com>