

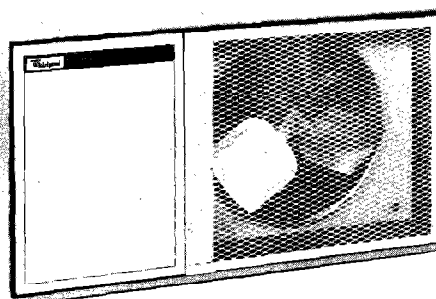

Whirlpool

AUTOMATIC ICE CUBE MAKER

User's Instructions & Care and Cleaning Guide

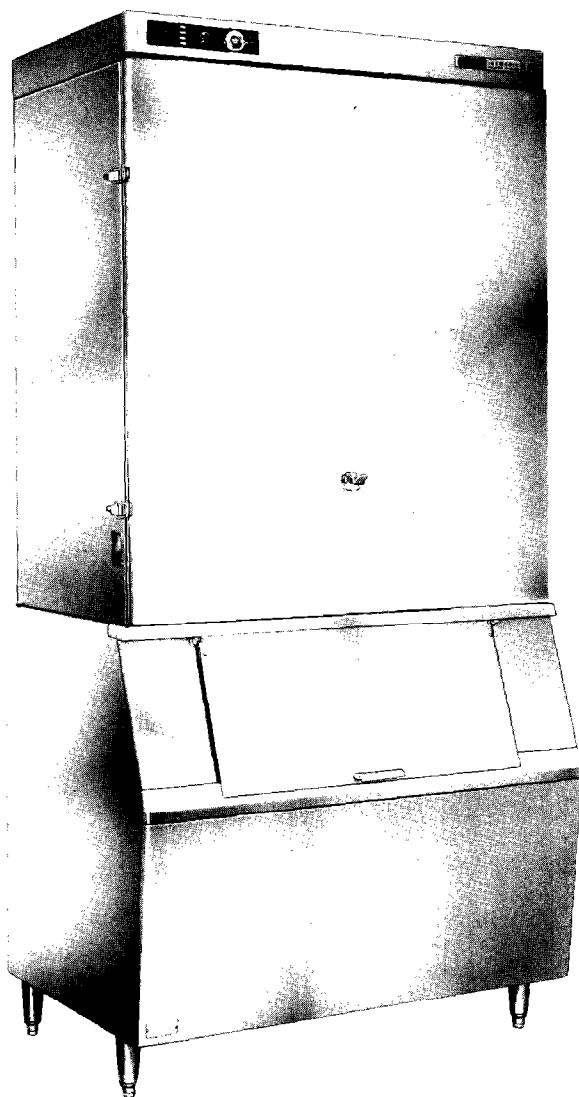

MODEL – CHS-12RC
CHS-12RS
CHE-12RC
CHE-12RS

General Information

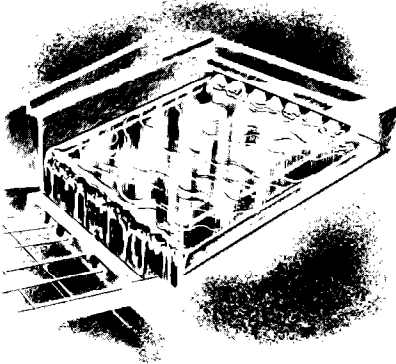

The machine produces clear hard ice by circulating water over a freezing plate. As the water freezes into ice, minerals in the water are constantly being rejected and a clear sheet of ice is formed.

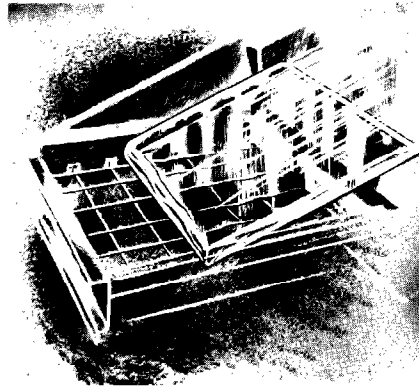

When the desired thickness is reached, the ice sheets are released and slide onto a cutter grid where the sheet is divided into individual cubes. At the end of each freezing cycle the water containing the rejected minerals is discharged to the drain. Fresh water then enters the machine for the next ice making cycle.

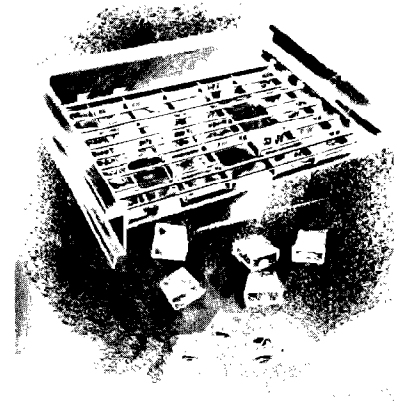

Cubes fall into the storage bin. When the bin is full the ice maker shuts off automatically and restarts when the ice supply needs replenishing.

SERVICE SWITCH

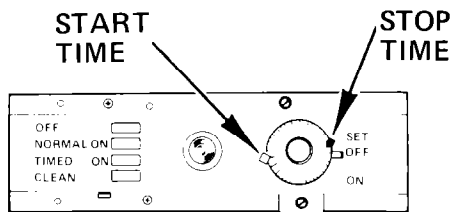

The push button switch located on the control panel at the top of the machine has four selections. The "normal on" position is used when maximum ice production and full bin capacity is needed. The "timed on" position is used in conjunction with the "production volume control" timer. The "clean" position is used whenever solutions are circulated through the water system for scale removal or sanitizing. At the "clean" position, only the water pump operates. The "off" position shuts the entire machine off.

PRODUCTION CONTROL TIMER

Operation of the machine will normally require setting the selector switch to the "normal on" position. With this setting daily ice usage should be great enough to completely empty the ice storage bin at least once. If this type of usage does not occur, the ice left in the storage bin will have a tendency to cluster or freeze in chunks making ice difficult to remove from the bin.

The purpose of the timer control is to allow a user to tailor the daily ice production of the machine to the user's ice requirements. This prevents an excess of stored ice with the resulting ice clustering problem.

Once the timer and switch is set, daily operation is automatic and need not be adjusted or changed unless ice requirements change.

Operation of the machine can be tailored to the user's needs in the following manner.

1. Set the timer to the present time of day within the proper day or night portion of the control dial.
2. Set the "time to start" knob (white) to the hour at which machine operation is to begin. The knob must be depressed slightly and then rotated around the timer bezel to the time setting selected.
3. Set the "time to stop" knob (black) to the hour at which machine operation is to terminate.
4. Set the push button service switch to the "timed on" position. The start time should be selected to allow the machine to produce enough ice for "start up" requirements. The "off time" should be selected to allow the machine to produce enough ice needed for the entire day.

SIGNAL LIGHT

With the selector switch in the "normal on" or "timed on" position the signal light will glow with a low intensity and is an indication that the electrical power is on.

When the harvest cycle is longer than three minutes the signal light becomes brighter and begins to blink. This indicates a malfunction of the harvest cycle.

NOTE: The machine will generally resume normal operation within a period of twenty (20) minutes after such a malfunction does occur. If the signal light repeats indicating a malfunctioning harvest cycle, a qualified serviceman should check the machine.

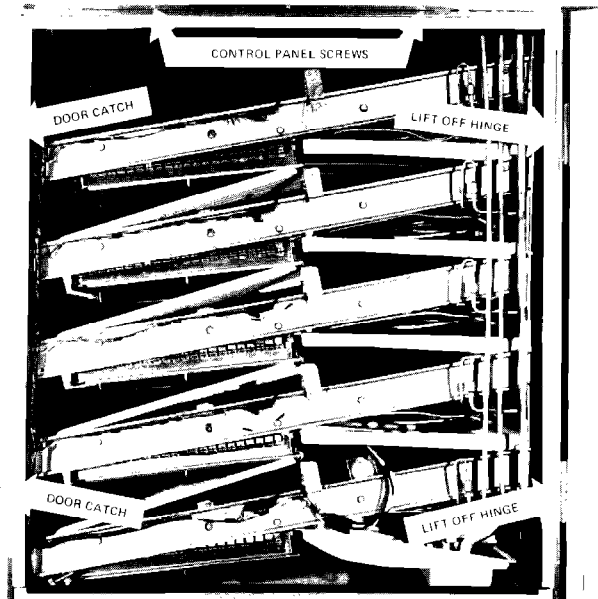

4. Unlatch the two snap catches and swing the front panel open on its hinges. If there is inadequate clearance to swing the panel open, the front panel can also be lifted off the hinges. The control panel cover may have to be removed to lift the front panel off its hinges. Remove the cover by removing the screws along the bottom front edge. The cover then pulls straight off.

CAUTION: Always disconnect electrical power to the machine when removing the control panel cover.

The front panel then need only be cracked open to lift it off the hinges. Temporarily replace the control panel cover as power must be provided to continue the cleaning operation.

5. With electrical power on and the service switch set to the "normal on" position, proceed to:
 - A. Shut off the water supply to the machine.
 - B. Lift up gently on the thickness control arm until the water has drained out of the reservoir pan and all ice sheets are off the freezing plates.
 - C. Release the thickness control and set the service switch to the "clean" position.

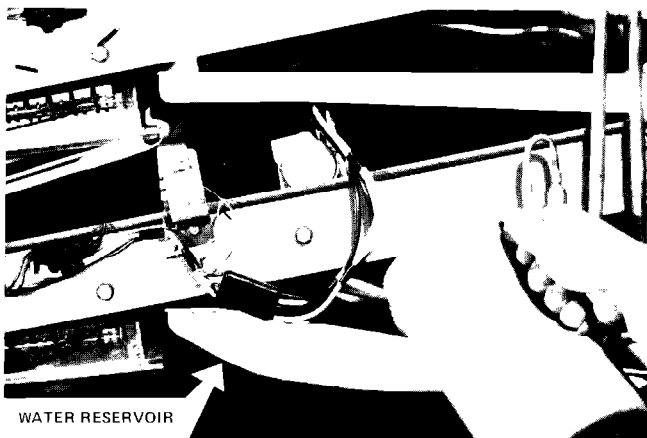

6. Preheat the water system by pouring hot water into the reservoir pan until the lower pump housing is covered.

Circulate for five minutes. Then set service switch to "off" position to syphon out the water.

7. Set service switch to "clean" position. Slowly pour the cleaning solution into the water reservoir pan. If the solution foams, stop pouring until the foam subsides and then pour the rest of the solution.
8. Allow the solution to circulate until the scale on the freezing plate surface has dissolved.
9. When the plates are clean, place the service switch in the "off" position. This allows the cleaning solution to syphon out of the reservoir pan into the drain.

NOTE: Severe scale formation on the freezing plates may require repeating the cleaning process with a fresh quantity of solution if after 20 to 30 minutes of circulating all the scale deposits are not removed.

If scale deposits remain on the side flanges a stainless steel sponge or pad dipped in cleaning solution can be used to scrub these surfaces. This can best be accomplished after the removal of the lower water distributors. (see steps 14 & 15)

10. Turn on the water supply to the machine and set the service switch to "clean". Allow the fresh water to circulate for ten minutes.
11. Place the service switch in the "off" position and allow the water to syphon off to the drain. When the reservoir pan has refilled with water, place the service switch in the "clean" position and allow the water to circulate for ten more minutes.
12. Place the service switch in the "off" position and allow the water to syphon off to the drain.

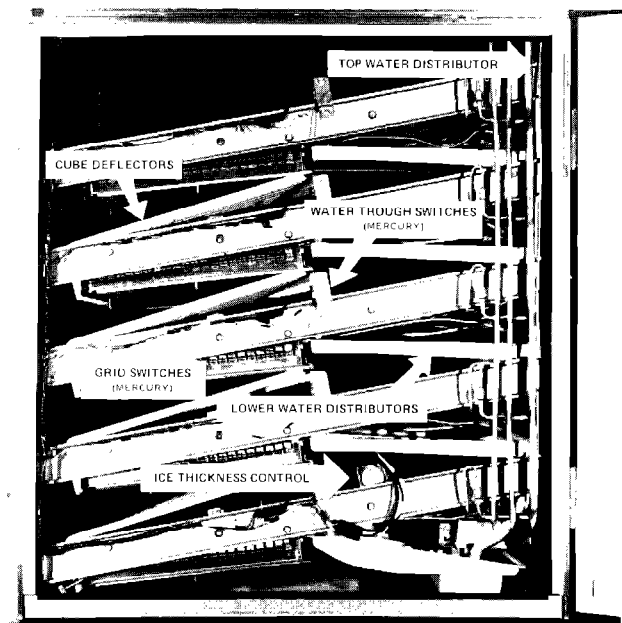

13. Remove the top water distributor tube. Remove the two wing nuts which hold the distributor tube in position on the top freezing plate. Pull out the water pump hose from the right end of the distributor. Pull out the rubber plug from the left end of the distributor. A stiff bristled brush of approximately the same diameter as the distributor will facilitate removal of scale accumulation.

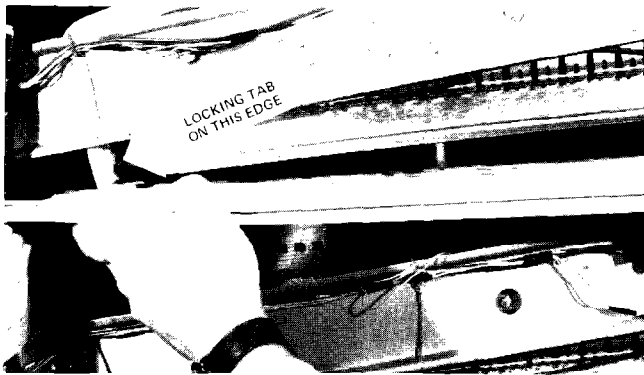

14. Remove the ice cube deflectors between each cutter grid. The lower left edge has a locking tab which must clear the grid frame. Push left and up on the lower edge of the deflector. The right edge then readily comes off the lower flange of the cutter grid above.

Wash the deflectors and distributors with a mild detergent solution, rinse with clean water and sanitize with the sanitizer solution. If heavy scale exists the components may be soaked in cleaning solution to remove the scale.

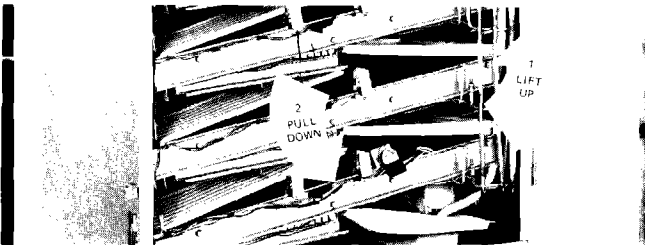

15. Remove the lower water distributors. Lift up on the right side and pull the left edge off of the cutter grid. The plastic distributor may have to be flexed slightly to get it off the grid flange.

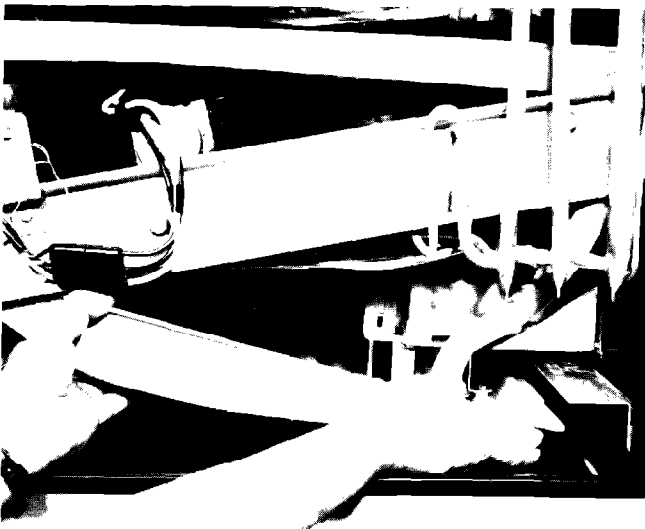

16. Remove the water reservoir pan. Remove the syphon

hose connected to the bottom of the pan. The plastic pan should then be moved to the left until the right edge can be dropped off the mounting flange. During removal the pan may have to be flexed slightly.

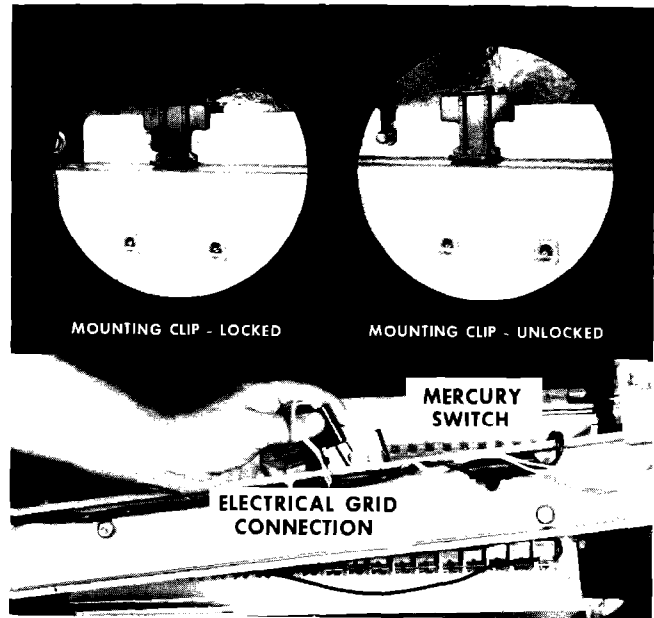

17. Remove each cutter grid. Unplug the electrical connection and remove the grid switch. Grids are held in position on four studs. Sliding clips free the grids from the studs on the left end and the other end of the grid slides off the studs nearest the freezing plate. The entire grid can be placed in cleaning solution (see item 1). Allow the grid to soak and use a toothbrush to remove scale and mineral deposits on connecting pins and grid wires.
18. Wash the ice maker interior with a mild solution of detergent and rinse with fresh water. Then wipe the ice maker interior with the sanitizer solution (see item 1).
19. Reinstall grids, mercury switch, deflectors and distributors.
- NOTE:** Mercury switches are to be positioned as indicated on the sketch located on the support rail. Incorrect position will result in malfunction of the machine.
20. Wash the interior of the bin with a mild solution of detergent, and rinse with fresh water. Then wipe the bin interior with sanitizing solution.
21. Place the service switch to the "normal on" or "timed on" position to resume the ice making cycle.

WINTER SHUT DOWN

If the ice cube maker is to be shut off for several months, remove all ice from the bin and then Clean & Sanitize the ice maker.

Water inlet and drain lines must be blown out if the unit will be subjected to freezing temperatures during shut down. Failure to do so may cause the water inlet or drain line to freeze and rupture. Disconnect electricity to the machine and leave the door cracked open to prevent any odor from developing.

CHANGING CUBE THICKNESS

Turn Clockwise To
Increase Thickness

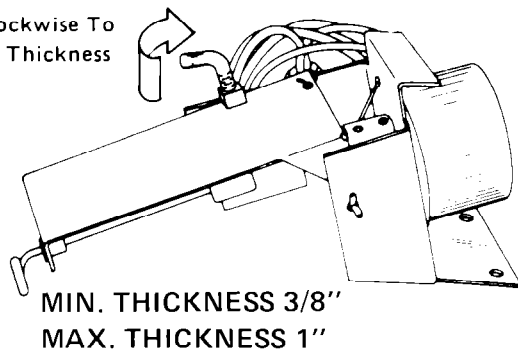

Thickness of the ice can be varied by rotation of the inverted "L" shaped adjusting screw which is located on the thickness control. The thickness control is mounted on the lower freezing plate. One complete rotation of the adjusting screw varies the thickness approximately 1/16". To increase thickness turn the screw in a clockwise direction. Maximum production of ice in pounds will be obtained with the control set to produce ice approximately 1/2" thick.

FILTERING & TREATING WATER

In some areas it may be beneficial to filter or treat the water being supplied to the ice machine to reduce water system maintenance (see Cleaning & Sanitizing the Ice Making System) and to produce the best type of ice.

For information on filtering and treating the water see your WHIRLPOOL commercial ice maker dealer.

OILING

All components of the ice maker are lubricated at the factory and should not require any additional oiling for the normal life of the machine.

GENERAL CARE & CLEANING

Periodic inspection and cleaning is necessary to keep your ice cube maker operating at peak efficiency and to assure a sanitary ice producing mechanism. Your WHIRLPOOL dealer is well qualified to perform this service for you.

CLEANING EXTERIOR SURFACES

Enamel finishes may be cleaned simply by wiping with a damp cloth. Regular use of a good household appliance cleaner and wax is recommended for protecting the finish.

Stainless steel cabinets require the use of a stainless steel cleaner. Carbonated water may be used as a cleaner if a regular stainless steel cleaner is not available.

CLEANING THE CONDENSER

Water Cooled Models

Over a prolonged period of time scale will form on the inside walls of the water condenser which must be removed. When scale forms the ice maker becomes less efficient and requires larger amounts of water for cooling. The scale is cleaned from the inside of the condenser walls with chemicals. It is recommended that the scale removal should be performed by your WHIRLPOOL ice maker dealer.

Air Cooled Models

Adequate air must be allowed to flow through the finned coils of the remote condenser. A dirty or clogged condenser prevents proper air flow resulting in reduced capacity of the ice machine and subjects the components of the unit to higher than normal operating temperatures.

The condenser coil should be inspected approximately once a month and cleaned when necessary. Use a vacuum cleaner and stiff brush to remove the accumulation of lint and dirt.

CLEANING & SANITIZING THE ICE MAKING SYSTEM

Impurities are rejected from the circulating water that freezes into ice. These impurities collect on the freezing mechanism and in the water system and form a hard scaly deposit. Generally this scale prevents a rapid release of the ice slab during the harvest cycle and may cause the warning light to start blinking and glow brighter. The water and ice making system, therefore, should be periodically cleaned and sanitized. The frequency of cleaning will depend on local water conditions and how rapidly scale accumulates.

Cleaning and sanitizing is not too difficult. Having a qualified service representative clean the system the first time should make subsequent cleaning easier to perform if the operator wishes to take over this portion of the ice machine maintenance.

Follow this procedure to assure that the ice machine is clean and sanitary:

1. Cleaning and sanitizing solutions:

Both cleaning and sanitizing solutions are required. Prepare as follows:

Cleaning Solution — Mix a solution of powdered citric acid and hot water (see cleaning label on inside of top front panel for quantity to be used). Citric acid is available in most drug stores. Hot water should be used if possible as the citric acid will go into solution quicker and the cleaning itself is accomplished in less time.

Commercial ice machine cleaners are also available in liquid form and should be mixed according to instructions on the label. These ice machine cleaners are available through commercial refrigeration supply houses.

Sanitizer Solution —

Common laundry bleach mixed at a ratio of 1 oz. to a gallon of water will make an excellent sanitizing solution.

2. Set service switch to "off" position.

3. Remove all ice from the storage bin.

IF THE MACHINE DOES NOT PRODUCE ICE

Check the following before calling a service man:

- A. Unit does not run:
1. Make sure service switch is positioned to "normal on" or "timed on".
 2. If service switch is in "timed on" position then control timer must be in the timed setting which allows the machine to operate.
 3. Check fuses in power supply to ice maker head and remote refrigeration unit.

NOTE: *If the light on control panel is lit, it indicates power supply is okay to ice making section. Separate fuses must be checked for power to remote refrigeration section. Fuses inside control panel are for low voltage circuits only.*

B. Unit runs but produces no ice:

1. Check all mercury switches *positioned over water trough*. Arms must be vertical. If switch arms are not vertical, check for bind. Check position of switch capsule in bracket against sketch on support rail.

2. Push service switch to "off" position for one minute and then reset to "normal on" position.

3. Check fuses in electrical control panel. These fuses control low voltage current to cutter grids, relays and ice thickness control.

C. Unit runs but produces very little ice:

1. Operation of remote condensing unit in extremely high temperatures (normal for ice production to be low).
2. Lint or dirt blocking proper air flow through finned condenser of remote condensing unit (check and clean).
3. Check for objects around remote condensing unit which would obstruct normal air flow.

D. Light on control panel blinks or flashes:

1. Whenever the light is blinking or flashing, it is an indication of an abnormally long harvest cycle. Long harvest cycles are generally caused by ice slabs not releasing properly and may indicate the machine needs to be cleaned.
2. Call a qualified serviceman to check the machine if the above suggestions do not remedy the problem.

Warranty

Whirlpool Corporation warrants to the original purchaser of a WHIRLPOOL Commercial Automatic Ice Maker (herein called "Appliance") that it will, free of charge, repair or exchange, at its option, the following parts returned to Whirlpool by a Whirlpool Authorized Parts Distributor, within the periods specified below and found by Whirlpool to be defective in material or workmanship: (a) for a period of one year after purchase, all Whirlpool approved or FSP parts comprising the Appliance; and (b) for a period of four years following that one year period, the Whirlpool approved or FSP motor compressor in the Appliance.

Whirlpool shall have no responsibility for the labor, shipping costs and other charges incurred through service calls, removal and replacement of defective parts in the Appliance.

This Warranty is not transferable by the purchaser and shall be voided when any part other than a Whirlpool approved or FSP part is incorporated in the Appliance; if alterations not approved by Whirlpool are made in the Appliance; if the serial number plate is altered or removed; or, if the repair or exchange of an in-warranty part is made by other than a service organization authorized by Whirlpool as its dealer. Further, this Warranty does not apply if an Appliance has been subjected to accident, misuse, damage caused by flood, fire or act of God or has been used on circuits, voltages or frequencies other than indicated on the serial number plate of the Appliance.

Whirlpool Corporation's warranty obligations are limited to those set forth herein and no other obligations, expressed or implied, are assumed by Whirlpool Corporation.

WHIRLPOOL CORPORATION, BENTON HARBOR, MICHIGAN



Benton Harbor, Michigan. Manufacturer of Automatic Washers, Wringer Washers, Clothes Dryers, Freezers, Refrigerators, Refrigerator-Freezers, Ice Makers, Dishwashers, Built-In Ovens and Surface Units, Ranges, Food Waste Disposers, Central Vacuum Systems, Dehumidifiers, Air Conditioners.

Free Manuals Download Website

<http://myh66.com>

<http://usermanuals.us>

<http://www.somanuals.com>

<http://www.4manuals.cc>

<http://www.manual-lib.com>

<http://www.404manual.com>

<http://www.luxmanual.com>

<http://aubethermostatmanual.com>

Golf course search by state

<http://golfingnear.com>

Email search by domain

<http://emailbydomain.com>

Auto manuals search

<http://auto.somanuals.com>

TV manuals search

<http://tv.somanuals.com>