

AKZM 8790

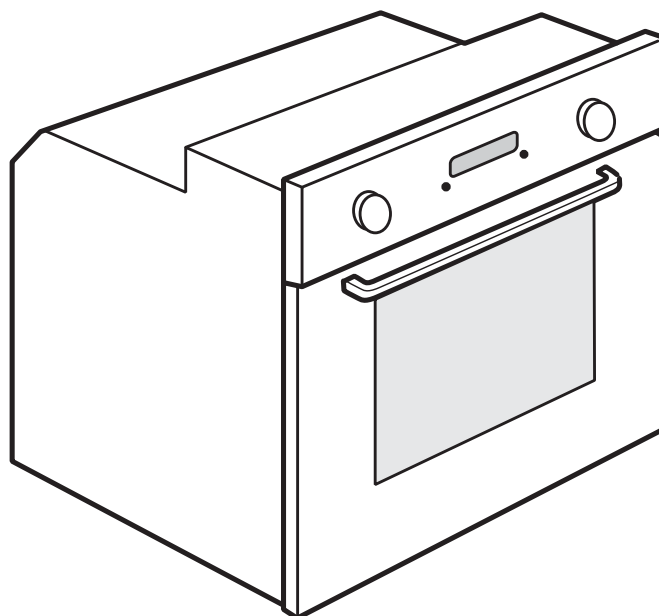

EN

User and maintenance manual

FR

Manuel d'utilisation et d'entretien

NL

Handleiding voor gebruik en onderhoud



IMPORTANT SAFETY INSTRUCTIONS

YOUR SAFETY AND THAT OF OTHERS IS PARAMOUNT

This manual and the appliance itself provide important safety warnings, to be read and observed at all times.



This is the danger symbol, pertaining to safety, which alerts users to potential risks to themselves and others. All safety warnings are preceded by the danger symbol and the following terms:



DANGER

Indicates a hazardous situation which, if not avoided, will cause serious injury.



WARNING

Indicates a hazardous situation which, if not avoided, could cause serious injury.

All safety warnings give specific details of the potential risk present and indicate how to reduce risk of injury, damage and electric shock resulting from improper use of the appliance. Carefully observe the following instructions:

- The appliance must be disconnected from the power supply before carrying out any installation work.
- Installation and maintenance must be carried out by a qualified technician, in compliance with the manufacturer's instructions and local safety regulations. Do not repair or replace any part of the appliance unless specifically stated in the user manual.
- Power cable replacement must be carried out by a qualified electrician. Contact an authorized service centre.
- Regulations require that the appliance is earthed.
- The power cable must be long enough for connecting the appliance, once fitted in its housing, to the main power supply.
- For installation to comply with current safety regulations, an all-pole disconnect switch with minimum contact gap of 3 mm must be utilized.
- Do not use multiple plug adaptors if the oven is fitted with a plug.
- Do not use extension leads.
- Do not pull the power supply cable.
- The electrical components must not be accessible to the user after installation.
- If the surface of the induction plate is cracked, do not use it and switch off the appliance to avoid the possibility of electric shock (only for models with induction function).

- Do not touch the appliance with any wet part of the body and do not operate it when barefoot.
- This appliance is designed solely for use as a domestic appliance for cooking food. No other type of use is permitted (e.g.: heating rooms). The Manufacturer declines all responsibility for inappropriate use or incorrect setting of the controls.
- This appliance can be used by children from 8 years and above and persons with reduced physical, sensory or mental capabilities or lack of experience and knowledge if they have been given supervision or instruction concerning use of the appliance in a safe way and understand hazards involved. Children shall not play with the appliance. Cleaning and user maintenance shall not be made by children without supervision.
- The accessible parts of the appliance may become very hot during use. Young children should be kept away from the appliance and supervised to ensure that they do not play with it.
- The appliance and its accessible parts become hot during use. Care should be taken to avoid touching heating elements. Children less than 8 years old shall be kept away, unless continuously supervised.
- During and after use, do not touch the heating elements or interior surfaces of the appliance - risk of burns. Do not allow the appliance to come into contact with cloths or other flammable materials until all the components have cooled sufficiently.
- At the end of cooking, exercise caution when opening the appliance door, letting the hot air or steam exit gradually before accessing the oven. When the appliance door is shut, hot air is vented from the aperture above the control panel. Do not obstruct the vent apertures.
- Use oven gloves to remove pans and accessories, taking care not to touch the heating elements.
- Do not place flammable materials in or near the appliance: a fire may break out if the appliance is inadvertently switched on.
- Do not heat or cook sealed jars or containers in the appliance. The pressure that builds up inside might cause the jar to explode, damaging the appliance.
- Do not use containers made of synthetic materials.

- Overheated oils and fats catch fire easily. Always remain vigilant when cooking foods rich in fat and oil.
- Never leave the appliance unattended during food drying.
- If alcoholic beverages are used when cooking foods (e.g. rum, cognac, wine), remember that alcohol evaporates at high temperatures. As a result, there is a risk that vapours released by the alcohol may catch fire upon coming into contact with the electrical heating element.
- Never use steam cleaning equipment.
- Do not touch the oven during the pyrolysis cycle. Keep children away from the oven during the pyrolysis cycle. Excess spillage must be removed from the oven cavity before cleaning cycle (only for ovens with Pyrolysis function).
- Only use the temperature probe recommended for this oven.
- Do not use harsh abrasive cleaners or sharp metal scrapers to clean the oven door glass since they can scratch the surface, which may result in shattering of the glass.
- Ensure that the appliance is switched off before replacing the lamp to avoid the possibility of electric shock.
- Do not use aluminium foil to cover food in the cooking vessel (only for ovens with cooking vessel supplied).
- Use protective gloves to perform all unpacking and installation operations.

Scrapping of household appliances

- This appliance is manufactured with recyclable or reusable materials. Dispose of it in accordance with local waste disposal regulations. Before scrapping, cut off the power supply cable.
- For further information on the treatment, recovery and recycling of household electrical appliances, contact your competent local authority, the collection service for household waste or the store where you purchased the appliance.

INSTALLATION

After unpacking the oven, make sure that it has not been damaged during transport and that the oven door closes properly. In the event of problems, contact the dealer or your nearest After-sales Service. To prevent any damage, only remove the oven from its polystyrene foam base at the time of installation.

To safely move the oven, use the handle provided in the accessories pack.

1. Insert the handle securely into the lateral holes (Fig. 1)
2. Lift the handle up as shown in Fig. 2

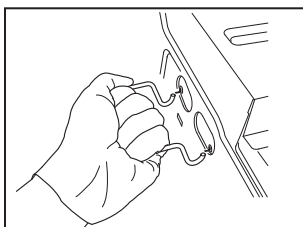

Fig. 1

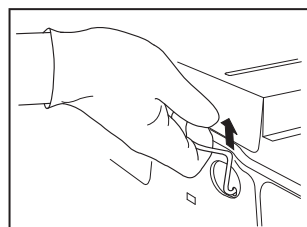

Fig. 2

PREPARING THE HOUSING UNIT

- Kitchen units in contact with the oven must be heat resistant (min 90°C).
- Carry out all cabinet cutting work before fitting the oven in the housing and carefully remove all wood chips and sawdust.
- After installation, the bottom of the oven must no longer be accessible.
- For correct appliance operation, do not obstruct the minimum gap between the worktop and the upper edge of the oven.

ELECTRICAL CONNECTION (only in some models)

Make sure the power voltage specified on the appliance dataplate is the same as the mains voltage. The dataplate is on the front edge of the oven (visible when the door is open).

- Power cable replacement (type H05 RR-F 3 x 1.5 mm²) must be carried out by a qualified electrician. Contact an authorized service centre.
- The oven is programmed to operate with power absorption above 2.5 kW (indicated by "HIGH" in the settings) which is compatible with a domestic power supply above 3kW. If the household has a lower power supply, the setting must be lowered ("LOW" in the settings). The table below details the recommended electrical power settings for the various countries.

Country	Setting
Germany	High
Spain	Low
Finland	High
France	High
Italy	Low
Holland	High
Norway	High
Sweden	High
UK	Low
Belgium	High

GENERAL RECOMMENDATIONS

Before use:

- Remove protective cardboard pieces, protective film and adhesive labels from accessories, induction plate and cooking vessel.
- Remove the accessories from the oven. Position the induction plate at the third level and plug it in.
- Place the cooking vessel on the induction plate and fill it in with 200g of water.
- Select the Top Finishing function and run the oven for approximately one hour to eliminate the smell and fumes from the insulating materials and protective grease.

During use:

- Do not place heavy objects on the door as they could damage it.
- Do not cling to the door or hang anything from the handle.
- Do not cover the inside of the oven with aluminium foil.
- Never pour water into the inside of a hot oven; this could damage the enamel coating.
- Never drag pots or pans across the bottom of the oven as this could damage the enamel coating.
- Make sure that the electrical cables of other appliances do not touch hot parts of the oven or become trapped in the door.
- Do not expose the oven to atmospheric agents.
- Never pour water on the induction plate when inserted into the oven or when it is hot; this could damage the glass or the enamel coating.
- Insert and remove the induction plate carefully in order to avoid accidental damage to the glass and/or electrical plug.
- Before using the oven in standard mode (without induction), completely remove the induction plate from the oven. Leaving the induction plate in the oven could damage it.

After Use:

- Allow the induction plate to cool down before removal if cleaning is required. When the induction plate is removed from the oven, ensure the supplied socket cover is used to prevent dirt entering the electrical socket (Fig. 1).

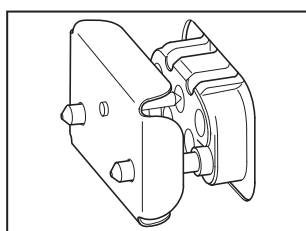



Fig. 1

SAFEGUARDING THE ENVIRONMENT

Disposal of packing material

The packing material is 100% recyclable and is marked with the recycle symbol (♻️). The various parts of the packing must therefore be disposed of responsibly and in full compliance with local authority regulations governing waste disposal.

Scrapping the product

- This appliance is marked in compliance with European Directive 2002/96/EC, Waste Electrical and Electronic Equipment (WEEE).
- By ensuring this product is disposed of correctly, you will help prevent potential negative consequences for the environment and human health, which could otherwise be caused by inappropriate waste handling of this product.
- The symbol  on the product or on the accompanying documentation indicates that it should not be treated as domestic waste but must be taken to an appropriate collection centre for the recycling of electrical and electronic equipment.

Energy saving

- Only pre-heat the oven if specified in the cooking table or your recipe.
- Use dark lacquered or enamelled baking moulds as they absorb heat far better.
- Switch the oven off 10/15 minutes before the set cooking time. Food requiring prolonged cooking will continue to cook even once the oven is switched off.

DECLARATION OF CONFORMITY

- This oven, which is intended to come into contact with foodstuffs, complies with European Regulation (CE) n.1935/2004 and has been designed, manufactured and sold in conformity with the safety requirements of the "Low Voltage" directive 2006/95/CE (which replaces 73/23/CEE and subsequent amendments), the protection requirements of "EMC" 2004/108/CE.

TROUBLESHOOTING GUIDE

The oven does not work:

- Check for the presence of mains electrical power and if the oven is connected to the electrical supply.
- Turn off the oven and restart it to see if the fault persists.

The electronic programmer does not work:

- If the display shows the letter "F" followed by a number, contact your nearest After-sales Service. Specify in this case the number that follows the letter "F".

The induction plate does not work:

- The induction plate must be used on the third shelf position only; ensure it is correctly positioned and fully connected.
- Turn the oven off and then on again. Check if the fault persists.

AFTER-SALES SERVICE

Before calling the After-Sales Service:

1. See if you can solve the problem yourself with the help of the suggestions given in the "Troubleshooting guide".
2. Switch the appliance off and back on again to see if the fault persists.

If after the above checks the fault still occurs, get in touch with the nearest After-sales Service.

Always specify:

- a brief description of the fault;
- the type and exact model of the oven;
- the service number (number after the word Service on the rating plate), located on the right hand edge of the oven cavity (visible when the oven door is open). The service number is also indicated on the guarantee booklet;
- your full address;
- your telephone number.

SERVICE 0000 000 00000



If any repairs are required, please contact an authorised **After-sales Service** (to guarantee that original spare parts will be used and repairs carried out correctly).

CLEANING

! WARNING

- Never use steam cleaning equipment.
- Only clean the oven when it is cool to the touch.
- Disconnect the appliance from the power supply.

Oven exterior

IMPORTANT: do not use corrosive or abrasive detergents. If any of these products accidentally comes into contact with the appliance, clean immediately with a damp Microfibre cloth.

- Clean the surfaces with a damp Microfibre cloth. If it is very dirty, add a few drops of washing up detergent to the water. Finish off with a dry cloth.

Oven interior

IMPORTANT: do not use abrasive sponges or metallic scrapers or scourers. Over time, these can ruin enamelled surfaces and the oven door glass.

- After every use, allow the oven to cool then clean it preferably while it is still warm in order to remove built-up dirt and stains caused by food residues (e.g. food with a high sugar content).
- Use proprietary oven detergents and follow the manufacturer's instructions to the letter.
- Clean the door glass with a suitable liquid detergent. The oven door can be removed to facilitate cleaning (see MAINTENANCE).
- The top heating element of the grill (see MAINTENANCE) can be lowered (some models only) to clean the roof of the oven.

N.B.: during prolonged cooking of foods with a high water content (e.g. pizza, vegetables, etc.) condensation may form on the inside of the door and around the seal. When the oven is cold, dry the inside of the door with a cloth or sponge.

Accessories:

- Soak the accessories in water with washing up detergent immediately after use, handling them with oven gloves if still hot.
- Food residues can be easily removed using a brush or sponge.

Induction Plate:

- When cool to the touch, use a sponge and suitable liquid detergent for ovens or hobs. Do not clean the induction plate in a dishwasher.

Internal Electrical Socket:

- Remove the metallic plug cover; use a humidified sponge to clean the plug. Do not use metallic and/or sharp tools.

Cooking Vessel:

- Suitable for dishwashing. Alternatively, use soft sponge and suitable liquid detergent.

Cleaning the rear wall and catalytic side panels of the oven (if present):

IMPORTANT: do not use corrosive or abrasive detergents, coarse brushes, pot scourers or oven sprays which could damage the catalytic surface and ruin its self-cleaning properties.

- Operate the oven empty with the fan-assisted function at 200°C for about one hour.
- Next, leave the appliance to cool down before removing any food residue with a sponge.

MAINTENANCE

! WARNING

- Use protective gloves.
- Ensure the oven is cold before carrying out the following operations.
- Disconnect the appliance from the power supply.

REMOVING THE DOOR

To remove the door:

1. Open the door fully.
2. Lift the catches and push them forwards as far as they will go (fig. 1).
3. Close the door as far as it will go (A), lift it up (B) and turn it (C) until it is released (D) (fig. 2).

To refit the door:

1. Insert the hinges in their seats.
2. Open the door fully.
3. Lower the two catches.
4. Close the door.

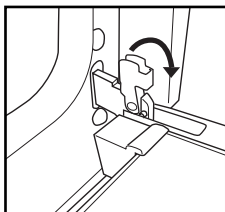

Fig. 1

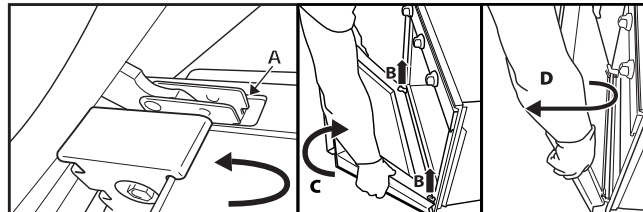

Fig. 2

REMOVING THE SIDE GRILLES

The accessory-holder grilles are equipped with two fixing screws (fig. 1) for optimum stability.

1. Remove the screws and fixing plates on the right and left with the aid of a coin or tool.
2. To remove the grilles, lift them up (1) and turn them (2) as shown in fig. 3.

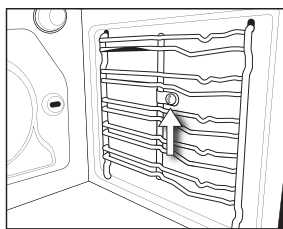

Fig. 1

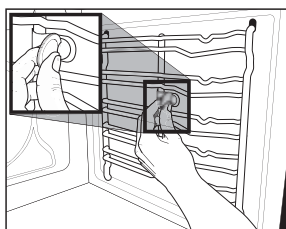

Fig. 2

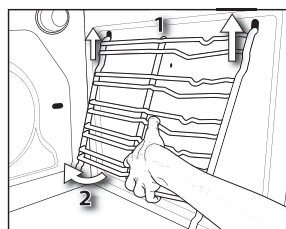

Fig. 3

MOVING THE TOP HEATING ELEMENT (SOME MODELS ONLY)

1. Remove the side accessory holder grilles (Fig. 3).
2. Pull the heating element out a little (Fig. 4) and lower it (Fig. 5).
3. To reposition the heating element, lift it up, pulling it slightly towards you, making sure it comes to rest on the lateral supports.

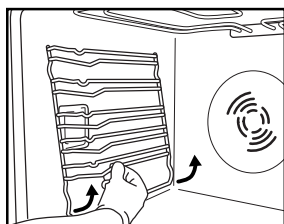

Fig. 4

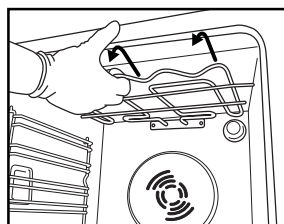

Fig. 5

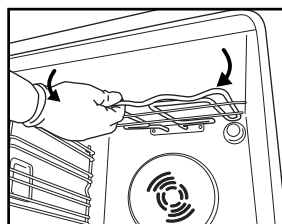

Fig. 6

REPLACING THE OVEN LAMP

To replace the rear lamp (if present):

1. Disconnect the oven from the power supply.
2. Unscrew the lamp cover (Fig. 6), replace the lamp (see note for lamp type) and screw the lamp cover back on.
3. Reconnect the oven to the power supply.

To replace the side lamp (if present):

1. Disconnect the oven from the power supply.
2. Remove the side accessory holder grilles, if present (Fig. 3).
3. Use a screwdriver to prise off the lamp cover (Fig. 7).
4. Replace the lamp (see note for lamp type) (Fig. 8).
5. Reposition the lamp cover, pushing it on firmly until it snaps into place (Fig. 9).
6. Refit the side accessory holder grilles.
7. Reconnect the oven to the power supply.

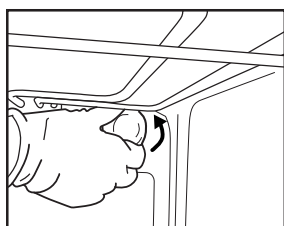

Fig. 7

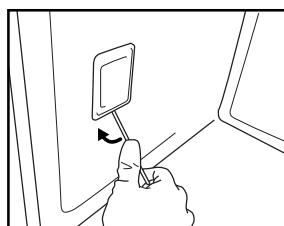

Fig. 8

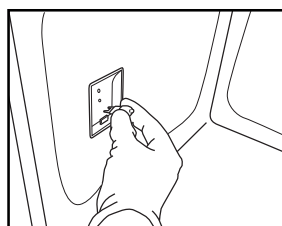

Fig. 9

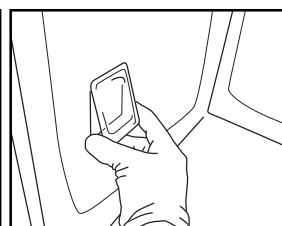

Fig. 10

N.B.:

- Only use 25-40W/230V type E-14, T300°C incandescent lamps, or 20-40W/230 V type G9, T300°C halogen lamps.
- The lamp used in the appliance is specifically designed for electrical appliances and is not suitable for household room illumination (Commission Regulation (EC) No 244/2009).
- Lamps are available from our After-sales Service.

IMPORTANT:

- **If using halogen lamps, do not handle with bare hands since fingerprints can damage them.**
- **Do not use the oven until the lamp cover has been repositioned.**

INSTRUCTIONS FOR OVEN USE

FOR ELECTRICAL CONNECTION, SEE THE PARAGRAPH ON INSTALLATION

The induction oven is equipped with an electrical socket on the rear wall of the oven to supply power to the heating element inside the induction plate when plugged in.

The induction plate is designed to work together with the induction cooking vessel supplied with the oven. Improved cooking performances and energy consumption can be achieved by using the cooking vessel and induction plate.

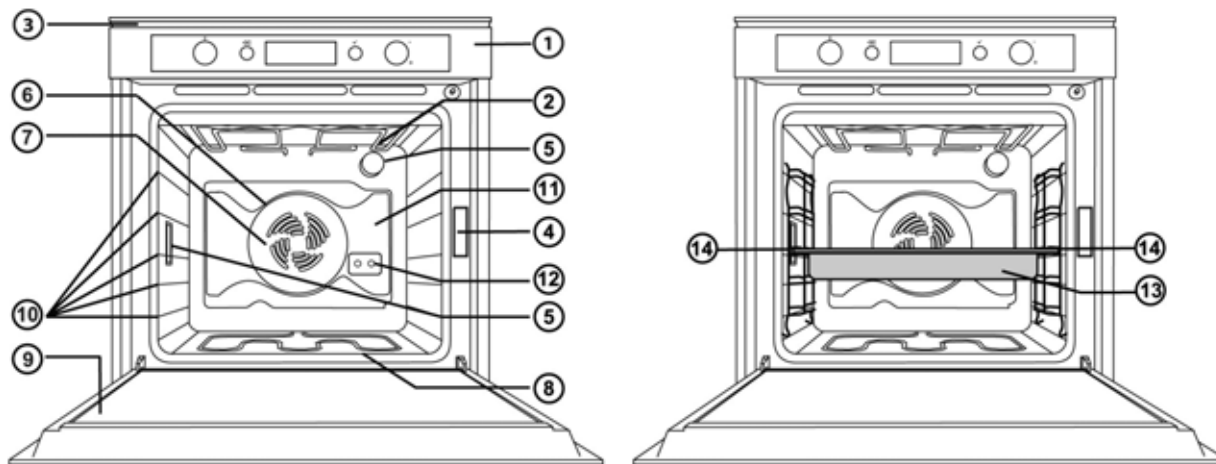

1. Control panel
2. Upper heating element/grill
3. Cooling fan (not visible)
4. Dataplate (not to be removed)
5. Lamps
6. Circular heating element (not visible)
7. Fan
8. Lower heating element (not visible)
9. Door
10. Position of shelves (the number of shelves is indicated on the front of the oven)
11. Rear wall
12. Electrical socket (inside oven)
13. Induction Plate
14. Induction Plate position

N.B.:

- During cooking, the cooling fan may switch on at intervals in order to minimise energy consumption.
- At the end of cooking, after the oven has been switched off, the cooling fan may continue to run for a while.
- When the oven door is opened during cooking, the heating elements switch off.

ACCESSORIES SUPPLIED

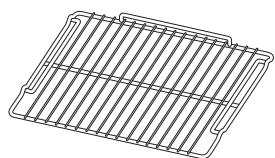

Fig. A

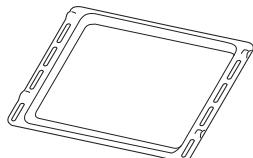

Fig. B

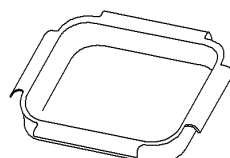

Fig. C

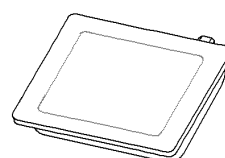

Fig. D

- A. WIRE SHELF (2):** the wire shelf can be used to grill food or as a support for pans, cake tins and other ovenproof cooking receptacles.
- B. DRIP TRAY (1):** the drip tray is designed to be positioned under the wire shelf in order to collect fat or as an oven tray for cooking meat, fish, vegetables, focaccia, etc.
- C. COOKING VESSEL (1):** the cooking vessel is designed to be used with the induction plate and should be placed according to the position markings on the induction plate glass.
- D. INDUCTION PLATE (1):** to be used in induction mode only by placing it on the third shelf position and ensuring the electrical plug is fully inserted (refer to "Inserting wire shelves and other accessories in the oven").

ACCESSORIES NOT SUPPLIED

Other accessories can be purchased separately from the After-sales Service.

INSERTING WIRE SHELVES AND OTHER ACCESSORIES IN THE OVEN

WIRE SHELVES AND OTHER ACCESSORIES:

The wire shelf and other accessories are provided with a locking mechanism to prevent their accidental removal.

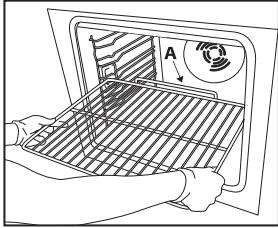

Fig. 1

1. Insert the wire shelf horizontally, with the raised part "A" upwards (Fig. 1).
2. Angle the wire shelf when it reaches the locking position "B" (Fig. 2).

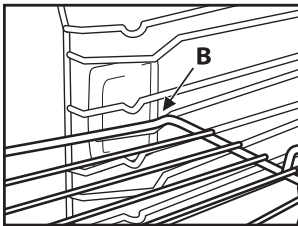

Fig. 2

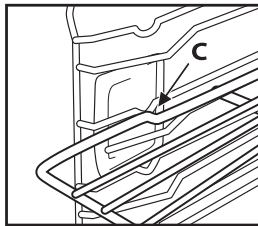

Fig. 3

3. Return the wire shelf to the horizontal position and push it in fully to "C" (Fig. 3).
4. To remove the wire shelf proceed in reverse order.

The other accessories, like the drip tray and baking tray, are inserted in exactly the same way. The protrusion on the flat surface enables the accessories to lock in place.

INDUCTION PLATE:

The Induction plate must be inserted at the third shelf position to allow the electrical plug to engage.

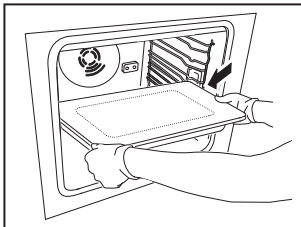

Fig. 1

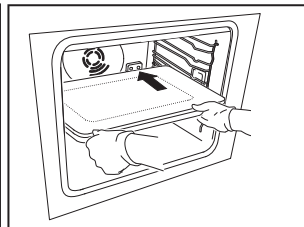

Fig. 2

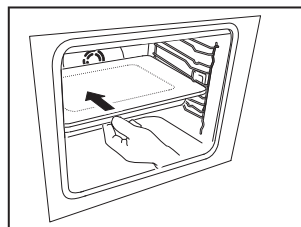

Fig. 3

1. Use both hands to properly place the induction plate on the third shelf position (Fig. 1).
2. Use both hands to push the induction plate up to the electrical plug (Fig. 2).
3. Ensure the plug is fully engaged by firmly pushing the induction tray (Fig. 3).

COOKING VESSEL:

Place the cooking vessel on the induction plate, ensuring that the bottom of the vessel lays within the rectangular markings on induction plate glass.

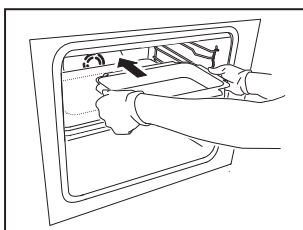

Fig. 4

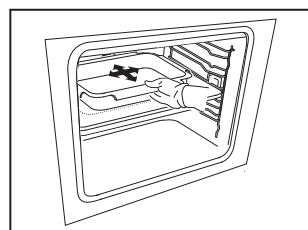

Fig. 5

1. Use both hands to place the cooking vessel on the induction plate (Fig. 4).
2. Place the cooking vessel at the centre of the markings on the glass (Fig. 5).

REMOVAL OF THE COOKING VESSEL AND INDUCTION PLATE

REMOVING THE COOKING VESSEL:

IMPORTANT: The induction cooking vessel can become extremely hot. Always use oven gloves to touch and move it.

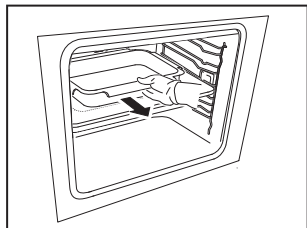

Fig. 1

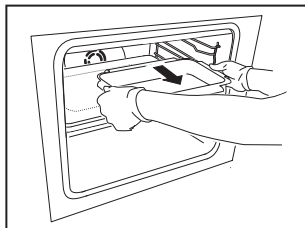

Fig. 2

1. Using both hands, grasp the front handle and partially remove the cooking vessel (Fig. 1).
2. Then use the lateral handles to better grasp and fully remove the cooking vessel (Fig. 2).

REMOVING THE INDUCTION PLATE:

IMPORTANT: To ensure a good electrical connection, the induction plate will be securely inserted and will require some slight additional force to be disengaged. Do not remove the induction plate when the cooking vessel or any other accessory is present.

Always use oven gloves when induction plate and/or oven are hot.

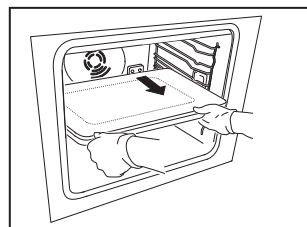

Fig. 3

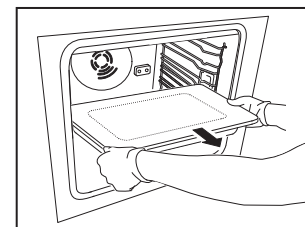
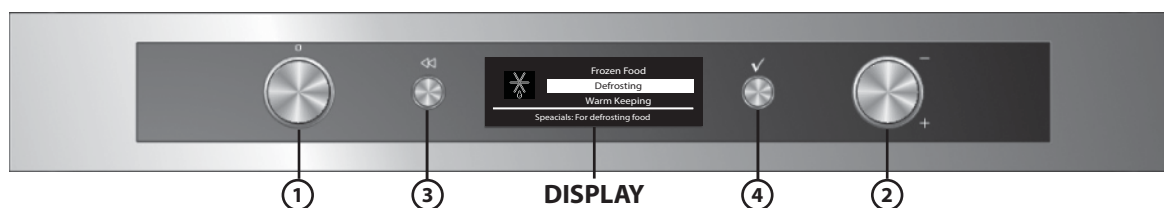

Fig. 4

1. With both hands, grasp the induction plate and remove it. Some slight force will be needed to disengage the plate from the socket (Fig. 3).
2. With both hands, remove the induction plate and store it away, carefully avoiding impacts that could damage the glass or electrical plug (Fig. 4).

CONTROL PANEL DESCRIPTION

ELECTRONIC PROGRAMMER



1. **FUNCTION SELECTOR KNOB:** On/off and function selector knob
 2. **BROWSE KNOB:** for browsing the menu and adjusting pre-set values
- N.B.: the two knobs are retractable. Press the knobs in the middle and they pop up.**
3. **BUTTON** ⏪ : to return to the previous screen
 4. **BUTTON** ✓ : to select and confirm settings

LIST OF FUNCTIONS

Turn the "Functions" knob to any position and the oven switches on. The display will show the following indication:

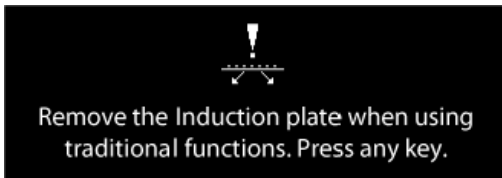

Press any key to skip the message and the display will show the functions or the associated submenus.

NOTE: The induction first alert can be disabled/enabled through the Settings Menu. If the induction plate is already properly engaged, when oven is switch on, the induction first alert will not be shown.

The submenus are available and selectable by turning the knob to the functions INDUCTION, GRILL, SPECIALS, SETTINGS and RECIPES.

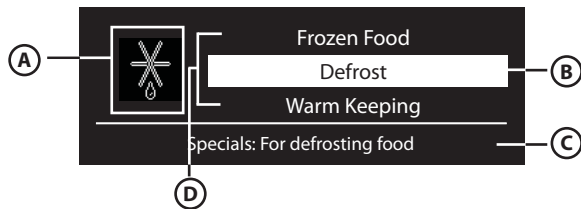

- A. Symbol for highlighted function
- B. Highlighted function can be selected by pressing ✓
- C. Description of highlighted function
- D. Other available and selectable functions.

DETAILS OF FUNCTION

After selection of the desired function, the display will show further options and related details.

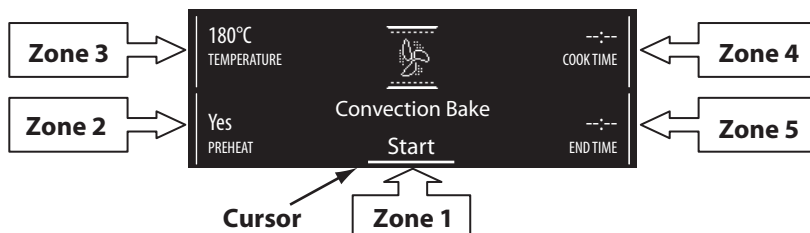

To move between the different areas, turn the "Browse" knob: the cursor moves to the adjustable values, following the order described above. Press button ✓ to select the value, change it by turning the "Browse" knob and confirm with button ✓.

NOTE: In induction mode only Zone 4 and Zone 5 can be adjusted.

USING THE APPLIANCE FOR THE FIRST TIME – LANGUAGE SELECTION AND SETTING THE TIME

For correct use of the oven, when it is switched on for the first time you will have to select the desired language and set the correct time.

Proceed as follows:

1. Turn the "Functions" knob to any position: the display will show the list of the first three available languages.
2. Turn the "Browse" knob to scroll the list.
3. When the desired language is highlighted, press ✓ to select it.
After language selection, the display will flash 12:00.
4. Set the time by turning the "Browse" knob.
5. Confirm your setting by pressing ✓.

SELECTING COOKING FUNCTIONS



1. If the oven is off, turn the "Functions" knob; the display will show the cooking functions or associated submenus.

N.B.: for the list and description of functions, see the specific table at page 16 and at page 17. If the induction plate is already properly engaged or whenever the induction plate is inserted, only Induction Functions and Settings will be accessible through the main menu.

If knob is not set on Induction Functions the display will show the message "Please select the induction mode".

If the induction plate is not engaged into the oven, both standard functions MENU and induction functions MENU will be accessible.

When the induction plate is inserted or removed, a message indicating correct engagement/disengagement will be shown on the display.

2. Within the submenus, browse the various options available by turning the "Browse" knob: the chosen function is highlighted in white in the centre of the screen. To select it, press .
3. the cooking settings are displayed on the screen. If the pre-set values are those desired, turn the "Browse" knob to position the cursor at "Start" and then press ; otherwise, proceed as indicated above to change them.

SETTING THE TEMPERATURE/OUTPUT OF THE GRILL (Standard Functions only)

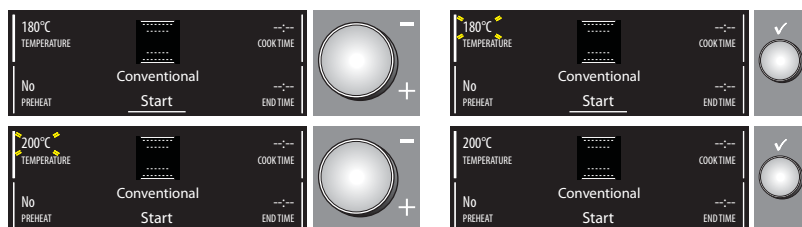

To change the temperature or output of the grill, proceed as follows:

1. Check that the cursor is positioned next to the temperature value (zone 1); press button to select the parameter to be changed: the temperature values flash.
2. Set the desired value by turning the "Browse" knob and press to confirm.
3. Turn the "Browse" knob to position the cursor at "Start" and then press .
4. The display indicates which shelf food should be placed on. Do as instructed and press to start cooking.

The set temperature can also be changed during cooking by following the same procedure.

5. At the end of cooking, the end of cooking message is displayed. At this point the oven can be switched off by turning the "Functions" knob to 0 (zero), or cooking can be prolonged by turning the "Browse" knob clockwise. When switched off, the display shows the cooling bar which indicates the temperature inside the oven.

PREHEATING THE OVEN (Standard Functions only)

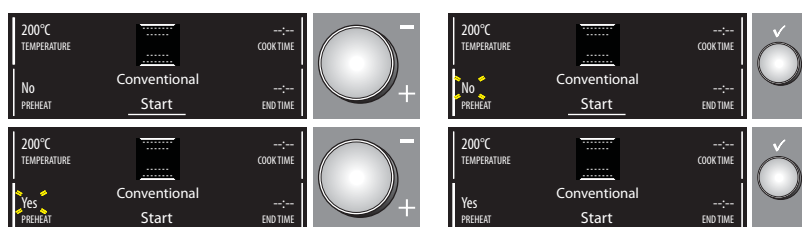

If you wish to preheat the oven before inserting food, change the oven's default selection as follows:

1. Turn the "Browse" knob to position the cursor at preheating.
2. Press button to select the setting: "No" flashes on the display.
3. Change the setting by turning the "Browse" knob: the display shows "Yes".
4. To confirm your choice, press button .

FAST PREHEATING (Standard Functions only)



If you wish to preheat the oven quickly before inserting food, change the oven's default selection as follows:

1. Turn the "Functions" knob to select the fast preheating function.
2. Confirm by pressing \checkmark : the settings are displayed on the screen.
3. If the proposed temperature is that desired, turn the "Browse" knob to position the cursor at "Start" and then press \checkmark . To change the temperature, proceed as described in previous paragraphs. An acoustic signal will sound when the oven has reached the set temperature. At the end of preheating, the oven automatically selects the conventional function \square .
At this point food can be placed in the oven for cooking.
4. If you wish to set a different cooking function, turn the "Functions" knob and select the desired function.

SETTING COOKING TIME

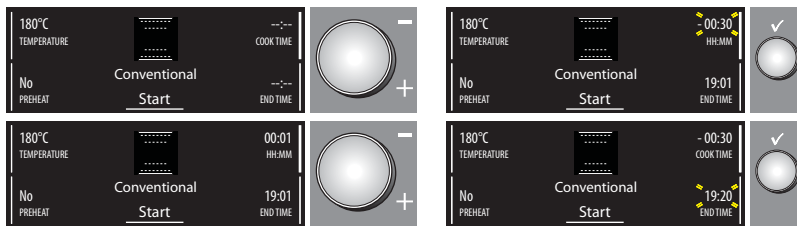

This function can be used to cook food for a set length of time, from a minimum of 1 minute to the maximum time allowed by the selected function, after which the oven switches off automatically.

1. To select the function, turn the "Browse" knob to position the cursor at "cooking duration".
2. Press button \checkmark to select the setting; "00:00" flashes on the display.
3. Change the value by turning the "Browse" knob to display the desired cooking time.
4. Confirm the selected value by pressing button \checkmark .

BROWNING (Standard Functions only)

At the end of cooking, with certain functions, the display indicates the possibility of browning the surface of your dish. This function can only be used when cooking time has been set.

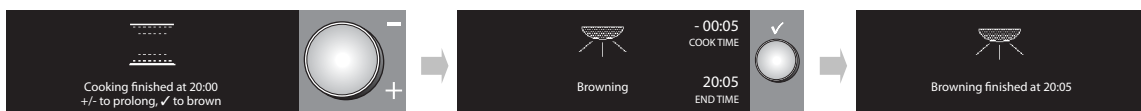

At the end of cooking time, the display shows "+/- to prolong, \checkmark to brown". Press button \checkmark , and the oven starts a 5 minute browning cycle. This function can only be used once after cooking.

SETTING END OF COOKING TIME / DELAYED START

The end of cooking time can be set, delaying the start of cooking by up to a maximum of 23 hours and 59 minutes. This can only be done once cooking time has been set. **This setting is only possible when pre-heating is not required for the selected function.**

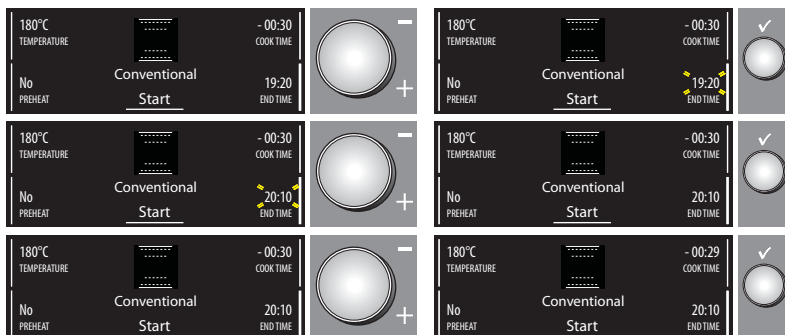

After setting cooking time, the display shows the end of cooking time (for example 19:20). To delay the end of cooking time, and thus also the cooking start time, proceed as follows:

1. Turn the "Browse" knob to position the cursor at the end of cooking time.

- Press button to select the setting: the end of cooking time flashes.
- To delay the end of cooking time, turn the "Browse" knob to set the desired value.
- Confirm the selected value by pressing button .
- Turn the "Browse" knob to position the cursor at START and then press .
- The display indicates which shelf food should be placed on. Do as instructed and press to start cooking. The oven will start cooking after a period of time calculated so as to finish cooking at the set time (for example, in the case of a dish which requires a cooking time of 20 minutes, if the end of cooking time is set to 20:10, the oven will begin cooking at 19:50).

N.B.: During the interval before cooking starts, the oven can in any case be switched on by turning the "Browse" knob to position the cursor at "Start" and then pressing .

At any time, set values (temperature, grill setting, cooking time) can be changed as described in previous paragraphs.

TIMER

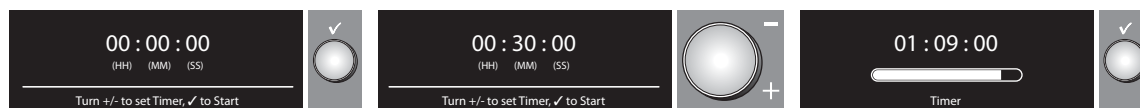

This function can be used only with the oven switched off and is useful, for example, for monitoring the cooking time of pasta. The maximum time which can be set is 1 hour 30 minutes.

- With the oven switched off, press button : the display will show "00:00:00".
- Turn the "Browse" knob to select the desired time.
- Press button to start the countdown. When the set time has elapsed, the display will show "00:00:00" and an acoustic signal will sound. At this point the time can be prolonged, proceeding as described above, or the timer can be deactivated by pressing button (the time of day will be shown on the display).

RECIPES

Thanks to "Sixth sense" technology, the oven offers 30 pre-set recipes with ideal cooking temperatures. Simply follow the recipe as regards ingredients and the method of preparation. Then, proceed as follows:

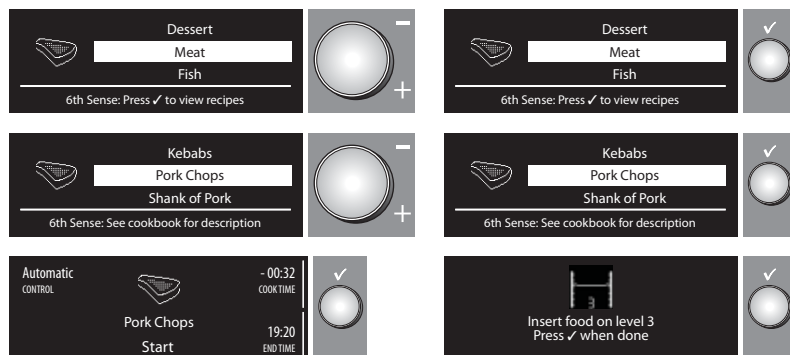

- Select "RECIPES" by turning the "Functions" knob.
- Select the dish to be cooked from the proposed list.
- Confirm the selected dish using button .
- Select the desired recipe by turning the "Browse" knob.
- Confirm by pressing : the display shows the approximate cooking time.
- Place the dish in the oven and turn the "Browse" knob to position the cursor at "Start", then press .
- The display indicates which shelf food should be placed on. Do as instructed and press to start cooking. To delay the start of cooking, see the relevant paragraph.

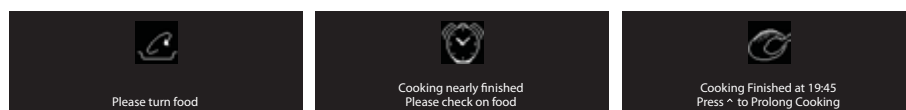

N.B.: Some dishes must be turned or stirred half way through cooking: the oven will emit an acoustic signal and the display will indicate what action is required.

The initial cooking time displayed is merely for guidance: it can be prolonged automatically during cooking.

Shortly before cooking time finishes, the oven prompts you to check that the food is cooked to your satisfaction. If it is not, extra time can then be added manually by turning the "Browse" knob.

INDUCTION FUNCTIONS

Thanks to the Induction Heating technology, the oven offers several cooking functions (see Function Description table) which guarantee high cooking performances together with a very fast cooking process and low energy consumption.





In order to ensure optimum performance, use the induction plate in combination with the supplied stainless steel cooking vessel (see **Inserting Wire Shelves and Other Accessories in the Oven** for information on how to insert both the induction plate and the cooking vessel).

To start the Induction functions etc. navigate the main menu (refer to **Selecting Cooking Functions** or press the induction direct access icon).

To access the induction functions on the user interface, the induction plate must be properly inserted into the oven.

If an induction cooking cycle is required but the induction plate or cooking vessel are not inserted, the appliance will detect the absence of one or both and will advise that they be inserted before proceeding:





1. Turn the function knob to Induction Functions
2. Select the food category to be cooked with the browse knob from the proposed list and confirm using .
3. According to food category, further subcategory and/or food weight may be selected by turning the browse knob and confirm with .
4. Press button  to confirm.
5. Place the food in the oven and press .

6th Sense Induction Functions

Some cooking functions (Roasted Meat, Roasted Poultry and Fish) are 6th sense assisted. Given the weight of food to be prepared, 6th sense technology cooking suggests the cooking time. Cooking time may be adjusted to fit personal preferences and for some meat categories refers to a rare preparation (see Induction Oven cooking tables for more details).



SETTINGS

1. To change some display settings, select "SETTINGS" from the main menu by turning the "Functions" knob.
2. Confirm by pressing : the display shows which settings can be changed (induction first alert, language, volume of acoustic signal, display brightness, time, energy saving function).
3. Select the setting to be changed by turning the "Browse" knob.
4. Press button  to confirm.
5. Follow the instructions of the display to change the settings.
6. Press button ; a message appears on the display confirming your selection.











N.B.: When the oven is switched off, if the ECOMODE (Energy saving) function is selected (ON), the display switches off after a few seconds, showing the clock. To view information on the display and switch the light on again, just press any of the buttons or turn one of the knobs. During a cooking function if the ECOMODE is activated the cavity lamp will be switched off after 1 minute of cooking and reactivated for each user interaction. If, on the other hand, the function is not selected (OFF), after a few minutes the display is merely dimmed.







KEY-LOCK

This function can be used to lock the buttons and knobs on the control panel.

To activate it, press  and  at the same time for at least 3 seconds. If activated, the functions of the buttons are locked and the display shows a message and the symbol . This function can also be activated during cooking. To deactivate it, repeat the above procedure. When the key-lock function is activated, the oven can be switched off by turning the knob to 0 (zero). In this case, however, the previously selected function will have to be set again.

FUNCTION DESCRIPTION TABLE

FUNCTION SELECTOR KNOB		
	OFF	To halt cooking and switch off the oven.
	INDUCTION FUNCTIONS	See INDUCTION FUNCTIONS.
	RECIPES	Selecting 30 different pre-set recipes (see enclosed recipe booklet). The oven automatically sets the optimum cooking temperature, function and time. It is important to follow the instructions given in the recipe book regarding preparation, accessories and which oven shelf to use.
	SETTINGS	Setting the display (language, time, brightness, volume of acoustic signal, energy saving function).
	SPECIALS	See SPECIAL FUNCTIONS.
	CONVECTION BAKE	To cook meat and pies with liquid filling (savoury or sweet) on a single shelf. Use the 3rd shelf. The oven does not have to be preheated.
	FORCED AIR	To cook a variety of food requiring the same cooking temperature on several shelves (maximum three) at the same time (e.g. fish, vegetables, cakes). This function can be used to cook different foods without odours being transferred from one food to another. Use the 3rd shelf to cook on one shelf only, the 1st and 4th to cook on two shelves, and the 1st, 3rd and 5th to cook on three shelves. The oven does not have to be preheated.
	GRILL	To grill steak, kebabs and sausages; to cook vegetables au gratin and toast bread. Place food on the 4th or 5th shelf. When grilling meat, use the drip tray to collect the cooking juices. Position it on the 3rd/4th shelf, adding approx. half a litre of water. The oven does not have to be preheated. During cooking the oven door must remain closed.
	TURBO GRILL	To roast large joints of meat (legs, roast beef, chickens). Position the food on the middle shelves. Use the drip tray to collect the cooking juices. Position it on the 1st/2nd shelf, adding approx. half a litre of water. The oven does not have to be preheated. During cooking the oven door must remain closed. With this function you can also use the turnspit, if provided.
	CONVENTIONAL	To cook any kind of dish on one shelf only. Use the 3rd shelf. To cook pizza, savoury pies and sweets with liquid fillings, use the 1st or 2nd shelf. The oven does not have to be preheated.
	FAST PREHEATING	To preheat the oven rapidly.

SPECIAL		
	DEFROST	To speed up defrosting of food. Place food on the middle shelf. Leave food in its packaging in order to prevent it from drying out on the outside.
	KEEP WARM	For keeping just-cooked food hot and crisp (e.g: meat, fried food or flans). Place food on the middle shelf. The function will not activate if the temperature in the oven is above 65°C.
	RISING	For optimal rising of sweet or savoury dough. To safeguard the quality of proving, the function will not activate if the temperature in the oven is above 40°C. Place the dough on the 2nd shelf. The oven does not have to be preheated.
	CONVENIENCE	Cooking ready meals kept at room temperature or from refrigerated cabinets (biscuits, liquid cake mixtures, muffins, first courses and bakery products). This function gently cooks all food quickly; it can also be used to reheat cooked food. Follow the instructions on the food packaging. The oven does not have to be preheated.
	MAXI COOKING	To cook large joints of meat (above 2.5 kg). Use the 1st or 2nd shelves, depending on the size of the joint. The oven does not have to be preheated. It is advisable to turn the meat over during cooking, to obtain even browning on both sides. It is preferable to baste the meat every now and again so that it does not become too dry.
	FROZEN FOOD	Lasagne
		Pizza
		Strudel
		French Fries
		Bread
	Custom	The temperature can be set from 50 to 250°C to cook other types of product.
	ECO FORCED AIR	For cooking filled roast meats and meat cuts on one level only. This function uses discontinuous, delicate fan assistance, which prevents excessive drying of foods. In this ECO function the light is switched off during cooking and can be temporarily switched on by pressing the confirmation button. It is advisable to use 3rd level. The oven does not have to be preheated.

INDUCTION FUNCTIONS

	FOOD TYPES	Roasted Meat	Roast beef 4 steps: from 0.6 to 2 kg	The function automatically selects the ideal cooking temperature and mode for different weight categories (see oven display). It is possible to roast any type of meat (e.g. beef, veal, pork, ribs, lamb, etc.). The function "top finishing" is optimal to obtain high level of surface browning
			Roast meat 3 steps: from 1 to 4 kg	
			fillet / piece	
		Roasted poultry	Whole 5 steps: from 0.6 to 3 kg	The function automatically selects the ideal cooking temperature and mode for different weight categories (see oven display). It is possible to roast any type of poultry (e.g. chicken, turkey, duck etc.). The function "top finishing" is optimal to obtain high level of surface browning
			fillet / piece	
		Fish	Whole 3 steps: from 0.2 to 1 kg	The function automatically selects the ideal cooking temperature and mode for different weight categories (see oven display). Is possible to cook any type of fish (e.g. swordfish, sea bass, sea bream etc.)
			fillet / piece	
		Vegetables	Roasted Vegetables	This function is ideal for cooking different type of vegetable with the option for roasting or cooking vegetables filled with other ingredients such as meat, cheese, béchamel sauce etc..
			Stuffed Vegetables	
		Cookies/ Muffins	Muffins	This function is ideal for cookies or muffins, from the classic biscuits to small cakes stuffed with marmalade, chocolate or other ingredients. Choose the function "Muffins" when a rising phase is required.
			Cookies	
		Cakes	Sweet Cakes	This function is ideal for cooking sweet or savoury cakes, pies and flans. From the classic fruit tart to many different types of savoury flan including Quiche Lorraine.
			Savoury Pie/Flan	
		Pizza	Thin Pizza	This function is ideal for cooking all types of Pizza.
Thick Pizza				
Traditional Bread			This function is ideal for cooking any type of taste, shape and flavouring of Pizza	
Casserole / Main course			This function is ideal for cooking different preparations based on pasta, with sauce, cream, meat, vegetables (e.g. Lasagna).	
CUSTOM	Low Power		This function is ideal for cooking items that do not fall into a specific food type category. This function is divided into three power levels to allow you to chose between the low, medium and high combination of the grill and tray. It is possible to switch between low, medium and high power levels at any time during cooking.	
	Medium Power			
	High Power			
REHEATING	-		This function is ideal for keeping just-cooked dishes hot and crisp and allows re-heating of previously cooked dishes with a gentle transfer of heat	

	FINISHING	Top Finishing	Low grill	These functions are ideal for finishing any dish that requires a grill or gratin cooking mode. Using three different level of grill, it is possible to control the power or speed of this cooking mode. During top finishing the tray is not functional.	
			Medium grill		
			High grill		
		Base Finishing	Low power		These functions are ideal for finishing any kind of dish that requires only a base source of heat. Using three different power levels of the induction tray, it is possible to control the power and speed of base finishing. During base finishing the grill is not functional.
			Medium power		
			High power		

Recipe with cooking vessel (provided)	Function	Pre-heat	Level tray	Temperature	Range time (min.-max) LOW*		Range time (min.-max) HIGH*	
Lasagna	Casserole / Main	No	3	Automatic	30	45	30	45
Pasta pasticciata/cannelloni		No	3	Automatic	30	45	30	45
Roast beef rare 48° (0.6 - 0.8 Kg)	Roasted –beef	No	3	Automatic	30	35	25	35
Roast beef rare 48° (0.9 - 1.2 Kg)		No	3	Automatic	40	55	30	40
Roast beef rare 48° (1.3 - 1.5 Kg)		No	3	Automatic	40	65	45	55
Roast beef rare 48° (1.6 - 2 Kg)		No	3	Automatic	65	80	55	70
Roast pork / veal (1 - 2 Kg)	Roasted meat – whole	No	3	Automatic	60	80	55	70
Roast pork / veal (2 - 3 Kg)		No	3	Automatic	65	85	60	75
Roast pork / veal (3 - 4 Kg)		No	3	Automatic	70	90	65	80
Pork ribs	Roasted meat – fillet/piece	No	3	Automatic	25	45	25	35
Roast chicken (0.6 - 0.8 Kg)	Roasted poultry – whole	No	3	Automatic	35	45	25	35
Roast chicken (0.9 - 1.2 Kg)		No	3	Automatic	65	80	40	50
Roast chicken (1.3 - 1.5 Kg)		No	3	Automatic	75	95	55	70
Roast chicken (1.6 - 2 Kg)		No	3	Automatic	85	110	65	120
Roast chicken 2 - 3 Kg)		No	3	Automatic	120	155	105	130
Chicken thighs	Roasted poultry – fillet/piece	No	3	Automatic	35	50	30	35
Chicken thighs with potatoes		No	3	Automatic	35	50	30	35
Trout (0.2 - 0.4 Kg)	Fish whole	No	3	Automatic	35	35	15	25
Trout (0.5 - 0.8 Kg)		No	3	Automatic	35	45	25	35
Trout (0.8 - 1.0 Kg)		No	3	Automatic	45	45	35	45

















Recipe with cooking vessel (provided)	Function	Pre-heat	Level tray	Temperature	Range time (min.-max) LOW*		Range time (min.-max) HIGH*	
Cod fish	Fish fillet / piece	No	3	Automatic	20	35	20	30
Roasted potatoes	Vegetables – roasted	No	3	Automatic	35	45	25	35
Mixed vegetables		No	3	Automatic	35	45	25	35
Stuffed zucchini	Vegetables – stuffed	No	3	Automatic	20	30	20	30
Stuffed tomatoes		No	3	Automatic	20	30	20	30
Small cakes	Cookies – muffins	No	3	Automatic	25	35	25	35
Biscuit / Sablè	Cookies	No	3	Automatic	15	25	15	25
Fruit tart	Pastry cakes	No	3	Automatic	30	40	25	35
Quiche Lorraine	Salty cakes	No	3	Automatic	35	45	25	35
Traditional bread	Bread	No	3	Automatic	30	40	30	40
Homestyle pizza	Thick pizza	No	3	Automatic	30	40	25	30
Crisp pizza	Thin pizza	No	3	Automatic	20	25	15	20





















* At the beginning of the cooking cycle, an indicative time is displayed. The cooking time may be modified in order to suit personal preferences and for different kinds of meat/fish. For Roasted meat – Roast Beef the indicated cooking time refers to the time taken to cook the roast beef rare.









Refer to the table to chose proper range time (according to power setting LOW/HIGH). For more information see Electrical Connection paragraph. If Electrical Connection setting is not available, power setting is HIGH by default.

Country	Setting
Germany	High
Spain	Low
Finland	High
France	High
Italy	Low
Holland	High
Norway	High
Sweden	High
UK	Low
Belgium	High

COOKING TABLE















Recipe	Function	Pre-heating	Shelf (from bottom)	Temp. (°C)	Time (min)	Accessories and notes
Leavened cakes		-	2 / 3	160-180	30-90	Cake tin on rack
		-	1-4	160-180	30-90	Level 4: cake tin on rack Level 1: cake tin on rack
Filled pies (cheesecake, strudel, apple pie)		-	2	160-200	35-90	Drip-tray / baking tray or cake tin on rack
		-	1-4	160-200	40-90	Level 4: cake tin on rack Level 1: cake tin on rack
Biscuits / Tartlets		-	3	170-180	20-45	Drip-tray or baking tray
		-	1-4	160-170	20-45	Level 4: rack Level 1: drip-tray or baking tray
		-	1-3-5	160-170	20-45*	Level 5: pan on rack Level 3: pan on rack Level 1: drip-tray or baking tray
Choux buns		-	3	180-200	30-40	Drip-tray or baking tray
		-	1-4	180-190	35-45	Level 4: pan on rack Level 1: drip-tray or baking tray
		-	1-3-5	180-190	35-45*	Level 5: pan on rack Level 3: pan on rack Level 1: drip-tray or baking tray
Meringues		-	3	90	110-150	Drip-tray or baking tray
		-	1-4	90	140-160	Level 4: pan on rack Level 1: drip-tray or baking tray
		-	1-3-5	90	140-160*	Level 5: pan on rack Level 3: pan on rack Level 1: drip-tray or baking tray
Bread / Pizza / Focaccia		-	1 / 2	190-250	15-50	Drip-tray or baking tray
		-	1-4	190-250	20-50	Level 4: pan on rack Level 1: drip-tray or baking tray
		-	1-3-5	190-250	25-50*	Level 5: pan on rack Level 3: pan on rack Level 1: drip-tray or baking tray

Recipe	Function	Pre-heating	Shelf (from bottom)	Temp. (°C)	Time (min)	Accessories and notes
Savoury pies (vegetable pie, quiche lorraine)		-	2	180-190	40-55	Cake tin on rack
		-	1-4	180-190	45-70	Level 4: cake tin on rack Level 1: cake tin on rack
		-	1-3-5	180-190	45-70*	Level 5: cake tin on rack Level 3: cake tin on rack Level 1: drip-tray or baking tray + cake tin
		-	1-3-5	180-190	45-70*	Level 5: pan on rack Level 3: pan on rack Level 1: drip-tray or baking tray
Vols-au-vent / Puff pastry savouries		-	3	190-200	20-30	Drip-tray or baking tray
		-	1-4	180-190	20-40	Level 4: pan on rack Level 1: drip-tray or baking tray
		-	1-3-5	180-190	20-40*	Level 5: pan on rack Level 3: pan on rack Level 1: drip-tray or baking tray
Lasagna / Baked pasta / Cannelloni / Flans		-	3	190-200	45-55	Pan on rack
Lamb / Veal / Beef / Pork 1 Kg		-	3	190-200	80-110	Drip-tray or pan on rack
Chicken / Rabbit / Duck 1 Kg		-	3	200-230	50-100	Drip-tray or pan on rack
Turkey / Goose 3 Kg		-	2	190-200	80-130	Drip-tray or pan on rack
Baked fish / en papillote (fillet, whole)		-	3	180-200	40-60	Drip-tray or pan on rack
Stuffed vegetables (tomatoes, courgettes, aubergines)		-	2	180-200	50-60	Pan on rack
Toast		-	5	High	3-6	Rack
Fish fillets / steaks		-	4	Medium	20-30	Level 4: rack (turn food halfway through cooking)
						Level 3: drip-tray with water
Sausages / Kebabs / Spare ribs / Hamburgers		-	5	Medium-High	15-30	Level 5: rack (turn food halfway through cooking)
						Level 4: drip-tray with water
Roast chicken 1-1.3 Kg		-	2	Medium	55-70	Level 2: rack (turn food two thirds of the way through cooking)
			2	High	60-80	Level 1: drip-tray with water
Roast beef rare 1 Kg		-	3	Medium	35-45	Level 2: turnspit (if present)
						Level 1: drip-tray with water
Leg of lamb / Shanks		-	3	Medium	60-90	Pan on rack (turn food two thirds of the way through cooking if necessary)
Leg of lamb / Shanks		-	3	Medium	60-90	Drip-tray or pan on rack (turn food two thirds of the way through cooking if necessary)

Recipe	Function	Pre-heating	Shelf (from bottom)	Temp. (°C)	Time (min)	Accessories and notes
Baked potatoes		-	3	Medium	45-55	Drip-tray or baking tray (turn food two thirds of the way through cooking if necessary)
Vegetables au gratin		-	3	High	10-15	Pan on rack
Lasagna & Meat		-	1-4	200	50-100*	Level 4: pan on rack Level 1: drip-tray or pan on rack
Meat & Potatoes		-	1-4	200	45-100*	Level 4: pan on rack Level 1: drip-tray or pan on rack
Fish & Vegetables		-	1-4	180	30-50*	Level 4: pan on rack Level 1: drip-tray or pan on rack
Complete meal: Tart (Level 5) / Lasagna (Level 3) / Meat (Level 1)		-	1-3-5	190	40-120*	Level 5: pan on rack Level 3: pan on rack Level 1: drip-tray or pan on rack
Frozen pizza		-	3	Auto	10-15	Drip-tray / baking tray or rack
		-	1-4	Auto	15-20	Level 4: pan on rack Level 1: drip-tray or baking tray
		-	1-3-5	Auto	20-30	Level 5: pan on rack Level 3: drip-tray or baking tray Level 1: pan on rack
		-	1-3-4-5	Auto	20-30	Level 5: pan on rack Level 4: drip-tray or baking tray Level 3: drip-tray or baking tray Level 1: pan on rack
		-	3	Auto	10-15	Drip-tray / baking tray or rack
		-	1-4	Auto	15-20	Level 4: pan on rack Level 1: drip-tray or baking tray
Filled roast meats		-	3	200	80-120*	Drip-tray or pan on rack
Meat cuts (rabbit, chicken, lamb)		-	3	200	50-100*	Drip-tray or pan on rack

* Cooking time is approximate. Food can be removed from the oven at different times depending on personal preference.

TESTED RECIPES in compliance with IEC 50304 / 60350:2009-03 and DIN 3360-12:07:07

Recipe	Function	Pre-heating	Shelf (from bottom)	Temp. (°C)	Time (min)	Accessories and notes
IEC 60350:2009-03 § 8.4.1						
Shortbread		-	3	170	15-30	Drip-tray / baking tray
		-	1-4	160	20-35	Level 4: baking tray Level 1: drip-tray
IEC 60350:2009-03 § 8.4.2						
Small cakes		-	3	170	25-35	Drip-tray / baking tray
		-	1-4	160	30-40	Level 4: baking tray Level 1: drip-tray
IEC 60350:2009-03 § 8.5.1						
Fatless sponge cake		-	2	170	30-40	Cake tin on rack
IEC 60350:2009-03 § 8.5.2						
Two apple pies		-	2 / 3	185	70-90	Cake tin on rack
		-	1-4	175	75-95	Level 4: cake tin on rack Level 1: cake tin on rack
IEC 60350:2009-03 § 9.1.1						
Toast**		-	5	High	3-6	Rack
IEC 60350:2009-03 § 9.2.1						
Burgers**		-	5	High	18-30	Level 5: rack (turn food halfway through cooking) Level 4: drip-tray with water
DIN 3360-12:07 § 6.5.2.3						
Apple cake, yeast tray cake		-	3	180	35-45	Drip-tray / baking tray
		-	1-4	160	55-65	Level 4: baking tray Level 1: drip-tray
DIN 3360-12:07 § 6.6						
Roast pork		-	2	170	110-150	Level 2: drip-tray
DIN 3360-12:07 annex C						
Flat cake		-	3	170	40-50	Drip-tray / baking tray
		-	1-4	160	45-55	Level 4: baking tray Level 1: drip-tray

The cooking table advises the ideal function and temperature to ensure the best results with all recipes. If you wish to cook on one shelf only using the fan-assisted function, place food on the third shelf and select the temperature recommended for the "FORCED AIR" function on more than one shelf.

The indications in the table are without use of the runners. Do the tests without the runners.

** When grilling food, it is advisable leave a space of 3-4 cm from the front edge of the grill to facilitate removal

Energy efficiency class (according to EN 50304)

To do the test, use the dedicated table.

Energy consumption and preheating time

Select the function and do the test only with the "Preheating" option activated ("Preheating yes").

Control Accuracy test

Select the function and do the test only with the "Preheating" option deactivated (when preheating is activated, the oven control intentionally creates an oscillation of the temperature profile).

RECOMMENDED USE AND TIPS

How to read the cooking table

The table indicates the best function to use for any given food, to be cooked on one or more shelves at the same time. Cooking times start from the moment food is placed in the oven, excluding pre-heating (where required). Cooking temperatures and times are purely for guidance and will depend on the amount of food and type of accessory used. Use the lowest recommended values to begin with and, if the food is not cooked enough, then move on to higher values. Use the accessories supplied and preferably dark coloured metal cake tins and oven trays. You can also use pans and accessories in pyrex or stoneware, but bear in mind that cooking times will be slightly longer. To obtain best results, carefully follow the advice given in the cooking table for the choice of accessories (supplied) to be placed on the various shelves.

Cooking different foods at the same time

Using the "FORCED AIR" function, you can cook different foods which require the same cooking temperature at the same time (for example: fish and vegetables), using different shelves. Remove the food which requires less cooking time and leave food which requires longer cooking time in the oven.

Desserts

- Cook delicate desserts with the conventional function on one shelf only. Use dark coloured metal cake tins and always position them on the wire shelf supplied. To cook on more than one shelf, select the forced air function and stagger the position of the cake tins on the shelves, aiding optimum circulation of the hot air.
- To check whether a raising cake is cooked, insert a wooden toothpick into the centre of the cake. If the toothpick comes out clean, the cake is ready.
- If using non-stick cake tins, do not butter the edges as the cake may not rise evenly around the edges.
- If the cake "sinks" during cooking, set a lower temperature the next time, perhaps reducing the amount of liquid in the mixture and mixing more gently.
- For sweets with moist fillings (cheesecake or fruit pies) use the "CONVECTION BAKE" function. If the base of the cake is soggy, lower the shelf and sprinkle the bottom of the cake with bread crumbs or biscuit crumbs before adding the filling.

Meat

- Use any kind of oven tray or pyrex dish suited to the size of the piece of meat being cooked. For roast joints, it is best to add some stock to the bottom of the pan, basting the meat during cooking for added flavour. When the roast is ready, let it rest in the oven for another 10 - 15 minutes, or wrap it in aluminium foil.
- When you want to grill meat, choose cuts with an even thickness all over in order to achieve uniform cooking results. Very thick pieces of meat require longer cooking times. To prevent the meat from burning on the outside, lower the position of the wire shelf, keeping the food farther away from the grill. Turn the meat two thirds of the way through cooking.

To collect the cooking juices it is advisable to place a drip-tray with half a litre of water directly under the grill on which the meat is placed. Top-up when necessary.

Pizza

Lightly grease the trays to ensure the pizza has a crispy base. Scatter the mozzarella over the pizza two thirds of the way through cooking.

Rising function

It is always best to cover the dough with a damp cloth before placing it in the oven. Dough proving time with this function is reduced by approximately one third compared to proving at room temperature (20-25°C). Proving time for a 1 Kg batch of pizza dough is around one hour.

Cooking in Induction Mode

- Always position the cooking vessel in the centre of the induction plate to ensure uniform cooking heat.
- The induction plate may be pulled out to check or stir the food and the door can be kept open during this operation.
- It is advisable to use baking parchment for any meat or fish dishes because, as well as guaranteeing optimum cooking results, it also allows better and faster cleaning of the induction plate, especially when sauces are used.

- When using the roast Meat and whole roast Chicken functions, the meat does not need to be turned over.
- **For the "Roast beef" function: after cooking for 15 minutes it is recommended that the meat is turned to achieve even surface browning. When the beef is cooked to your liking take it out of the oven and leave to rest.**
- For fruit flans and other delicate dishes, it is advisable to prick the pastry case before filling it to avoid air bubbles forming and, after cooking, let the food cool down inside the cooking vessel.
- Pizza toppings should be added based on the height of the dough base and the quantity of sauce used.
- Pizzas with very thin bases and only light toppings can be cooked cold; otherwise it is advisable to consider the most suitable time to add the topping, half way through or at the end of the cooking time.
- For delicate preparations such as cakes, it is advisable to let the cooking vessel cool down before inserting the food if it has just been used to prepare another dish.
- Consecutive cooking may be done for larger dishes (for example: pizzas, roasts, etc.).
- For roast vegetables or small pieces of meat it is advisable to stir the food during cooking in order to ensure uniform browning. The weight indicated for the category refers to a single piece not the total weight (e.g. several 600gr pieces may be cooked at once in the 0.6-0.8 Kg category).

Printed in Italy
02/2012

5019 300 01348



Whirlpool is a registered trademark of Whirlpool, USA

Free Manuals Download Website

<http://myh66.com>

<http://usermanuals.us>

<http://www.somanuals.com>

<http://www.4manuals.cc>

<http://www.manual-lib.com>

<http://www.404manual.com>

<http://www.luxmanual.com>

<http://aubethermostatmanual.com>

Golf course search by state

<http://golfingnear.com>

Email search by domain

<http://emailbydomain.com>

Auto manuals search

<http://auto.somanuals.com>

TV manuals search

<http://tv.somanuals.com>