

AKZ 562

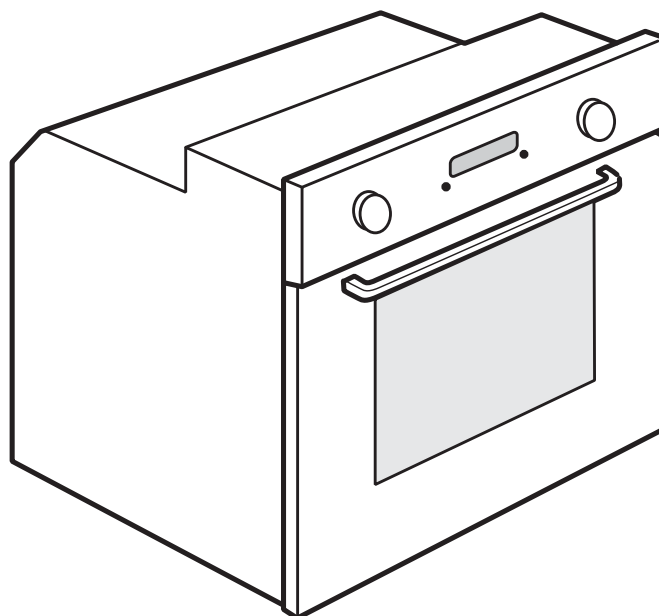

EN

User and maintenance manual

CS

Návod k použití a údržbě

SK

Návod na používanie a údržbu

HU

Felhasználói és karbantartási kézikönyv

RO

Manual de utilizare și întreținere



IMPORTANT SAFETY INSTRUCTIONS

These instructions shall also be available on website: www.whirlpool.eu

YOUR SAFETY AND THAT OF OTHERS IS VERY IMPORTANT

This manual and the appliance itself provide important safety warnings, to be read and observed at all times.



This is the danger symbol, pertaining to safety, which alerts users to potential risks to themselves and others. All safety warnings are preceded by the danger symbol and the following terms:

! DANGER

Indicates a hazardous situation which, if not avoided, will cause serious injury.

! WARNING

Indicates a hazardous situation which, if not avoided, could cause serious injury.

All safety warnings give specific details of the potential risk present and indicate how to reduce risk of injury, damage and electric shock resulting from improper use of the appliance. Carefully observe the following instructions:

- Use protective gloves to perform all unpacking and installation operations.
- The appliance must be disconnected from the power supply before carrying out any installation work.
- Installation and maintenance must be carried out by a qualified technician, in compliance with the manufacturer's instructions and local safety regulations. Do not repair or replace any part of the appliance unless specifically stated in the user manual.
- Power cable replacement must be carried out by a qualified electrician. Contact an authorized service centre.
- Regulations require that the appliance is earthed.
- The power cable must be long enough for connecting the appliance, once fitted in its housing, to the main power supply.
- For installation to comply with current safety regulations, an all-pole disconnect switch with minimum contact gap of 3 mm must be utilized.
- Do not use multiple plug adaptors if the oven is fitted with a plug.
- Do not use extension leads.
- Do not pull the power supply cable.
- The electrical components must not be accessible to the user after installation.
- If the surface of the induction plate is cracked, do not use it and switch off the appliance to avoid the possibility of electric shock (only for models with induction function).

- Do not touch the appliance with any wet part of the body and do not operate it when barefoot.
- This appliance is designed solely for use as a domestic appliance for cooking food. No other type of use is permitted (e.g.: heating rooms). The Manufacturer declines all responsibility for inappropriate use or incorrect setting of the controls.
- The appliance and its accessible parts become hot during use. Care should be taken to avoid touching heating elements. Very young (0-3 years) and young children (3-8 years) shall be kept away unless continuously supervised.
- Children from 8 years and above and persons with reduced physical, sensory or mental capabilities or lack of experience and knowledge can use this appliance only if they are supervised or have been given instructions on safe appliance use and if they understand the hazards involved. Children shall not play with the appliance. Cleaning and user maintenance shall not be made by children without supervision.
- During and after use, do not touch the heating elements or interior surfaces of the appliance - risk of burns. Do not allow the appliance to come into contact with cloths or other flammable materials until all the components have cooled down completely.
- At the end of cooking, exercise caution when opening the appliance door, letting the hot air or steam exit gradually before accessing the oven. When the appliance door is shut, hot air is vented from the aperture above the control panel. Do not obstruct the vent apertures.
- Use oven gloves to remove pans and accessories, taking care not to touch the heating elements.
- Do not place flammable materials in or near the appliance: a fire may break out if the appliance is inadvertently switched on.
- Do not heat or cook sealed jars or containers in the appliance. The pressure that builds up inside might cause the jar to explode, damaging the appliance.
- Do not use containers made of synthetic materials.
- Overheated oils and fats catch fire easily. Always remain vigilant when cooking foods rich in fat and oil.

- Never leave the appliance unattended during food drying.
- If alcoholic beverages are used when cooking foods (e.g. rum, cognac, wine), remember that alcohol evaporates at high temperatures. As a result, there is a risk that vapours released by the alcohol may catch fire upon coming into contact with the electrical heating element.
- Never use steam cleaning equipment.
- Do not touch the oven during the pyrolysis cycle. Keep children away from the oven during the pyrolysis cycle. Excess spillage must be removed from the oven cavity before cleaning cycle (only for ovens with Pyrolysis function).
- Only use the temperature probe recommended for this oven.
- Do not use harsh abrasive cleaners or sharp metal scrapers to clean the oven door glass since they can scratch the surface, which may result in shattering of the glass.
- Ensure that the appliance is switched off before replacing the lamp to avoid the possibility of electric shock.
- Do not use aluminium foil to cover food in the cooking vessel (only for ovens with cooking vessel supplied).

Scrapping of household appliances

- This appliance is manufactured with recyclable or reusable materials. Dispose of it in accordance with local waste disposal regulations. Before scrapping, cut off the power supply cable.
- For further information on the treatment, recovery and recycling of household electrical appliances, contact your competent local authority, the collection service for household waste or the store where you purchased the appliance.

INSTALLATION

After unpacking the oven, make sure that it has not been damaged during transport and that the oven door closes properly. In the event of problems, contact the dealer or your nearest After-sales Service. To prevent any damage, only remove the oven from its polystyrene foam base at the time of installation.

PREPARING THE HOUSING UNIT

- Kitchen units in contact with the oven must be heat resistant (min 90°C).
- Carry out all cabinet cutting work before fitting the oven in the housing and carefully remove all wood chips and sawdust.
- After installation, the bottom of the oven must no longer be accessible.
- For correct appliance operation, do not obstruct the minimum gap between the worktop and the upper edge of the oven.

ELECTRICAL CONNECTION

Make sure the power voltage specified on the appliance dataplate is the same as the mains voltage. The dataplate is on the front edge of the oven (visible when the door is open).

- Power cable replacement (type H05 RR-F 3 x 1.5 mm²) must be carried out by a qualified electrician. Contact an authorized service centre.

GENERAL RECOMMENDATIONS

Before use:

- Remove cardboard protection pieces, protective film and adhesive labels from accessories.
- Remove the accessories from the oven and heat it at 200° for about an hour to eliminate the smell and fumes from the insulating materials and protective grease.

During use:

- Do not place heavy objects on the door as they could damage it.
- Do not cling to the door or hang anything from the handle.
- Do not cover the inside of the oven with aluminium foil.
- Never pour water into the inside of a hot oven; this could damage the enamel coating.
- Never drag pots or pans across the bottom of the oven as this could damage the enamel coating.
- Make sure that the electrical cables of other appliances do not touch hot parts of the oven or become trapped in the door.
- Do not expose the oven to atmospheric agents.

SAFEGUARDING THE ENVIRONMENT

Disposal of packing material

The packing material is 100% recyclable and is marked with the recycle symbol (♻️). The various parts of the packing must therefore be disposed of responsibly and in full compliance with local authority regulations governing waste disposal.

Scrapping the product

- This appliance is marked in compliance with European Directive 2002/96/EC, Waste Electrical and Electronic Equipment (WEEE).
- By ensuring this product is disposed of correctly, you will help prevent potential negative consequences for the environment and human health, which could otherwise be caused by inappropriate waste handling of this product.
- The symbol  on the product or on the accompanying documentation indicates that it should not be treated as domestic waste but must be taken to an appropriate collection centre for the recycling of electrical and electronic equipment.

Energy saving

- Only pre-heat the oven if specified in the cooking table or your recipe.
- Use dark lacquered or enamelled baking moulds as they absorb heat far better.
- Switch the oven off 10/15 minutes before the set cooking time. Food requiring prolonged cooking will continue to cook even once the oven is switched off.

DECLARATION OF CONFORMITY (C E)

- This oven, which is intended to come into contact with foodstuffs, complies with European Regulation (C E) n.1935/2004 and has been designed, manufactured and sold in conformity with the safety requirements of the "Low Voltage" directive 2006/95/CE (which replaces 73/23/CEE and subsequent amendments), the protection requirements of "EMC" 2004/108/CE.

TROUBLESHOOTING GUIDE

The oven does not work:

- Check for the presence of mains electrical power and if the oven is connected to the electrical supply.
- Turn off the oven and restart it to see if the fault persists.

The door will not open:

- Turn off the oven and restart it to see if the fault persists.
- **Important:** during self-cleaning, the oven door will not open. Wait until it unlocks automatically (see paragraph "Cleaning cycle of ovens with pyrolysis function").

The electronic programmer does not work:

- If the display shows the letter "F" followed by a number, contact your nearest After-sales Service. Specify in this case the number that follows the letter "F".

AFTER-SALES SERVICE

Before calling the After-Sales Service:

1. See if you can solve the problem yourself with the help of the suggestions given in the "Troubleshooting guide".
2. Switch the appliance off and back on again it to see if the fault persists.

If after the above checks the fault still occurs, get in touch with the nearest After-sales Service.

Always specify:

- a brief description of the fault;
- the type and exact model of the oven;
- the service number (number after the word Service on the rating plate), located on the right hand edge of the oven cavity (visible when the oven door is open). The service number is also indicated on the guarantee booklet;

- your full address;
- your telephone number.

SERVICE 0000 000 00000



If any repairs are required, please contact an authorised **After-sales Service** (to guarantee that original spare parts will be used and repairs carried out correctly).

CLEANING



WARNING

- **Never use steam cleaning equipment.**
- **Only clean the oven when it is cool to the touch.**
- **Disconnect the appliance from the power supply.**

Oven exterior

IMPORTANT: do not use corrosive or abrasive detergents. If any of these products accidentally comes into contact with the appliance, clean immediately with a damp microfibre cloth.

- Clean the surfaces with a damp microfibre cloth. If it is very dirty, add a few drops of washing up detergent to the water. Finish off with a dry cloth.

Oven interior

IMPORTANT: do not use abrasive sponges or metallic scrapers or scourers. Over time, these can ruin enamelled surfaces and the oven door glass.

- After every use, allow the oven to cool then clean it preferably while it is still warm in order to remove built-up dirt and stains caused by food residues (e.g. food with a high sugar content).
- Use proprietary oven detergents and follow the manufacturer's instructions to the letter.
- Clean the door glass with a suitable liquid detergent. The oven door can be removed to facilitate cleaning (see MAINTENANCE).
- The top heating element of the grill (see MAINTENANCE) can be lowered (some models only) to clean the roof of the oven.

N.B.: during prolonged cooking of foods with a high water content (e.g. pizza, vegetables, etc.) condensation may form on the inside of the door and around the seal. When the oven is cold, dry the inside of the door with a cloth or sponge.

Accessories:

- Soak the accessories in water with washing up detergent immediately after use, handling them with oven gloves if still hot.
- Food residues can be easily removed using a brush or sponge.

Cleaning the rear wall and catalytic side panels of the oven (if present):

IMPORTANT: do not use corrosive or abrasive detergents, coarse brushes, pot scourers or oven sprays which could damage the catalytic surface and ruin its self-cleaning properties.

- Operate the oven empty with the fan-assisted function at 200°C for about one hour
- Next, leave the appliance to cool down before removing any food residue with a sponge.

Cleaning cycle of ovens with pyrolysis function:



WARNING

- **Do not touch the oven during the pyrolysis cycle.**
- **Keep children away from the oven during the pyrolysis cycle.**

This function burns off spatters produced inside the oven during cooking at a temperature of approx. 500°C. At this high temperature, the deposits turn into a light ash which can be easily wiped away with a damp cloth, when the oven is cool. Do not select the pyrolysis function after every use, only when the oven is very dirty or produces smoke or fumes while preheating or cooking.

- If the oven is installed below a hob, make sure that all burners or electric hotplates are switched off during the self-cleaning (pyrolysis) function.
- Remove all accessories before running the pyrolysis function (also the lateral grids).
- For optimum cleaning of the oven door, remove the worst soiling with a damp sponge before using the pyrolytic function. The appliance is equipped with 2 pyrolysis functions:
 1. Energy-saving cycle (PYRO EXPRESS/ECO): which consumes approximately 25% less energy than the standard cycle. Select it at regular intervals (after cooking meat on 2 or 3 consecutive occasions).
 2. Standard cycle (PYRO): which is suitable for cleaning a very dirty oven.
- In any case, after a certain number of uses and depending on how dirty the oven is, a message on the oven display advises you to run a self-cleaning cycle.

N.B.: during the pyrolysis function, the oven door will not open; it will remain locked until the temperature inside the oven has returned to an acceptably safe level.

MAINTENANCE

WARNING

- Use protective gloves.
- Ensure the oven is cold before carrying out the following operations.
- Disconnect the appliance from the power supply.

REMOVING THE DOOR

To remove the door:

1. Open the door fully.
2. Lift the catches and push them forwards as far as they will go (fig. 1).
3. Close the door as far as it will go (A), lift it up (B) and turn it (C) until it is released (D) (fig. 2).

To refit the door:

1. Insert the hinges in their seats.
2. Open the door fully.
3. Lower the two catches.
4. Close the door.

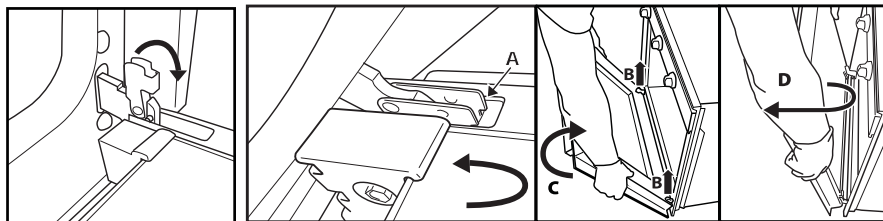

Fig. 1

Fig. 2

MOVING THE TOP HEATING ELEMENT (SOME MODELS ONLY)

1. Remove the side accessory holder grilles (Fig. 3).
2. Pull the heating element out a little (Fig. 4) and lower it (Fig. 5).
3. To reposition the heating element, lift it up, pulling it slightly towards you, making sure it comes to rest on the lateral supports.

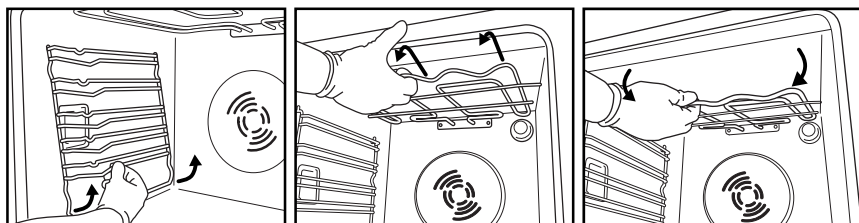

Fig. 3

Fig. 4

Fig. 5

REPLACING THE OVEN LAMP

To replace the rear lamp (if present):

1. Disconnect the oven from the power supply.
2. Unscrew the lamp cover (Fig. 6), replace the lamp (see note for lamp type) and screw the lamp cover back on.
3. Reconnect the oven to the power supply.

To replace the side lamp (if present):

1. Disconnect the oven from the power supply.
2. Remove the side accessory holder grilles, if present (Fig. 3).
3. Use a screwdriver to prise off the lamp cover (Fig. 7).
4. Replace the lamp (see note for lamp type) (Fig. 8).
5. Reposition the lamp cover, pushing it on firmly until it snaps into place (Fig. 9).
6. Refit the side accessory holder grilles.
7. Reconnect the oven to the power supply.

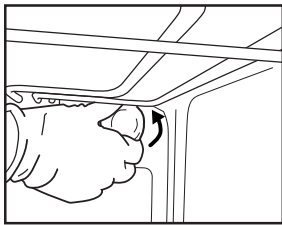

Fig. 6

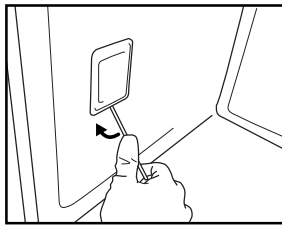

Fig. 7

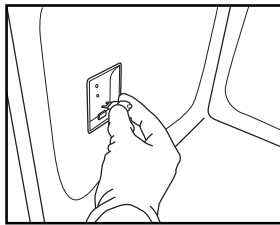

Fig. 8

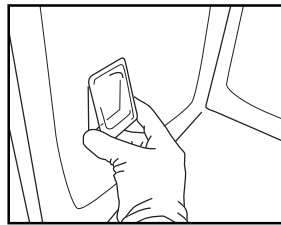

Fig. 9

N.B.:

- Only use 25-40W/230V type E-14, T300°C incandescent lamps, or 20-40W/230 V type G9, T300°C halogen lamps.
- The lamp used in the appliance is specifically designed for electrical appliances and is not suitable for household room illumination (Commission Regulation (EC) No 244/2009).
- Lamps are available from our After-sales Service.

IMPORTANT:

- **If using halogen lamps, do not handle with bare hands since fingerprints can damage them.**
- **Do not use the oven until the lamp cover has been repositioned.**

INSTRUCTIONS FOR OVEN USE

FOR ELECTRICAL CONNECTION, SEE THE PARAGRAPH ON INSTALLATION

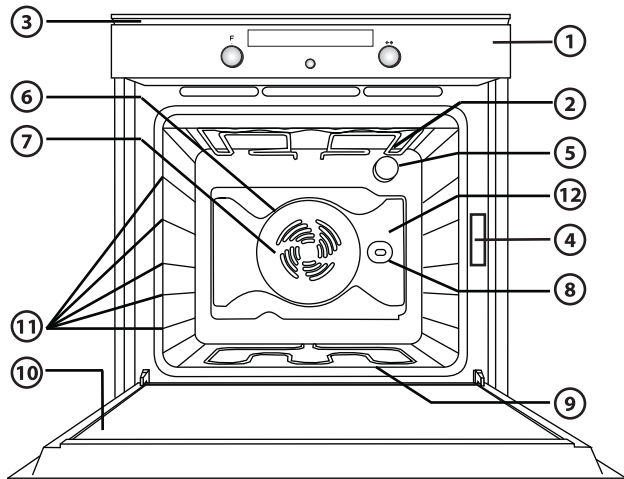

1. Control panel
2. Upper heating element/grill
3. Cooling fan (not visible)
4. Dataplate (not to be removed)
5. Lamp
6. Circular heating element (not visible)
7. Fan
8. Turnspit (if present)
9. Lower heating element (not visible)
10. Door
11. Position of shelves (the number of shelves is indicated on the front of the oven)
12. Rear wall

N.B.:

- During cooking, the cooling fan may switch on at intervals in order to minimise energy consumption.
- At the end of cooking, after the oven has been switched off, the cooling fan may continue to run for a while.
- When the oven door is opened during cooking, the heating elements switch off.

ACCESSORIES SUPPLIED

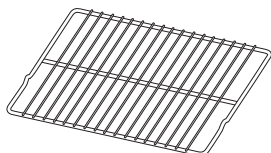

Fig. A

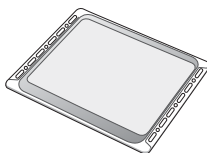

Fig. B

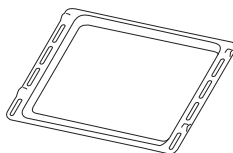

Fig. C

- A. WIRE SHELF:** the wire shelf can be used to grill food or as a support for pans, cake tins and other ovenproof cooking receptacles.
- B. BAKING TRAY:** the baking tray can be used to cook bread and pastry products, as well as roast meat, fish en papillote, etc.
- C. DRIP TRAY:** the drip tray is designed to be positioned under the wire shelf in order to collect fat or as an oven tray for cooking meat, fish, vegetables, focaccia, etc.

The number of accessories may vary according to which model is purchased.

ACCESSORIES NOT SUPPLIED

Other accessories which can be purchased separately from the After-sales Service include, catalytic panels and a turnspit.

INSERTING WIRE SHELVES AND OTHER ACCESSORIES IN THE OVEN

1. Insert the wire shelf horizontally, with the raised part "A" upwards (fig. 1).
2. The other accessories, like the drip tray and baking tray, are inserted with the raised part on the flat section "B" facing upwards (fig. 2).

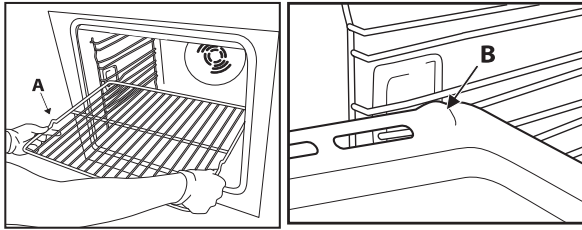
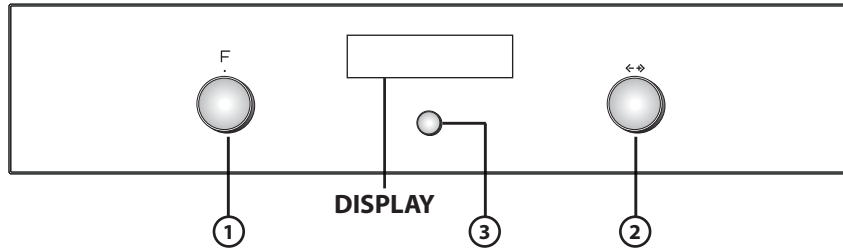

Fig. 1

Fig. 2

CONTROL PANEL DESCRIPTION

ELECTRONIC PROGRAMMER



1. **FUNCTION SELECTOR KNOB:** On/off and function selector knob
2. **BROWSE KNOB:** for browsing the menu and adjusting pre-set values

N.B.: the control knobs are retractable. Press the knobs in the middle and they pop up.

3. **SELECTION/CONFIRMATION BUTTON**

N.B.: the display shows ✓ for indications regarding this button.

LIST OF FUNCTIONS

Turn the "Functions" knob to any position and the oven switches on: the display shows the functions or the associated submenus.

The submenus are available and selectable by turning the knob to the functions GRILL, SPECIALS, SETTINGS, BREAD/PIZZA, AUTOMATIC OVEN CLEANING.

N.B.: for the list and description of functions, see the specific table at pag. 14.

DESCRIPTION OF DISPLAY

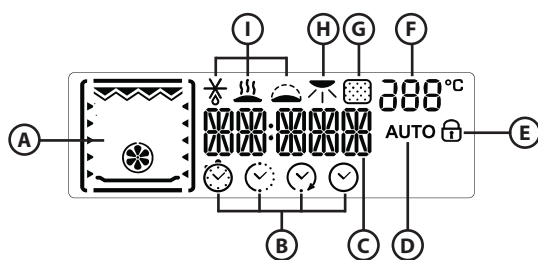

- A. Display of heating elements activated during the various cooking functions
- B. Time management symbols: timer, cooking time, end of cooking time, time
- C. Information regarding selected functions
- D. Automatic BREAD/PIZZA function selected
- E. Indication of door locked during automatic cleaning cycle (pyro-cleaning)
- F. Internal oven temperature
- G. Pyrolysis function
- H. Browning
- I. Special functions: defrosting, keep warm, rising

STARTING THE OVEN - SETTING LANGUAGE

At the first switch on of the oven, display shows ENGLISH.

Turn the "Browse" knob until the desired language is displayed then press the button ③ to confirm.

SETTING THE TIME

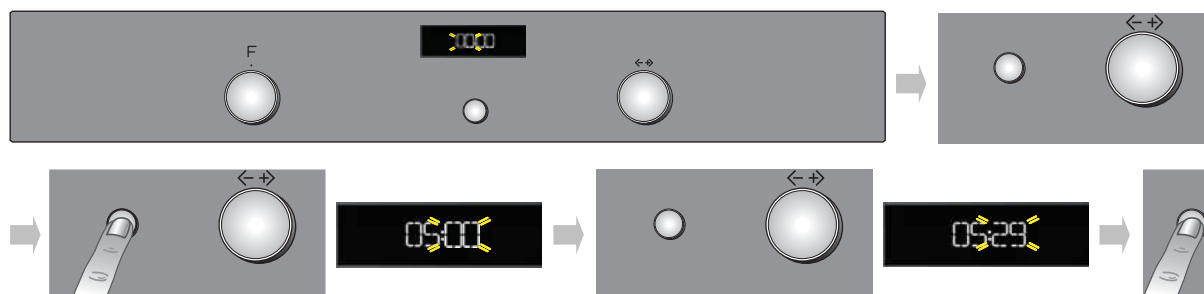

After setting the language, the time must be set on the clock. The two hour digits flash on the display.

1. Turn the "Browse" knob to display the correct hour.
2. Press the button (3) to confirm; the two minute digits flash on the display.
3. Turn the "Browse" knob to display the correct minutes.
4. Press button (3) to confirm.

To change the time, for example following a power cut, see the next paragraph (SETTINGS).

SELECTING COOKING FUNCTIONS

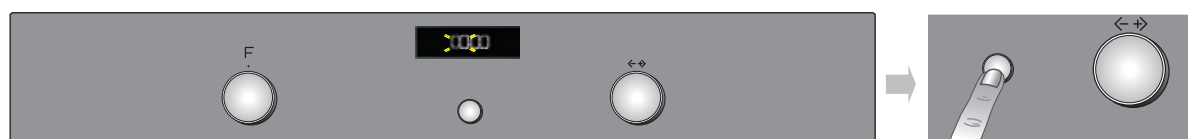

1. Turn the "Functions" knob to the desired function: the cooking settings are shown on the display.
2. If the values shown are those desired, press (3). To change them, proceed as indicated below.

SETTING THE TEMPERATURE/OUTPUT OF THE GRILL

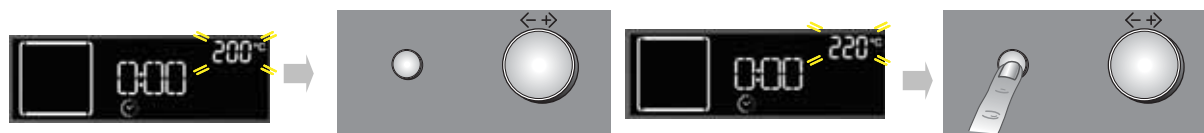

To change the temperature or output of the grill, proceed as follows:

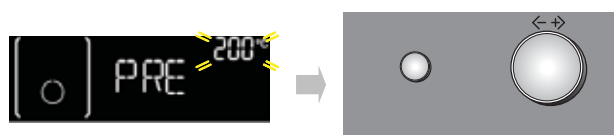

1. Turn the "Browse" knob to display the desired value.
2. Press button (3) to confirm.

FAST PREHEATING



1. Turn the "Functions" knob to the symbol  to select the fast preheating function.
2. Confirm by pressing (3): the settings are shown on the display.
3. If the proposed temperature is that desired, press button (3). To change the temperature, proceed as described in previous paragraphs. The message **PRE** appears on the display. When the set temperature is reached, the corresponding value (e.g. 200°) and an acoustic signal will sound. At the end of preheating, the oven automatically selects the conventional function .
- At this point food can be placed in the oven for cooking.
4. If you wish to set a different cooking function, turn the "Functions" knob and select the desired function.

SETTING COOKING TIME

This function can be used to cook food for a set length of time, from a minimum of 1 minute to the maximum time allowed by the selected function, after which the oven switches off automatically.

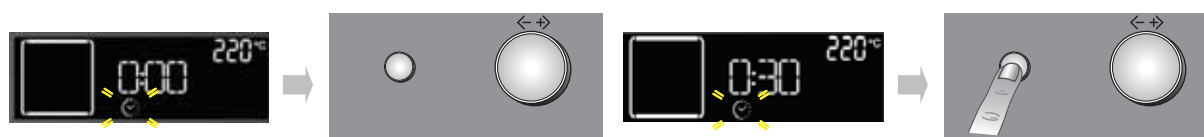

1. Once the temperature is confirmed, the symbol  flashes.
2. Turn the adjustment knob to display the desired cooking time.
3. To confirm the cooking time, press button (3).

SETTING END OF COOKING TIME /START DELAYED

IMPORTANT: the start delayed setting is not available for the following functions: FAST PREHEATING, BREAD/PIZZA.
N.B.: with this setting, the selected temperature is reached in a more gradual way, so cooking times will be slightly longer than stated in the cooking table.

The end of cooking time can be set, delaying the start of cooking by up to a maximum of 23 hours and 59 minutes. This can only be done once cooking time has been set.

After setting cooking time, the display shows the end of cooking time (for example 15:45) and the symbol  flashes.

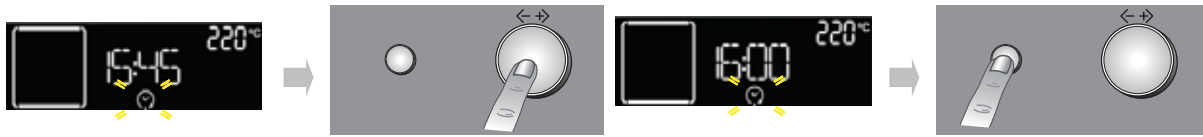



To delay the end of cooking time, and thus also the cooking start time, proceed as follows:

1. Turn the "Browse" knob to display the time you wish cooking to end (for example 16:00).
2. Confirm the selected value by pressing button : the two dots of end of cooking time flash, indicating that the setting has been made correctly.
3. The oven will automatically delay the start of cooking so as to finish cooking at the set time.

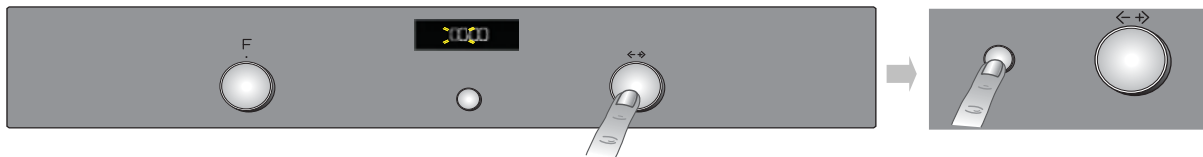
TIMER



This function can be used only with the oven switched off and is useful, for example, for monitoring the cooking time of pasta. The maximum time which can be set is 23 hours and 59 minutes.



1. With the "Functions" knob at zero, turn the "Browse" knob to display the desired time.
2. Press button  to start the countdown. When the set time has elapsed, the display will show "END" and an acoustic signal will sound. To mute the acoustic signal, press button  (the time of day appears on the display).

SELECTING SPECIAL FUNCTIONS

Turn the "Functions" knob indicator to the symbol  to access a submenu containing special functions.

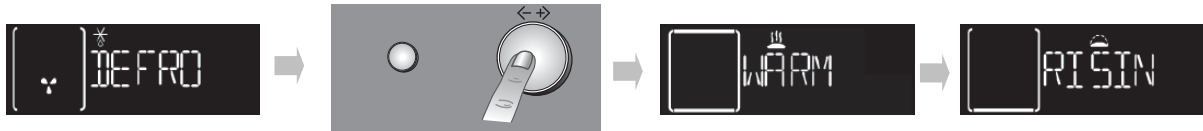
To browse, select and start one of these functions, proceed as follows:



1. Turn the "Functions" knob to symbol : the display shows "DEFROST" along with this function's corresponding symbol.
2. Turn the "Browse" knob to scroll the list of functions: DEFROST, KEEP WARM, RISING, ECO FORCED AIR.
3. Press button  to confirm.

BROWNING

At the end of cooking, with certain functions, the display indicates the possibility of extra browning. This function can only be used when cooking time has been set.

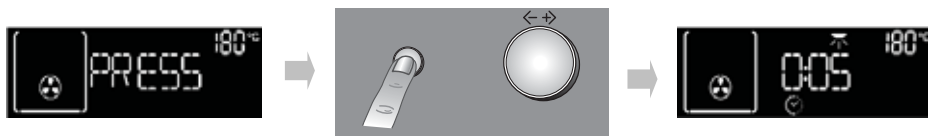

At the end of cooking time, the display shows: "PRESS ✓ TO BROWN". Press button , and the oven starts a 5 minute browning cycle. This function can be selected consecutively a maximum of twice.

BREAD/PIZZA FUNCTION SELECTION

Turn the "Functions" knob indicator to the symbol  to access a submenu containing two automatic cooking functions for "bread" and "pizza".

Bread



1. Turn the "Functions" knob to symbol : the display shows "BREAD" and AUTO at the side.
2. Press **3** to select the function.
3. Turn the "Browse" knob to set the required temperature (between 180°C and 220°C) and confirm with button **3**.
4. Turn the "Browse" knob to set the required cooking duration and press **3** to start cooking.

Pizza



1. Turn the Functions knob to symbol : the display shows "BREAD". To select the "PIZZA" function, proceed as follows:
2. Turn the "Browse" knob: "PIZZA" appears on the display.
3. Press **3** to select the function.
4. Turn the "Browse" knob to set the required temperature (between 220°C and 250°C) and confirm with button **3**.
5. Turn the "Browse" knob to set the required cooking duration and press **3** to start cooking.

SETTINGS

Turn the "Functions" knob indicator to the symbol  to access a submenu containing five display settings which can be changed.

Language

1. Turn the "Browse" knob to display "LANGUAGE".
2. Press **3** to access the setting.
3. Turn the "Browse" knob to select the desired language and confirm by pressing button **3**.

Clock

Turn the "Browse" knob to display CLOCK. To change the time, see the previous section (SETTING THE CURRENT TIME).

Eco

With the ECO mode selected (ON), the display reduces the brightness, showing the clock when the oven is on standby position from 3 minutes. Also, the oven light is switched off during cooking. To view information on the display and switch the light on again, just press the button **3** or turn one of the knobs.

1. Turn the "Browse" knob to display "ECO".
2. Press **3** to access the setting (ON/OFF).
3. Turn the "Browse" knob to select the desired setting and confirm by pressing button **3**.
4. During a cooking function, if the Eco Mode is activated, the cavity lamp will be switched off after 1 minute of cooking and reactivated for each user interaction.

Acoustic signal

To activate or deactivate the acoustic signal, proceed as follows:

1. Turn the "Browse" knob to display "SOUND".
2. Press **3** to access the setting (ON/OFF).
3. Turn the "Browse" knob to select the desired setting and confirm by pressing button **3**.

Brightness

To change the display brightness, proceed as follows:

1. Turn the "Browse" knob to display "BRIGHTNESS".
2. Press button **3**: number 1 appears on the display.
3. Turn the "Browse" knob to increase or decrease brightness and confirm by pressing **3**.

AUTOMATIC OVEN CLEANING

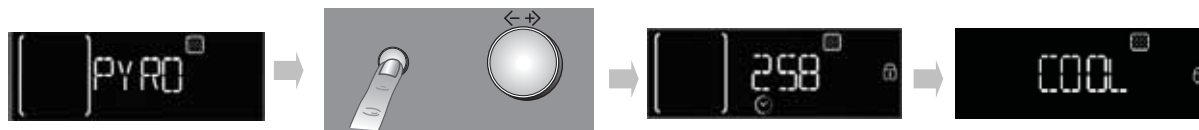

For the description of this function, see the chapter CLEANING and the functions table at pag. 14.





To activate the oven's automatic cleaning cycle (pyro-cleaning), proceed as follows:















1. Turn the "Functions" knob to symbol : the word PYRO appears on the display.
2. Press button  to confirm your choice and start the pyro-cleaning cycle.

To select ECO pyro-cleaning, turn the "Browse" knob: the word ECO appears bottom right on the display. Press button  to start the shorter programme.











During pyro-cleaning, the oven door is automatically locked and the symbol  appears on the display. The door remains locked at the end of the cleaning cycle: "COOL" appears on the display, indicating the oven is still cooling down. When the oven cools to a safe temperature, the symbol  switches off and the display shows "END".

NOTE: the automatic door lock control procedure fails to execute properly, the symbol  appears on the display. If, on the other hand, the door remains closed due to a fault in the locking system,  and "DOOR LATCHED" appear on the display. In this case, contact the After-sales Service.

OVEN FUNCTION DESCRIPTION TABLE

FUNCTION SELECTOR KNOB		
	OFF	To halt cooking and switch off the oven.
	LAMP	To switch the oven interior light on/off.
	 DEFROSTING	To speed up defrosting of food. Place food on the middle shelf. Leave food in its packaging in order to prevent it from drying out on the outside.
	 KEEP WARM	For keeping just-cooked food hot and crisp (e.g: meat, fried food or flans). Place food on the middle shelf. The function will not activate if the temperature in the oven is above 65°.
	 RISING	For optimal rising of sweet or savoury dough. To safeguard the quality of proving, the function will not activate if the temperature in the oven is above 40°C. Place the dough on the 2nd shelf. The oven does not have to be preheated.
	 ECO FORCED AIR	To cook stuffed roasts and meat in pieces on one shelf. This function uses discontinuous, delicate fan assistance, which prevents excessive drying of foods. In this ECO function the light remains off during cooking and can be temporarily switched on again by pressing the confirm button. In order to maximize energy efficiency, it is advisable not to open the door during cooking. It is advisable to use 3rd level. The oven does not have to be preheated.
	CONVENTIONAL	To cook any kind of dish on one shelf only. Use the 2nd shelf. Preheat the oven before placing food inside.
	CONVECTION BAKE	To cook meat and pies with liquid filling (savoury or sweet) on a single shelf. Use the 2nd shelf. Preheat the oven before cooking.
	FORCED AIR	To cook a variety of food requiring the same cooking temperature on two shelves at the same time (e.g fish, vegetables, cakes). This function can be used to cook different foods without odours being transferred from one food to another. Use the 2nd shelf to cook on one shelf only. To cook on two shelves, use the 1st and 3rd levels after preheating the oven.
	GRILL	To grill steak, kebabs and sausages; to cook vegetables au gratin and toast bread. Place food on the 4th shelf. When grilling meat, use the drip tray to collect the cooking juices. Position it on the 3rd shelf, adding approx. half a litre of water. The oven does not have to be preheated. During cooking the oven door must remain closed.
	TURBO GRILL	To roast large joints of meat (legs, roast beef, chickens). Position the food on the middle shelves. Use the drip tray to collect the cooking juices. Position it on the 1st/2nd shelf, adding approx. half a litre of water. The oven does not have to be preheated. During cooking the oven door must remain closed. With this function you can also use the turnspit, if provided.
	SETTINGS	For the display settings (language, time, brightness, volume of acoustic signal, energy saving function).
	BREAD/PIZZA	To bake different types and sizes of bread and pizza. This function contains two programmes with predefined settings. Simply indicate the values required (temperature and time) and the oven will manage the cooking cycle automatically. Place the dough on the 2nd shelf after preheating the oven.
	AUTOMATIC OVEN CLEANING	To burn off spatters produced during cooking with an extremely high temperature cycle (approx. 500°). Two auto-cleaning cycles are available: a complete cycle (PYRO) and a shorter cycle (ECO). The complete cycle is best used only in the case of very dirty ovens, while the shorter cycle should be used at regular intervals.
	FAST PREHEATING	To preheat the oven rapidly.















COOKING TABLE

Recipe	Function	Preheating	Shelf (from bottom)	Temperature (°C)	Time (min)	Accessories
Leavened cakes		Yes	2	160-180	30-90	Cake tin on wire shelf
		Yes	1-3	160-180	30-90	Shelf 3: cake tin on wire shelf Shelf 1: cake tin on wire shelf
Filled pies (cheesecake, strudel, apple pie)		Yes	2	160-200	30-85	Drip tray/ baking tray or cake tin on wire shelf
		Yes	1-3	160-200	35-90	Shelf 3: cake tin on wire shelf Shelf 1: cake tin on wire shelf
Biscuits/Tartlets		Yes	2	170-180	15-45	Drip tray / baking tray
		Yes	1-3	160-170	20-45	Shelf 3: grill Shelf 1: drip tray / baking tray
Choux buns		Yes	2	180-200	30-40	Drip tray / baking tray
		Yes	1-3	180-190	35-45	Shelf 3: oven tray on wire shelf Shelf 1: drip tray / baking tray
Meringues		Yes	2	90	110-150	Drip tray / baking tray
		Yes	1-3	90	130-150	Shelf 3: oven tray on wire shelf Shelf 1: drip tray / baking tray
Bread / Pizza / Focaccia		Yes	2	190-250	15-50	Drip tray / baking tray
		Yes	1-3	190-250	25-50	Shelf 3: oven tray on wire shelf Shelf 1: drip tray / baking tray
Bread		Yes	2	180-220	30-50	Drip-tray / baking tray or rack
Pizza		Yes	2	220-250	15-30	Drip-tray / baking tray
Frozen pizza		Yes	2	250	10-15	Shelf 2: drip tray / baking tray or wire shelf
		Yes	1-3	250	10-20	Shelf 3: oven tray on wire shelf Shelf 1: drip tray / baking tray
Savoury pies (vegetable pie, quiche)		Yes	2	180-190	35-45	Cake tin on wire shelf
		Yes	2-3	180-190	45-60	Shelf 3: cake tin on wire shelf Shelf 2: cake tin on wire shelf
Vols-au-vent / Puff pastry crackers		Yes	2	190-200	20-30	Drip tray / baking tray
		Yes	1-3	180-190	20-40	Shelf 3: oven tray on wire shelf Shelf 1: drip tray / baking tray
Lasagne / Baked pasta / Cannelloni / Flans		Yes	2	190-200	45-65	Drip tray or oven tray on wire shelf
Lamb / Veal / Beef / Pork 1 Kg		Yes	2	190-200	70-100	Drip tray or oven tray on wire shelf

Recipe	Function	Preheating	Shelf (from bottom)	Temperature (°C)	Time (min)	Accessories
Chicken / Rabbit / Duck 1 Kg		Yes	2	200-230	50-100	Drip tray or oven tray on wire shelf
Turkey / Goose 3 Kg		Yes	1/2	190-200	80-130	Drip tray or oven tray on wire shelf
Baked fish / en papillote (fillet, whole)		Yes	2	180-200	40-60	Drip tray or oven tray on wire shelf
Stuffed vegetables (tomatoes, courgettes, aubergines)		Yes	2	180-200	50-60	Oven tray on wire shelf
Toast		-	4	3 (high)	2-5	Wire shelf
Fish fillets / steaks		-	4	2 (medium)	20-35	Shelf 4: wire shelf (turn food halfway through cooking)
						Shelf 3: drip tray with water
Sausages / Kebabs / Spare ribs / Hamburgers		-	4	2-3 (medium - high)	15-40	Shelf 4: wire shelf (turn food halfway through cooking)
						Shelf 3: drip tray with water
Roast chicken 1-1.3 Kg		-	2	2 (medium)	50-65	Shelf 2: wire tray (turn food two thirds of the way through cooking)
				3 (high)	60-80	Shelf 1: drip tray with water
Roast Beef rare 1 Kg		-	2	2 (medium)	35-45	Oven tray on wire shelf (turn food two thirds of the way through cooking if necessary)
Leg of lamb / Shanks		-	2	2 (medium)	60-90	Drip tray or oven tray on wire shelf (turn food two thirds of the way through cooking if necessary)
Roast potatoes		-	2	2 (medium)	45-55	Drip-tray / baking tray (if necessary, turn food two thirds of the way through cooking)
Vegetable gratin		-	2	3 (high)	10-15	Oven tray on wire shelf
Lasagna & Meat		Yes	1-3	200	50-100*	Shelf 3: oven tray on wire shelf
						Shelf 1: drip tray or oven tray on wire shelf
Meat & Potatoes		Yes	1-3	200	45-100*	Shelf 3: oven tray on wire shelf
						Shelf 1: drip tray or oven tray on wire shelf
Fish & Vegetables		Yes	1-3	180	30-50*	Shelf 3: oven tray on wire shelf
						Shelf 1: drip tray or oven tray on wire shelf
Stuffed roasts		-	3	200	80-120*	Drip tray or oven tray on wire shelf
Meat pieces (rabbit, chicken, lamb)		-	3	200	50-100*	Drip tray or oven tray on wire shelf

*Cooking time is approximate. Food can be removed from the oven at different times depending on personal preference.

TESTED RECIPES (in compliance with IEC 60350-1:2011-12 and DIN 3360-12:07:07)

Recipe	Function	Preheating	Shelf (from the bottom)	Temp (°C)	Time (min)	Accessories and notes
IEC 60350-1:2011-12 § 7.5.2						
Shortbread		Yes	2	170	15-25	Drip tray / baking tray
		Yes	1-3	150	30-45	Shelf 3: baking tray Shelf 1: drip tray / baking tray
IEC 60350-1:2011-12 § 7.5.3						
Small cakes		Yes	3	170	20-30	Drip tray / baking tray
		Yes	1-3	160	25-35	Shelf 3: baking tray Shelf 1: drip tray / baking tray
IEC 60350-1:2011-12 § 7.6.1						
Fatless sponge cake**		Yes	2	170	30-40	Cake tin on wire shelf
		Yes	1-3	160	35-45	Shelf 3: cake tin on wire shelf Shelf 1: cake tin on wire shelf
IEC 60350-1:2011-12 § 7.6.2						
2 Apples pies		Yes	2	185	70-90	Cake tin on wire shelf
		Yes	1-3	175	70-90	Shelf 3: cake tin on wire shelf Shelf 1: cake tin on wire shelf
IEC 60350-1:2011-12 § 9.2						
Toast*		-	4	3 (high)	3-5	Wire shelf
IEC 60350-1:2011-12 § 9.3						
Burgers*		-	4	3 (high)	30-40	Shelf 4: wire shelf (turn food halfway through cooking) Shelf 3: drip tray with water
DIN 3360-12:07 § 6.5.2.3						
Apple cake, yeast tray cake		Yes	2	180	30-40	Drip tray / baking tray
		Yes	1-3	160	55-65	Shelf 3: baking tray Shelf 1: drip tray / baking tray
DIN 3360-12:07 § 6.6						
Roast pork		-	2	190	150-170	Drip tray
DIN 3360-12:07 annex C						
Flat cake		Yes	2	170	35-45	Drip tray / baking tray
		Yes	1-3	170	40-50	Shelf 3: baking tray Shelf 1: drip tray / baking tray

The cooking table advises the ideal function and cooking temperature to ensure the best results with all recipes. If you wish to cook on one shelf only using the fan-assisted function, place food on the second shelf and select the temperature recommended for the "FORCED AIR"  function when cooking on more than one shelf.

* When grilling food, leave a space of 3-4 cm at the front to facilitate removal from the oven.

The indications in the table are without use of the runners. Do the tests without the runners.

Energy efficiency class (according to EN 60350-1:2013-07)

To do the test, use the dedicated table.

RECOMMENDED USE AND TIPS

How to read the cooking table

The table indicates the best function to use for any given food, to be cooked on one or more shelves at the same time. Cooking times start from the moment food is placed in the oven, excluding pre-heating (where required). Cooking temperatures and times are purely for guidance and will depend on the amount of food and type of accessory used. Use the lowest recommended values to begin with and, if the food is not cooked enough, then move on to higher values. Use the accessories supplied and preferably dark coloured metal cake tins and oven trays. You can also use pans and accessories in pyrex or stoneware, but bear in mind that cooking times will be slightly longer. To obtain best results, carefully follow the advice given in the cooking table for the choice of accessories (supplied) to be placed on the various shelves.

Cooking different foods at the same time

Using the "FORCED AIR" function, you can cook different foods which require the same cooking temperature at the same time (for example: fish and vegetables), using different shelves. Remove the food which requires less cooking time and leave food which requires longer cooking time in the oven.

Desserts

- Cook delicate desserts with the conventional function on one shelf only. Use dark coloured metal cake tins and always position them on the wire shelf supplied. To cook on more than one shelf, select the forced air function and stagger the position of the cake tins on the shelves, aiding optimum circulation of the hot air.
- To check whether a raising cake is cooked, insert a wooden toothpick into the centre of the cake. If the toothpick comes out clean, the cake is ready.
- If using non-stick cake tins, do not butter the edges as the cake may not rise evenly around the edges.
- If the cake "sinks" during cooking, set a lower temperature the next time, perhaps reducing the amount of liquid in the mixture and mixing more gently.
- For sweets with moist fillings (cheesecake or fruit pies) use the "CONVECTION BAKE" function. If the base of the cake is soggy, lower the shelf and sprinkle the bottom of the cake with breadcrumbs or biscuit crumbs before adding the filling.

Meat

- Use any kind of oven tray or pyrex dish suited to the size of the piece of meat being cooked. For roast joints, it is best to add some stock to the bottom of the dish, basting the meat during cooking for added flavour. When the roast is ready, let it rest in the oven for another 10-15 minutes, or wrap it in aluminium foil.
- When you want to grill meat, choose cuts with an even thickness all over in order to achieve uniform cooking results. Very thick pieces of meat require longer cooking times. To prevent the meat from burning on the outside, lower the position of the wire shelf, keeping the food farther away from the grill. Turn the meat two thirds of the way through cooking.

To collect the cooking juices it is advisable to place a drip-tray with half a litre of water directly under the grill on which the meat is placed. Top-up when necessary.

Turnspit (only in some models)

Use this accessory to evenly roast large pieces of meat and poultry. Place the meat on the rotisserie rod, tying it with string if chicken, and check that it is secure before inserting the rod in the seat located on the front wall of the oven and resting it on the respective support. To prevent smoke and to collect cooking juices, it is advisable to place a drip-tray with half a litre of water on the first level. The rod has a plastic handle which must be removed before starting to cook, and used at the end of cooking to avoid burns when taking the food out of the oven.

Pizza

Lightly grease the trays to ensure the pizza has a crispy base. Scatter the mozzarella over the pizza two thirds of the way through cooking.

Rising function

It is always best to cover the dough with a damp cloth before placing it in the oven. Dough proving time with this function is reduced by approximately one third compared to proving at room temperature (20-25°C). Proving time for a 1 Kg batch of pizza dough is around one hour.



Printed in Italy
05/2010

5019 300 02957



Whirlpool® Registered trademark/TM Trademark of Whirlpool, USA

Free Manuals Download Website

<http://myh66.com>

<http://usermanuals.us>

<http://www.somanuals.com>

<http://www.4manuals.cc>

<http://www.manual-lib.com>

<http://www.404manual.com>

<http://www.luxmanual.com>

<http://aubethermostatmanual.com>

Golf course search by state

<http://golfingnear.com>

Email search by domain

<http://emailbydomain.com>

Auto manuals search

<http://auto.somanuals.com>

TV manuals search

<http://tv.somanuals.com>