



BUILT-IN HIGH SPEED MICROWAVE OVEN

Use & Care Guide

For questions about features, operation/performance parts, accessories or service, call: **1-800-253-1301**.

In Canada, call for assistance **1-800-461-5681**, for installation and service, call: **1-800-807-6777**

or visit our website at...

www.whirlpool.com or www.whirlpool.com/canada

Table of Contents.....2

**Models GSC278 YGSC278
GSC308 YGSC308**

TABLE OF CONTENTS

MICROWAVE OVEN SAFETY	3
Electrical Requirements	5
PARTS AND FEATURES	5
Grids	6
Crisper Pan and Handle.....	6
ELECTRONIC OVEN CONTROL	6
Displays	7
Add Minute, Start	7
Off/Cancel	7
Clock	7
Tones.....	7
Fahrenheit and Celsius.....	8
Timer.....	8
Control Lock.....	8
Number Codes.....	8
Help Prompts	8
HIGH SPEED COOKING	8
MICROWAVE OVEN USE	13
Food Characteristics	13
Cooking Guidelines	13
Cookware and Dinnerware	14
Aluminum Foil and Metal	14
Cooking Power.....	14
Cooking	15
Cooking in Stages.....	15
Crisper Pan Frying.....	15
Reheating	16
Defrost.....	16
Popcorn.....	17
Keeping Food Warm	18
Crisp	18
Broil	18
Convection Cooking.....	19
OVEN CARE	22
General Cleaning.....	22
TROUBLESHOOTING	22
ASSISTANCE OR SERVICE	23
In the U.S.A.	23
In Canada	23
WARRANTY	24



MICROWAVE OVEN SAFETY

Your safety and the safety of others are very important.

We have provided many important safety messages in this manual and on your appliance. Always read and obey all safety messages.



This is the safety alert symbol.

This symbol alerts you to potential hazards that can kill or hurt you and others.

All safety messages will follow the safety alert symbol and either the word "DANGER" or "WARNING." These words mean:

! DANGER

You can be killed or seriously injured if you don't immediately follow instructions.

! WARNING

You can be killed or seriously injured if you don't follow instructions.

All safety messages will tell you what the potential hazard is, tell you how to reduce the chance of injury, and tell you what can happen if the instructions are not followed.

IMPORTANT SAFETY INSTRUCTIONS

When using electrical appliances basic safety precautions should be followed, including the following:

WARNING: To reduce the risk of burns, electric shock, fire, injury to persons, or exposure to excessive microwave energy:

- Read all instructions before using the microwave oven.
- Read and follow the specific "PRECAUTIONS TO AVOID POSSIBLE EXPOSURE TO EXCESSIVE MICROWAVE ENERGY" found in this section.
- The microwave oven must be grounded. Connect only to properly grounded outlet. See "GROUNDING INSTRUCTIONS" found in this section.
- Install or locate the microwave oven only in accordance with the provided Installation Instructions.
- Some products such as whole eggs in the shell and sealed containers – for example, closed glass jars – may explode and should not be heated in the microwave oven.
- Use the microwave oven only for its intended use as described in this manual. Do not use corrosive chemicals or vapors in the microwave oven. This type of oven is specifically designed to heat, cook, or dry food. It is not designed for industrial or laboratory use.
- Oversized foods or oversized metal utensils should not be inserted in the microwave oven as they may create a fire or risk of electric shock.
- Do not clean with metal scouring pads. Pieces can burn off the pad and touch electrical parts involving a risk of electric shock.
- Do not store any materials, other than manufacturer's recommended accessories, in this oven when not in use.
- Do not operate the microwave oven if it has a damaged cord or plug, if it is not working properly, or if it has been damaged or dropped.
- Do not deep fry in oven. Microwavable utensils are not suitable and it is difficult to maintain appropriate deep frying temperatures.
- Do not use paper products when appliance is operated in the "PAN BROWN" mode.
- Do not cover racks or any other part of the oven with metal foil. This will cause overheating of the oven.
- As with any appliance, close supervision is necessary when used by children.
- The microwave oven should be serviced only by qualified service personnel. Contact nearest authorized service company for examination, repair, or adjustment.
- Do not cover or block any openings on the microwave oven.

SAVE THESE INSTRUCTIONS

IMPORTANT SAFETY INSTRUCTIONS

- Do not store the microwave oven outdoors. Do not use this product near water - for example, near a kitchen sink, in a wet basement, or near a swimming pool, and the like.
- See door surface cleaning instructions in the "Oven Care" section.
- To reduce the risk of fire in the oven cavity:
 - Do not overcook food. Carefully attend the microwave oven if paper, plastic, or other combustible materials are placed inside the oven to facilitate cooking.
 - Remove wire twist-ties from paper or plastic bags before placing bags in oven.
 - If materials inside the oven should ignite, keep oven door closed, turn oven off, and disconnect the power cord, or shut off power at the fuse or circuit breaker panel.
 - Do not use the cavity for storage purposes. Do not leave paper products, cooking utensils, or food in the cavity when not in use.

SAVE THESE INSTRUCTIONS

PRECAUTIONS TO AVOID POSSIBLE EXPOSURE TO EXCESSIVE MICROWAVE ENERGY...

- (a) Do not attempt to operate this oven with the door open since open-door operation can result in harmful exposure to microwave energy. It is important not to defeat or tamper with the safety interlocks.
- (b) Do not place any object between the oven front face and the door or allow soil or cleaner residue to accumulate on sealing surfaces.
- (c) Do not operate the oven if it is damaged. It is particularly important that the oven door close properly and that there is no damage to the:
 - (1) Door (bent),
 - (2) Hinges and latches (broken or loosened),
 - (3) Door seals and sealing surfaces.
- (d) The oven should not be adjusted or repaired by anyone except properly qualified service personnel.

Electrical Requirements

The microwave oven is connected to a 110-volt side of the 240-volt circuit required for the lower oven. If the incoming voltage to the microwave oven is less than 110 volts cooking times may be longer. Have a qualified electrician check your electrical system.

GROUNDING INSTRUCTIONS

■ For all cord connected appliances:

The microwave oven must be grounded. In the event of an electrical short circuit, grounding reduces the risk of electric shock by providing an escape wire for the electric current. The microwave oven is equipped with a cord having a grounding wire with a grounding plug. The plug must be plugged into an outlet that is properly installed and grounded.

WARNING: Improper use of the grounding plug can result in a risk of electric shock. Consult a qualified electrician or serviceman if the grounding instructions are not completely understood, or if doubt exists as to whether the microwave oven is properly grounded.

Do not use an extension cord. If the power supply cord is too short, have a qualified electrician or serviceman install an outlet near the microwave oven.

■ For a permanently connected appliance:

This appliance must be connected to a grounded, metallic, permanent wiring system, or an equipment grounding conductor should be run with the circuit conductors and connected to the equipment grounding terminal or lead on the appliance.

SAVE THESE INSTRUCTIONS

PARTS AND FEATURES

This manual covers different models. The oven you have purchased may have some or all of the parts and features listed. The location and appearance of the features shown here may not match your model.

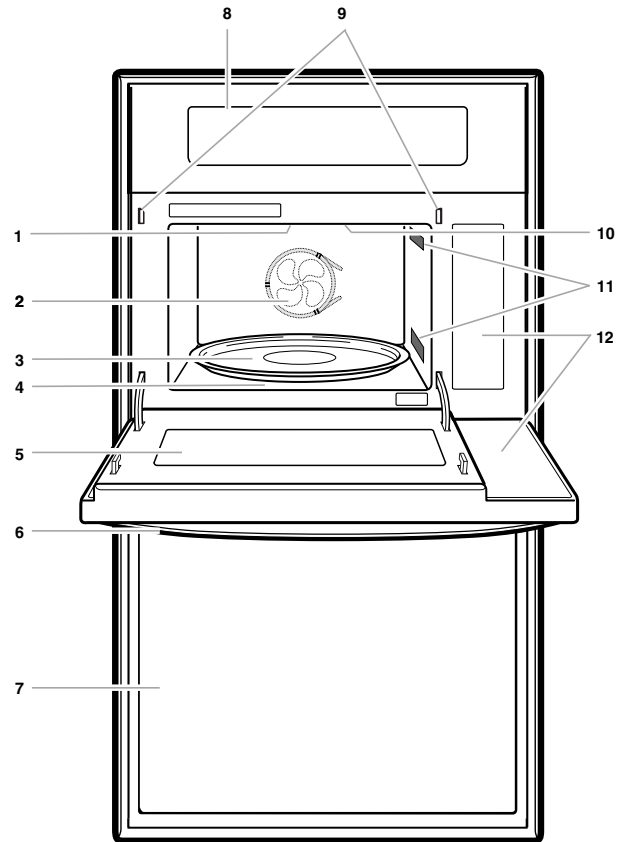

1. Light (inaccessible, in ceiling)
2. Convection Element and Fan (hidden behind back panel)
3. Turntable
4. Turntable Support (under turntable)
5. Metal Shielded Window
6. Door Handle
7. Lower Oven (on combination models, see separate Use and Care Guide)
8. Oven Control
9. Door Safety Lock System

10. Broil Element (hidden in ceiling)
11. Dual Microwave Emission
12. Cooking Guide Labels

Parts and Features not shown

Broiling Grid
Convection Grid
Crisper Pan and Handle

This unit must be connected to a 240-volt circuit.

Grids

- Grids will become hot. Always use oven mitts or pot holders when handling.
- Never allow the grids to touch the inside cavity walls, ceiling or floor.
- Always use the turntable.
- Never use another metal object with the grids.
- Two level cooking is not recommended.
- See “Assistance or Service” section to reorder.

Broiling Grid (long legs)

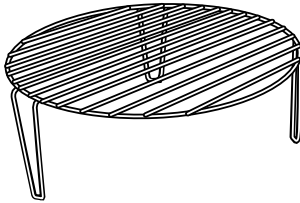

The broiling grid places food close to the broil element, making it ideal for fast browning of small amounts of food. Use for Broiling only.

Convection Grid (short legs)

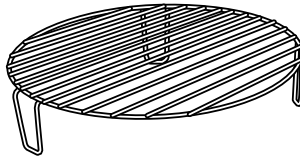

The convection grid provides optimal heat circulation for High Speed Cooking and Convection Cooking.

Crisper Pan and Handle

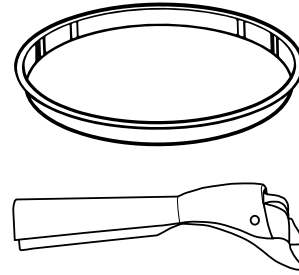

The crisper pan is ideal for rapidly browning and crisping the bottom of the food, such as cookies and pizza.

The material coating the bottom absorbs microwaves and transfers the heat to the pan and food. The crisper pan reaches 436°F (210°C) in approximately 3 minutes, at which time it stops absorbing microwaves and holds this optimal frying temperature.

- The crisper pan will become hot. Always use the handle and oven mitts or pot holders when handling.
- Never allow the crisper pan or handle to touch the inside cavity walls, ceiling or floor.
- Always use the turntable.
- Never use another metal object with the crisper pan.
- The crisper pan is designed specifically for this oven. Do not use it in any other oven.
- Use only wooden or plastic cooking utensils to help prevent scratches.
- See “Assistance or Service” section to reorder.

ELECTRONIC OVEN CONTROL

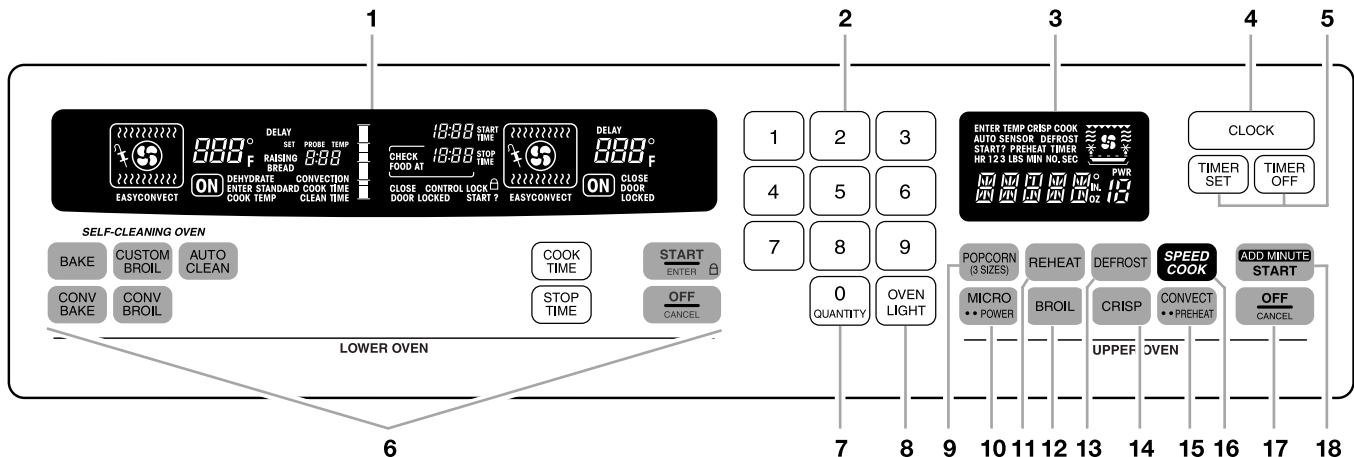

1. Lower Oven Display
2. Number Pads
3. Upper Oven Display
4. Clock
5. Timer
6. Lower Oven Selectors
(see separate Use and Care Guide)

7. Quantity
8. Lower Oven Light
9. Microwave Popcorn
10. Microwave Cooking Power
11. Microwave Reheating
12. Broiling

13. Microwave Defrosting
14. Crisping
15. Convection Cooking
16. High Speed Cooking
17. Upper Oven Off/Cancel
18. Upper Oven Start and Add Minute

Displays

When power is first supplied to the appliance, everything on both displays will light up for 5 seconds. Then, "PF id = 27" or "PF id = 30" will appear on the lower oven display. Touch OFF/CANCEL to clear display.

Any other time "PF id = 27" or "PF id = 30" appears, a power failure occurred. Touch OFF/CANCEL and reset the clock if needed.

Lower Oven Display

When the lower oven is in use, this display shows the lower oven temperature, heat source(s) and start time.

During lower oven Timed Cooking, this display also shows a vertical bar and minute time countdown and the stop time (if entered).

If "Err" appears on the display, an invalid pad was touched. Touch OFF/CANCEL and retry your entry.

When the lower oven is not in use, this display is blank.

Upper Oven Display

When the upper oven is in use, this display shows the upper oven heat source(s), cooking power, quantities, weights and/or help prompts.

If "RETRY" flashes on the display for one second, an invalid pad was touched. Retry your entry.

When the upper oven is not in use, this display shows the time of day or Timer countdown.

Add Minute, Start

Starting

The ADD MINUTE START pad begins any upper oven function except the Timer. If not touched within 5 seconds after touching a pad, "START?" will appear on the upper oven display as a reminder. If not touched within 5 minutes after touching a pad, the oven display will return to the time of day mode and the programmed function will be canceled. If cooking is interrupted, touching ADD MINUTE START will resume the preset cycle.

Adding Minutes

During High Speed Cooking, Crisping and Broiling, touching ADD MINUTE START while the oven is operating will add cook time in one minute increments.

During Microwave Cooking, touching ADD MINUTE START while the oven is operating, or at the end of a cycle, will add cook time at 100% cook power in one minute increments.

During Convection Cooking, touching ADD MINUTE START will not add minutes.

Off/Cancel

The upper oven OFF/CANCEL pad stops any upper oven function except for the Clock, Timer and Control Lock.

The oven will also turn off when the door is opened. When the door is opened, the element(s) and fan will turn off, but the upper oven light will remain on. Close the door and touch ADD MINUTE START to resume the cycle.

Clock

This is a 12-hour clock and does not show a.m. or p.m.

To Set:

Before setting, make sure the ovens, Timer and Timed Cooking are off.

1. Touch CLOCK.
2. Touch the number pads to set the time of day.
3. Touch CLOCK, START/ENTER or ADD MINUTE START.

To remove the time of day from the display: Touch and hold CLOCK for 5 seconds.

To return the time of day to the display: Touch CLOCK. The time should not have to be reset.

Tones

Tones are audible signals, indicating the following:

One tone

- Valid pad touch
- Oven is preheated
- Function has been entered

Three tones

- Invalid pad touch

Four tones

- End-of-cycle
- Reminder, repeating each minute after the end-of-cycle tones

All Tones

All of the above tones are preset on, but can be turned off.

To Turn Off/On: Touch and hold STOP TIME for 5 seconds. A tone will sound and "Snd off" will appear on the lower oven display for 3 seconds. Repeat to change back to "Snd on."

Tone Volume

The volume is preset at high, but can be changed to low.

To Change: Touch and hold the number pad "7" for 5 seconds. A tone will sound and "Snd Lo" will appear on the lower oven display for 3 seconds. Repeat to change back to "Snd HI."

REMINDER TONES

The Timer and Timed Cooking reminder tones are preset on, but can be turned off. Reminder tones do not include end-of-cycle tones. If "All Tones" have been turned off, the reminder tones cannot be independently turned on.

Timer

To Turn Tones Off/On: Touch and hold TIMER SET until a tone sounds. Repeat to turn back on.

Timed Cooking

To Turn Tones Off/On: Touch and hold COOK TIME until a tone sounds and the lower oven display returns to inactive mode (blank). Repeat to turn back on.

Fahrenheit and Celsius

The temperature is preset at Fahrenheit, but can be changed to Celsius.

To Change: Touch and hold CUSTOM BROIL for 5 seconds. A tone will sound and “C” will appear on the display. Repeat to change back to Fahrenheit. To remove, touch UPPER OFF, LOWER OFF or OFF/CANCEL.

Timer

The Timer can be set in minutes and seconds or hours and minutes, and counts down the set time. The Timer does not start or stop the oven.

To Set:

1. Touch TIMER SET.
Touch again to switch between MIN/SEC and HR/MIN.
If no action is taken after one minute, the upper oven display will return to the time of day mode.
 2. Touch the number pads to set length of time.
 3. Touch TIMER SET or ADD MINUTE START.
If not touched within 5 seconds, the display will return to the time of day mode and the programmed function will be canceled.
When the set time ends, if enabled, end-of-cycle tones will sound, then reminder tones will sound every minute.
 4. Touch TIMER OFF anytime to cancel the Timer and/or stop reminder tones.
Remember, touching the Off/Cancel pads will turn the respective oven off.
The time can be reset during the countdown by repeating the above steps.
-

Control Lock

The Control Lock shuts down the control panel pads to prevent unintended use of the ovens.

When the control is locked, only the CLOCK, TIMER SET and TIMER OFF pads will function.

The Control Lock is preset unlocked, but can be locked.

To Lock/Unlock Control: Before locking, make sure the ovens, Timer and Timed Cooking are off. Touch and hold START/ENTER until 3 tones sound and “CONTROL LOCK” and a picture of a lock appear on the lower oven display, about 3 seconds. Repeat to unlock and remove “CONTROL LOCK” from display.

Number Codes

The oven is preset with shortcut number codes for High Speed and Microwave Cooking. A number code includes one or more of the following; cooking power, cook time and food quantity or weight. See the code charts in the “High Speed Cooking,” “Reheating,” “Defrosting” and “Popcorn” sections for additional information.

Help Prompts

Help prompts are visible messages that appear on the upper oven display on combination oven models or the display on single oven models. Only Crisping and Broiling help prompts can be turned off.

Before turning help prompts on/off, the oven(s), Timer and, on combination oven models, the lower oven Timed Cooking must be off.

To Turn Off/On: Touch and hold the number pad “2” for 5 seconds. A tone will sound and either “HELP OFF” or “HELP ON” will flash on the upper oven display on combination oven models or the display on single oven models for 3 seconds. Repeat for desired option.

HIGH SPEED COOKING

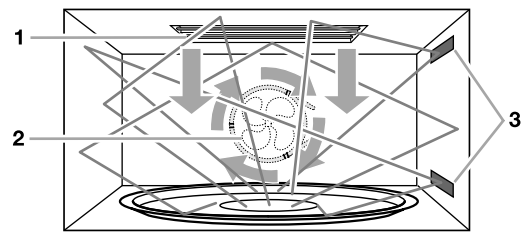

1. Broil element
2. Convection element and fan
3. Dual microwave emission

High Speed Cooking uses the broil element, convection element and fan and microwaves. All cycle on and off in intervals.

- Bakeware and the interior oven surfaces, including the door, will become hot.
- Always use an instant read meat thermometer to determine doneness of meat and poultry.
- Use non-metallic, oven proof glass, ceramic or plastic approved for conventional oven use.
- Covers are not necessary unless recommended in recipe. If recommended, use a casserole dish and its lid for optimal results.
- Do not use covers or containers made of foil, paper, waxed paper or plastic not recommended for use in a conventional oven.
- When roasting, meats and poultry will spatter. Plastic oven bags designed for conventional oven use can be used for easier cleanup. Follow manufacturer’s recommendations.
- When using the crisper pan or convection grid, place them directly on the turntable.
- Select tender cuts of meat for optimal cooking results.
- Arrange pieces of food in a single layer on the crisper pan or baking dish.

To Use:

Before High Speed Cooking, put food in the oven and close the door. Preheating is not necessary.

1. Touch SPEED COOK.
2. Touch the number pads to enter the food code from the chart.
If "WGT" or "QTY" appears on the upper oven display, touch the number pads to enter the quantity or weight from the chart or touch 0 QUANTITY to increase the weight in increments from the chart.
3. Touch ADD MINUTE START or wait 5 seconds for oven to turn on automatically.
The upper oven display will countdown the cook time.
When the cycle ends, "End" will appear in the upper oven display. If enabled, end-of-cycle tones will sound, then reminder tones will sound every minute.
4. Touch upper oven OFF/CANCEL or open the upper oven door when finished to clear the upper oven display.

HIGH SPEED COOKING CHART

Preset cooking times have been carefully determined, however individual tastes vary. If cooking results are not desirable after the cycle is over, code number 69 will add two additional minutes of cook time. It can be used multiple times. Also, check the food a few minutes before the cycle ends to help avoid overcooking.

FOOD	CODE	QUANTITY OR WEIGHT/ INSTRUCTIONS
BISCUITS AND ROLLS		
Biscuits, Large, Refrigerated	60	5 or 8 Arrange on crisper pan. Place on turntable.
Biscuits, Small, Refrigerated	59	6 or 12 Arrange on crisper pan. Place on turntable.
Cinnamon Rolls, Large, Refrigerated	62	No quantity entry required. Arrange on crisper pan. Place on turntable.
Cinnamon Rolls, Small, Refrigerated	61	5 or 8 Arrange on crisper pan. Place on turntable.
Orange Sweet Rolls, Refrigerated	63	No quantity entry required. Arrange on crisper pan. Place on turntable.
CASSEROLES		
Casserole, Freshly Made	27	4-10 cups (1-2.5 L) in 1 cup (250 mL) increments Place in casserole dish. Place convection grid on turntable, then casserole dish on grid.
Entrée, Frozen	29	10-45 oz (283 g-1.3 kg) in .5 oz (14 g) increments Loosen plastic film covering. Place convection grid on turntable, then entrée on grid.

FOOD	CODE	QUANTITY OR WEIGHT/ INSTRUCTIONS
Lasagna, Freshly Made	28	No quantity entry required. Use recipe that makes about 8 cups (2 L) and an 11x7 in. (28x18 cm) baking dish. Place convection grid on turntable, then baking dish on grid.
CONVENIENCE FOODS, FROZEN		
Chicken Breast Tenders	54	5 to 20 pieces Arrange on crisper pan. Place on turntable.
Chicken Nuggets	55	6 to 26 pieces Arrange on crisper pan. Place on turntable.
Chicken Wings, Buffalo Hot	49	.5-1.5 lbs (227-680 g) in .25 lb (113 g) increments Place in baking dish. Place convection grid on turntable, then baking dish on grid.
Dinners	43	6.5-16.5 oz (184-468 g) in .5 oz (14 g) increments Follow package instructions for venting of plastic film. Place convection grid on turntable, then dinner on grid.
Egg Rolls	47	1 to 8 pieces, 3 oz (85 g) each Place egg rolls directly on convection grid, then grid on turntable.
Egg Rolls, Mini	48	6 to 24 pieces Place egg rolls on crisper pan and crisper pan on turntable.
Entrée	29	10-45 oz (283 g-1.3 kg) in .5 oz (14 g) increments Loosen plastic film covering. Place convection grid on turntable, then entrée on grid.
Fish Portions, Battered	41	2 to 8 pieces, about 2 oz (57 g) each Arrange on crisper pan. Place on turntable.
Fish Sticks, Breaded	42	No quantity entry required. Use 4 to 18 pieces. Arrange on crisper pan. Place on turntable.
French Fries	44	3-12 oz (85-340 g) in 1 oz (28 g) increments Arrange on crisper pan. Place on turntable.

FOOD	CODE	QUANTITY OR WEIGHT/ INSTRUCTIONS
Onion Rings	57	4-16 oz (113-454 g) in 1 oz (28 g) increments Arrange on crisper pan. Place on turntable.
Pizza	40	6, 9 and 12 in. (15, 23 and 30 cm) diameter Arrange on crisper pan. Place on turntable.
Pizza Rolls, Mini	53	6 to 24 pieces Arrange on crisper pan. Place on turntable.
Potato Nuggets	46	3-12 oz (85-340 g) in 1 oz (28 g) increments Arrange on crisper pan. Place on turntable.
Potato Wedges	45	3-12 oz (85-340 g) in 1 oz (28 g) increments Arrange on crisper pan. Place on turntable.
DESSERTS		
Baked Apples	37	2 to 8 pieces Place in baking dish. Place convection grid on turntable, then baking dish on grid.
Bread Pudding	39	No quantity entry required. Place in 2 qt. (2 L) casserole dish. Place convection grid on turntable, then baking dish on grid.
Brownies	51	No quantity entry required. Use amount of batter for a 9x13 in. (23x33 cm) dish. Spray crisper pan with nonstick cooking spray and dust with dry bread crumbs. Spread batter into crisper pan. Place crisper pan on turntable.
Cake	50	No quantity entry required. Use amount of batter for a 9x13 in. (23x33 cm) dish. Spray crisper pan with nonstick cooking spray and dust with dry bread crumbs. Spread batter into crisper pan. Place crisper pan on turntable.
Cookies, Refrigerated Dough	64	No quantity entry required. Drop rounded teaspoonful (5 mL) of cookie dough on crisper pan. Pan will hold 12 cookies at a time. Place crisper pan on turntable.

FOOD	CODE	QUANTITY OR WEIGHT/ INSTRUCTIONS
Fruit Crisp	38	2 or 3 qts. (2 or 3 L) Place in baking dish. Place convection grid on turntable, then baking dish on grid.
MEATS		
Beef		
Beef Roast, Boneless	16	1.5-5 lbs (680-907 g) in .1 lb (45 g) increments Shake 1 T (15 mL) of flour in oven bag. Put roast in bag and close with plastic tie. Cut 6 small slits in top of bag. Place in baking dish. Place convection grid on turntable, then baking dish on grid.
Meatballs	20	No quantity entry required. Shape meat mixture into 20, 1½ in. (4 cm) meatballs. Place in baking dish. Place convection grid on turntable, then baking dish on grid.
Meat Loaf	18	1.5-2 lbs (680-907 g) of meat in .25 lb (113 g) increments Place meat loaf in a glass baking dish. Small in a 8.5x 4.5 in. (21.5x11 cm) dish. Large in a 9x5 in. (23x13 cm) dish. Place convection grid on turntable, then baking dish on grid.
Meat Loaf and 6 Potatoes	19	No quantity entry required. Place meat loaf made with 1½ lbs (680 g) of meat in an 8.5x4.5 in. (21.5x11 cm) baking dish. Place convection grid on turntable, then baking dish on grid. Prick skins of potatoes and arrange on grid around the meat loaf dish.
Swiss Steak	17	1-2 lbs (454 g-1 kg) in .25 lb (113 g) increments Follow recipe instructions, browning meat in a skillet. Place meat in baking dish. Add other recipe ingredients to dish. Place convection grid on turntable, then baking dish on grid.
Lamb		
Leg of Lamb, Boneless	26	1-2.5 lbs (454 g-1 kg) in .1 lb (45 g) increments Shake 1 T (15 mL) of flour in oven bag. Put leg of lamb in bag and close with plastic tie. Cut 6 small slits in top of bag. Place convection grid on turntable, then baking dish on grid.

FOOD	CODE	QUANTITY OR WEIGHT/ INSTRUCTIONS
Pork		
Ham, Fully Cooked, Boneless	25	1-4.5 lbs (454 g-2 kg) in .1 lb (45 g) increments Shake 1 T (15 mL) of flour in oven bag. Put ham and ½ cup (125 mL) water in bag. Close with plastic tie and cut 6 small slits in top of bag. Place in baking dish. Place convection grid on turntable, then baking dish on grid.
Pork Chops, Bone-in, ¾ in. (2 cm) thick	23	.4-1.5 lbs (181-680 g) in .1 lb (45 g) increments Place in baking dish. Place convection grid on turntable, then baking dish on grid.
Pork Chops, Boneless, ¾ in. (2 cm) thick	24	.3-1.6 lbs (136 g-2 kg) in .1 lb (45 g) increments Place in baking dish. Place convection grid on turntable, then baking dish on grid.
Pork Roast, Bone-in	21	2.5-4.5 lbs (1-2 kg) in .1 lb (45 g) increments Shake 1 T (15 mL) of flour in oven bag. Put pork roast in bag and close with plastic tie. Cut 6 small slits in top of bag. Place in baking dish. Place convection grid on turntable, then baking dish on grid.
Pork Roast, Boneless	22	1-5 lbs (454 g-2 kg) in .1 lb (45 g) increments Shake 1 T (15 mL) of flour in oven bag. Put pork roast in bag and close with plastic tie. Cut 6 small slits in top of bag. Place in baking dish. Place convection grid on turntable, then baking dish on grid.
POULTRY		
Chicken Breasts, Boneless, Skinless	12	.2-2 lbs (91-907 g) in .1 lb (45 g) increments Place in baking dish. Place convection grid on turntable, then baking dish on grid.
Chicken Breast Tenders, Frozen	54	5 to 20 pieces Arrange on crisper pan. Place on turntable.
Chicken Nuggets, Frozen	55	6 to 26 pieces Arrange on crisper pan. Place on turntable.
Chicken Pieces, Bone-in, with Skin	11	.5-2 lbs (227-907 g) in .1 lb (45 g) increments Place in baking dish. Place convection grid on turntable, then baking dish on grid.

FOOD	CODE	QUANTITY OR WEIGHT/ INSTRUCTIONS
Chicken Wings, Buffalo Hot, Frozen	49	.5-1.5 lbs (227-680 g) in .25 lb (113 g) increments Place in baking dish. Place convection grid on turntable, then baking dish on grid.
Chicken, Whole	10	3-5.5 lbs (1.3-2.5 kg) in .1 lb (45 g) increments Shake 1 T (15 mL) of flour in oven bag. Put chicken in bag and close with plastic tie. Cut 6 small slits in top of bag. Place in baking dish. Place convection grid on turntable, then baking dish on grid.
Cornish Hens	15	1.5-4.5 lbs (680 g-2 kg) in .1 lb (45 g) increments Shake 1 T (15 mL) of flour in oven bag. Put hen(s) in bag and close with plastic tie. Cut 6 small slits in top of bag. Place in baking dish. Place convection grid on turntable and baking dish on grid.
Turkey Breast, Bone-in	14	2-6.5 lbs (907 g-3 kg) in .1 lb (45 g) increments Shake 1 T (15 mL) of flour in oven bag. Put breast in bag and close with plastic tie. Cut 6 small slits in top of bag. Place in baking dish. Place convection grid on turntable, then baking dish on grid. If too tall, do not use grid.
Turkey, Whole, Unstuffed	13	10-12 lbs (4.5-5.5 kg) in .1 lb (45 g) increments Shake 1 T (15 mL) of flour in oven bag. Put turkey in bag and close with plastic tie. Cut 6 small slits in top of bag. Place in baking dish. Place convection grid on turntable, then baking dish on grid. If too tall, do not use grid.
SEAFOOD		
Fish Fillets, ¾ in. (2 cm) thick	67	.4-1.2 lbs (181-544 g) in .1 lb (45 g) increments Spray crisper pan with nonstick cooking spray. Place fish on crisper pan and crisper pan on turntable.
Fish Portions, Battered, Frozen, about 2 oz (57 g) each	41	2 to 8 pieces Arrange on crisper pan. Place on turntable.
Fish Steaks, 1 in. (2.5 cm) thick	68	.3-1.3 lbs (136-590 g) in .1 lb (45 g) increments Spray crisper pan with nonstick cooking spray. Place fish on crisper pan and crisper pan on turntable.

FOOD	CODE	QUANTITY OR WEIGHT/ INSTRUCTIONS
Fish Sticks, Breaded, Frozen	42	No quantity entry required. Use 4 to 18 pieces. Arrange on crisper pan. Place on turntable.
Shrimp, Raw, Shelled	52	.25-1 lbs (113-454 g) in .25 lb (113 g) increments Spray crisper pan with nonstick cooking spray. Place shrimp on crisper pan and crisper pan on turntable.
VEGETABLES		
Baked Potatoes, Large, White	30	1 to 8 potatoes Pierce skins. Place on convection grid and grid on turntable.
Baked Potatoes, Small- Medium, White	31	1 to 8 potatoes Pierce skins. Place on convection grid and grid on turntable.
Baked Sweet Potatoes, Large	32	1 to 6 potatoes Cut off thin, dried ends. Pierce skins. Place on convection grid and grid on turntable.
Baked Sweet Potatoes, Small- Medium	33	1 to 6 potatoes Cut off thin, dried ends. Pierce skins. Place on convection grid and grid on turntable.
French Fries, Frozen	44	3-12 oz (85-340 g) in 1 oz (28 g) increments Arrange on crisper pan. Place on turntable.
Onion Rings, Frozen	57	4-16 oz (113-454 g) in 1 oz (28 g) increments Arrange on crisper pan. Place on turntable.
Potato Mixes, Dry, Scalloped or Au Gratin	35	No quantity entry required. Follow package directions. Place convection grid on turntable, then baking dish on grid.
Potato Nuggets, Frozen	46	3-12 oz (85-340 g) in 1 oz (28 g) increments Arrange on crisper pan. Place on turntable.
Potato Skins	65	No quantity entry required. Bake 1½ lbs (680 g) potatoes. Scoop out insides leaving a ¾ in. (1 cm) shell. Brush both sides with butter. Place skins on crisper pan and crisper pan on turntable. With 1 minute of cooking time remaining, add toppings if desired.

FOOD	CODE	QUANTITY OR WEIGHT/ INSTRUCTIONS
Potato Wedges, Frozen	45	3-12 oz (85-340 g) in 1 oz (28 g) increments Arrange on crisper pan. Place on turntable.
Roasted Potatoes, Coating Mix, 3½ cups (875 mL) cubed potatoes	34	No quantity entry required. Follow coating mix package directions. Place in baking dish. Place convection grid on turntable, then baking dish on grid.
Roasted Vegetables	36	2-8 cups (500 mL-2 L) in 1 cup (250 mL) increments Cut fresh vegetables in bite-size pieces. Toss with olive or cooking oil and seasonings. Place in baking dish. Place convection grid on turntable, then baking dish on grid.
MISCELLANEOUS		
Cook 2 minutes longer	69	No quantity entry required. Gives 2 more minutes of cooking time. Use this code to finish cooking foods not done to your liking. May be used more than once.
Hot Dogs	56	2 to 10 pieces, .1 lb (45 g) each Arrange on crisper pan. Place on turntable.
Nachos	58	No quantity entry required. Use 8 oz (227 g) chips, salsa, cheese and other toppings to create your own nachos. Place in baking dish. Place convection grid on turntable, then baking dish on grid.
Pizza Reheat	66	1 to 4 pieces Place pizza slices on crisper pan and crisper pan on turntable.

MICROWAVE OVEN USE

A magnetron in the oven produces microwaves which reflect off the metal floor, walls and ceiling and pass through the turntable and appropriate cookware to the food. Microwaves are attracted to and absorbed by fat, sugar and water molecules in the food, causing them to move, producing friction and heat which cooks the food.

- Never lean on or allow children to swing on the oven door.
- Do not operate microwave oven when it is empty.
- Heated liquids can splash out during and after heating. Use of a wooden stir stick placed in the cup or bowl during heating may help to avoid this.
- The turntable must be in place and correct side up when oven is in use. Do not use if turntable is chipped or broken. See "Assistance or Service" section to reorder.
- Baby bottles and baby food jars should not be heated in the oven.
- Clothes, flowers, fruit, herbs, wood, gourds, paper, including brown paper bags and newspaper should not be dried in the oven.
- Do not use the microwave oven for canning, sterilizing or deep frying. The oven cannot maintain appropriate temperatures.
- Paraffin wax will not melt in the oven because it does not absorb microwaves.
- Use oven mitts or pot holders when removing containers from oven.
- Do not overcook potatoes. At the end of the recommended cook time, potatoes should be slightly firm. Let potatoes stand for five minutes. They will finish cooking while standing.
- Do not cook or reheat whole eggs or eggs inside the shell. Steam buildup in whole eggs may cause them to burst. Cover poached eggs and allow a standing time.

Food Characteristics

When microwave cooking, the amount, size and shape, starting temperature, composition and density of the food affect cooking results.

Amount of Food

The more food heated at once the longer the cook time. Check for doneness and add small increments of time if necessary.

Size and Shape

Smaller pieces of food will cook more quickly than larger pieces and uniformly shaped foods cook more evenly than irregularly shaped food.

Starting Temperature

Room temperature foods will heat faster than refrigerated foods and refrigerated foods will heat faster than frozen foods.

Composition and Density

Foods high in fat and sugar will reach a higher temperature and heat faster than other foods. Heavy, dense foods, such as meat and potatoes, require a longer cook time than the same size of a light, porous food, such as cake.

Cooking Guidelines

Covering

Covering food helps retain moisture, shorten cook time and reduce spattering. Use the lid supplied with cookware. If lid is not available, wax paper, paper towels or plastic wrap approved for microwaves may be used. Plastic wrap should be turned back at one corner to provide an opening to vent steam.

Stirring and Turning

Stirring and turning redistributes heat evenly to avoid overcooking the outer edges of food. Stir from outside to center. If possible, turn food over from bottom to top.

Arranging

If heating irregularly shaped or different sized foods, the thinner parts and smaller sizes should be arranged toward the center. If cooking several items of the same size and shape, place them in a ring pattern, leaving the center of the ring empty.

Piercing

Before heating, use a fork or small knife to pierce or prick foods that have a skin or membrane, such as potatoes, egg yolks, chicken livers, hot dogs, and sausage. Prick in several places to allow steam to vent.

Shielding

Use small, flat pieces of aluminum foil to shield the thin pieces of irregularly shaped foods, bones and foods such as chicken wings, leg tips and fish tail. See "Aluminum Foil and Metal" first.

Standing Time

Food will continue to cook by the natural conduction of heat even after the microwave cycle ends. The length of standing time depends on the volume and density of the food.

Cookware and Dinnerware

Cookware and dinnerware must fit on the turntable. Always use oven mitts or pot holders when handling because any dish may become hot from heat transferred from the food. Do not use cookware and dinnerware with gold or silver trim. Use the following chart as a guide, then test before using.

MATERIAL	RECOMMENDATIONS
Aluminum Foil, Metal	See "Aluminum Foil and Metal" section.
Browning Dish	Bottom must be at least $\frac{3}{16}$ in. (5 mm) above the turntable. Follow manufacturer's recommendations.
Ceramic Glass, Glass	Acceptable for use.
China, Earthenware	Follow manufacturer's recommendations.
Melamine	Follow manufacturer's recommendations.
Paper Towels, Dinnerware, Napkins	Use non-recycled and those approved by the manufacturer for microwave oven use.
Plastic Wraps, Bags, Covers, Dinnerware, Containers	Use those approved by the manufacturer for microwave oven use.
Pottery and Clay	Follow manufacturer's recommendations.
Styrofoam®	Do not use in oven.
Straw, Wicker, Wooden Containers	Do not use in oven.
Wax Paper	Acceptable for use.

To Test Cookware or Dinnerware for Microwave Use:

- Put cookware or dinnerware in oven with 1 cup (250 mL) of water beside it.
- Cook at 100% cooking power for 1 minute.

Do not use cookware or dinnerware if it becomes hot and the water stays cool.

Aluminum Foil and Metal

Always use oven mitts or pot holders when removing dishes from the microwave oven.

Aluminum foil and some metal can be used in the oven. If not used properly, arcing (a blue flash of light) can occur and cause damage to the oven.

OK for Use

Racks and bakeware supplied with the oven, aluminum foil for shielding, and approved meat thermometers may be used with the following guidelines:

- Never allow aluminum foil or metal to touch the inside cavity walls, ceiling or floor.

- Always use the turntable.
- Never allow contact with another metal object during cooking.

Do Not Use

Metal cookware and bakeware, gold, silver, pewter, non-approved meat thermometers, skewers, twist ties, foil liners such as sandwich wrappers, staples and objects with gold or silver trim or a metallic glaze should not be used in the oven.

Cooking Power

Many recipes for microwave cooking specify which cooking power to use by percent, name or number. For example, 70%=7=Medium-High.

Use the following chart as a general guide for the suggested cooking power of specific foods.

PERCENT/ NAME	NUMBER	USE
100%, High (default setting)	10	Quick heating convenience foods and foods with high water content, such as soups, beverages and most vegetables.
90%	9	Cooking small tender pieces of meat, ground meat, poultry pieces and fish fillets. Heating cream soups.
80%	8	Heating rice, pasta or casseroles. Cooking and heating foods that need a cook power lower than high. For example, whole fish and meat loaf.
70%, Medium-High	7	Reheating a single serving of food.
60%	6	Cooking sensitive foods such as cheese and egg dishes, pudding and custards. Cooking non-stirrable casseroles, such as lasagna.
50%, Medium	5	Cooking ham, whole poultry and pot roasts. Simmering stews.
40%	4	Melting chocolate. Heating bread, rolls and pastries.
30%, Medium-Low, Defrost	3	Defrosting bread, fish, meats, poultry and precooked foods.
20%	2	Softening butter, cheese, and ice cream.
10%, Low	1	Taking chill out of fruit.

To Set a Cooking Power other than 100%:

1. Touch the number pads to set a length of time to cook.
2. Touch MICRO •• POWER.
3. Touch the number pad using the Cooking Power chart
4. Touch ADD MINUTE START.

The display will count down the cook time.

When the cycle ends, "End" will appear in the display, 4 end-of-cycle tones will sound, and then reminder tones will sound every minute.

5. Touch upper oven OFF/CANCEL or open the door to clear the display and/or stop reminder tones.

Cooking

To Use:

1. Touch the number pads to set a length of time to cook.
Touch MICRO •• POWER to set a cooking power other than 100%. Touch the number pad(s) using the Cooking Power chart.
2. Touch ADD MINUTE START.
The display will count down the cook time.
When the cycle ends, "End" will appear in the display, 4 end-of-cycle tones will sound, and then reminder tones will sound every minute.
3. Touch upper oven OFF/CANCEL or open the door to clear the display and/or stop reminder tones.

The cook time and cooking power can be changed after touching ADD MINUTE START without interrupting cooking.

To Change Cook Time: Touch MICRO •• POWER once. Enter the new cook time within 5 seconds. Touch ADD MINUTE START, or wait 5 seconds and the change will be entered automatically.

To Change Cooking Power: Touch MICRO •• POWER twice. Enter the new cook power within 5 seconds. Touch ADD MINUTE START, or wait 5 seconds and the change will be entered automatically.

Cooking in Stages

The microwave oven can be set to cook at different cooking powers for various lengths of time, up to three stages.

To Cook in Stages:

1. Touch the number pads to set a length of cook time for the first stage.
2. Touch MICRO •• POWER and then enter a cook power (if other than 100%) from the Cook Power Chart.
3. Touch MICRO •• POWER to start programming next stage.
4. Repeat the above steps for second and third stage programming.
The numbers "1," "2" and/or "3" will appear in the upper oven display during programming.
5. Touch ADD MINUTE START when cook times and cook powers have been entered.
The upper oven display will count down each of the cook times. The numbers "1," "2" or "3" will appear in the display during their respective stages.

When the cycle ends, "End" will appear in the display, 4 end-of-cycle tones will sound, and then reminder tones will sound every minute.

Cook time may be changed during any cycling stage by touching MICRO •• POWER once, and then entering the new time within 5 seconds. Time may be added in one-minute increments by touching ADD MINUTE START during the cycling stage.

6. Touch upper oven OFF/CANCEL or open the door to clear the display and/or stop reminder tones.

Crisper Pan Frying

When the crisper pan is used with microwaves, it is like a frying pan or griddle, ideal for French toast, burgers, eggs, stir-frying and sautéing. See "Crisper Pan and Handle" section first before using.

To Use:

Before crisper pan frying, brush crisper pan with ½ tsp (3 mL) of oil or spray with nonstick cooking spray. Arrange food on crisper pan. Place pan on turntable.

1. Touch the number pads to set a length of time to cook.

2. Touch ADD MINUTE START.

The upper oven display will countdown the cook time.

When the cycle ends, "End" will appear in the upper oven display. If enabled, end-of-cycle tones will sound, then reminder tones will sound every minute.

3. Touch upper oven OFF/CANCEL or open the upper oven door to clear the display and/or stop reminder tones.

CRISPER PAN FRYING CHART

Times are approximate and may be adjusted for individual tastes.

FOOD	COOKTIME	INSTRUCTIONS
Bacon, Canadian 2¼ in. (6 cm) thick slices	1 minute	Turn slices over on crisper pan after cooking.
Eggs, scrambled 2 4	45 sec. to 1 min. 2 to 3 minutes	Mix 1 tablespoon of water per egg and pour into preheated pan.
French Toast, Pancakes, Waffles, 4 Frozen	3 to 4 minutes	Turn halfway through cooking.
Ground Beef, 1 lb. (454 g)	6 to 7 minutes	Crumble meat before cooking. Stir halfway through cooking. Make sure no pink center.
Ground Beef Patties, two 4 oz. (113 g) patties	Side1: 2 minutes Side 2: 2 to 4 min.	Cook completely, no pink center.
Pizza Dough, uncooked 9 and 12 in. (23 and 30 cm)	4 to 5 minutes	Sprinkle with corn meal. Press dough into pan. After precooking dough, add sauce and toppings.
Vegetables, stir-fry, 2 cups (500 mL)	4 minutes	Cut vegetables in equal sizes. Stir after 2 minutes.

Reheating

Times and cooking powers have been preset for reheating 8 food types. Use the following chart as a guide.

FOOD	CODE	QUANTITY
Dinner Plate	1	1 to 2 servings
Bread	2	1 to 6 slices
Meats	3	1 to 6 servings
*Cheese Dip	4	1 to 3 cups (250 - 750 mL)
*Soup	5	1 to 4 cups (250 mL-1 L)
*Sauce	6	1 to 3 cups (250 - 750 mL)
Pizza	7	1 to 2 servings
Beverage	8	Serving Temperature
1 Coffee		1 Warm
2 Tea		2 Hot
3 Hot Chocolate		3 Very Hot

* Four tones will sound at the midpoint of the reheat cycle, and "STIR" will appear in the display. Stir food if desired, close door, and touch ADD MINUTE START.

To Reheat Foods:

- Touch REHEAT.
Touch number pad to select food type from the Reheat chart.
or
Touch REHEAT repeatedly to scan and select food settings. For example, to select the Bread setting, REHEAT must be touched twice.
- Touch number pads to enter quantity (in servings, strips or cups)
or
Touch QUANTITY (number pad "0") to scan and select quantities. For example, to select the quantity of 2 servings, QUANTITY must be touched twice.
- Touch ADD MINUTE START or wait 5 seconds and the microwave oven will start automatically.
The upper oven display will count down the reheat time.
When the cycle ends, "End" will appear in the display, 4 end-of-cycle tones will sound, and then reminder tones will sound every minute.
- Touch upper oven OFF/CANCEL or open the door to clear the display and/or stop reminder tones.

To Reheat Beverages:

- Touch REHEAT.
- Touch number pad "8"
or
Touch REHEAT repeatedly until the Beverages setting, "BEVRG-8" is reached.

- Touch number pad from chart to select beverage type.
- Touch number pad from chart to select serving temperature.
- Touch ADD MINUTE START or wait 5 seconds and the microwave oven will start automatically.

The upper oven display will count down the reheat time.

When the cycle ends, "End" will appear in the display, 4 end-of-cycle tones will sound, and then reminder tones will sound every minute.

IMPORTANT: Heated liquids can splash out during and after heating. A wooden stir stick placed in the cup or bowl during heating may help avoid this.

- Touch upper oven OFF/CANCEL or open the door to clear the display and/or stop reminder tones.

For more information on reheating different foods using the manual microwave function, see "MICROWAVE REHEAT CHART" at the end of the "MICROWAVE OVEN USE" section.

Defrost

The Defrost feature can be used, or the microwave oven can be manually set to defrost by using 30% cook power.

- Food should be 0°F (-18°C) or colder at defrosting for optimal results.
- Unwrap foods and remove lids (from fruit juice) before defrosting.
- Shallow packages will defrost more quickly than deep blocks.
- Separate food pieces as soon as possible during or at the end-of-cycle for more even defrosting.
- Foods left outside the freezer for more than 20 minutes or frozen ready-made food should not be defrosted using the Custom Defrost feature, but should be defrosted manually.
- Use small pieces of aluminum foil to shield parts of food such as chicken wings, leg tips and fish tails. See "Aluminum Foil and Metal" first.

DEFROST CHART

The Custom Defrost system has six categories: Meat, Poultry, Fish, Bagel, Fruit Juice, and Roll/Muffin. Use the following chart as a guide.

FOOD SETTING	CODE	WEIGHT OR QUANTITY
*Meats	1	.1 to 6.6 lbs (45 g to 3 kg)
*Poultry	2	.1 to 6.6 lbs (45 g to 3 kg)
*Fish	3	.1 to 4.4 lbs (45 g to 1.34 kg)
**Bagel	4	1 to 6 pieces
Fruit Juice	5	6, 12 or 16 oz (170, 340 or 454 g)
Roll/Muffin	6	1 to 6 pieces

*See Preparation chart at end of "Defrost" section for cuts, sizes, and instructions.

**Bagel quantity settings 1 and 2 may appear to have longer defrost times than necessary, however, longer times use less cooking power.

To use Defrost:

1. Touch DEFROST.
2. Touch the number pad from the Defrost chart to select food
or
Touch DEFROST repeatedly to scroll through foods.
3. Touch number pads from the Defrost chart to select the weight or quantity
or
Touch QUANTITY (number pad "0") repeatedly to select quantity.
4. Touch ADD MINUTE START or wait 5 seconds and the microwave oven will start automatically.
The display will count down the defrost time. For better results, a preset standing time is included in the defrosting time. This may make the defrosting time seem longer than expected.
When the cycle ends, "End" will appear in the display, 4 end-of-cycle tones will sound, and then reminder tones will sound every minute.
5. Touch upper oven OFF/CANCEL or open the door to clear the display and/or stop reminder tones.

The cook time can be changed during the defrosting cycle without interrupting cooking.

To Change Defrost Time: Touch MICRO •• POWER repeatedly to scroll through "MORE," "LESS" or "NORML" time.

MEAT, POULTRY AND FISH DEFROST PREPARATION

Use the following chart as a guide when defrosting meat, poultry, or fish. When setting the Custom Defrost cycle, the net weight must be entered in pounds and tenths of pounds.

MEAT

<i>Beef:</i> ground, steaks, roast, stew	The narrow or fatty areas of irregular shaped cuts should be shielded with foil before defrosting.
<i>Lamb:</i> stew and chops	Do not defrost less than ¼ lb (113 g) or two 4 oz (113 g) patties.
<i>Pork:</i> chops, ribs, roasts, sausage	Place all meats in microwavable baking dish.

POULTRY

<i>Chicken:</i> whole and cut up	Place in microwavable baking dish, chicken breast-side up.
<i>Cornish hens</i>	Remove giblets from whole chicken.

FISH

<i>Fillets, Steaks, Whole, Shellfish</i>	Place in microwavable baking dish.
--	------------------------------------

Popcorn

- Do not use regular paper bags or glass utensils.
- Pop only one package of popcorn at a time.
- Follow manufacturer's instructions when using a microwave popcorn popper.
- Listen for popping to slow to 1 pop every 1 or 2 seconds. Do not repop unpopped kernels.
- Use fresh bags of popcorn for optimal results.
- Cooking results may vary by brand and fat content.

Popping time has been preset based on commercially packaged microwave popcorn. The oven is preset for the 3.5 oz (99 g) size, but can be changed. Use the following chart as a guide.

BAG SIZE	CODE	TOUCH PAD
3.5 oz (99 g)	1	Once
3.0 oz (85 g)	2	Twice
1.75 oz (50 g)	3	Three times

To Pop Popcorn:

1. Touch POPCORN (3 SIZES).
The microwave oven will be set to automatically begin the pop setting for the 3.5 oz (99 g) bag size.
Touch POPCORN (3 SIZES) repeatedly to scan and select bag size
or
Touch number pad from chart to manually select bag size.
2. Touch ADD MINUTE START or wait 5 seconds for the popping to begin automatically.
The upper oven display will count down the popping time.
Time may be added to popping time by touching ADD MINUTE START during or after popping.
When the popcorn cycle ends, "End" will appear in the display, 4 end-of-cycle tones will sound, and then reminder tones will sound every minute.
3. Touch upper oven OFF/CANCEL or open the door to clear the display and/or stop reminder tones.

Keeping Food Warm

! WARNING

Food Poisoning Hazard

Do not let food sit in oven more than one hour before or after cooking.

Doing so can result in food poisoning or sickness.

Hot cooked food can be kept warm in the microwave oven.

Foods that are cooked covered and complete meals on dinner plates should be covered while being kept warm. Pastry items such as pies and turnovers should be uncovered while being kept warm.

To Keep Food Warm:

1. Touch number pads to set length of warm time.
2. Touch MICRO •• POWER.
3. Touch number pad "1" to set cook power at 10%.
4. Touch ADD MINUTE START.

The upper oven display will count down the warm time.

When the cycle ends, "End" will appear in the display, 4 end-of-cycle tones will sound, and then reminder tones will sound every minute.

5. Touch upper oven OFF/CANCEL or open the door to clear the display.

To program keep-warm at the end of a cooking cycle, set the time and the cook power (10%) as the last cooking stage. See "Cooking in Stages" section.

Crisp

The Crisp feature uses the broil element and microwaves to crisp and brown foods. Crisp can be used to saute meats and vegetables, pan-fry bacon and eggs, and to crisp and brown pizza and cheese sandwiches. Always use the crisper pan. See the "Crisper Pan and Handle" section before using.

To Crisp:

Before Crisping, brush crisper pan with ½ tsp (3 mL) of oil or spray with nonstick cooking spray. Arrange food on crisper pan, and place pan on turntable.

1. Touch CRISP.
2. Touch the number pads to enter a length of time to cook in minutes and seconds. The time can be set up to 90 minutes.
3. Touch ADD MINUTE START.

The upper oven display will count down the crisp time.

Time may be added during cooking by touching ADD MINUTE START.

When the cycle ends, "End" will appear in the display, 4 end-of-cycle tones will sound, and then reminder tones will sound every minute.

4. Touch upper oven OFF/CANCEL or open the door to clear the display.

CRISPING CHART

Times are approximate and may be adjusted for individual tastes.

FOOD	COOK TIME	PREPARATION
Pizza, refrigerated or fresh		Sprinkle crisper pan with corn meal. Add additional time for thick crust and reduce time for thin crust.
12 in. (30 cm)	9 minutes	
9 in. (23 cm)	7 minutes	
Puff Pastry Fruit Turnovers, 4 Frozen	10 to 12 minutes	
Turkey Breast, boneless	10 to 12 minutes per 1 lb (454 g)	Place turkey in center of crisper pan. Internal temperature should be 170°F (77°C).

Broil

The Broil feature uses the broil element to cook and brown 1 to 4 small pieces of food at a time. Always use the broiling grid. The Crisper Pan may be used with the Broil function to catch drippings from the food. See "Grids" section before using.

- Avoid opening the door often.
- For even browning, turn food over halfway through cooking.

To Broil:

Before broiling, remove turntable hub. See "Parts and Features" for location. Replace turntable in oven. Turntable must be in place during broiling, but will not rotate. Then preheat broil element for 2 to 3 minutes. Place all food on half of broiling grid. Place grid on turntable, and position it so that the food is directly under the broil element.

1. Touch BROIL.
2. Touch the number pads to enter a length of time to cook in minutes and seconds.
3. Touch ADD MINUTE START.

The upper oven display will count down the broil time.

Time may be added during cooking by touching ADD MINUTE START.

When the cycle ends, "End" will appear in the display, 4 end-of-cycle tones will sound, and then reminder tones will sound every minute.

4. Touch upper oven OFF/CANCEL or open the door to clear the display.

BROILING CHART

Times are approximate and may be adjusted for individual tastes.

FOOD	COOK TIME	PREPARATION
Garlic Toast or Open Face Sandwiches	2 to 3 minutes	
Steaks, 2 top sirloin, ¾ in. (2 cm) thick, 8 oz. (227g) portions	Medium doneness Side 1: 10 minutes Side 2: 8 minutes	Trim excess fat and score edges. Let stand 1 minute before serving.

Convection Cooking

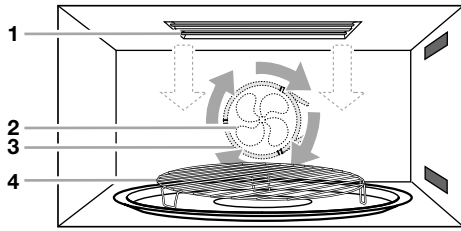

1. Broil element
2. Convection fan
3. Convection element
(on some models)
4. Convection grid

Convection Cooking uses the convection element (on some models) and the fan. The Broil element will also cycle on and off. Hot air is circulated throughout the oven cavity by the fan. The constantly moving air surrounds the food to heat the outer portion quickly.

The Convection function may be used to cook small amounts of food on a single rack.

- Always use the Convection Grid.
- Do not cover Turntable or Convection Grid with aluminum foil.
- Do not use light plastic containers, plastic wrap or paper products. All heat proof cookware or metal utensils can be used in convection cooking, but metal utensils cannot be used in microwave cooking. Round pizza pans are excellent for convection cooking.
- Use convection cooking for items such as souffles, breads, cookies, angel food cakes, pizza, and most meats and fish.
- No special techniques are needed to adapt standard oven recipes to convection cooking, although some temperatures might need to be reduced, and some cooking times might need to be shortened.
- This oven may be preheated in the same way that standard oven is preheated. (Most recipes for baked goods call for preheating.)

To Convection Cook with Preheat:

1. Position convection grid on turntable in microwave oven and close the door.
2. Touch CONVECT ●● PREHEAT twice.
"PREHEAT" will appear in the upper oven display.
Touch the number pads to set a temperature other than 325°F (162°C). The cook temperature setting may be changed as desired from 170°F to 450°F (77°C to 232°C).
Celsius temperatures below 100°C must have a "0" at the beginning of their entries. For example, 77°C must be entered as 0-7-7.
3. Touch ADD MINUTE START.
The upper oven display will show the "TIME" prompt.
4. Touch number pads to enter length of time to cook, in hours and minutes, up to 4 hours.

5. Touch ADD MINUTE START.

"Lo" will appear in the upper oven display until the temperature reaches 170°F (77°C). When that temperature is reached, the display will show the preheating temperature in 5°F (-15°C) increments until the set cooking temperature is reached.

When preheating is complete, one tone will sound, and the display will show the set cook time.

6. Place food or bakeware on convection grid and close the door.

7. Touch ADD MINUTE START.

The upper oven display will count down the cook time.

Each time the door is opened during cooking, the ADD MINUTE START pad must be touched to restart cooking.

When the cycle ends, "End" will appear in the display, 4 end-of-cycle tones will sound, and then reminder tones will sound every minute.

8. Touch upper oven OFF/CANCEL or open the door to clear the display.

To Convection Cook without Preheat:

1. Position convection grid on turntable in microwave oven, place food or bakeware on convection grid, and close the door.

2. Touch CONVECT ●● PREHEAT once.

Touch the number pads to set a temperature other than 325°F (162°C). The cook temperature setting may be changed as desired from 170°F to 450°F (77°C to 232°C).

Celsius temperatures below 100°C must have a "0" at the beginning of their entries. For example, 77°C must be entered as 0-7-7.

3. Touch ADD MINUTE START.

The upper oven display will show the "TIME" prompt.

4. Touch number pads to enter length of time to cook, in hours and minutes, up to 4 hours.

5. Touch ADD MINUTE START.

The upper oven display will count down the cook time.

Each time the door is opened during cooking, the ADD MINUTE START pad must be touched to restart cooking.

When the cycle ends, "End" will appear in the display, 4 end-of-cycle tones will sound, and then reminder tones will sound every minute.

6. Touch upper oven OFF/CANCEL or open the door to clear the display.

MICROWAVE COOK CHART

These times are approximate and may need to be adjusted to suit individual taste.

FOOD	COOK TIME	COOK POWER
Meats, Poultry, Fish, Seafood		
Bacon (per slice)	45 sec to 1 min 15 sec per slice	100%
Ground Beef for Casseroles (1 lb [.45 kg])	4 to 6 min	100%
Ground Beef Patties (2)	1st side 2 min, 2nd side 1½ to 2½ min	100%
Ground Beef Patties (4)	1st side 2½ min, 2nd side 2 to 3 min	100%
Meat Loaf (1½ lbs [.7 kg])	13 to 19 min	70%
Chicken Pieces Internal temperature should be 185°F (85°C) after standing.	6 to 9 min/lb (454 g)	100%
Turkey Breast Internal temperature should be 185°F (85°C) after standing.	5 min, then 8 to 12 mins	100%, 70%
Fish Fillets (1 lb [.45 kg])	5 to 6 min	100%
Scallops and Shrimp (1 lb [.45 kg])	3½ to 5½ min	100%
Vegetables		
Beans, Green or Yellow (1 lb [.45 kg])	6 to 12 min	100%
Broccoli (1 lb [.45 kg])	6 to 10 min	100%
Carrots (1 lb [.45 kg])	8 to 12 min	100%
Cauliflower (medium head)	6 to 9 min	100%
Corn on the Cob (2)	4 to 9 min	100%
Corn on the Cob (4)	6 to 16 min	100%
Potatoes, Baked (4 medium)	13 to 19 min	100%
Summer Squash (1 lb [.45 kg])	3 to 8 min	100%
Other		
Applesauce (4 servings)	7 to 9 min	100%
Baked Apples (4)	4 to 6 min	100%
Chocolate (melt 1 square)	1 to 2 min	50%
Eggs, Scrambled (2)	1 min 15 sec to 1 min 45 sec	100%
Eggs, Scrambled (4)	2 to 3 min	100%
Hot Cereals (1 serving)	1½ to 5 min	100%
Hot Cereals (4 servings)	4½ to 7 min	100%
Nachos (large plate)	1½ to 2½ min	50%
Water for Beverage (1 cup [250 mL])	2½ to 4 min	100%
Water for Beverage (2 cups [500 mL])	4½ to 6 min	100%

MICROWAVE REHEAT CHART

These times are approximate and may need to be adjusted to suit individual taste. If using Broil to reheat, do not cover food.

FOOD/STARTING TEMPERATURE	COOK TIME	COOK POWER	PREPARATION
Meat (Chicken pieces, chops, hamburgers, meat loaf slices) 1 serving/Refrigerated 2 servings/Refrigerated	1-2 min 2½-4½ min	70% 70%	Cover loosely.
Meat Slices (Beef, ham, pork, turkey) 1 or more servings/Room Temp. 1 or more servings/Refrigerated	45 sec-1 min per serving 1-3 min per serving	50% 50%	Cover with gravy or wax paper. Check after 30 sec per serving.
Stirrable Casseroles and Main Dishes 1 serving/Refrigerated 2 servings/Refrigerated 4-6 servings/Refrigerated	2-4 min 4-6 min 6-8 min	100% 100% 100%	Cover. Stir after half the time.
Nonstirrable Casseroles and Main Dishes 1 serving/Refrigerated 2 servings/Refrigerated 4-6 servings/Refrigerated	5-8 min 9-13 min 13-16 min	50% 50% 50%	Cover with wax paper.
Soup, Cream 1 cup (250 mL)/Refrigerated 1 can (10 oz [284 mL])/Room Temp.	3-4½ min 5-7 min	50% 50%	Cover. Stir after half the time.
Soup, Clear 1 cup (250 mL)/Refrigerated 1 can (10 oz [284 mL])	2½-3½ min 4-5½ min	100% 100%	Cover. Stir after half the time.
Pizza (Medium slice) 1 slice/Room Temp. 2 slices/Room Temp. 1 slice/Refrigerated 2 slices/Refrigerated	15-25 sec 30-40 sec 30-40 sec 45-55 sec	100% 100% 100% 100%	
Vegetables 1 serving/Refrigerated 2 servings/Refrigerated	45 sec-1½ min 1½-2½ min	100% 100%	Cover. Stir after half the time.
Baked Potato 1/Refrigerated 2/Refrigerated	1-2 min 2-3 min	50% 50%	Cut lengthwise, then several times crosswise. Cover with wax paper.
Breads (Dinner or breakfast roll) 1 roll/Room Temp. 2 rolls/Room Temp. 4 rolls/Room Temp.	8-12 sec 11-15 sec 18-22 sec	50% 100% 100%	Wrap single piece in paper towel. Place several pieces on paper towel, then cover with another paper towel.
Pie Whole/Refrigerated 1 slice/Refrigerated	5-7 min 30 sec	70% 100%	

OVEN CARE

General Cleaning

IMPORTANT: Before cleaning, make sure all controls are off and the oven is cool. Always follow label instructions on cleaning products.

Soap, water and a soft cloth or sponge are suggested first unless otherwise noted.

STAINLESS STEEL (on some models)

Do not use soap-filled scouring pads, abrasive cleaners, Cooktop Polishing Creme, steel-wool pads, gritty wash cloths or some paper towels. Damage may occur.

Rub in direction of grain to avoid damaging.

- Stainless Steel Cleaner & Polish (not included):
See "Assistance or Service" section to order.
- Liquid detergent or all-purpose cleaner:
Rinse with clean water and dry with soft, lint-free cloth.
- Vinegar for hard water spots

OVEN DOOR EXTERIOR

- Glass cleaner and paper towels or non-abrasive plastic scrubbing pad:
Apply glass cleaner to soft cloth or sponge, not directly on panel.

OVEN CAVITY

Do not use soap-filled scouring pads, abrasive cleaners, steel-wool pads, gritty wash cloths or some paper towels. Damage may occur.

On stainless steel models, rub in direction of grain to avoid damaging.

The area where the oven door and frame touch when closed should be kept clean.

Average soil

- Mild, non-abrasive soaps and detergents:
Rinse with clean water and dry with soft, lint-free cloth.

Heavy soil

- Mild, non-abrasive soaps and detergents:
Heat 1 cup (250 mL) of water for 2 to 5 minutes in oven. Steam will soften soil. Rinse with clean water and dry with soft, lint-free cloth.

Odors

- Lemon juice or vinegar:
Heat 1 cup (250 mL) of water with 1 tablespoon (15 mL) of either lemon juice or vinegar for 2 to 5 minutes in oven.

TURNTABLE

Do not operate the microwave without the turntable in place.

- Mild cleanser and scouring pad
- Dishwasher

GRIDS

- Steel wool pad
- Dishwasher

CRISPER PAN

- Mild cleanser and scouring sponge
- Dishwasher

TROUBLESHOOTING

Try the solutions suggested here first in order to avoid the cost of an unnecessary service call.

Nothing will operate

- **Has a household fuse been blown or has the circuit breaker been tripped?**
Replace the fuse or reset the circuit.
- **Is the appliance wired properly?**
See Installation Instructions.

Oven will not operate

- **Is the door completely closed?**
Firmly close door.
- **Is the electronic oven control set correctly?**
See "Electronic Oven Control" section.
- **On some models, is the Control Lock set?**
See "Control Lock" section.
- **On some models, is the Sabbath Mode set?**
See "Sabbath Mode" section.
- **On combination oven models, is the lower oven self-cleaning?**
The upper oven will not work during the lower oven Self-Cleaning Cycle.
- **Is the magnetron working properly?**
Heat 1 cup (250 mL) of cold water for 2 minutes at 100% cooking power. If water does not heat, call for service. See "Assistance or Service" section.

Oven makes humming noise

- This is normal and occurs when the transformer in the magnetron cycles on.

Oven door looks wavy

- This is normal and will not affect performance.

Turntable will not operate

- **Is the turntable properly in place?**
Make sure turntable is correct-side up and is sitting securely on the turntable support.
- **Is the turntable support operating properly?**
Remove turntable. Remove and replace turntable support. Replace turntable. Put in 1 cup (250 mL) of water, then restart oven. If still not working, call for service. See "Assistance or Service" section. Do not operate the oven without turntable and turntable support working properly.

Turntable rotates both directions

- This is normal and depends on motor rotation at beginning of cycle.

Display shows messages

- **Is the display showing “PF”, “PF id=27” or “PF id=30”?**
There has been a power failure. Clear the display. See “Display(s)” section. On some models, reset the clock, if needed. See “Clock” section.
- **Is the display showing a letter followed by a number?**
Clear the display. See “Display(s)” section. If it reappears, call for service. See “Assistance or Service” section.

Display shows time countdown, but is not operating

- **Is the Minute Timer in use?**
See “Minute Timer” section.

Tones are not sounding

- **Are tones disabled?**
See “Tones” section.

Smoke is coming from oven vent during broiling

- Some smoke is normal and occurs just as in conventional broiling.

Sparking during broiling

- This is normal and occurs as fat burns off from past cooking. Sparking will stop once fat is completely burned off.

Cooking times seem too long

- **Is the cooking power set properly?**
See “Cooking Power” in “Microwave Cooking” section.
- **Are large amounts of food being heated?**
Larger amounts of food need longer cooking times.
- **Is the incoming voltage less than specified in “Parts and Features”?**
Have a qualified electrician check the electrical system of the house.

ASSISTANCE OR SERVICE

Before calling for assistance or service, please check “Troubleshooting.” It may save you the cost of a service call. If you still need help, follow the instructions below.

When calling, please know the purchase date and the complete model and serial number of your appliance. This information will help us to better respond to your request.

If you need replacement parts

If you need to order replacement parts, we recommend that you only use FSP® replacement parts. FSP® replacement parts will fit right and work right because they are made with the same precision used to build every new WHIRLPOOL® appliance.

To locate FSP® replacement parts in your area, call our Customer Interaction Center telephone number or your nearest Whirlpool designated service center.

In the U.S.A.

Call the Whirlpool Customer Interaction Center toll free: **1-800-253-1301**.

Our consultants provide assistance with:

- Features and specifications on our full line of appliances.
- Installation information.
- Use and maintenance procedures.
- Accessory and repair parts sales.
- Specialized customer assistance (Spanish speaking, hearing impaired, limited vision, etc.).
- Referrals to local dealers, repair parts distributors, and service companies. Whirlpool designated service technicians are trained to fulfill the product warranty and provide after-warranty service, anywhere in the United States.

To locate the Whirlpool designated service company in your area, you can also look in your telephone directory Yellow Pages.

For further assistance

If you need further assistance, you can write to Whirlpool Corporation with any questions or concerns at:

Whirlpool Brand Home Appliances
Customer Interaction Center
553 Benson Road
Benton Harbor, MI 49022-2692

Please include a daytime phone number in your correspondence.

Accessories U.S.A.

To order accessories, call the Whirlpool Customer Interaction Center toll free at **1-800-442-9991** and follow the menu prompts. Or visit our website at www.whirlpool.com and click on “Buy Accessories Online.”

Stainless Steel Cleaner & Polish

(stainless steel models)
Order Part #4396095

In Canada

For product related questions, please call the Whirlpool Canada Inc. Customer Interaction Center toll free: **1-800-461-5681** 8:30 a.m. - 5:30 p.m. EST.

Our consultants provide assistance with:

- Features and specifications on our full line of appliances.
- Referrals to local dealers.

For parts, accessories and service in Canada

Call **1-800-807-6777**. Whirlpool Canada Inc. designated service technicians are trained to fulfill the product warranty and provide after-warranty service, anywhere in Canada.

For further assistance

If you need further assistance, you can write to Whirlpool Canada Inc. with any questions or concerns at:

Customer Interaction Center
Whirlpool Canada Inc.
1901 Minnesota Court
Mississauga, Ontario L5N 3A7

Please include a daytime phone number in your correspondence.

WHIRLPOOL® HIGH SPEED MICROWAVE OVEN WARRANTY

ONE-YEAR FULL WARRANTY

For one year from the date of purchase, when this appliance is operated and maintained according to instructions attached to or furnished with the product, Whirlpool Corporation will pay for FSP® replacement parts and repair labor costs to correct defects in materials or workmanship. Service must be provided by a Whirlpool designated service company.

SECOND THROUGH FIFTH YEAR LIMITED WARRANTY ON MAGNETRON TUBE

From the second through fifth year from the date of purchase, when this appliance is operated and maintained according to instructions attached to or furnished with the product, Whirlpool Corporation will pay for FSP® replacement parts for the microwave magnetron tube if defective in materials or workmanship.

Whirlpool Corporation will not pay for:

1. Service calls to correct the installation of your appliance, to instruct you how to use your appliance, to replace house fuses or correct house wiring, or to replace owner-accessible light bulbs.
 2. Repairs when your appliance is used in other than normal, single-family household use.
 3. Pickup and delivery. Your appliance is designed to be repaired in the home.
 4. Damage resulting from accident, alteration, misuse, abuse, fire, flood, improper installation, acts of God or use of products not approved by Whirlpool Corporation or Whirlpool Canada Inc.
 5. Repairs to parts or systems resulting from unauthorized modifications made to the appliance.
 6. Replacement parts or repair labor costs for units operated outside the United States or Canada.
 7. In Canada, travel or transportation expenses for customers who reside in remote areas.
 8. Any labor costs during the limited warranty period.
-

WHIRLPOOL CORPORATION AND WHIRLPOOL CANADA INC. SHALL NOT BE LIABLE FOR INCIDENTAL OR CONSEQUENTIAL DAMAGES.

Some states or provinces do not allow the exclusion or limitation of incidental or consequential damages, so this exclusion or limitation may not apply to you. This warranty gives you specific legal rights and you may also have other rights which may vary from state to state or province to province.

Outside the 50 United States and Canada, this warranty does not apply. Contact your authorized Whirlpool dealer to determine if another warranty applies.

If you need service, first see the "Troubleshooting" section of this book. After checking "Troubleshooting," additional help can be found by checking the "Assistance or Service" section or by calling the Whirlpool Customer Interaction Center, **1-800-253-1301** (toll-free), from anywhere in the U.S.A. For parts and service in Canada, please call **1-800-807-6777**. For product related questions in Canada, please call **1-800-461-5681**.

5/00

Keep this book and your sales slip together for future reference. You must provide proof of purchase or installation date for in-warranty service.

Write down the following information about your appliance to better help you obtain assistance or service if you ever need it. You will need to know your complete model number and serial number. You can find this information on the model and serial number label/plate, located on your appliance as shown in the "Parts and Features" section.

Dealer name _____
Address _____
Phone number _____
Model number _____
Serial number _____
Purchase date _____

8300346B

© 2002 Whirlpool Corporation.
All rights reserved.

© Registered Trademark/TM Trademark of Whirlpool, U.S.A., Whirlpool Canada Inc. licensee in Canada
© Styrofoam is a Registered Trademark of The Dow Chemical Company.



3/02
Printed in U.S.A.

Free Manuals Download Website

<http://myh66.com>

<http://usermanuals.us>

<http://www.somanuals.com>

<http://www.4manuals.cc>

<http://www.manual-lib.com>

<http://www.404manual.com>

<http://www.luxmanual.com>

<http://aubethermostatmanual.com>

Golf course search by state

<http://golfingnear.com>

Email search by domain

<http://emailbydomain.com>

Auto manuals search

<http://auto.somanuals.com>

TV manuals search

<http://tv.somanuals.com>