

# Installation Instructions

	<b>⚠ WARNING</b>
	<ul style="list-style-type: none"><li>• ALL RANGES CAN TIP</li><li>• INJURY TO PERSONS COULD RESULT</li><li>• INSTALL ANTI-TIP DEVICE PACKED WITH RANGE</li><li>• SEE INSTALLATION INSTRUCTIONS</li></ul>

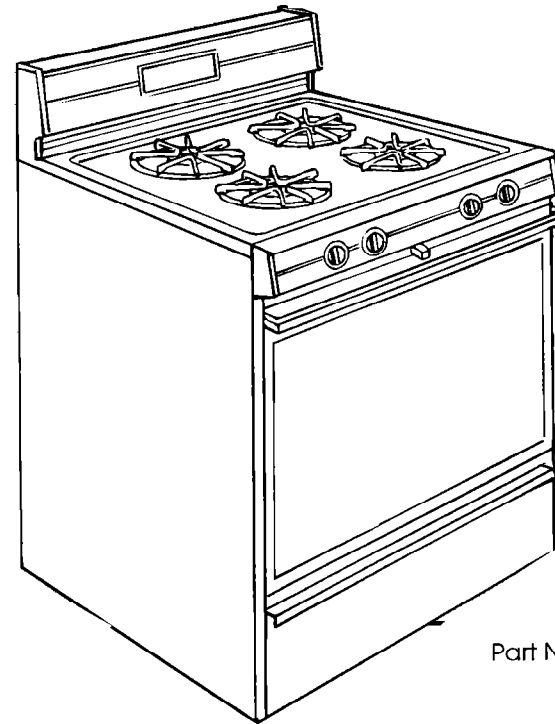

Part No. 316002904/4371006 Rev. B

**IMPORTANT:**  
Read and save  
these instructions.

**IMPORTANT:**

**Installer:** Leave Installation Instructions with the homeowner.

**Homeowner:** Keep Installation Instructions for future reference.

**Save** Installation Instructions for local electrical inspector's use.

**30" Freestanding  
Gas Range**  
with self-cleaning oven

1-93

## Before you start...

Proper installation is your responsibility. A qualified technician must install this range. Make sure you have everything necessary for correct installation. It is the responsibility of the installer to comply with the installation clearances specified on the serial/rating plate. The serial/rating plate is located under the cooktop.

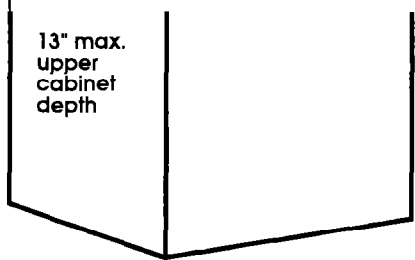

13" max. upper cabinet depth

18" min. clearance upper cabinet to countertop

30" min. opening width

1" min. countertop space to side wall or other combustible material.

**Check location** where range will be installed. The range should be located away from strong draft areas, such as windows, doors and strong heating vents or fans. The range should be located for convenient use in the kitchen. Recessed installations must provide complete enclosure of the sides and rear of range.

NOTE: Clearances specified are for combustible walls and materials that have a density of 20 or more pounds per cubic foot. No evaluation of clearances has been made for installation adjacent to materials that are less than 20 pounds per cu. ft. or to plastic tiles and sheeting.

Do Not pinch the power cord between the range and wall.

Grounded electrical outlet is required. See Electrical requirements.

## Important: Observe all governing codes and ordinances.

\* Note: 30" min. when bottom of wood or metal cabinet is protected by not less than 1/4" flame retardant millboard covered with not less than No.28 MSG sheet steel, 0.015" stainless steel, 0.024" aluminum or 0.020" copper.

36" min. clearance between the top of the cooking platform and the bottom of an unprotected wood or metal cabinet.

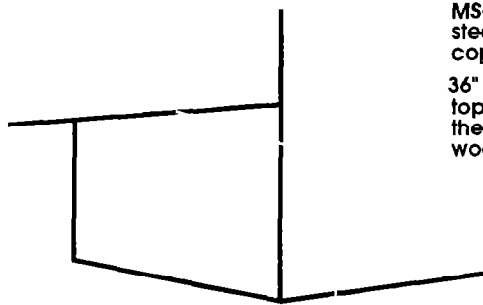

For minimum clearances, see Note.\*

The anti-tip bracket MUST be installed. For detailed instructions, see Panel B.

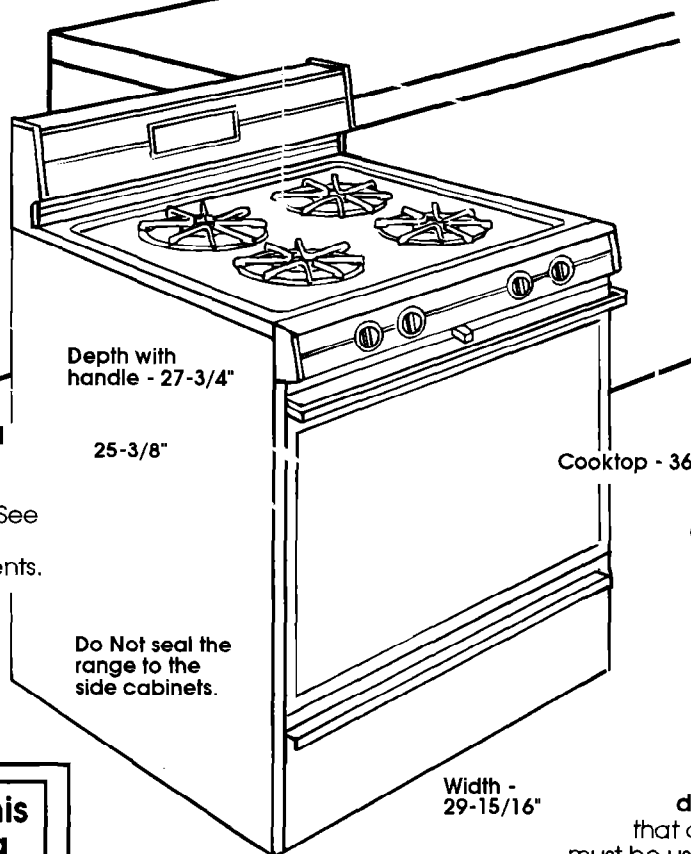

Depth with handle - 27-3/4"

25-3/8"

Cooktop - 36"

Overall - 46-1/4"

Width - 29-15/16"

Do Not seal the range to the side cabinets.

Cabinet opening dimensions that are shown must be used. Given dimensions provide 0" clearance.

Proper gas supply connection must be available. See Gas supply requirements.

ALL OPENINGS IN THE WALL OR FLOOR WHERE THE RANGE IS TO BE INSTALLED MUST BE SEALED.

## Electrical and gas dimensions

Shaded area is recommended area for 120v outlet on rear wall and area for through-the-wall connection of gas pipe and shutoff valve.

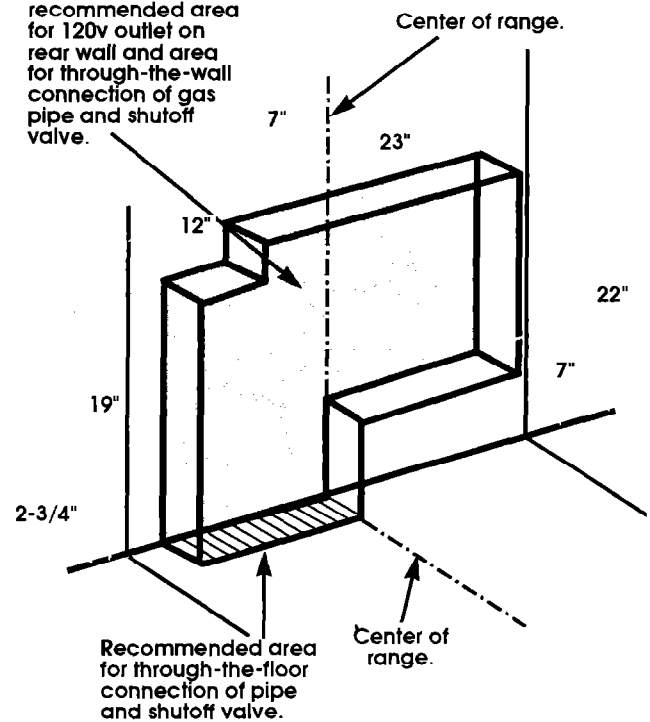

Recommended area for through-the-floor connection of pipe and shutoff valve.

## Mobile Home Installation

The installation of this range must conform to the Manufactured Home Construction and Safety Standards, Title 24 CFR, Part 3280 (formerly the Federal Standard for Mobile Home Construction and Safety, Title 24, HUD Part 280) or when such standard is not applicable, the Standard for Manufactured Home Installation 1982 (Manufactured Home Sites, Communities and Setups), ANSI Z225.1-NFPA 501A - latest edition, or with local codes.

When this range is installed in a mobile home, it must be secured to the floor. Any method of securing the range is adequate as long as it conforms to the standards listed above.

Copies of the standards listed may be obtained from:

\* National Fire Protection Association  
Batterymarch Park  
Quincy, Massachusetts 02269

\*\* American Gas Association  
1515 Wilson Boulevard  
Arlington, Virginia 22209

**WARNING: If the information in this manual is not followed exactly, a fire or explosion may result causing property damage, personal injury or death.**

- Do Not store or use gasoline or other flammable vapors and liquids in the vicinity of this or any other appliance.
- WHAT TO DO IF YOU SMELL GAS
  - Do Not try to light any appliance.
  - Do Not touch any electrical switch; Do Not use any phone in your building.
  - Immediately call your gas supplier from a neighbor's phone. Follow the gas supplier's instructions.
  - If you cannot reach your gas supplier, call the fire department.
- Installation and service must be performed by a qualified installer, service agency or the gas supplier.

## WARNING

### Fire Hazard

Do Not obstruct the flow of combustion and ventilation air.

### Personal Injury Hazard

Avoid installing cabinet storage above the cooking surface. If cabinets are already installed, reduce the hazard of reaching over a heated cooking surface by installing a range hood. The range hood should extend a minimum of 5 inches out from the bottom front of the cabinets.

Reaching over a heated cooking surface could result in a serious burn.

### Electrical Shock Hazard

It is the customer's responsibility:

- To contact a qualified electrical installer.
- To assure that the electrical installation is adequate and in conformance with National Electrical Code, ANSI/NFPA 70 — latest edition\*, and all local codes and ordinances.

Failure to do so could result in electrical shock or other personal injury.

## CAUTION

### Property Damage

- Contact a qualified floor covering installer to check that the floor covering can withstand heat at least 90°F above room temperature.
  - Use an insulated pad or 1/4" plywood under range if installing range over carpeting.
- Failure to do so may result in damage to floor covering.

## Tools and materials needed for installation:

- gas line shutoff valve
- L.P.-resistant pipe-joint compound
- AGA design-certified flexible metal connector (4-5 feet)
- flare union adapter for connection to pressure regulator (1/2" NPT x 1/2" or 3/4" I.D.)
- hand or electric drill
- wood/metal wall stud: 1/8-inch drill bit
- concrete/concrete block walls: 3/16-inch carbide-tipped masonry drill bit

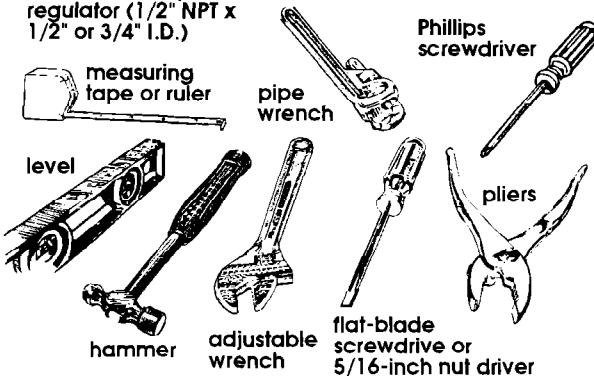

## Parts supplied for installation:

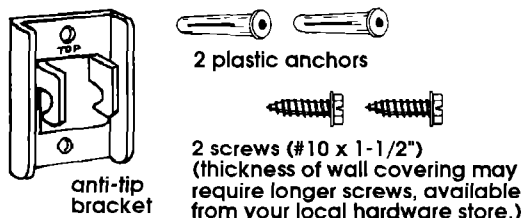

## Gas supply requirements

Observe all governing codes and ordinances.

## WARNING

### Fire Hazard

- Range must be connected to a regulated gas supply.
- L.P. gas supply must Not exceed a pressure of 14" water column. This must be checked by a qualified technician before installing the range.
- Do Not use an open flame to test for leaks from gas connections.
- New, A.G.A.-approved, flexible gas line should be used when codes permit.

Failure to follow these instructions could result in a fire, explosion or personal injury.

**A.** This installation must conform with local codes and ordinances. In the absence of local codes, installations must conform with American National Standard, National Fuel Gas Code ANSI Z223.1-latest edition.\*\*

**B.** Input ratings shown on the serial/rating plate are for elevations up to 2,000 feet. For elevations above 2,000 feet, ratings are reduced at a rate of 4% for each 1,000 feet above sea level.

**C.** This range is equipped for use with NATURAL gas. It is design-certified by A.G.A. for NATURAL and L.P. gases with appropriate conversion. The serial/rating plate located under the cooktop has information on the type of gas that can be used. If this information does not agree with the type of gas available, check with the local gas supplier. See Panel C and back cover for L.P. gas conversion instructions.

**D.** Provide a gas supply line of 3/4" rigid pipe to the range location. A smaller size pipe on long runs may result in insufficient gas supply. Pipe-joint compounds made for use with L.P. gas must be used. With L.P. gas, piping or tubing size can be 1/2" minimum. L.P. gas suppliers usually determine the size and materials used on the system.



**E.** If local codes permit, a new A.G.A. design-certified, 4 - 5 foot long, 1/2" or 3/4" I.D., flexible metal appliance connector is recommended for connecting this range to the gas supply line. Do Not kink or damage the flexible tubing when moving the range. A 1/2" male pipe thread is needed for connection to pressure regulator female pipe threads.

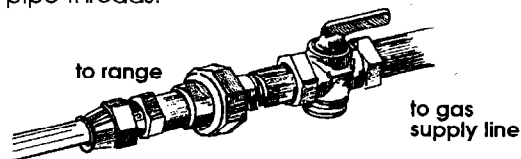

**F.** The supply line shall be equipped with an approved shutoff valve. This valve should be located in the same room as the range and should be in a location that allows ease of opening and closing. Do Not block access to shutoff valve.

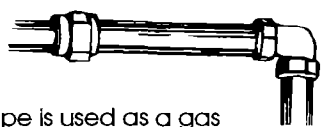

**G.** If rigid pipe is used as a gas supply line, a combination of pipe fittings must be used to obtain an in-line connection to the range. All strains must be removed from the supply and fuel lines so range will be level and in line.

**H.** The regulator must be checked at a minimum of 1-inch water column above the set pressure. The inlet pressure to the regulator should be as follows for operation:

- NATURAL GAS:**  
 Set pressure 5 inches  
 Maximum pressure 14 inches
- L.P. GAS:**  
 Set pressure 11 inches  
 Maximum pressure 14 inches

**I.** Line pressure testing:  
**Testing above 1/2 psi (gauge)**  
 The range and its individual shutoff valve must be disconnected from the gas supply piping system during any pressure testing of that system at test pressures greater than 1/2 psig (3.5 kPa).  
**Testing at 1/2 psi (gauge)**  
 The range must be isolated from the gas supply piping system by closing its individual manual shutoff valve during any pressure testing of the gas supply piping system at test pressures equal to or less than 1/2 psig (3.5 kPa).

## Electrical requirements

### ⚠ WARNING

#### Electrical Shock Hazard

- Electrical ground is required on this appliance.
- Improper connection of the equipment-grounding conductor can result in fire, electrical shock, or other personal injury.
- Check with a qualified electrician if you are in doubt as to whether the appliance is properly grounded.
- Do Not modify the power supply cord plug. If it does not fit the outlet, have a proper outlet installed by a qualified electrician.
- Do Not use an extension cord with this appliance.
- Do Not have a fuse in the neutral or grounding circuit. A fuse in the neutral or grounding circuit could result in an electrical shock.

Failure to follow these instructions could result in a fire, electrical shock or other personal injury.

### Panel B

A 120-volt, 60-Hz, AC-only, 15-ampere, fused electrical supply is required. A time-delay fuse or circuit breaker is recommended. It is recommended that a separate circuit serving only this appliance be provided. Electronic ignition systems operate within wide voltage limits, but proper grounding and polarity are necessary. In addition to checking that the outlet provides 120-volt power and is correctly grounded, the outlet must be checked by a qualified electrician to see if it is wired with correct polarity. The wiring diagram is found on a separate sheet in the literature package. The wiring diagram and Tech Sheet can also be found on the rear wall of the storage drawer.

## Recommended grounding method

**DO NOT, UNDER ANY CIRCUMSTANCES, REMOVE THE POWER SUPPLY CORD GROUNDING PRONG.**

For personal safety, this appliance is equipped with a power supply cord having a 3-prong grounding plug. To minimize possible shock hazard, the cord must be plugged into a mating 3-prong, grounding-type wall receptacle, grounded in accordance with the National Electrical Code, ANSI/NFPA 70-latest edition\* and all local codes and ordinances. If a mating wall receptacle is not available, it is the personal responsibility and obligation of the customer to have a properly grounded, 3-prong wall receptacle installed by a qualified electrician.

3-prong grounding plug

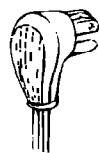

power supply cord

grounding prong



3-prong grounding-type wall receptacle

## Now start... With range in kitchen.

**1.** Remove shipping materials, tape and protective film from range. Keep cardboard shipping base under range. Remove oven racks and shipping materials from inside oven.

**2.** Adjust the leveling legs to a point where the range base does not touch the floor.

### ⚠ WARNING



- To prevent tipping, install range anti-tip bracket.
- Anti-tip bracket must be attached to a wood or metal wall stud, or concrete or concrete block wall.
- Do Not attach anti-tip bracket to a cabinet.
- Save these Installation Instructions. If range is moved to a new location, the anti-tip bracket must be reinstalled in the new location.

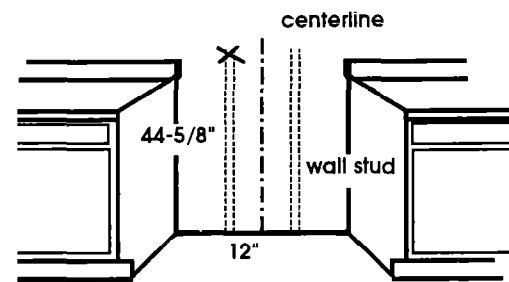

**3.** To mount anti-tip bracket to wood or metal wall stud: Find the wall stud that is closest to the center of the range location. (Note: Wall stud should **Not** be more than 12 inches to the right or left of center of range location.) Measure and mark at the center of the wall stud a distance of 44-5/8 inches up from the floor.

To mount anti-tip bracket to concrete or concrete block wall: Measure and mark on the rear wall at the center of the range location a distance 44-5/8 inches up from the floor. (Note: Anti-tip bracket may **Not** be installed more than 12 inches to the right or left of center of range location.)

### ⚠ WARNING

#### Electrical Shock Hazard

- Take special care when drilling holes into the wall. Electrical wires may be concealed behind the wall covering.
- Locate the electrical circuits that could be affected by the installation of this bracket and turn off the power to these circuits.

Failure to follow these instructions may result in electrical shock or other personal injury.

### ⚠ CAUTION

#### Property Damage

- Contact a qualified installer for the best procedure to drill mounting holes through the type of covering (i.e. ceramic tile) and into wall stud, concrete or concrete block wall.
- Before moving range across floor, check that range is on shipping base or slide range onto cardboard or hardboard.

Failure to follow these instructions may result in damage to wall or floor covering.

**4.** Line up the "TOP" mounting hole on anti-tip bracket with mark on wall. Use a pencil to mark the location of the top and bottom mounting holes. Remove bracket. If wall covering is ceramic tile, drill a 3/16-inch hole through tile only. Then proceed as follows:

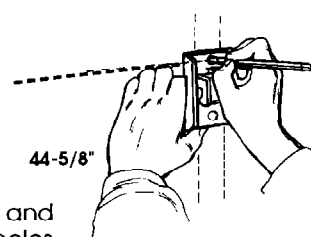

**For wood or metal wall studs:**

Drill 1/8-inch holes at each mounting hole location through wall and into stud.

**For concrete or concrete block wall:**

Drill 3/16-inch holes (1-3/4-inch minimum deep) at each mounting hole location. Tap plastic anchors into mounting holes with hammer.

**5.** Line up holes on bracket with holes on wall, making sure that the "TOP" mounting hole on bracket is lined up with top hole in wall. Securely fasten bracket to wall using screws provided.

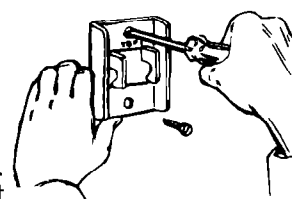

**6.** Plug range power supply cord into grounded outlet. Carefully slide range into position until range is approximately 2 inches from rear wall. Remove shipping base, cardboard or hardboard from under the range.

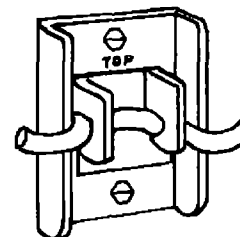

**7.** Push cable, located on rear of range, up and into the two hooks on the anti-tip bracket. Check that cable is secure in both hooks by pulling cable towards range. If cable comes out of hooks, reposition cable to insure that cable fits securely in both anti-tip bracket hooks. Slide range into final position.

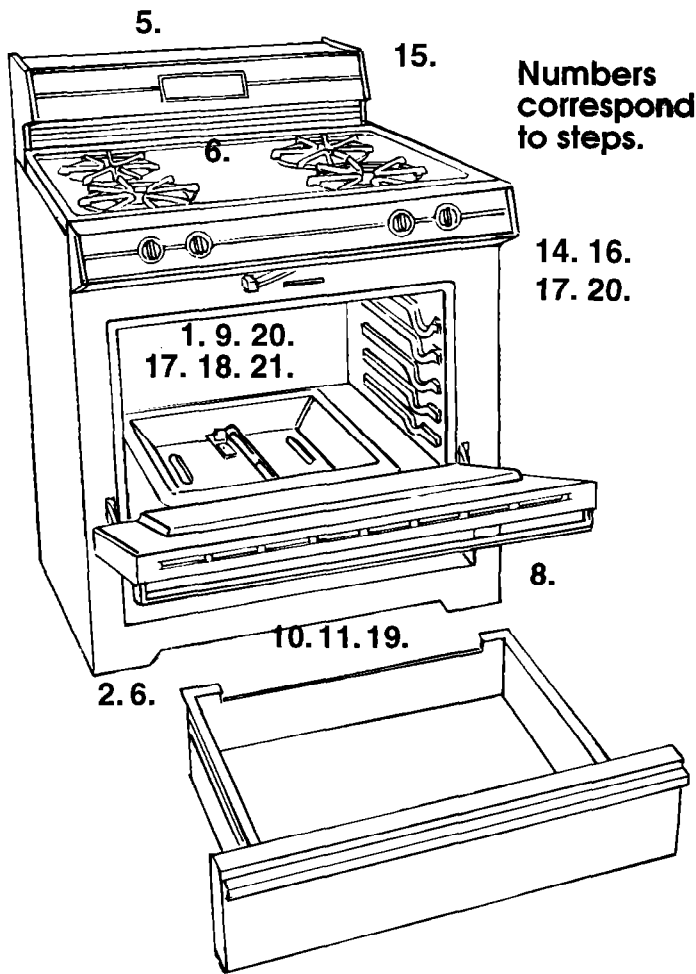

Numbers correspond to steps.

### Electronic Ignition System — initial lighting and gas flame adjustments.

Cooktop and oven burners use electronic igniters in place of standing pilots. When the cooktop control knob is turned to "LITE" position, the system creates a spark to light the burner. This sparking continues until the control knob is turned to the desired setting. When the oven control is turned to the desired setting, a glow bar heats up bright orange and ignites the gas. No sparking occurs and the glow bar remains on while the burners operate.

**14.** Check the operation of the cooktop burners. Push in and turn each control knob to "LITE" position. The flame should light within 4 seconds. **Do Not leave the knob in the "LITE" position after burner lights.**

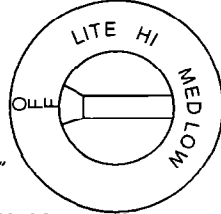

**15.** After burner lights, turn control knob to "HI" position. Check each cooktop burner for proper flame. At the "HI" setting, the small inner cone should have a very distinct blue flame 1/2" long. The outer cone is not as distinct as the inner cone. No air adjustment can be made.

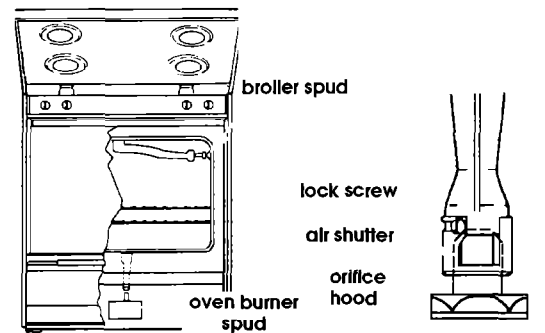
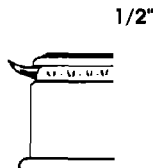

**19.** If oven flame needs to be adjusted, locate the air shutter near the center rear of the range. Loosen screw and adjust the air shutter until the proper flame appears. Tighten screw.

**20.** Check the operation of the oven broil burner.

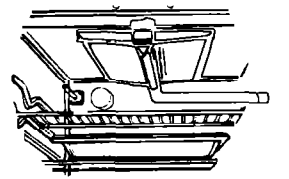

**If you have oven selector and temperature selector control knobs:** Turn the oven selector knob to "BROIL". Push in and turn the oven temperature selector knob to "BROIL". **The oven broil burner should light in 50 to 60 seconds. This delay is normal.** The oven safety valve requires a certain time before it will open and allow gas to flow.

**If you have electronic controls:** Push the "BROIL" button. "°F" will appear in the display. Turn the TIME/TEMP set knob one click and "LO" will appear in the display. The "BROIL" indicator light will come on when the oven turns on. **The oven broil burner should light in 50 to 60 seconds. This delay is normal.** The oven safety valve requires a certain time before it will open and allow gas to flow.

**21.** If the broiler flame needs adjustment:

1. Loosen the lock screw on the air shutter located at the rear of the broil burner.
2. Adjust the air shutter as needed. The flame should have a 1" long inner cone of bluish-green with an outer mantle of dark blue. The flame also should be clean and soft in character with no blowing or lifting of flame. Tighten the lock screw.

**22.** Replace burner baffle, oven bottom and racks.

**8.** If installing the range in a mobile home, you MUST secure the range to the floor. Any method of securing the range is adequate as long as it conforms to the standards listed in the Mobile Home Installation Instructions, Panel A.

**9.** Place rack in oven. Place level on rack, first side to side; then front to back. If range is not level, adjust the leveling legs up or down until the range is level.

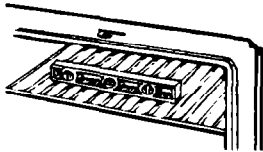

Note: Oven must be level for satisfactory baking conditions.

## WARNING

### Fire Hazard

Do Not make connection too tight. The regulator is die cast. Overtightening may crack the regulator, resulting in a gas leak and possible fire or explosion.

All connections must be wrench-tightened.

flexible connector manual shutoff valve



pressure regulator 1/2" flare union adapters

**10.** Assemble the flexible connector from the gas supply pipe to the pressure regulator located in the bottom rear of range in this order: shutoff valve, 1/2" flare union adapter, flexible connector, 1/2" flare union adapter. Seal all openings in floor or wall wherever range is installed.

**11.** Use pipe-joint compound made for use with Natural and L.P. gas to seal all gas connections. If flexible connectors are used, be certain connector is not kinked.

**12.** Open the shutoff valve in the gas supply line. Wait a few minutes for gas to move through the gas line.

## WARNING

### Fire Hazard

Do Not use an open flame to test for leaks from gas connections. Checking for leaks with a flame may result in a fire or explosion.

**13.** Use a brush and liquid detergent to test all gas connections for leaks. Bubbles around connections will indicate a leak. If a leak appears, shut off gas valve controls and adjust connections. Then check connections again. **NEVER TEST FOR GAS LEAKS WITH A MATCH OR OTHER FLAME.** Clean all detergent solution from range.

Panel C

**16.** Push in and turn the control knob to the "LITE" position and then to the "LOW" position. The low flame should be a minimum, steady, blue flame. To adjust the burner, remove the control knob and turn the adjustment screw in the center of the valve stem. Check the adjustment by turning the control knob from "HI" to "LOW" several times. The burner is properly adjusted when the low flame remains steady and the burner does not go out. Check each burner.

**17.** Remove oven rack. Remove oven screws at the rear of oven bottom. Pull oven bottom rear up and remove front of oven bottom from oven front. Remove oven bottom. Remove baffle. Check the operation of the oven burner.

If you have oven selector and temperature selector control knobs: Turn the oven selector knob to "Bake." Push in and turn temperature control knob to 300°F. **The oven burner should light in 50 to 60 seconds. This delay is normal.** The oven safety valve requires a certain time before it will open and allow gas to flow.

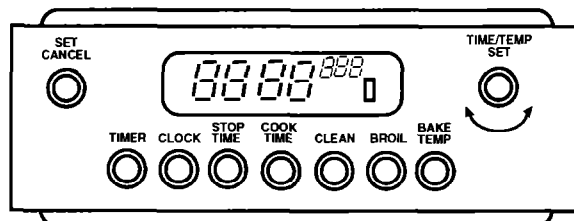
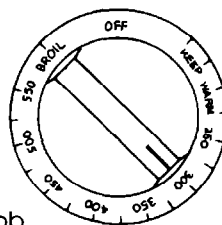

If you have electronic controls: Push "BAKE" button. "°F" will appear in the display. Turn Set knob until 350° appears in the display. **The oven burner should light in 50 to 60 seconds. This delay is normal.** The oven safety valve requires a certain time before it will open and allow gas to flow.

## CAUTION

### Product Damage

- Do Not insert any object into the openings of the protective shield that surrounds the ignitor.
- Do Not clean the area.

Failure to follow these instructions could result in product damage.

**18.** Check the oven burner for proper flame. This flame should have a 1" long, inner cone of bluish-green, with an outer mantle of dark blue, and should be clean and soft in character. No yellow tips, blowing or lifting of flame should occur.



To get the most efficient use from your new range, read your Use and Care Guide. Keep Installation Instructions and Guide close to range for easy reference.

## L.P. gas conversion

Converting to L.P. gas should be done by a qualified installer.

### A. Pressure regulator:

Remove storage drawer and oven rack. Remove oven bottom, see Step 17. Regulator is located in lower right-hand rear corner of range. Use a wrench to unscrew the cap from the top by turning counterclockwise. Turn the cap over so the hole end is up. Replace the cap and gasket on the regulator. **DO NOT REMOVE THE PRESSURE REGULATOR.**

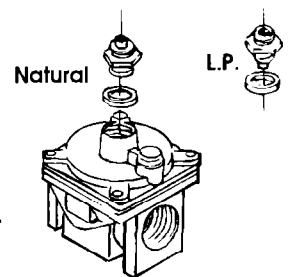

Nat. Gas increase gas increase flame size (Pre-set at factory for natural gas) Pin Spud L.P. Gas decrease gas decrease flame size

**B. Cooktop burners:** Turn the orifice hoods down snug onto pins (approximately 2 to 2-1/2 turns). **DO NOT OVERTIGHTEN.** The burner flames will not be properly adjusted if this conversion is not made.

## C. Broil burner:

Turn the orifice hood snug onto pins (approximately 2 to 2-1/2 turns). DO NOT OVERTIGHTEN.

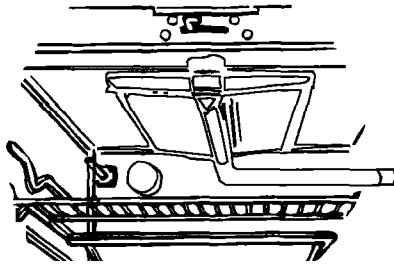

## D. Oven burner:

Turn the orifice hood down snug onto pin (approximately 2 to 2-1/2 turns). DO NOT OVERTIGHTEN. The burner flame cannot be properly adjusted if this conversion is not made.

### Adjusting for proper flame:

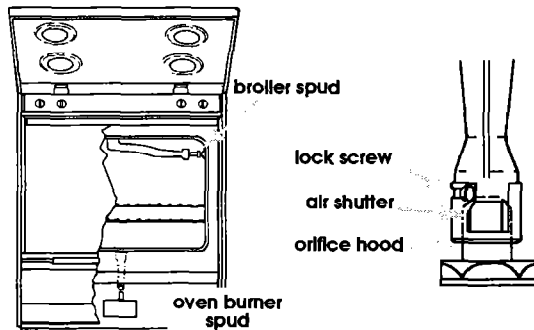

## CAUTION

### Product Damage

Electric igniters are used to light the oven and broil burners. Do Not insert any object into the openings of the shield surrounding the ignitor coil.

Do Not clean this area.

Failure to follow these instructions could result in product damage.

## A.

After all burners have been converted, turn the range gas supply valve back on.

## B. Cooktop burners:

No burner adjustment can be made.

Part No. 316002904/4371006 Rev. B  
©1993

## C. Broil burner:

1. Loosen the lock screw on the air shutter located at the rear of the broil burner.
2. Adjust the air shutter as needed. The flame should have a 1" long inner cone of bluish-green with an outer mantle of dark blue. The flame also should be clean and soft in character with no blowing or lifting of flame. Tighten the lock screw.

## D. Oven burner:

Locate the air shutter near the center rear of the oven burner. Loosen screw and adjust the air shutter as needed. The flame should have a 1" long, inner cone of bluish-green, with an outer mantle of dark blue. The flame also should be clean and soft in character with no blowing or lifting of flame. Tighten screw.

## E.

Replace the oven bottom, oven racks, baffle and storage drawer. Reinstall cooktop and burner grates.

After installation is complete, make sure all controls are left in the "OFF" position.

Reset all controls to the "OFF" position after using a programmable timing operation.

Make sure the air flow from the oven vent and the air flow to the bottom front of range is unobstructed.

## If range does not operate...

- Check that the circuit breaker is not tripped or the house fuse blown.
- Check that the power supply cord is plugged into wall receptacle.
- Check that the gas supply is turned on.

**NOTE: Refer to Use and Care Guide for operating instructions and cleaning instructions.**

## For cleaning and maintenance...

If removing the range is necessary for cleaning or maintenance, shut off gas supply to the range. Disconnect the gas and electric supply.

If the range or electrical supply is inaccessible, lift the range slightly at the front and pull the range out away from the wall. Pull the range out only as far as necessary to disconnect the gas and electric supply lines.

Remove the range to complete cleaning or maintenance.

Move range back into operating position. Insert cable into anti-tip bracket. Level the range. Connect gas line to range and check for leaks. Make sure that cable is secure in anti-tip bracket. Plug electric power supply cord into outlet.

## WARNING

### Personal Injury Hazard

Do Not step, lean or sit on the range or the door or drawer of the range.

Failure to follow this instruction could result in personal injury and/or product damage.

## If you need assistance...

Check your Use and Care Guide for a toll-free number to call or call the dealer from whom you purchased this appliance. The dealer is listed in the Yellow Pages of your phone directory under "Appliances — Major."

When you call, you will need the range model number and serial number. Both numbers can be found on the serial/rating plate located under the cooktop.

Benton Harbor, Michigan 49022

Printed in U.S.A.

## Free Manuals Download Website

<http://myh66.com>

<http://usermanuals.us>

<http://www.somanuals.com>

<http://www.4manuals.cc>

<http://www.manual-lib.com>

<http://www.404manual.com>

<http://www.luxmanual.com>

<http://aubethermostatmanual.com>

Golf course search by state

<http://golfingnear.com>

Email search by domain

<http://emailbydomain.com>

Auto manuals search

<http://auto.somanuals.com>

TV manuals search

<http://tv.somanuals.com>