

Installation Instructions

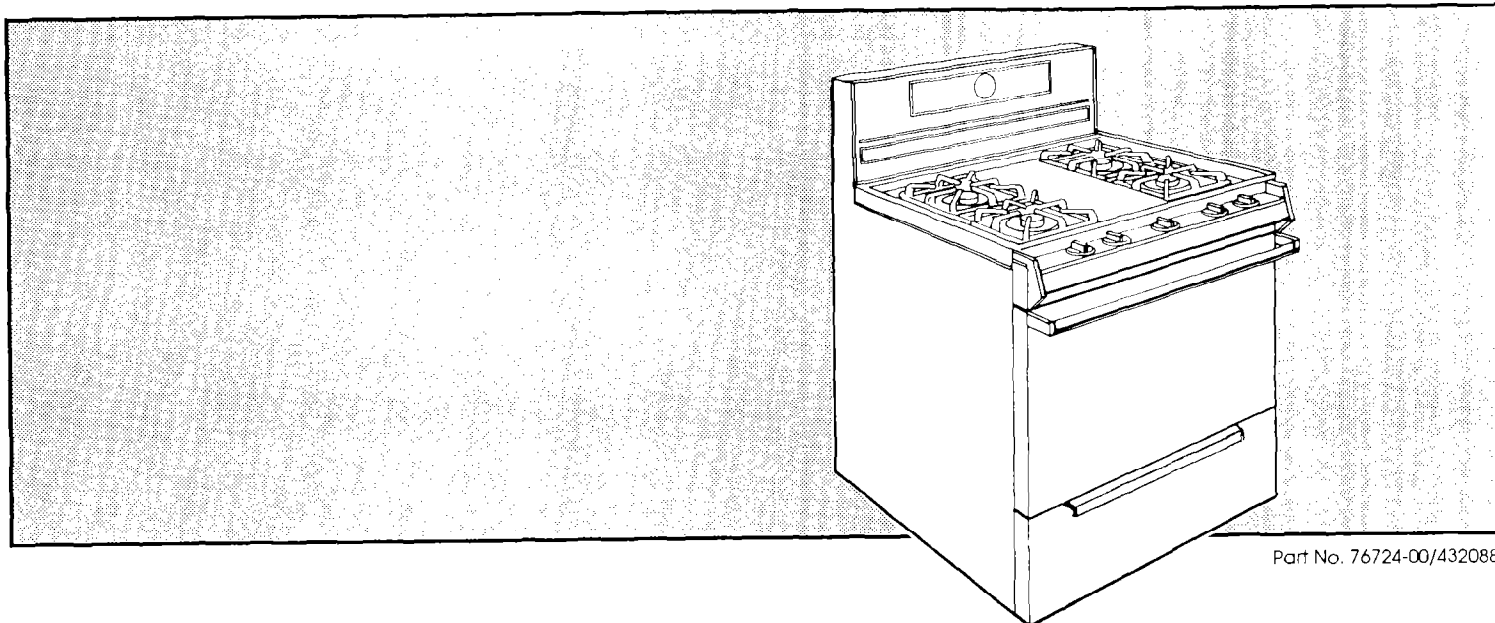

Part No. 76724-00/4320880

30" Freestanding Gas Range

IMPORTANT:

Installer: Leave Installation Instructions with the homeowner.

Homeowner: Keep Installation Instructions for future reference.

Save Installation Instructions for local electrical inspector's use.



Before you start...

Proper installation is your responsibility. Make sure you have everything necessary for correct installation. It is the responsibility of the installer to comply with the installation clearance specified on the serial/rating plate. The serial/rating plate can be found under the cooktop.

Check location where range will be installed. The location should be away from strong draft areas, such as windows, doors, and strong heating vents or fans. The range should be located for convenient use in the kitchen. Recessed installations must provide complete enclosure of the sides and rear of range.

ALL OPENINGS IN THE WALL OR FLOOR WHERE THE RANGE IS TO BE INSTALLED MUST BE SEALED

Note: Clearances specified are for combustible walls and materials that have a density of 20 or more pounds per cubic foot. No evaluation of clearances has been made for installations adjacent to materials that are less than 20 pounds per cu. ft. or to plastic tiles and sheeting.

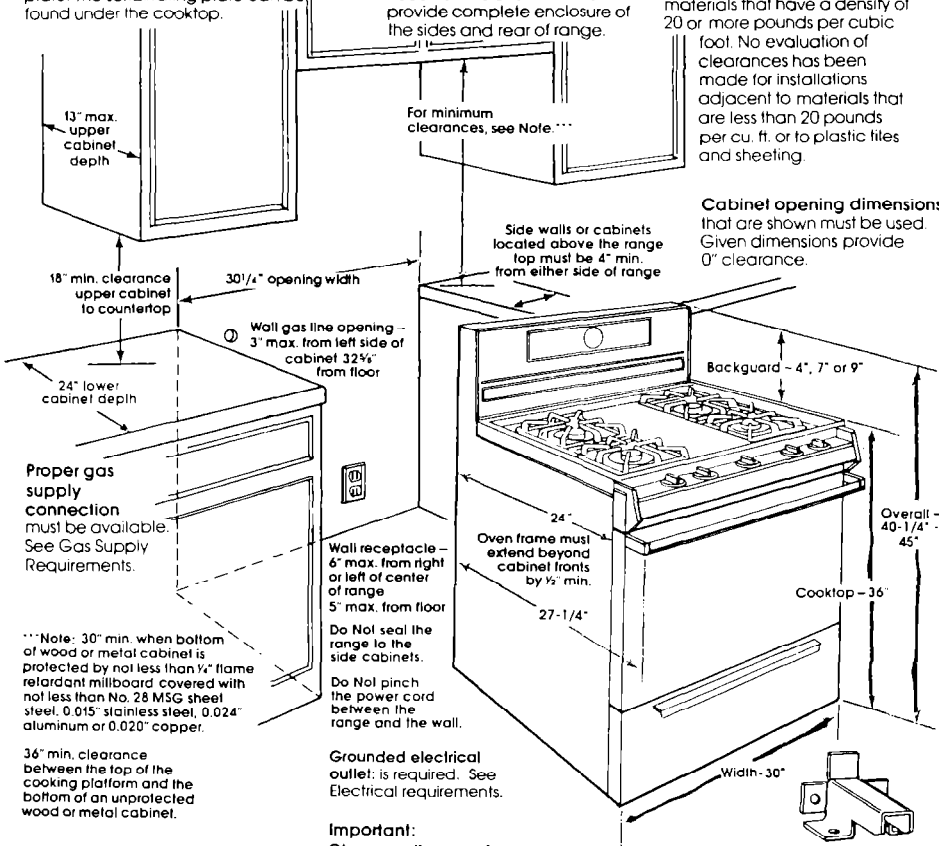

WARNING

Fire Hazard

- Do Not use or store gasoline, paint thinners and other flammable materials near range.
- Do Not obstruct the flow of combustion and ventilation air.
- If you smell gas:
 - Open windows.
 - Don't touch electrical switches.
 - Extinguish any open flame.
 - Immediately call your gas supplier.

Failure to follow these instructions could result in fire or explosion.

Personal Injury Hazard

Avoid installing cabinet storage above the cooking surface. If cabinets are already installed, reduce the hazard of reaching over a heated cooking surface by installing a range hood. The range hood should extend a minimum of 5 inches out from the bottom front of the cabinets.

Reaching over a heated cooking surface could result in a serious burn and personal injury.

Electrical Shock Hazard

It is the customer's responsibility:

- To contact a qualified electrical installer.
- To assure that the electrical installation is adequate and in conformance with National Electrical Code, ANSI/NFPA 70 - latest edition**, and all local codes and ordinances.

 Failure to do so could result in fire, electrical shock or other personal injury.

Mobile Home Installation

The installation of this range must conform to the Manufactured Home Construction and Safety Standards, Title 24 CFR, Part 3280 (formerly the Federal Standard for Mobile Home Construction and Safety, Title 24, HUD Part 280.)

When this range is installed in a mobile home, it must be secured to the floor during transit. Any method of securing the range is adequate as long as it conforms to the standards listed above.

Copies of the standard listed above may be obtained from:

American Gas Association
1515 Wilson Boulevard
Arlington, Virginia 22209

National Fire Protection Association
Batterymarch Park
Quincy, Massachusetts 02269

Tools needed for installation.

hand or electric drill
wood floors: 1/8" drill bit
concrete/ceramic floor: 1/4" masonry drill bit

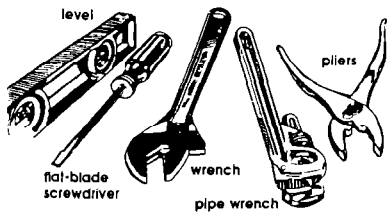

Gas supply requirements

Observe all governing codes and ordinances.

WARNING

Fire Hazard

- Range must be connected to a regulated gas supply.
- L.P. gas supply must Not exceed a pressure of 14" water column. This must be checked by a qualified technician before installing the oven.
- Do Not use an open flame to test for leaks from gas connections.
- New, flexible gas line must be used.

Failure to follow these instructions could result in a fire, explosion or personal injury.

A. This installation must conform with local codes and ordinances. In the absence of local codes, installation must conform with American National Standard, National Fuel Gas Code ANSI Z223.1 - latest edition.*

B. Input ratings shown on the serial/rating plate are for elevations up to 2,000 feet. For elevations above 2,000 feet, ratings should be reduced at a rate of 4% for each 1,000 feet above sea level.

C. This range is equipped for use with NATURAL gas. It is design-certified by A.G.A. for NATURAL and L.P. gases with appropriate conversion. The serial/rating plate located under the cooktop has information on the type of gas that can be used. If this information does not agree with the type of gas available, check with the local gas supplier. See back cover for L.P. gas conversion instructions.

D. Provide a gas supply line of 3/4" rigid pipe to the range location. Pipe-joint compounds resistant to the action of L.P. gas must be used. With L.P. gas, piping or tubing size can be 1/2" minimum. L.P. gas suppliers usually determine the size and materials used on their system.

E. If local codes permit, A.G.A. certified flexible metal tubing (new) is recommended for connecting this range to the gas supply line. Do not kink or damage the flexible tubing when moving the range. A 1/2" male pipe thread is needed for connection to pressure regulator female pipe threads.

F. The supply line shall be equipped with an approved shutoff valve. This valve should be located in the same room as the range and should be in a location that allows ease of opening and closing. Do not block access to shutoff valve.

G. If rigid pipe is used as a gas supply line, a combination of pipe fittings must be used to obtain an in-line connection to the range. All strains must be removed from the supply and fuel lines so range will be level and in line.

H. The inlet pressure to the regulator should be as follows for both operation and checking regulator setting:
NATURAL GAS:
Minimum pressure 6 inches
Maximum pressure 14 inches
L.P. GAS
Minimum pressure 11 inches
Maximum pressure 14 inches

I. The range and its individual shutoff valve must be disconnected from the gas supply piping system during any pressure testing of that system at test pressures in excess of 1/2 psig (3.5 kPa). The range must be isolated from the gas supply piping system by closing its individual manual shutoff valve during any pressure testing of the gas supply piping system at test pressures equal to or less than 1/2 psig (3.5 kPa).

Electrical requirements

(If model is so equipped.)

⚠ WARNING

Electrical Shock Hazard

- Electrical ground is required on this appliance.
 - Improper connection of the equipment-grounding conductor can result in fire, electrical shock, or other personal injury.
 - Check with a qualified electrician if you are in doubt as to whether the appliance is properly grounded. Do Not modify the power supply cord plug. If it will not fit the outlet, have a proper outlet installed by a qualified electrician.
 - Do Not use an extension cord with this appliance.
 - Do Not have a fuse in the neutral or grounding circuit. A fuse in the neutral or grounding circuit could result in an electrical shock.
- Failure to follow these instructions could result in fire, electrical shock or other personal injury.

A 120-Volt, 60-Hz, AC-only, 15-Ampere fused electrical supply is required (time-delay fuse or circuit breaker is recommended). It is recommended that a separate circuit serving only this appliance be provided.

Electronic ignition systems operate with wide voltage limits, but proper grounding and polarity are necessary. In addition to checking that the outlet provides 120-volt power and is correctly grounded, the outlet must be checked by a qualified electrician to see if it is correctly wired.

A wiring diagram is included in literature package. The wiring diagram is also located on the back of the range.

Recommended grounding method

DO NOT, UNDER ANY CIRCUMSTANCES, REMOVE THE POWER SUPPLY CORD GROUNDING PRONG.

For your personal safety, this appliance must be grounded. This appliance is equipped with a power supply cord having a 3-prong grounding plug. To minimize possible shock hazard, the cord must be plugged into a mating 3-prong grounding-type wall receptacle, grounded in accordance with the National Electrical Code, ANSI/NFPA 70 - latest edition**, and all local codes and ordinances. (See Figure 1.) If a mating wall receptacle is not available, it is the

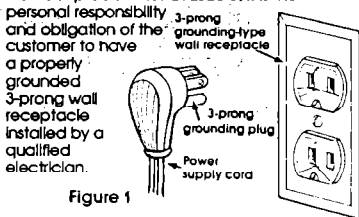

Figure 1

Alternate grounding method

DO NOT, UNDER ANY CIRCUMSTANCES, REMOVE THE POWER SUPPLY CORD GROUNDING PRONG.

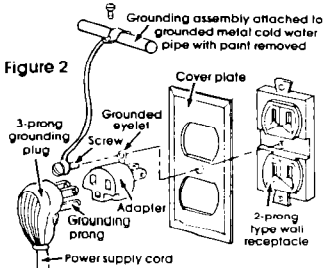
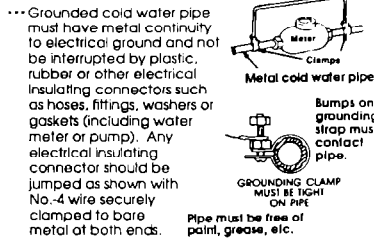

Figure 2

Electrical ground is required on this appliance.

If changing and properly grounding the wall receptacle is impossible and where local codes permit (consult your electrical inspector), a temporary adaptor may be plugged into the existing 2-prong wall receptacle to mate with the 3-prong power supply cord. If this is done, you must connect a separate copper grounding wire (No. 18 minimum) to a grounded cold water pipe*** by means of a clamp and then to the external grounding connector screw. Do not ground to a gas supply pipe or hot water pipe. Do not connect to electrical supply until appliance is permanently grounded. (See Figure 2.)



Now start... With range in kitchen.

1. Remove racks and other parts from inside oven.
2. Place one foot on the shipping base. Tilt range forward slightly to free rear legs. Gently lower range to floor. Tilt range backwards until front legs are free.
3. Remove shipping materials, tape and protective film from range. Do not remove cardboard shipping base at this time.
4. Tighten rear leveling legs up against range base.
5. The backguard may already be assembled to the range. If it is not, insert backguard supports into holder on the sides of the range. Press backguard down until locked into place. Lift cooktop and insert backguard electrical connector plug into receptacle in right rear of burner box area.

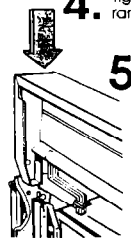

Check that wiring is not kinked or pinched between holders and backguard.

⚠ WARNING



- To prevent tipping, install range anti-tip bracket.
- Save these installation instructions. If range is moved to a new location, the anti-tip bracket must be removed and reinstalled in the new location.

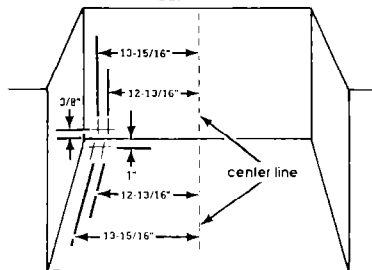

6. If the range will be installed with a cabinet on one or both sides, the anti-tip bracket must be installed. Anti-tip bracket may be fastened to the floor under range or wall behind range.

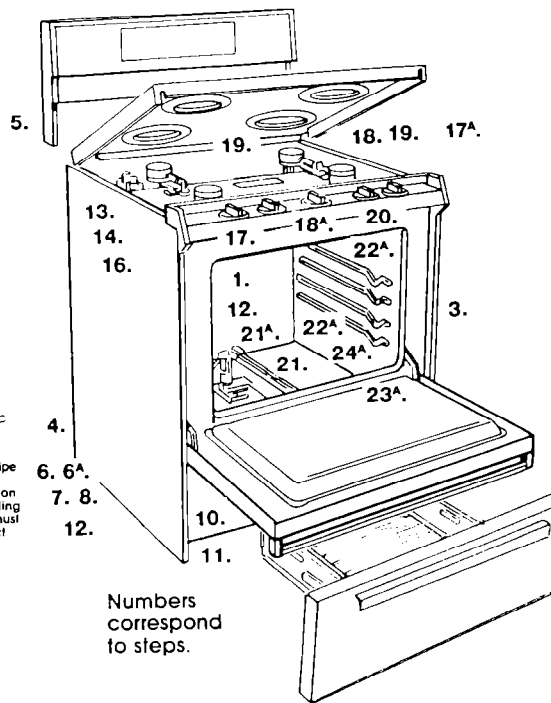

Numbers correspond to steps.

To install anti-tip bracket on wall:

- Measure and mark a line at the center of the cabinet opening on the rear wall. Measure and mark lines 12-13/16" and 13-15/16" from either the left or right side of the center line on the rear wall. Measure and mark on the rear wall a line 3/8" from the floor.

To install anti-tip bracket on floor:

- Measure and mark a line at the center of the cabinet opening on the floor. Measure and mark lines 12-13/16" and 13-15/16" from either the left or right side of the center line on the floor. Measure and mark on the floor a line 1" from the rear wall.

Note: If there is a cabinet on only one side, the anti-tip bracket must be installed next to the cabinet, using measurements given.

Go to Step 7.

- 6A. If the range will not be installed against a cabinet, the anti-tip bracket must be installed.

- Slide range into final location. Mark a line on the floor along each side of range about one-half the distance from the rear to the front.

To install anti-tip bracket on wall:

- Measure and mark a line on the rear wall at the center of the range location. Measure and mark lines 12-13/16" and 13-15/16" from the left or right sides of the center line on the rear wall. Measure and mark on the rear wall a line 3/8" from the floor.

To install anti-tip bracket on floor:

- Measure and mark a line on the floor at the center of the range location. Measure and mark lines 12-13/16" and 13-15/16" from the left or right side of the center line on the floor. Measure and mark on the floor a line 1" from the rear wall.

Go to Step 7.

⚠ CAUTION

Floor Damage

- Contact a qualified carpet installer for the best procedure to drill mounting holes through your type of carpet.
 - Before moving range across floor, slide range onto cardboard or hardboard.
- Failure to follow these instructions may result in damage to floor covering.

- 7.** To mount anti-tip bracket to wood floor or wall, drill 1/8" holes at the two mounting screw locations where the two lines are crossed by the third line.

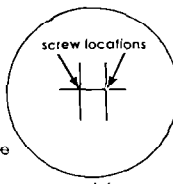

To mount anti-tip bracket to concrete or ceramic floor or wall, use a masonry drill bit to drill 1/4" holes at each mounting screw location. Tap plastic anchors into mounting holes in floor or wall.

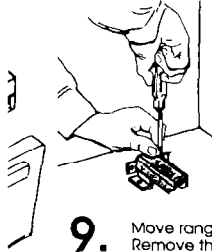
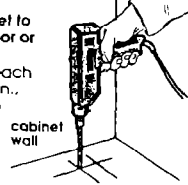

- 8.** Line up holes in anti-tip bracket with holes in floor or wall. Use the screws provided to mount the anti-tip bracket to the floor or wall.

- 9.** Move range close to final position. Remove the cardboard or hardboard form under the range. Plug power supply cord into grounded outlet.

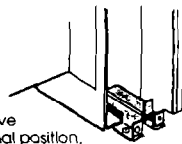

- 10.** Carefully move range into final position. Remove broiler drawer. Look under range (a flashlight may be needed) to check that anti-tip bracket overlaps range base. If anti-tip bracket does not overlap base, remove range and reposition bracket to insure that range base will fit properly under bracket.

- 11.** If installing the range in a mobile home, you MUST secure the range to the floor. Any method of securing the range is adequate as long as it conforms to the standards listed in the Mobile home installation instructions, Panel A.

- 12.** Place rack in oven. Place level on rack, first side to side, then front to back. If range is not level at the front, adjust front leveling legs up or down until the range is level. If rear of range needs adjusting, adjust rear leveling legs up or down until range is level. If rear legs are adjusted downward more than 1/8", add shims under anti-tip bracket.

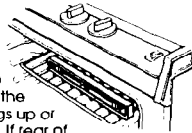

Note: Oven must be level for satisfactory baking conditions.

WARNING

Fire Hazard
Do Not make connection too tight. The regulator is die cast. Over tightening may crack the regulator, resulting in a gas leak and possible fire or explosion.

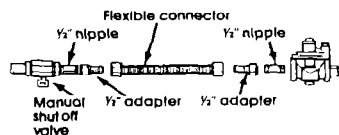

- 13.** Assemble the flexible connector from the gas supply pipe to the pressure regulator in order; manual shut off valve, 1/2" nipple, 1/2" adapter, flexible connector, 1/2" adapter, and 1/2" nipple.

- 14.** Use pipe-joint compound resistant to the action of L.P. gas to seal all gas connections. If flexible connectors are used, be certain connectors are not kinked.

- 15.** Open the shutoff valve in the gas supply line. Wait a few minutes for gas to move through the gas line.

WARNING

Fire Hazard
Do Not use an open flame to test for leaks from gas connections. Checking for leaks with a flame may result in a fire or explosion.

- 16.** Use a brush and liquid detergent to test all gas connections for leaks. Bubbles around connections will indicate a leak. If a leak appears, shut off gas valve controls and wrench-tighten connections. Then check connections again. NEVER TEST FOR GAS LEAKS WITH A MATCH OR OTHER FLAME. Clean all detergent solution from range.

Initial lighting and gas flame adjustments depend on type of system - electronic ignition or standing pilot. Raise cooktop and check which system is available. Continue installation, following steps under the heading for this range's system.

Electronic Ignition System

Cooktop and oven burner use electronic igniters in place of standing pilots. When the cooktop control knob is turned to the "LITE" position, the system creates a spark to light the burner. This sparking continues until the control knob is turned to the desired setting. When the oven control is turned on, the sparking will continue until the oven pilot ignites, then the sparking stops automatically.

- 17.** Check the operation of the cooktop burners. Push in and turn each control knob to "LITE" position. The flame should light within 4 seconds. Do not leave the knob in the "LITE" position after burner lights.

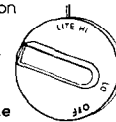

- 18.** After burner lights, turn control knob to "HI" position. Check each cooktop burner for proper flame. The small inner cone should have a very distinct blue flame 1/4" to 1/2" long. The outer cone is not as distinct as the inner cone.

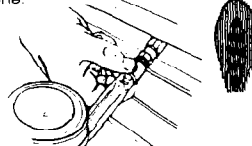

- 19.** If burners need adjusting for proper flame, adjust the air shutter to the widest opening that will not cause the flame to lift or blow off the burner. Repeat as necessary with each burner.

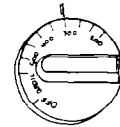

- 20.** Check the operation of the oven burner. Push in and turn the oven control knob to 300° F. The oven burner should light in 50 to 60 seconds. This delay is normal. The oven safety valve requires a certain time before it will open and allow gas to flow.

CAUTION

Product Damage
Do Not insert any object into the openings of the protective shield that surrounds the igniter coil. Do not clean the area. Failure to follow these instructions could result in product damage.

- 21.** Check the oven burner for proper flame. This flame should be 1/2" long, with inner cone of bluish-green, an outer mantle of dark blue and should be clean and soft in character. No yellow tips, blowing or lifting of flame should occur.

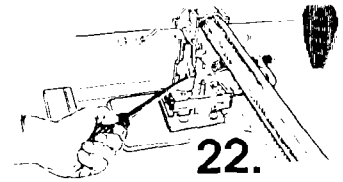

22.

If oven flame needs to be adjusted, loosen screw and adjust the air shutter until the proper flame appears. Tighten screw. Replace broiler drawer.

Standing Pilot Systems

- 17A.** Be sure all control knobs are in the "OFF" position. Raise the cooktop.

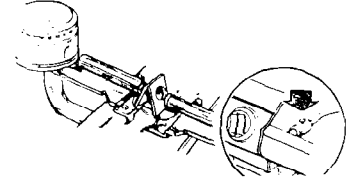

Use a match to light both pilots. Adjust pilot adjustment screw so pilot flame tip is 1/4" to 3/8" high and centered in the hole in the pilot housing. If the flame is too high, carbon (soot) will accumulate under the cooktop.

- 18A.** Check the operation of the cooktop burners. Push in and turn each control knob to "LITE" position. The flame should light within 4 seconds. Do not leave the knob in the "LITE" position after burner lights.

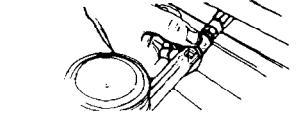

- 19A.** After burner lights, turn control knob to "HI" position. Check each cooktop burner for proper flame. The small inner cone should have a very distinct blue flame 1/4" to 1/2" long. The outer cone is not as distinct as the inner cone.

- 20A.** If burners need adjusting for proper flame, adjust the air shutter to the widest opening that will not cause the flame to lift or blow off of the burner. Repeat as necessary with each burner.



- 21A.** Make sure the oven control knob is in the "OFF" position. Remove the lower oven rack and oven bottom. Hold a lighted match to the opening in the top of the pilot at the rear of the oven burner. No pilot adjustments are required.

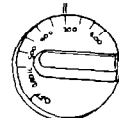

- 22A.** Check the operation of the oven burner. Push in and turn the oven control knob to 300° F. The oven burner should light in 50 to 60 seconds. This delay is normal. The oven safety valve requires a certain time before it will open and allow gas to flow.

- 23A.** Check the oven burner for proper flame. This flame should be 1/2" long, with inner cone of bluish-green, and outer mantle of dark blue and should be clean and soft in character. No yellow tips, blowing or lifting of flame should occur.



- 24A.** If oven flame needs to be adjusted, loosen screw and adjust the air shutter until the proper flame appears. Tighten screw. Replace broiler drawer.

You have just finished installing your new Whirlpool range. To get the most efficient use from your new range, read your Whirlpool Use & Care

Congratulations!

Guide. Keep Installation Instructions and Guide close to range for easy reference. The instructions will make reinstalling your Whirlpool range in another home as easy as the first installation.

L.P. Gas Conversion

(Electronic Ignition and Standing Pilot Systems)

Converting to L.P. gas should be done by a qualified installer.

A. Only a qualified installer should install or adjust your gas range.

Pressure Regulator: Use a wrench to unscrew the cap from the top by turning counter-clockwise. Turn the cap over so the hole end is up. Replace the cap and gasket on the regulator. **DO NOT REMOVE THE PRESSURE REGULATOR.**

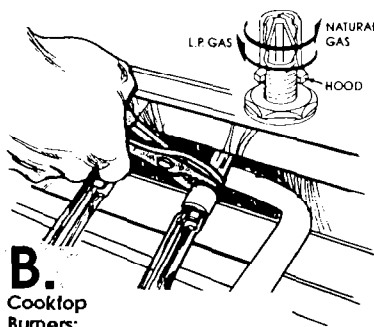
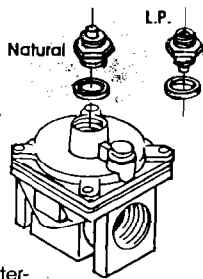

B. Cooktop Burners:

Turn the orifices hood down until snug against pin. **DO NOT OVERTIGHTEN.** Adjust the air shutters for proper flame by sliding the air shutter to close or open the shutter as needed. See Panel C, Step 18 for electrical ignition systems or Step 19A for standing pilot systems.

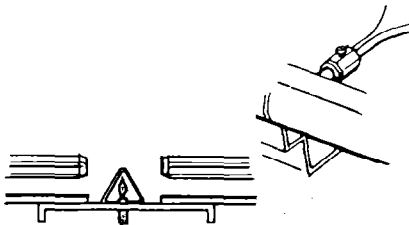

Cooktop burners with standing pilots require adjustment of pilot flame to 1/4" high. The adjustment control is located on the manifold pipe or at pilot flame base, depending on the model.

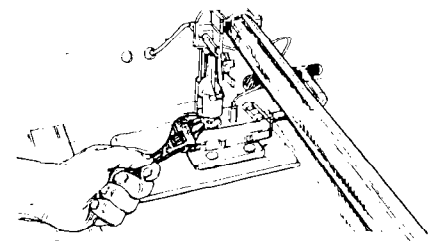

C. Oven Burner: Remove oven racks and lower panel from oven bottom. Turn the orifice hood down until snug against pin. **DO NOT OVERTIGHTEN.** The burner flame should be 1/2" long when air shutter is correctly adjusted. The air shutter slides to close or open the shutter as needed. See Panel C, Step 21 for electronic ignition systems, or Step 23A for standing pilot systems. Replace oven bottom and racks.

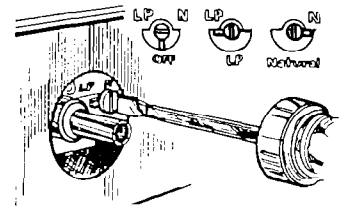

D. Oven thermostat: Remove thermostat knob, pulling straight off. Use a small screwdriver to rotate the key to L.P. Replace thermostat knob.

E. After all the burners have been converted to L.P. gas usage and gas line is connected, check for leaks. Use a brush and liquid detergent to test all gas connections for leaks. Bubbles around connections will indicate a leak. If a leak appears, shut off gas valve controls and wrench-tighten connections. Then check connections again. **NEVER TEST FOR GAS LEAKS WITH A MATCH OR OTHER FLAME.**

Part No. 76724-00/4320880
©1990 Whirlpool Corporation

Prepared by Whirlpool Corporation, Benton Harbor, Michigan 49022

Printed in U.S.A.

Free Manuals Download Website

<http://myh66.com>

<http://usermanuals.us>

<http://www.somanuals.com>

<http://www.4manuals.cc>

<http://www.manual-lib.com>

<http://www.404manual.com>

<http://www.luxmanual.com>

<http://aubethermostatmanual.com>

Golf course search by state

<http://golfingnear.com>

Email search by domain

<http://emailbydomain.com>

Auto manuals search

<http://auto.somanuals.com>

TV manuals search

<http://tv.somanuals.com>