

Use & Care

G U I D E

Self-Cleaning And Standard-Cleaning Electric Ranges

A Note to You	2
Range Safety	3-5
Getting to Know Your Range	6
Using Your Range	10
Using the Self- Cleaning Cycle	29
Caring for Your Range	32
Troubleshooting	42
Requesting Assistance or Service	44
Index	47
Warranty	48

1-800-44-ROPER

Call us with questions or comments.

MODELS FEP310E, FEP320E, FEP330E,
FES330E, FES364E

PART NO. 3196280 Rev. B

Download from www.Somanuals.com. All Manuals Search And Download.

ROPER[®]
Home Appliances

A NOTE TO YOU

Thank you for buying a ROPER® appliance.

Your ROPER range gives you all the functionality of name brand appliances at a value price. To ensure that you enjoy years of trouble-free operation, we developed this Use and Care Guide. It is full of valuable information about how to operate and maintain your appliance properly and safely. Please read it carefully.

Also, complete and mail the **Product Registration Card** provided with your appliance. The card helps us notify you about any new information on your appliance.

Please record your model's information.

Whenever you call to request service for your appliance, you need to know your complete model number and serial number. You can find this information on the model and serial number plate (see the diagrams on pages 6-9 for the location of the plate). Also, record the other information shown in the next column.

Model Number _____

Serial Number _____

Purchase Date _____

Dealer Name _____

Dealer Address _____

Dealer Phone _____

Keep this book and the sales slip together in a safe place for future reference.

Our Consumer Assistance Center number is toll-free.

1-800-44-ROPER
(1-800-447-6737)

RANGE SAFETY

Your safety is important to us.

This guide contains safety statements under warning symbols. Please pay special attention to these symbols and follow any instructions given. Here is a brief explanation of the use of the symbol.



This symbol alerts you to hazards such as fire, electrical shock, or other injuries.

IMPORTANT SAFETY INSTRUCTIONS

WARNING

To reduce the risk of fire, electrical shock, injury to persons, or damage when using the range, follow basic precautions, including the following:

General

- Read all instructions before using the range.
- Install or locate the range only in accordance with the provided Installation Instructions. The range must be installed by a qualified installer. The range must be properly connected to electrical supply and grounded.



- **WARNING:** To reduce the risk of tipping the appliance, the appliance must be secured by a properly installed anti-tip bracket. To check if the bracket is installed properly, see "The anti-tip bracket" on page 27.
- **CAUTION:** Do not store things children might want above the range. Children could be burned or injured while climbing on it.
- Do not leave children alone or unattended in area where the range is in use. They should never be allowed to sit or stand on any part of the range. They could be burned or injured.
- Do not operate the range if it is damaged or not working properly.

- Do not use the range for warming or heating the room. Persons could be burned or injured, or a fire could start.
- Use the range only for its intended use as described in this manual.



- Do not touch surface units, areas near units, heating elements, or interior surfaces of oven. Surface units and heating elements may be hot even though they are dark in color. Areas near surface units and interior surfaces of an oven become hot enough to cause burns. During and after use, do not touch or let clothing or other flammable materials contact surface units, areas near units, heating elements, or interior surfaces of oven until they have had sufficient time to cool. Other surfaces of the range, such as the oven vent opening, the surface near the vent opening, the cooktop, and the oven door, could also become hot enough to cause burns.

continued on next page



- Do not wear loose or hanging garments when using the range. They could ignite if they touch a hot surface unit and you could be burned.
- Use only dry pot holders. Moist or damp pot holders on hot surfaces could result in burns from steam. Do not let pot holder touch hot heating elements. Do not use a towel or bulky cloth for a pot holder. It could catch on fire.
- Keep range vents unobstructed.
- Do not heat unopened containers. They could explode. The hot contents could cause burns and container particles could cause injury.
- Use only cookware approved for oven use. Follow cookware manufacturer's instructions, especially when using glass or plastic cookware.
- Do not store flammable materials on or near the range. The fumes could create an explosion and/or fire hazard.

When using the cooktop

- Ceramic glass cooktop model: Do not cook on a broken cooktop. If the cooktop should break, cleaning solutions and spillovers could penetrate the broken cooktop and create a risk of electrical shock. Contact a qualified technician immediately.
- Coil element cooktop models: Make sure the reflector bowls are in place during cooking. Cooking without reflector bowls could subject the wiring and components underneath them to damage.

- Coil element cooktop models: Do not line reflector bowls with aluminum foil or other liners. Improper installation of these liners could result in a risk of electric shock or fire.
- Select a pan with a flat bottom that is about the same size as the surface unit. If pan is smaller than the surface unit, some of the heating element will be exposed and could result in the igniting of clothing or pot holders. Correct pan size also improves cooking efficiency.
- Check to be sure glass cookware is safe for use on the range. Only certain types of glass, glass-ceramic, ceramic, earthenware, or other glazed cookware are suitable for cooktops without breaking due to the sudden change in temperature.
- Never leave surface units unattended at high heat settings. A boilover could result and cause smoking and greasy spillovers that could ignite.

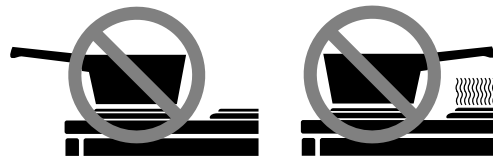

- Turn pan handles inward, but not over other surface units. This will help reduce the chance of burns, igniting of flammable materials, and spills due to bumping of the pan.

When using the oven

- Always position oven rack(s) in desired location while oven is cool. If a rack must be removed while oven is hot, do not let pot holder contact hot heating elements in oven.
- Use care when opening oven door. Let hot air or steam escape before removing or replacing food.



Grease

- Grease is flammable. Do not allow grease to collect around cooktop or in vents. Wipe spillovers immediately.



- Do not use water on grease fires. Never pick up a flaming pan. Smother flaming pan on range by covering with a well-fitting lid, cookie sheet, or flat tray. Flaming grease outside of pan can be extinguished with baking soda or, if available, a multipurpose dry chemical or foam-type extinguisher.
- Do not use oven cleaners. No commercial oven cleaner or oven liner protective coating of any kind should be used in or around any part of the oven.
- Before self-cleaning the oven, remove broiler pan, broiler grid, oven racks, and other cookware. Do not use your oven to clean miscellaneous parts unless you are instructed to do so in this Use and Care Guide.
- Coil element cooktop models: Do not soak removable heating elements in water. The elements will be damaged and shock or fire could result.
- Ceramic glass cooktop model: Clean cooktop with care. Some cleaners could produce noxious fumes if applied to a hot surface. If a wet soft cloth is used to wipe spills on a hot cooking area, be careful to avoid steam burns.
- Do not clean door heat seal. It is essential for a good seal. Care should be taken not to rub, damage, or move the seal. Clean only parts recommended in this Use and Care Guide.
- Do not repair or replace any part of the range unless specifically recommended in this manual. All other servicing should be referred to a qualified technician.
- Disconnect the electrical supply before servicing the range.

Care and cleaning

- Small amounts of formaldehyde and carbon monoxide are given off in the Self-Cleaning cycle from fiberglass insulation and food decomposition. Significant exposure to these substances could cause cancer or reproductive harm. Exposure can be minimized by venting with a hood or open window and wiping out excess food spills prior to self-cleaning.

– SAVE THESE INSTRUCTIONS –

GETTING TO KNOW YOUR RANGE

This section contains captioned pictures of your range. Use them to learn where all parts and features are and what they look like. Use the page references to help you quickly find out more about the part or feature you are interested in.

(Model FES364E shown)

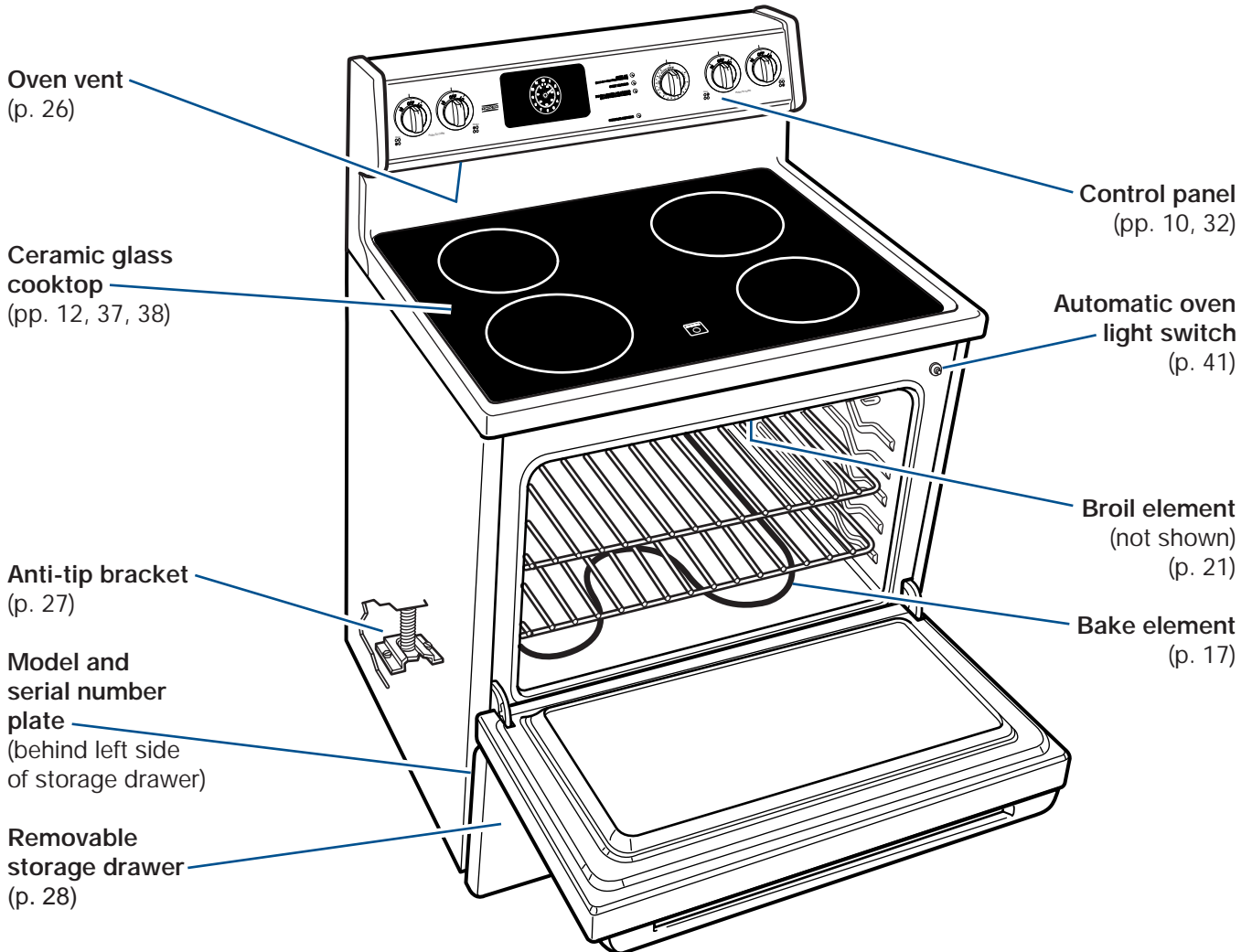

CONTROL PANEL

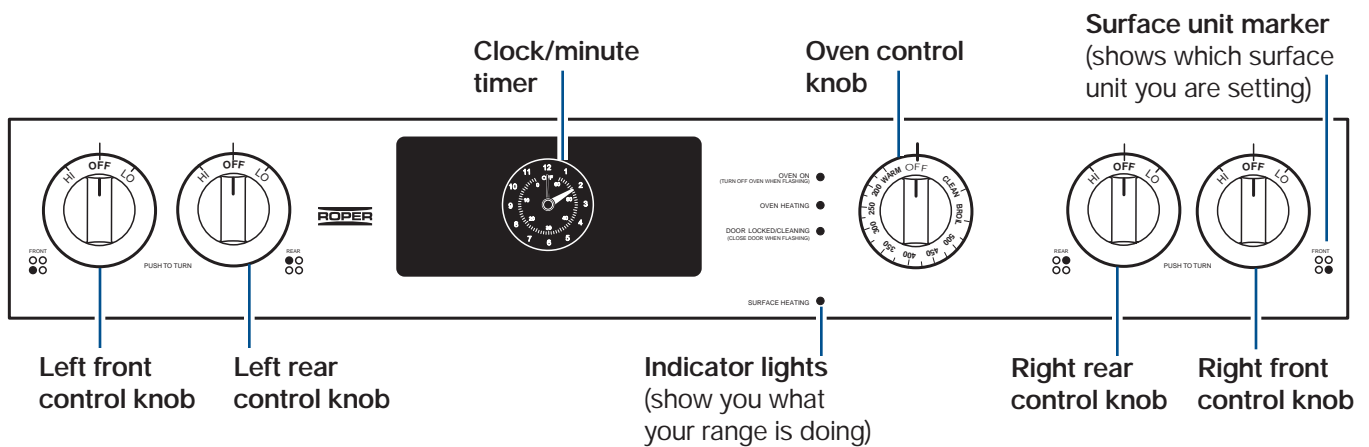

(Model FES330E shown)

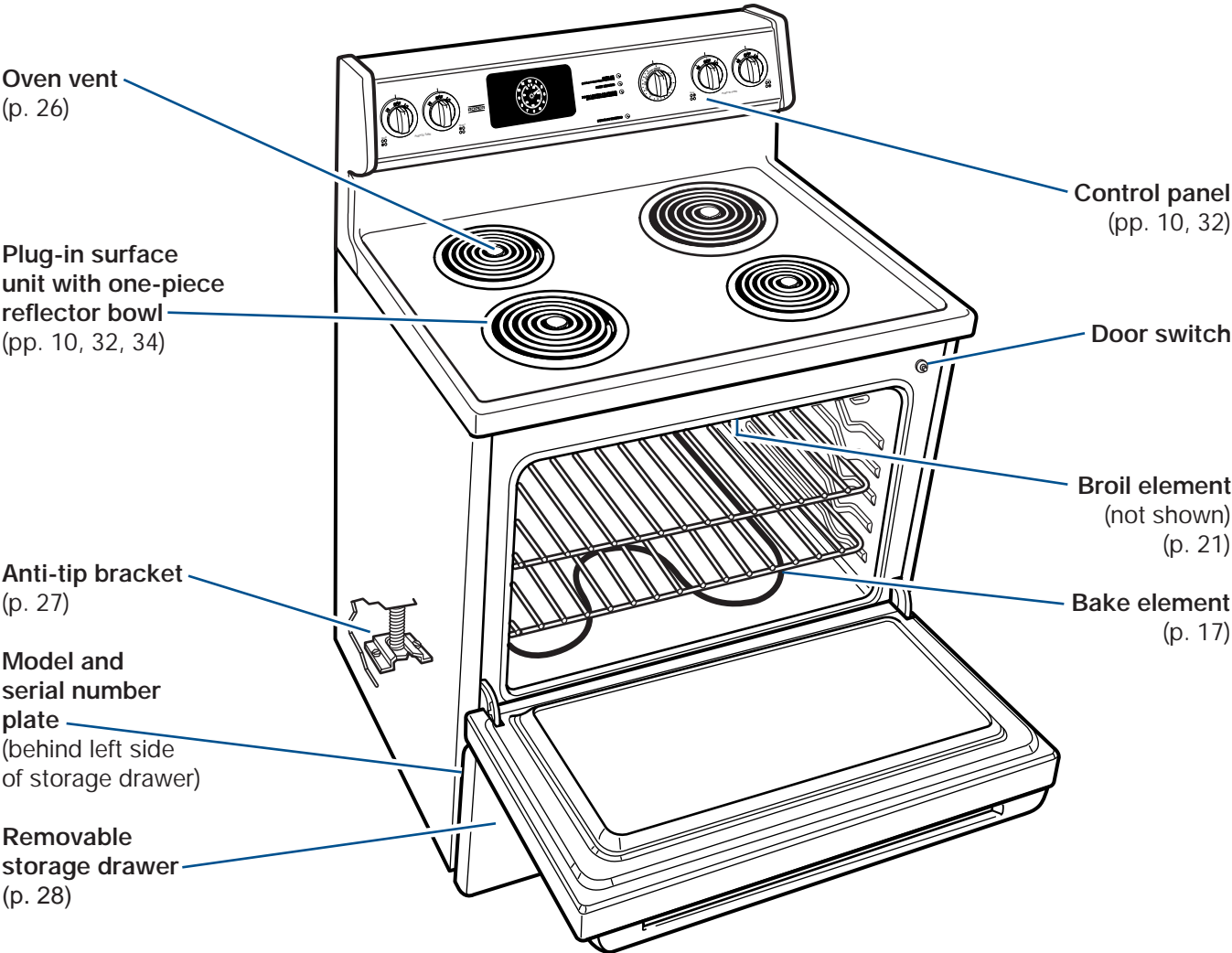

CONTROL PANEL

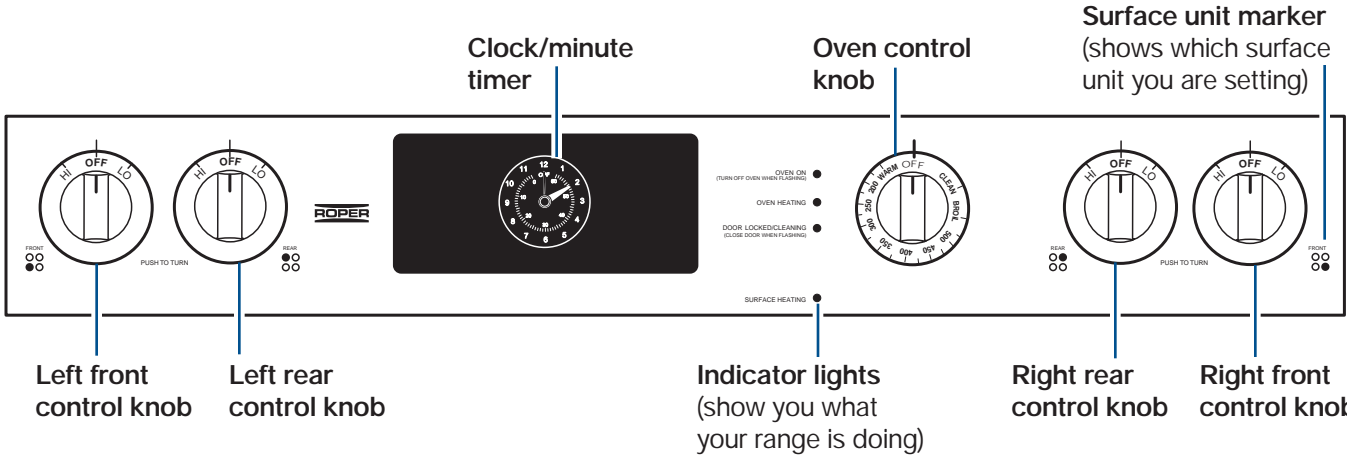

GETTING TO KNOW YOUR RANGE

(Model FEP330E shown)

Oven vent
(p. 26)

Plug-in surface unit with one-piece reflector bowl
(pp. 10, 32, 34)

Anti-tip bracket
(p. 27)

Model and serial number plate
(behind left side of storage drawer)

Removable storage drawer
(p. 28)

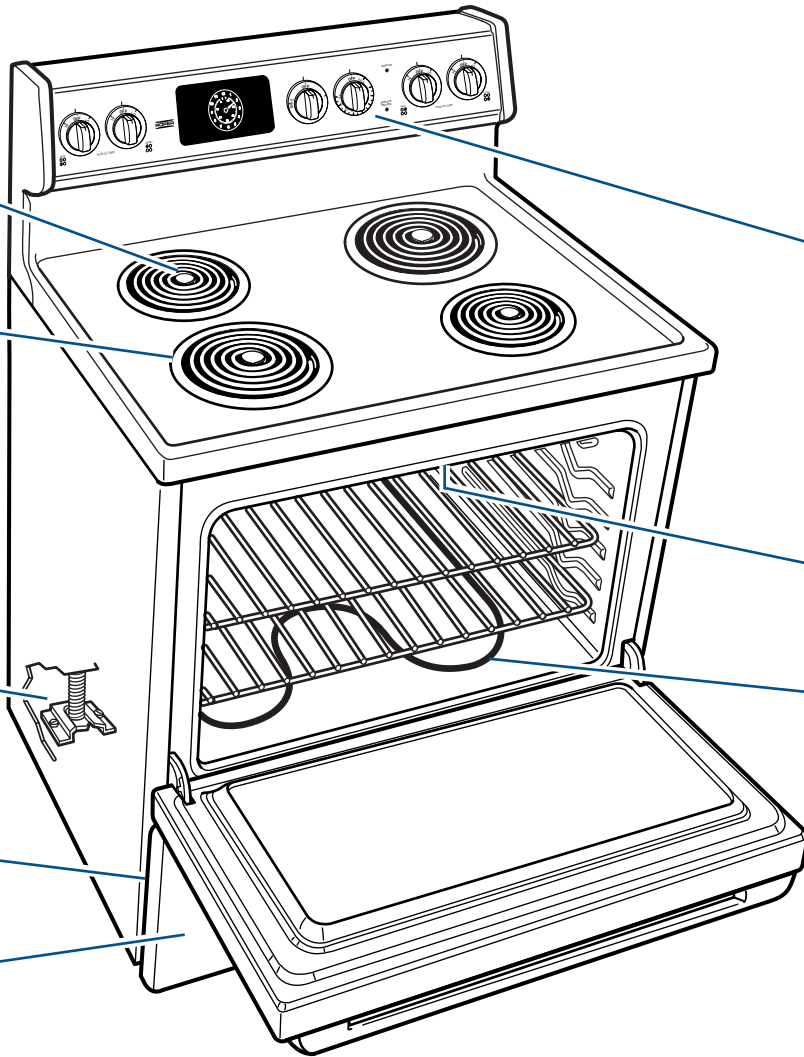

Control panel
(pp. 10, 32)

Broil element
(not shown)
(p. 23)

Bake element
(p. 18)

CONTROL PANEL

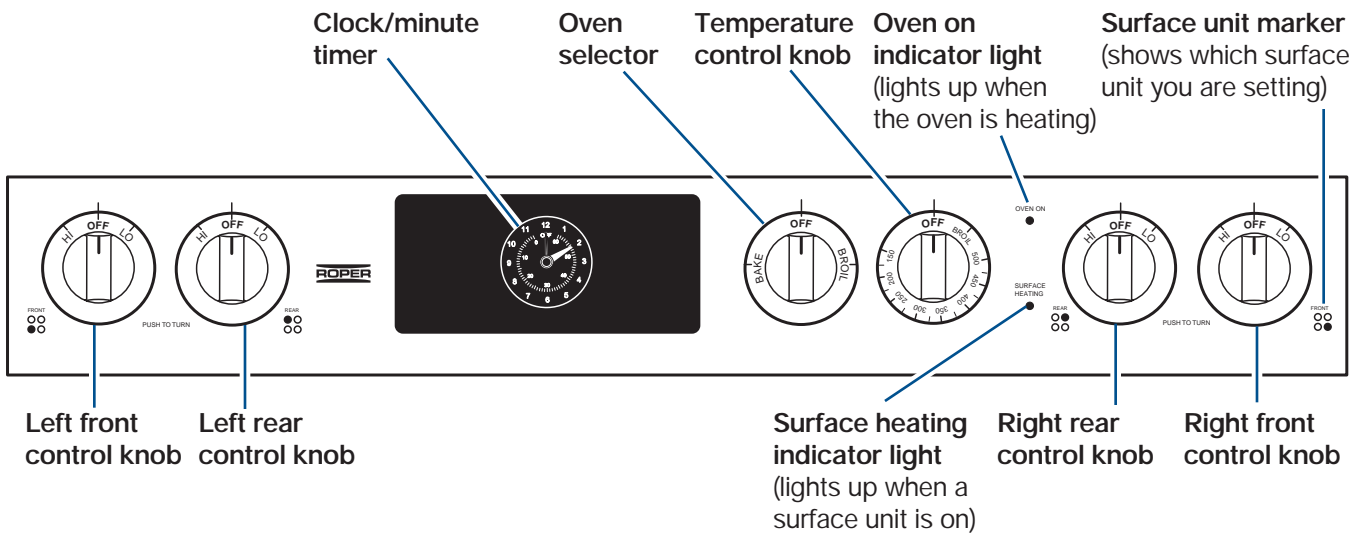

(Models FEP310E and FEP320E shown)

Oven vent (p. 26)

Plug-in surface unit with one-piece reflector bowl (pp. 10, 32, 34)

Anti-tip bracket (p. 27)

Model and serial number plate (behind left side of storage drawer)

Removable storage drawer (p. 28)

Control panel (pp. 10, 32)

Broil element (not shown) (p. 23)

Bake element (p. 18)

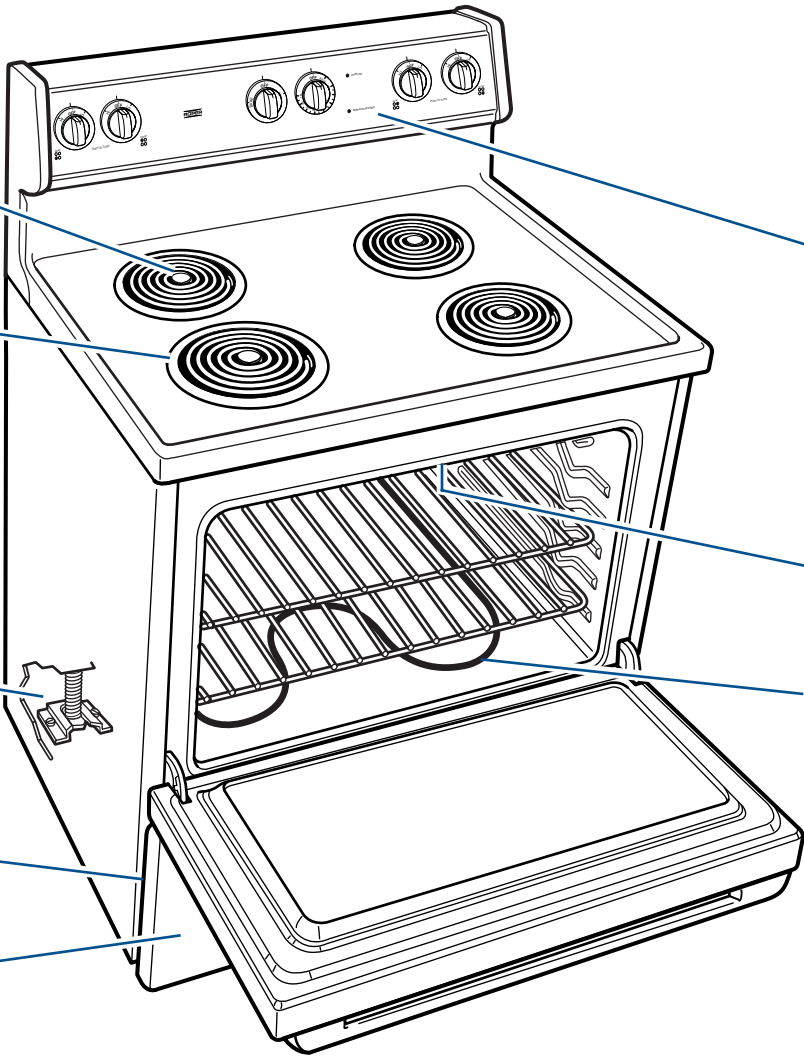

CONTROL PANEL

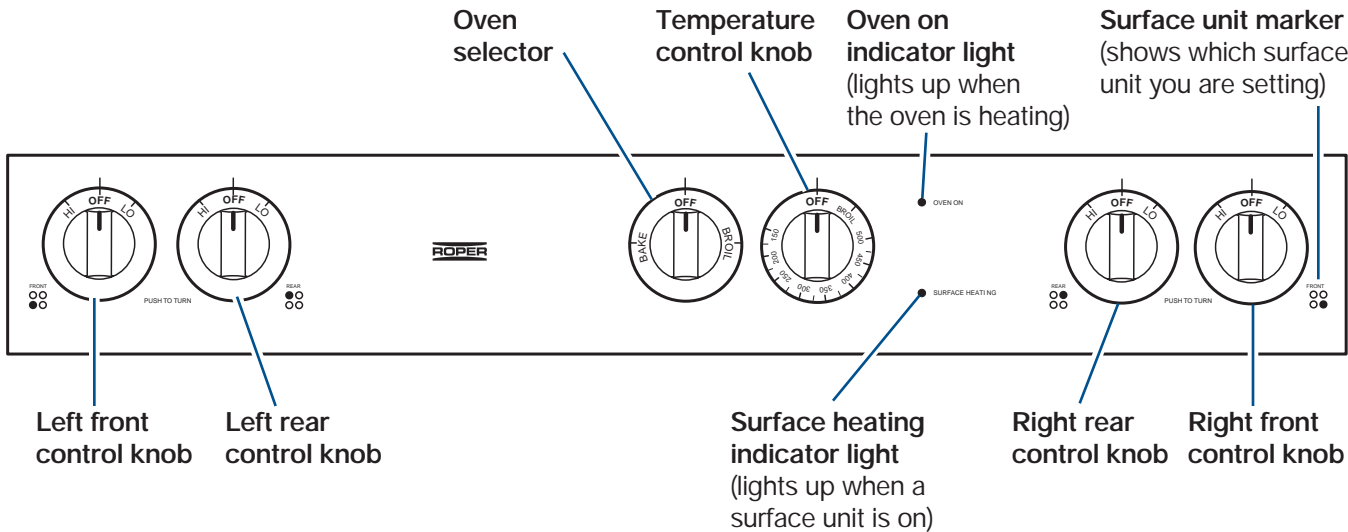

USING YOUR RANGE

To get the best cooking results, you should use your range the correct way. This section tells you what you need to know to use your range safely and efficiently.

USING THE SURFACE UNITS

Using the control knobs

Push in the control knobs before turning them to a setting. You can set them anywhere between HI and OFF.

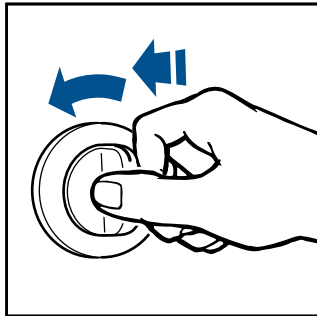

Surface unit heat settings

Use the following chart as a guide.

SETTING	RECOMMENDED USE
HI	<ul style="list-style-type: none">To start foods cooking.To bring liquids to a boil.
Medium High	<ul style="list-style-type: none">To hold a rapid boil.To fry chicken or pancakes.
Medium	<ul style="list-style-type: none">For gravy, pudding, and icing.To cook large amounts of vegetables.
Medium Low	<ul style="list-style-type: none">To keep food cooking after starting it on a higher setting.
LO	<ul style="list-style-type: none">To keep food warm until it's ready to serve.

! WARNING



Fire Hazard

Turn all controls off when done cooking. Failure to do so can result in death, fire, or burns.

Energy saving tips

- Match the pan to the surface unit size.
- The pan should have a flat bottom, straight sides, and a well-fitting lid.
- To help shorten your cooking time, use the least amount of liquid possible.
- Preheat your pans only when recommended and for the shortest time possible.
- Start your food on a higher heat setting, then turn the control to a lower setting to finish cooking.
- Place a filled pan on the surface unit before turning it on.
- Coil element models: Keep your reflector bowls clean for best heat reflection.

USING THE SURFACE UNITS (CONT.)

Cookware tips

- Use the correct cookware to prevent damage to the surface unit, cooktop, wiring, and surrounding areas.
- If the cookware is too small for the surface unit or the bottom is not flat, the surface unit could stay glowing red for an extended length of time causing damage to the unit.
- If you start cooking on high, it is important to turn the control down to a lower setting to complete cooking.
- The surface unit could overheat or be damaged if a pot has boiled dry or has been left empty on a hot surface unit.
- Flat bottomed cookware, including woks, canners, and teakettles, will provide better contact with the surface unit and provide the best cooking results.
- Warped, dented, and ribbed-bottomed cookware can result in uneven cooking due to incomplete contact with the surface unit.
- Cookware that has been designed with slightly indented bottoms or small expansion channels can be used.
- Choose medium to heavy gauge (thickness) cookware.
- The pan material (type of metal or glass) affects how quickly and evenly the pan heats.

Home canning information

To protect your range:

- Use flat-bottomed canners/pans for best results.
- Use the largest surface unit for best results. Also,

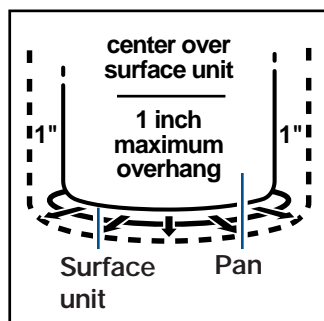

use a canner/pan that you can center over the surface unit and that does not extend more than one inch outside the surface unit area. Large diameter canners/pans, if not centered correctly, trap heat and can cause damage to the cooktop.

- Do not place your canner on 2 surface units at the same time. Too much heat will buildup and will damage the cooktop.

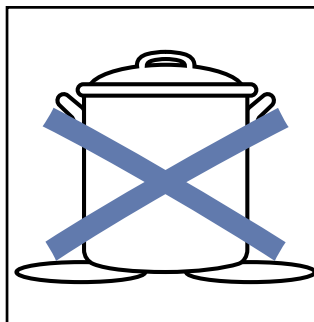

Too much heat will buildup and will damage the cooktop.

- Start with hot water. This reduces the time the control is set on high. Reduce the heat setting to the lowest position needed to keep water boiling.

- To keep your elements working for as long as possible:
 - Prepare small batches at a time.
 - Do not use your elements for canning all day.
- On coil element models, keep your reflector bowls clean so that they will always reflect heat well.
- Refer to your canner manual for specific instructions.

Optional canning kit

(Coil element models)

Most water-bath or pressure canners have large diameters. If you do canning with them at high heat settings for long periods of time, you can shorten the life of regular surface units. This can also damage the cooktop. If you plan to use the cooktop for canning, we recommend the installation of a Canning Kit. Order the kit (Part No. 242905) from your Roper dealer or authorized Roper service company.

USING THE SURFACE UNITS (CONT.)

Using the ceramic glass cooktop

(Ceramic glass cooktop model)

Cooking on the ceramic glass cooktop is similar to cooking on coil surface units. There are, however, a few differences:

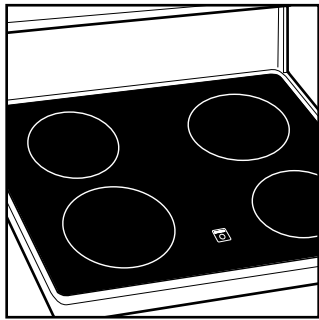

- The cooking surface area will glow red when the element is turned on. You will see the element cycling on and off – even on the HI setting – to help the area stay at the

temperature setting you chose.

- Do not cook foods directly on the cooktop.
- Do not cook popcorn that comes in prepackaged aluminum containers on the cooktop. The container could leave aluminum marks on the cooktop that cannot be removed completely.
- Lift pots and pans onto and off of the cooktop. Sliding pots and pans on the cooktop could leave marks that are difficult to remove or could leave permanent marks.
- Dropping a heavy or hard object on the cooktop could crack it. Be careful when using heavy skillets and large pots. Do not store jars or cans above the cooktop.

- Do not use the cooktop as a cutting board.
- Do not allow anything that could melt, such as plastic or aluminum foil, to come in contact with the cooktop while it is hot.
- Sugary spills and soils can cause pitting. See page 37 for more information.
- Wiping off the cooktop before and after each use will help keep the surface free from stains and give you the most even heating. See pages 37 and 38 for care and cleaning suggestions.

Cookware tips

- Check for rough spots on the bottom of your metal or glass cookware which could scratch the ceramic surface.
- Make sure the bottoms of pots and pans are clean and dry before using them. Food and water particles left on the bottoms can leave deposits on the cooktop when it is heated.

NOTE: Do not leave empty cookware, or cookware which has boiled dry, on a hot surface unit. The cookware could overheat and damage itself or the surface unit.

Hot surface indicator light

(Ceramic glass cooktop model)

The Hot Surface Indicator Light on the cooktop will



glow when a surface unit becomes too hot to touch. The Indicator Light will continue to glow as long as the surface unit is too hot to touch, even after it is turned off.

POSITIONING RACKS AND PANS

General guidelines

Follow this section carefully to get the best cooking results.

- Before turning on the oven, place oven racks where you need them.
- To move a rack, pull it out to the stop, raise the front edge, and lift it out.
- Be sure the rack(s) is level.
- Use pot holders or oven mitts to protect your hands if rack(s) must be moved while the oven is hot.
- When baking/roasting with 1 rack, place the rack so the top of the food will be centered in the oven.
- When baking/roasting on 2 racks, arrange the racks on the 2nd and 4th rack guides from the bottom.
- Do not place items on the oven door when it is open.

Using insulated bakeware, ovenproof glassware, and dark metal pans

- When baking with insulated cookie sheets or baking pans, place them in the bottom third of the oven. You may need to increase the recommended baking times, so test for doneness before removing from the oven.
- When using ovenproof glassware or dark bakeware, reduce the oven temperature by 25°F but use the same baking time. Because these pans absorb heat, producing darker bottom browning and crispier crusts, place the rack in the center of the oven. When baking pies and bread, you can use the temperature suggested in the recipe.

Rack placement for specific foods:

FOOD	RACK POSITION
Frozen pies, large roasts, turkeys, angel food cakes	1st or 2nd rack guide from bottom
Bundt cakes, most quick breads, yeast breads, casseroles, meats	2nd rack guide from bottom
Cookies, biscuits, muffins, cakes, nonfrozen pies	2nd or 3rd rack guide from bottom

NOTE: For information on where to place your rack when broiling, see "Broiling guide" on page 25.

FOR BEST AIR CIRCULATION

Hot air must circulate around the pans in the oven for even heat to reach all parts of the oven. This results in better baking.

- Place the pans so that one is not directly over the other.
- For best results, allow 1½-2 inches of space around each pan and between pans and oven walls.
- Use only one cookie sheet in the oven at a time.

Where to place pans:

WHEN YOU HAVE	PLACE
1 pan	In center of the oven rack.
2 pans	Side by side or slightly staggered.
3 or 4 pans	In opposite corner on each oven rack. Stagger pans so no pan is directly over another.

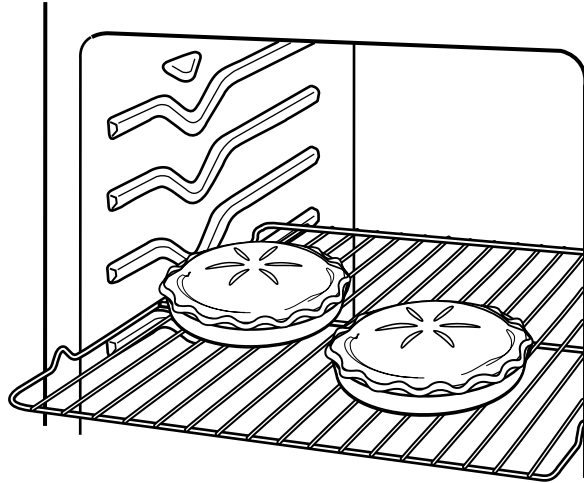

USING ALUMINUM FOIL FOR BAKING

Use aluminum foil to catch spillovers from pies or casseroles:

- Place the foil on the oven rack below the rack with the food. Turn up the foil edges and make sure the foil is about 1 inch larger all around than the dish holding the food.
 - Do not cover the entire rack with aluminum foil. It will reduce air circulation and give you poor cooking results.

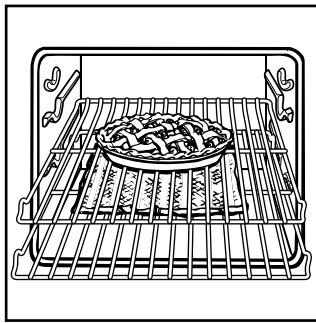

- Do not line the oven bottom or the entire oven rack with foil or other liners. It could affect the quality of your baking.

SETTING THE CLOCK (MODELS FEP330E, FES330E, FES364E)

1. Push in the minute timer knob and turn it clockwise until the clock shows the correct time of day.

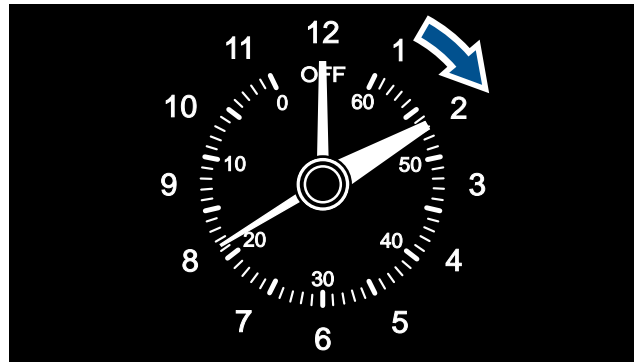

2. Let the minute timer knob pop out. Turn it clockwise until the minute timer hand points to OFF.



USING THE MINUTE TIMER (MODELS FEP330E, FES330E, FES364E)

The Minute Timer does not start or stop the oven. It works like a kitchen timer. Set it in minutes up to an hour. You will hear a buzzer when the set time is up.

NOTE: Do not push in the knob when setting the Minute Timer. Pushing in and turning the minute timer knob changes the clock setting.

1. Without pushing it in, turn the minute timer knob counterclockwise until the timer hand passes the setting you want.

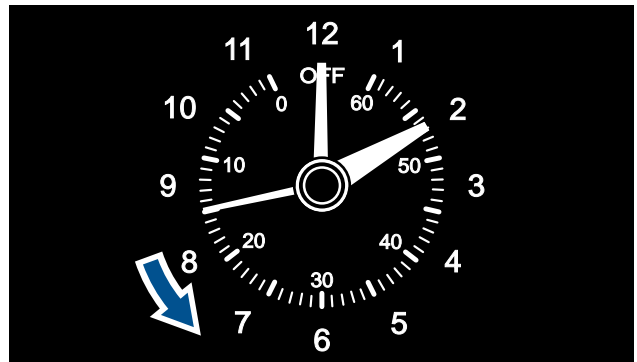

2. Without pushing it in, turn the knob back to the setting you want. When the time is up, a buzzer will sound. To stop the buzzer, turn the minute timer hand to OFF.



BAKING/ROASTING (MODELS FES330E AND FES364E)

1. Place the racks where you need them. For more information, see "Positioning racks and pans" on page 13.

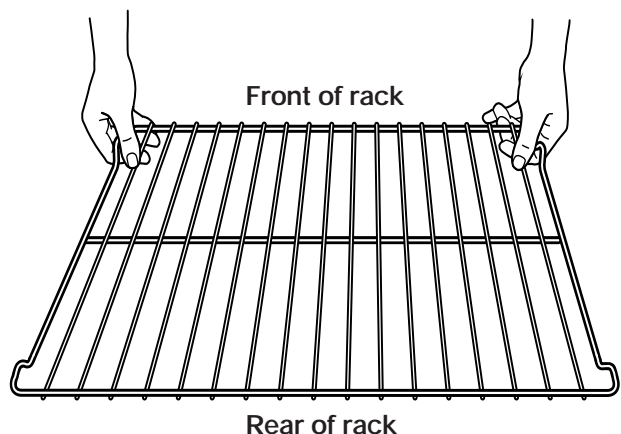

BAKING/ROASTING (MODELS FES330E AND FES364E) (CONT.)

2. Push and turn the oven control knob clockwise to the baking/roasting temperature you want.

NOTE: Do not preheat the oven when roasting.

PUSH AND TURN

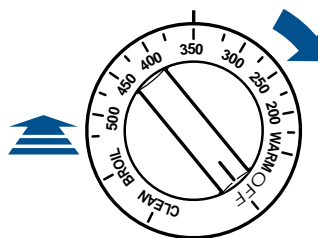

YOU SEE

OVEN ON and HEATING lights go on.

3. Put your food in the oven.

During baking/roasting, the elements will turn on and off to keep the oven temperature at the setting.

NOTE: The top element helps heat during baking/roasting, but does not turn red.

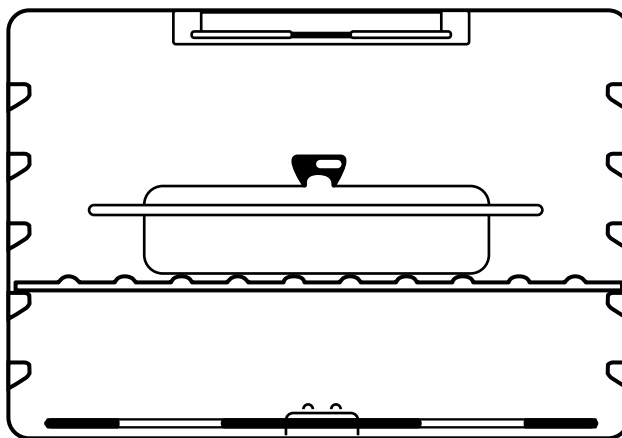

4. After baking/roasting, turn the oven control knob to OFF.

TURN

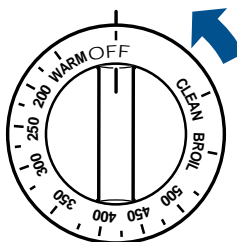

YOU SEE

OVEN ON and HEATING lights go out.

Roasting tips

- For even cooking, place the meat on a rack in a shallow pan. This keeps the meat out of the drippings and allows the heat to circulate better.
- Use a meat thermometer for the most accurate doneness. Insert it so the tip is in the center of the largest muscle or thickest portion of the meat or poultry. Make sure the thermometer is not touching bone, fat, or the bottom of the pan.

Energy saving tips

- "Oven peeking" can make cooking times longer and affect food quality.
- Rely on a timer to keep track of cooking time.
- Plan your meals for the most efficient use of the oven by cooking more than one food at a time.
- If possible, plan to bake while the oven is still hot after cooking.
- You don't have to preheat the oven when broiling or roasting.

BAKING/ROASTING (MODELS FEP310E, FEP320E, FEP330E)

1. Place the racks where you need them.
For more information, see "Positioning racks and pans" on page 13.

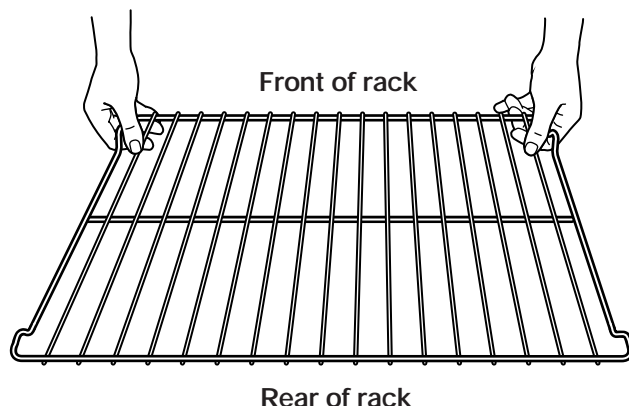

2. Set the oven selector to BAKE and the oven temperature control knob to the baking/roasting temperature you want.

The oven on indicator light will come on. The oven is preheated when the oven on indicator light first goes off.

NOTE: Do not preheat the oven when roasting.

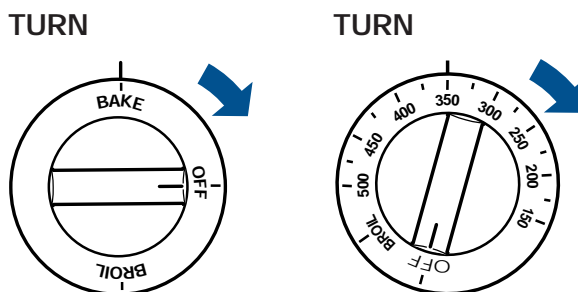

3. Put your food in the oven.

During baking/roasting, the elements will turn on and off to keep the oven temperature at the setting. The oven on indicator light will turn on and off with the elements.

NOTE: The top element helps heat during baking/roasting, but does not turn red.

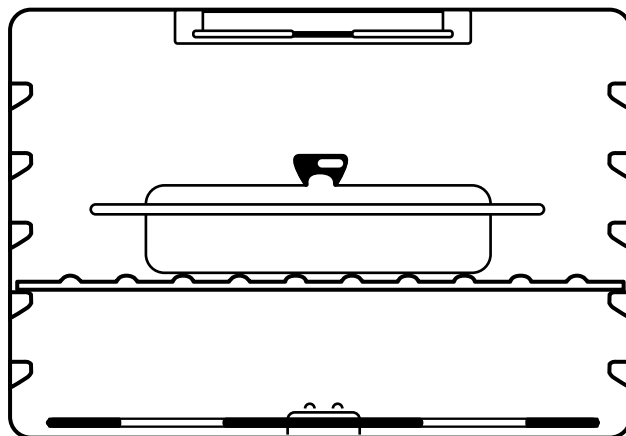

BAKING/ROASTING (MODELS FEP310E, FEP320E, FEP330E) (CONT.)

4. After cooking, turn off the oven.

Turn both the oven selector and the oven temperature control knob to OFF. The oven on indicator light will go off.

TURN

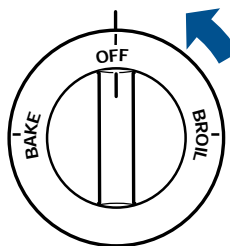

TURN

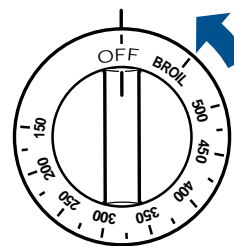

Roasting tips

- For even cooking, place the meat on a rack in a shallow pan. This keeps the meat out of the drippings and allows the heat to circulate better.
- Use a meat thermometer for the most accurate doneness. Insert it so the tip is in the center of the largest muscle or thickest portion of the meat or poultry. Make sure the thermometer is not touching bone, fat, or the bottom of the pan.

Energy saving tips

- "Oven peeking" can make cooking times longer and affect food quality.
- Rely on a timer to keep track of cooking time.
- Plan your meals for the most efficient use of the oven by cooking more than one food at a time.
- If possible, plan to bake while the oven is still hot after cooking.
- You don't have to preheat the oven when broiling or roasting.

ADJUSTING THE OVEN TEMPERATURE CONTROL

Although your new oven is properly adjusted to provide accurate temperatures, it may cook faster or slower than your old oven.

If you are not satisfied with the baking/roasting results, you can change the temperature calibration by following the steps below.

NOTE: DO NOT measure the oven temperature with a thermometer. Opening the oven door will lower the oven temperature and give you an incorrect reading. Also, the thermometer temperature reading will change as your oven cycles.

1. Make sure the oven temperature control knob is turned to the off position. Pull the knob straight off and flip it over.

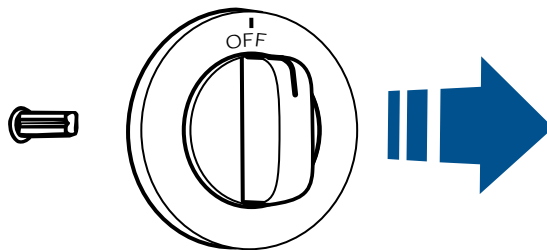

2. Loosen the locking screws inside the control knob. Note the position of the notches.

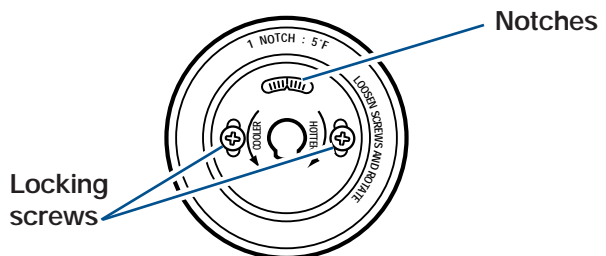

3. Adjust the temperature.
 - **To lower the temperature**, hold the knob handle firmly and turn the skirt **counterclockwise** to move the tooth a notch to the left.
 - **To raise the temperature**, hold the knob handle firmly and turn the skirt **clockwise** to move the tooth a notch to the right.

Each notch equals about 5°F.

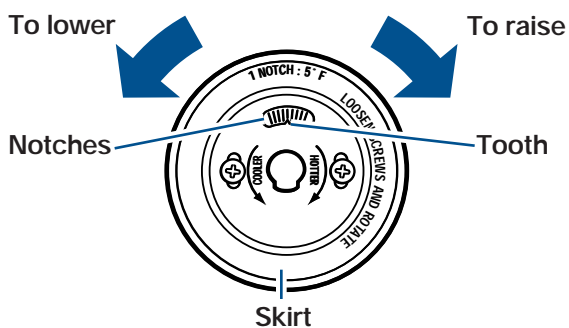

4. Tighten the locking screws and replace the control knob.

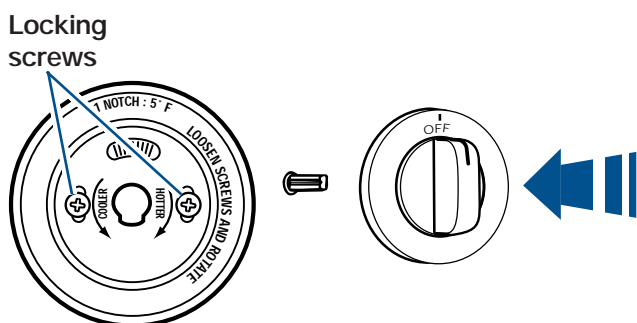

BROILING (MODELS FES330E AND FES364E)

NOTES:

- Do not preheat when broiling.
- Leave the door partly open whenever you use the oven to broil. This lets the oven stay at the proper temperatures.

1. Place the rack where you need it.

You need to place the rack so that the surface of the food is at least 3 inches away from the broil element. See "Broiling guide" on page 25.

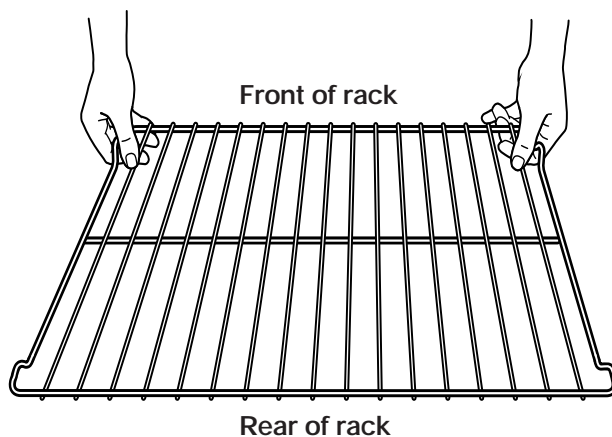

2. Put your food on the broiler pan and place the pan in the center of the oven rack.

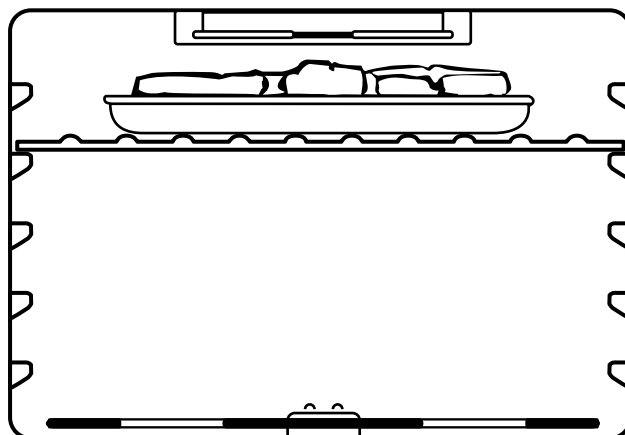

3. Close the door to the broil stop position.

The broil stop position lets the door stay open by itself about 5 inches.

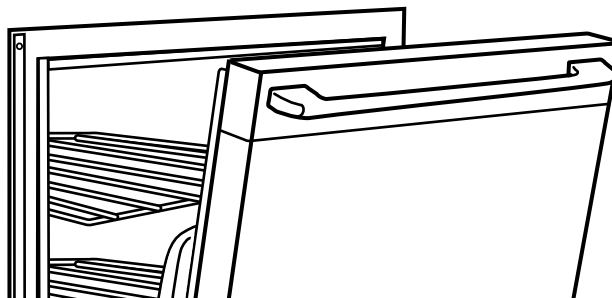

continued on next page

BROILING (MODELS FES330E AND FES364E) (CONT.)

4. Set the oven control knob to BROIL.

PUSH AND TURN

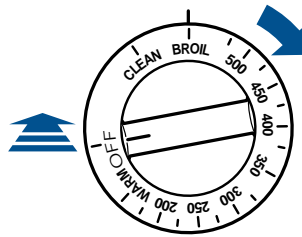

YOU SEE

OVEN ON and HEATING lights go on.

5. After broiling, turn the oven control knob to OFF.

TURN

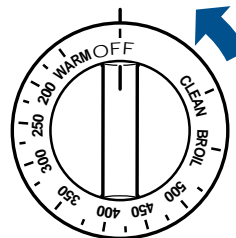

YOU SEE

OVEN ON and HEATING lights go out.

BROILING (MODELS FEP310E, FEP320E, FEP330E)

NOTES:

- Do not preheat when broiling.
- The oven selector must be on BROIL for broiling temperatures.
- Leave the door partly open whenever you use the oven to broil. This lets the oven stay at the proper temperatures.

1. Place the rack where you need it.

You need to place the rack so that the surface of the food is at least 3 inches away from the broil element. See "Broiling guide" on page 25.

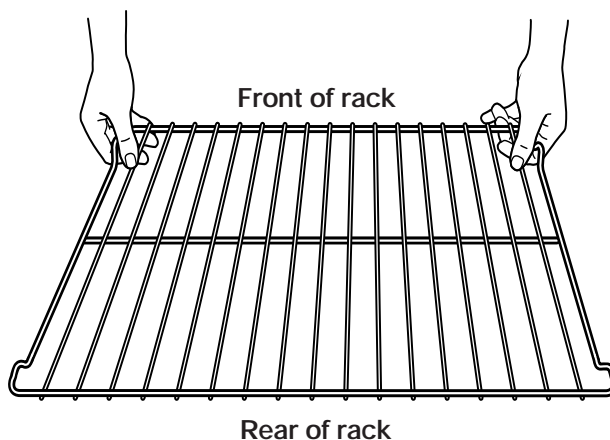

2. Put your food on the broiler pan and place the pan in the center of the oven rack.

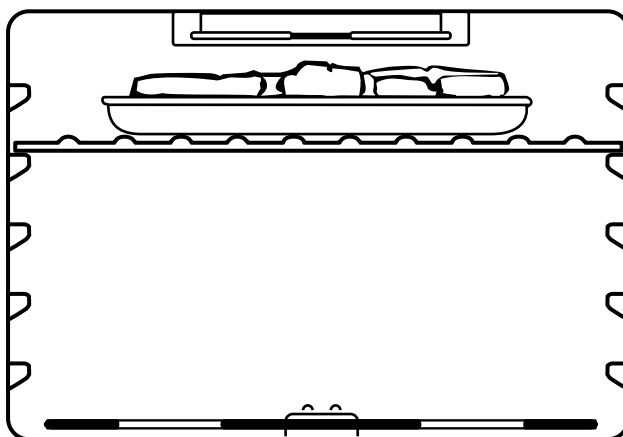

3. Close the door to the broil stop position.

The broil stop position lets the door stay open by itself about 5 inches.

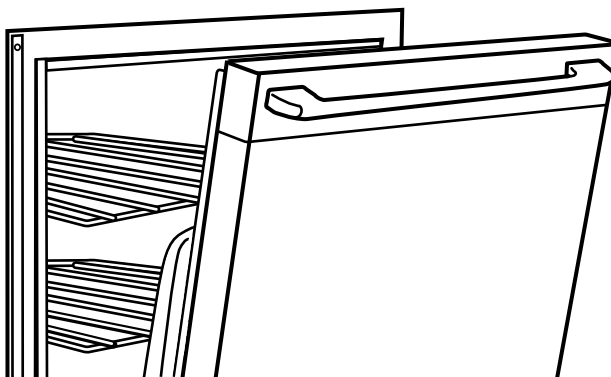

continued on next page

BROILING (MODELS FEP310E, FEP320E, FEP330E) (CONT.)

4. Set the oven selector and the oven temperature control knob to BROIL.
The oven on indicator light will come on.

TURN

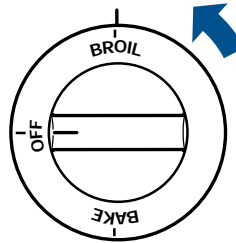

TURN

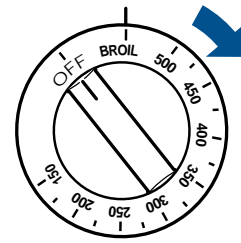

5. After broiling, turn off the oven.
Turn both the oven selector and the oven temperature control knob to OFF. The oven on indicator light will go off.

TURN

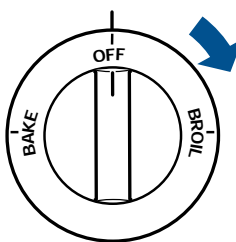

TURN

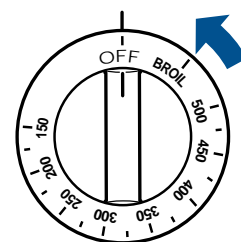

If you want to broil at a lower temperature:

- If your food is cooking too fast, turn the oven temperature control knob **counterclockwise** until the oven on indicator light goes off.
- If you want your food to broil slower from the start, set the oven temperature control knob between 170°F and 325°F. These temperature settings let the broil heating element cycle and slow cooking. The lower the temperature, the slower the cooking.

NOTE: Fish and chicken are some foods that may cook better if you use lower broiling temperatures.

TURN

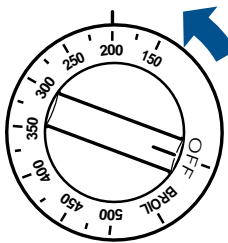

TURN

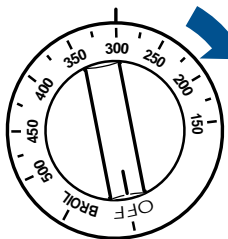

BROILING TIPS

- Use the broiler pan and grid for broiling. They are designed to drain extra liquid and grease away from the cooking surface. This drainage helps prevent spatter, smoke, or fire.
- Do not cover the broiler grid with foil.
- To make sure the grease drains well, do not use cookie sheets or similar pans for broiling.
- Place food about 3 inches or more from the broil element.
- After broiling, remove the broiler pan from the oven when you remove the food. Drippings will bake on the pan if you leave it in the heated oven.

Broiling guide

Recommended rack positions are numbered from the bottom (1) to the top (5). For best results, turn meat after approximately $\frac{2}{3}$ of the broiling time. Turn chicken pieces after approximately half of the broiling time. Very thin cuts, such as fish fillets, may not need to be turned at all. Lobster tails are not turned.

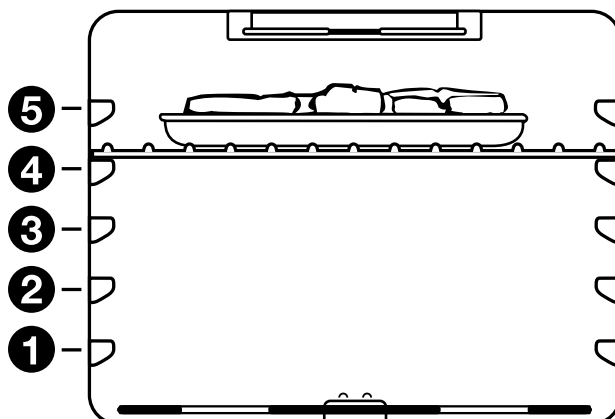

MEAT	RACK POSITION	APPROXIMATE TIME (MINUTES)	
		SIDE 1	SIDE 2
Steak, 1" thick	4		
medium rare		14-15	7-8
medium		15-16	8-9
well done		18-19	9-10
Hamburger Patties, 3/4" thick, 1/4 lb well done	4	13-14	7-8
Pork Chops, 1" thick	4	20-22	10-11
Ham Slice, 1/2" thick, precooked	4	8-10	4-5
Frankfurters	4	5-7	3-4
Lamb Chops, 1" thick	4	14-17	8-9
Chicken			
bone-in pieces	3	17-20	17-20
boneless breasts	4	11-16	11-16
Fish	4		
fillets 1/4-1/2" thick		8-10	4-5
steaks, 3/4-1" thick		16-18	8-9
Lobster Tails, 6-8 oz	3	17-20	N/A

Times are guidelines only and may need to be adjusted for individual tastes.

THE OVEN VENT (CERAMIC GLASS COOKTOP MODEL)

Hot air and moisture escape from the oven through a vent on the backguard below the control panel. The vent lets air circulate properly. Be careful not to block the vent, or you could get poor baking/roasting results.

⚠ WARNING



Burn Hazard
Use pot holders when touching items left near oven vent.
Failure to do so can result in burns.

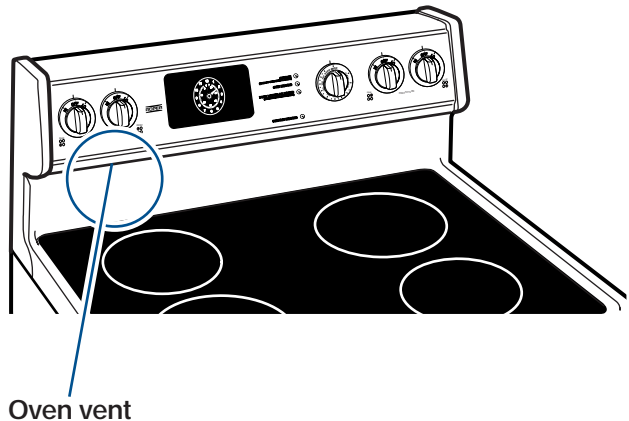

THE OVEN VENT (COIL ELEMENT MODELS)

⚠ WARNING



Fire Hazard
Use pot holders to move items left on the left rear surface unit.
Keep flammable materials away from the oven vent.
Failure to do so can result in death, fire, or burns.

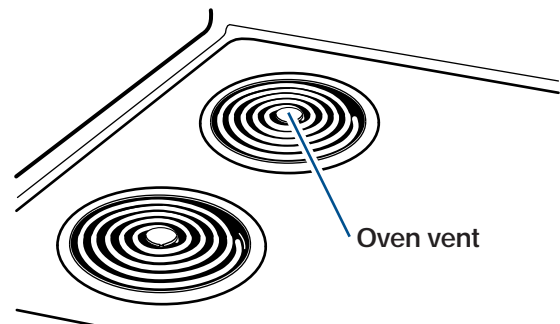

Hot air and moisture escape from the oven through a vent under the left rear surface unit. You can cook on this unit or keep food warm on it while the oven is on. The vent is needed for air circulation.

Do not block the vent by using extra large pans or covers. You will get poor baking/roasting results.

NOTE: Never leave plastic utensils over the vent. They could melt.

THE ANTI-TIP BRACKET

The range will not tip during normal use. However, the range can tip if you apply too much force or weight to the open door without the anti-tip bracket fastened down properly.

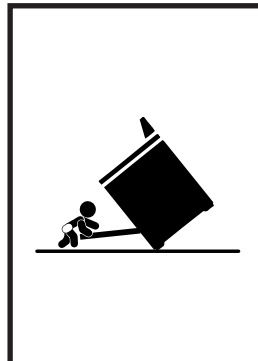

! WARNING

Tip Over Hazard

- Connect anti-tip bracket to the range.**
- Reconnect anti-tip bracket, if the range is moved.**
- Do not push down on the open oven door.**
- Follow the Installation Instructions.**
- Do not let children climb onto the oven door.**
- Failure to follow these instructions can result in death, burns, or other injury.**

To make sure the anti-tip bracket is fastened into place:

- Remove the storage drawer (see "The storage drawer" on page 28).
- Look under the range (you may need a flashlight). Check that a leveling leg is positioned under the bracket.
- See the Installation Instructions for further details.

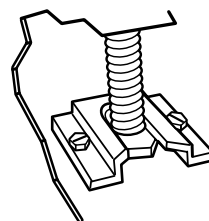

THE STORAGE DRAWER

You can remove the storage drawer to make it easier to clean under your range and to make sure the anti-tip floor bracket is installed. **Be careful when handling the drawer.**

Removing the storage drawer:

1. Empty the drawer before you remove it. Pull the drawer straight out to the first stop. (The stops are small, round objects formed in the slide rail. They keep the drawer from sliding all the way out.) Then lift the front of the drawer and pull it out to the second stop.
2. Lift the back of the drawer slightly and slide it all the way out.

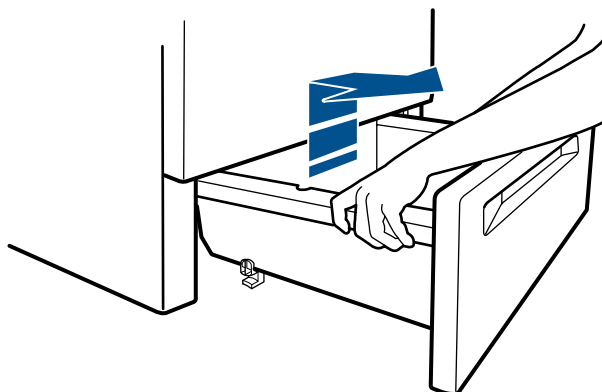

Replacing the storage drawer:

1. Fit the ends of the drawer slide rails into the drawer guides on both sides of the opening. Also, be sure the lower guide is fitted onto the lower slide rail.
2. Lift the front of the drawer and push it in until the metal stops on the drawer slide rails clear the drawer guides. Then slide the drawer closed.

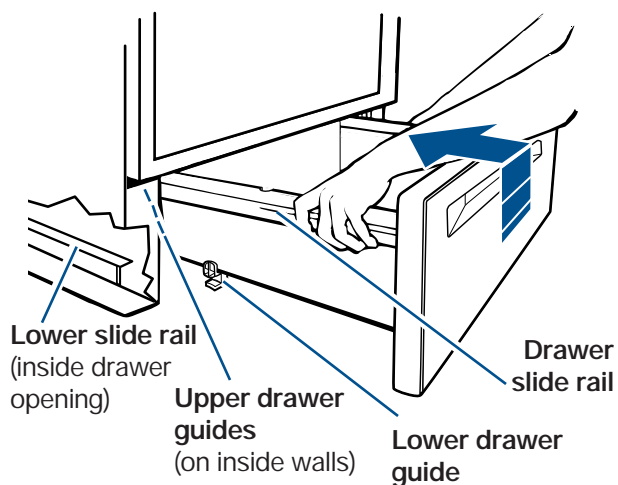

USING THE SELF-CLEANING CYCLE

(MODELS FES330E AND FES364E)

The Self-Cleaning cycle saves you from the toil and mess that often come with hand-cleaning the inside of the oven. Like the other functions of your range, you run the Self-Cleaning cycle with the easy-to-use controls. Please review the instructions in this section to keep your oven spotless.

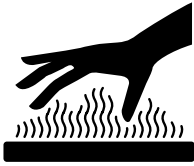

! WARNING

Burn Hazard

- Do not touch the oven during the Self-Cleaning cycle.
- Keep children away from oven during Self-Cleaning cycle.
- Do not use commercial oven cleaners in your oven.
- Failure to follow these instructions can result in burns, or illness from inhaling dangerous fumes.

BEFORE YOU START

Before you start the Self-Cleaning cycle, make sure you:

- Hand-clean the areas shown. They do not get hot enough during the Self-Cleaning cycle for soil to burn away. Use hot water and detergent or a soapy, steel-wool pad for cleaning.
NOTE: DO NOT clean, move, or bend the seal. You may get poor cleaning, baking, and roasting.
- Remove the broiler pan and grid and any pots and pans being stored in the oven.
- Wipe out any loose soil or grease. This will help reduce smoke during the Self-Cleaning cycle.
- Wipe up food spills containing sugar as soon as possible after the oven cools down. When sugar is heated to a high temperature in the Self-Cleaning cycle, the high temperature can cause the sugar to burn and react with the porcelain. This can cause staining and etching or pitting.
- Remove the oven racks from the oven if you want them to remain shiny. You can clean the oven racks in the Self-Cleaning cycle, but they will become harder to slide. (See page 33.) If you clean the racks in the Self-Cleaning cycle, place them on the 2nd and 4th rack guides. (The guides are counted from bottom to top.)
- Heat and odors are normal during the Self-Cleaning cycle. Keep the kitchen well ventilated by opening a window or by turning on a vent hood or other kitchen vent during the cycle.

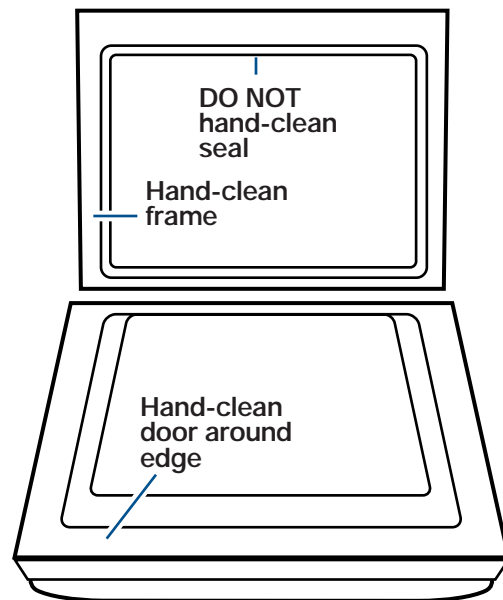

TIPS:

- Do not block the vent during the Self-Cleaning cycle. Air must move freely for best cleaning results.
- Do not leave plastic utensils on the cooktop. They may melt.
- Do not leave any foil in the oven during the Self-Cleaning cycle. Foil could burn or melt and damage the oven surface.

SETTING THE CONTROLS

1. Set the oven control knob to CLEAN.

The door will lock itself. If the door has a problem locking, it will try to lock itself every 12 seconds for 1 minute. If the door fails to lock, the Self-Cleaning cycle will cancel. The Self-Cleaning cycle will last 4 hours, 30 minutes.

PUSH AND TURN

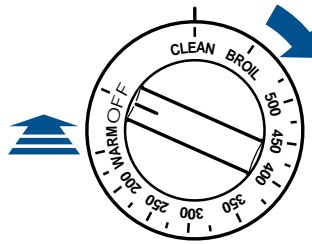

YOU SEE

OVEN ON light goes on. DOOR LOCKED/CLEANING light flashes until you close door, then is solid. HEATING light goes on when oven starts heating.

2. During the last 30 minutes of the Self-Cleaning cycle the oven will start to cool down.

Once the oven goes below the locked temperature:

YOU SEE

OVEN ON and DOOR LOCKED/CLEANING lights are on. HEATING light goes off.

YOU SEE

OVEN ON light flashes. DOOR LOCKED/CLEANING light goes out when door unlocks.

3. Turn the oven control knob to OFF.

TURN

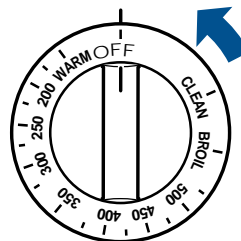

YOU SEE

OVEN ON light goes out.

4. After the oven is cool, wipe off any residue or ash with a damp cloth or sponge.

If needed, touch up spots with a mild abrasive cleanser or cleaning sponge.

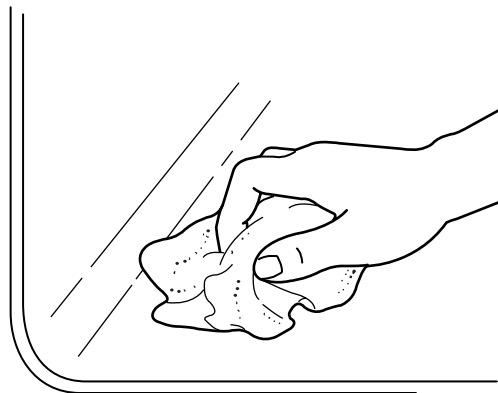

SETTING THE CONTROLS (CONT.)

To stop the self-cleaning cycle at any time:

Turn the oven control knob to OFF.

TURN

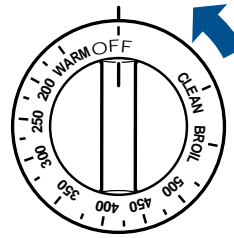

YOU SEE

DOOR LOCKED/
CLEANING light
stays on until oven
goes below locking
temperature.

Self-cleaning tips

- Keep the kitchen well ventilated during the Self-Cleaning cycle to help get rid of heat, odors, and smoke.
- Clean the oven before it gets heavily soiled. Cleaning a very soiled oven takes longer and could cause an increased amount of smoke.

HOW THE CYCLE WORKS

The Self-Cleaning cycle uses very high heat to burn away soil and grease. During the cycle, the oven gets much hotter than it does for normal baking or broiling. This high heat breaks up the soil or grease and burns it away.

Your oven is automatically preset for a 4½-hour Self-Cleaning cycle.

The graph at the right shows you what happens in a 4½-hour Self-Cleaning cycle. Notice that the heating stops ½ hour before the 4½-hour setting is up.

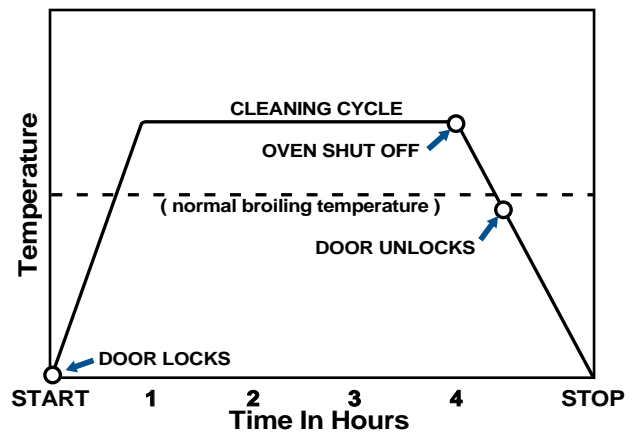

CARING FOR YOUR RANGE

Your range is designed so you can care for it easily. You can do most cleaning with items found around your home. Cleaning your range whenever spills or soiling occurs will help to keep it looking and working like new.



⚠️ WARNING

Explosion Hazard

Do not store flammable materials such as gasoline near the cooktop. Doing so can result in death, explosion, fire, or burns.

CLEANING CHART

Use this chart to get specific information on cleaning your range. **Before cleaning, always make sure all controls are off and the range is cool.**

PART	HOW TO CLEAN
Control knobs	<ol style="list-style-type: none">1. Turn the knobs off and pull them straight away from the control panel.2. Wash the knobs with a sponge and warm, soapy water. Rinse and dry them well. Do not soak them. Do not use steel wool or gritty cleansers, which can damage the finish of the knobs.3. Replace the knobs. Make sure all knobs are turned off.
Control panel	<ul style="list-style-type: none">• Wash the panel with a sponge and warm, soapy water. Wipe the panel with clean water and dry it well. Do not use steel wool or gritty cleansers, which can damage the finish. <p>OR</p> <ul style="list-style-type: none">• Wash the panel with a paper towel and spray glass cleaner. Do not spray the cleaner directly on the panel. Apply the cleaner to the paper towel.
Exterior surfaces (other than ceramic glass cooktop and control panel)	<ul style="list-style-type: none">• Wash with a sponge and warm, soapy water. Wipe with clean water and dry well.• Use a nonabrasive, plastic scrubbing pad on heavily soiled areas.• Do not use gritty or harsh cleansers, which can damage the finish. <p>NOTE: Do not let foods containing acids (such as vinegar, tomato, or lemon juice) remain on the surface. Acids may remove the glossy finish. Also wipe up milk or egg spills when the cooktop is cool. Be careful when cleaning around the model and serial number plate; too much scrubbing could remove the numbers.</p>
Surface units (Models FEP310E, FEP320E, FEP330E, FES330E)	<ul style="list-style-type: none">• You do not have to clean open coil elements because spatters or spills will burn off.• Do not immerse the surface units in water.
Chrome reflector bowls (Models FEP310E, FEP320E, FEP330E, FES330E)	<ul style="list-style-type: none">• Wash the reflector bowls with warm, soapy water and a nonabrasive, plastic scrubbing pad. Rinse and dry them well.• Clean the reflector bowls often.• Do not use gritty or harsh cleansers.• Do not clean the bowls in the Self-Cleaning oven.
Ceramic glass cooktop (Model FES364E)	<ul style="list-style-type: none">• See pages 37 and 38.

CLEANING CHART (CONT.)

PART	HOW TO CLEAN
Broiler pan and grid	<ul style="list-style-type: none"> Wash the pan and grid with a steel-wool pad and warm, soapy water. Rinse and dry well. Do not clean the pan and grid in the Self-Cleaning cycle (Models FES330E and FES364E). <p>OR</p> <ul style="list-style-type: none"> Wash the pan and grid in a dishwasher.
Oven racks	<ul style="list-style-type: none"> Wash with a steel-wool pad and warm, soapy water. Rinse and dry well. <p>OR</p> <ul style="list-style-type: none"> Leave the racks in the oven during the Self-Cleaning cycle (Models FES330E and FES364E). <p>NOTE: If you leave your racks in the oven during the Self-Cleaning cycle, they will lose their original color and become harder to slide. If you need to, apply a small amount of vegetable oil to the side rungs to make the racks easier to slide.</p>
Oven door glass (Models FEP320E, FEP330E, FES330E, FES364E)	<ul style="list-style-type: none"> Wash with a paper towel and spray glass cleaner or a nonabrasive plastic scrubbing pad and warm, soapy water. Wipe with clean water and dry well. Follow the directions that come with the cleaner.
Oven cavity (Models FEP310E, FEP320E, FEP330E)	<ul style="list-style-type: none"> Wash with a sponge or steel-wool pad and warm, soapy water. Wipe with clean water and dry well. <p>OR</p> <ol style="list-style-type: none"> Clean heavily soiled areas with a commercial oven cleaner. Follow the directions that come with the oven cleaner. (Place newspaper on the floor to protect the floor surface.) Wipe well with clean water. <p>NOTES:</p> <ul style="list-style-type: none"> Use oven cleaners in a well-ventilated room. Do not let commercial oven cleaners contact the heat seal, thermostat, or exterior surfaces of the range. This will cause damage. For easier cleaning you can remove the oven door. Carefully follow the instructions on page 39.
Oven cavity (Models FES330E and FES364E)	<ul style="list-style-type: none"> Wipe up food spills containing sugar as soon as possible after the oven cools down. (See "Using the Self-Cleaning Cycle" on page 29.) See "Using the Self-Cleaning Cycle" on pages 29-31.

SURFACE UNITS AND REFLECTOR BOWLS (MODELS FEP310E, FEP320E, FEP330E, FES330E)

Removing

1. Make sure all surface units are off and cool before removing surface units and reflector bowls.

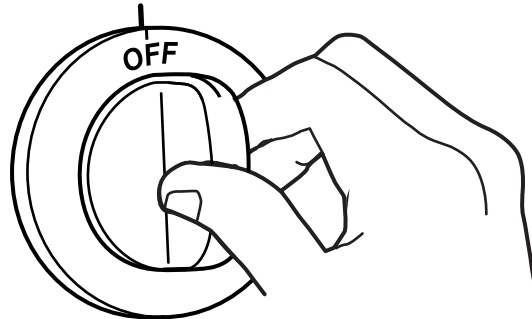

2. Push in the edge of the unit, opposite the receptacle. Then lift it just enough to clear the reflector bowl.

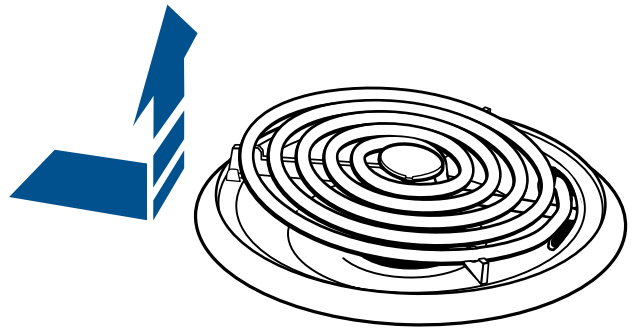

3. Pull the surface unit straight away from the receptacle.

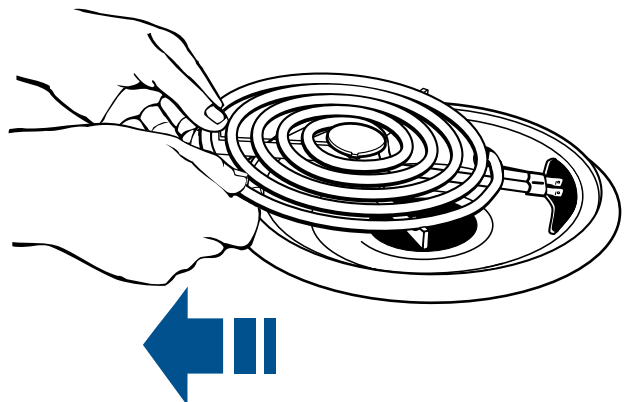

4. Lift out the reflector bowl. See "Cleaning chart" on page 32 for cleaning instructions.



SURFACE UNITS AND REFLECTOR BOWLS (CONT.)

Replacing

1. Make sure all surface units are off and cool before replacing surface units and reflector bowls.

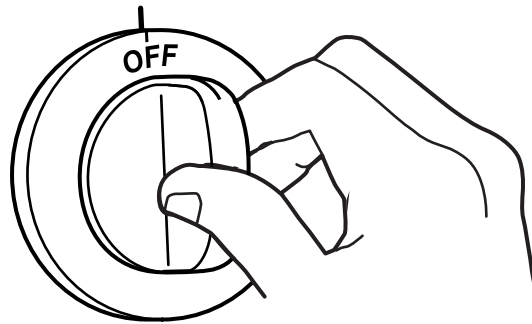

2. Line up openings in the reflector bowl with the surface unit receptacle.



3. Hold the surface unit as level as possible with the terminal just started into the receptacle. Push the surface unit terminal into the receptacle.

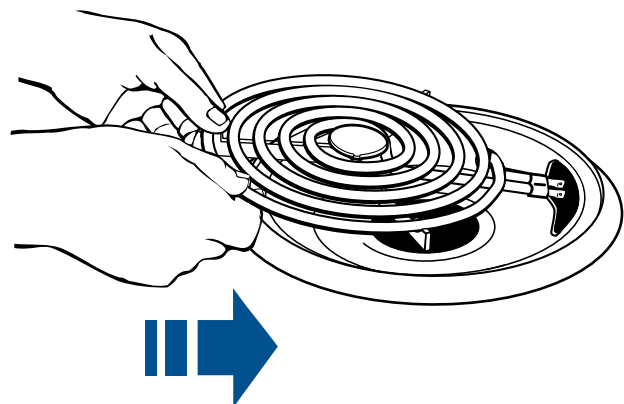

4. When the terminal is pushed into the receptacle as far as it will go, push down the edge of the surface unit opposite the receptacle.

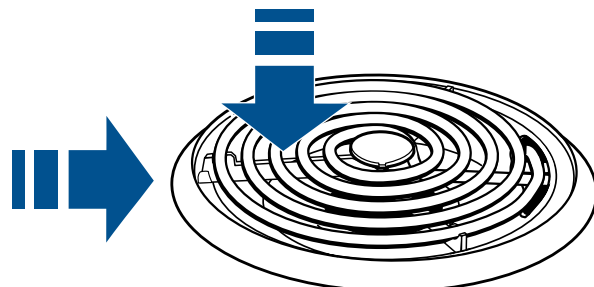

continued on next page

SURFACE UNITS AND REFLECTOR BOWLS (CONT.)

NOTE: Reflector bowls reflect heat back to the cookware on the surface units. They also help catch spills. When they are kept clean, they reflect heat better and look new longer.

If a reflector bowl changes color, some of your cookware may not be flat enough, or some may be

too large for the surface unit. In either case, some of the heat that's meant to go into or around cookware goes down and heats the reflector bowl. This extra heat can cause it to change color.

LIFT-UP COOKTOP (MODELS FEP310E, FEP320E, FEP330E, FES330E)

NOTE: Do not drop the cooktop. Damage could result to the porcelain and the cooktop frame.

1. Lift the front of the cooktop at both front corners until the support rods lock into place.
2. Wipe the surface under the cooktop with warm, soapy water and a sponge. Use a soapy steel-wool pad on heavily soiled areas.
3. To lower the cooktop, lift the cooktop from both sides while pressing the support rods back to unlock them. Lower the cooktop into place.

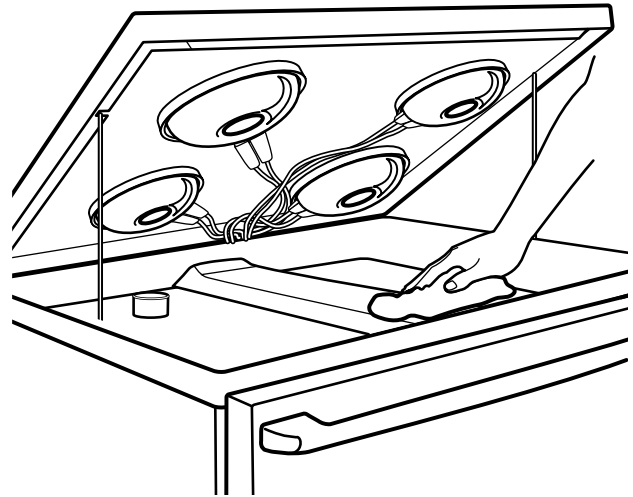

CLEANING THE CERAMIC GLASS COOKTOP (MODEL FES364E)

Your cooktop is designed for easy care. However, you need to maintain your ceramic glass cooktop differently than you would standard electric open-coil elements. Foods spilled directly on the cooktop will not burn off as on open-coil elements. Because of this, you should keep the surface dust free and soil free before heating.

Your cooktop has been prepolished at the factory for improved protection and easier cleaning. The Cooktop Polishing Creme included with your range, a soft cloth or a sponge, and a single-edge razor blade in a holder (see next page for ordering information) are all you need



to clean your cooktop. For proper cleaning methods, please review "Cleaning tips" in the next column and on the next page. Follow them after each time you use your cooktop. This will ensure you get the best performance out of your cooktop, as well as preserve that uniquely elegant look.

To avoid damaging the cooktop, follow these instructions:

- Remove sugar spills and soils from the cooktop while the surface is still warm to avoid pitting on the surface.
- Marks from sliding metal pans on the cooktop are difficult to remove completely. Use cooktop polishing creme to clean the area. Several applications may be necessary.
- Do not use steel wool, plastic cleaning pads, gritty powdered cleansers, chlorine bleach, rust remover, ammonia, or glass cleaning products with ammonia. These products could damage the cooktop surface.

Cleaning tips

What to use:

- **Cooktop Polishing Creme included with your range with a soft cloth or clean, damp sponge –**

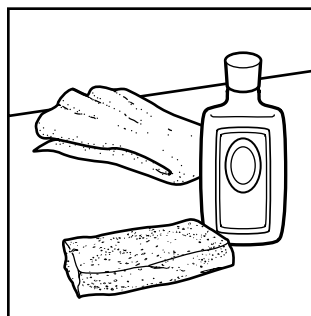

This creme has been developed especially for cleaning and protecting your cooktop. When using the creme, follow the instructions on the container.

- **Razor scraper in a holder –** Use this scraper to remove cooked-on soils from your ceramic glass cooktop. To avoid scratches, keep the razor blade as flat against the cooktop as possible. **Store razor blades out of reach of children.**



CLEANING THE CERAMIC GLASS COOKTOP (CONT.)

Steps to follow:

1. You can wipe off most spills easily using a soft cloth or clean, damp sponge as soon as the Hot Surface Indicator Light goes off.
2. For stubborn spills, rub the Cooktop Polishing Creme into cooked-on soil using a soft cloth. If some soil remains, leave some creme on the spot(s) and follow Step 3.
3. Carefully scrape spots with the razor scraper.
4. Finish by polishing the entire cooktop with Cooktop Polishing Creme and a soft cloth.

To order the Cooktop Polishing Creme (Part No. 3184477) or a razor scraper (Part No. 3183488), call 1-800-447-6737. You will hear a recording. Follow the steps to place an order.

How to keep your cooktop looking like new:

IF THERE ARE	WHAT TO DO
Sugary spills and soils (such as jellies and candy syrups)	To prevent pitting on the cooktop, wipe up with a soft cloth or clean, damp sponge while the ceramic glass surface is still warm . Remove spills as soon as possible after they occur.
Dark streaks, specks, and discoloration	Use the Cooktop Polishing Creme or a nonabrasive cleanser with a damp soft cloth or sponge.
Metal marks (from copper aluminum pans)	Use the Cooktop Polishing Creme or a gritty cleanser with a damp soft cloth or sponge before heating the cooktop again. If heated before cleaning, metal marks may not come off.
Tiny scratches or abrasions	Scratches and abrasions do not affect cooking. After many cleanings, they will become less visible. To prevent scratches and abrasions, use the Cooktop Polishing Creme regularly.

NOTE: Always wipe your cooktop with clean water and dry it well after using the cleanser to prevent streaking or staining.

REMOVING THE OVEN DOOR

For normal use of your range, you do not need to remove the door. However, if you have to remove the door follow the instructions in this section.

To remove:

1. Open the door about halfway. Insert nails or screws into both hinge hangers. **Do not remove them while the door is removed from the range.**
2. Close the door as far as the nails or screws will let you.

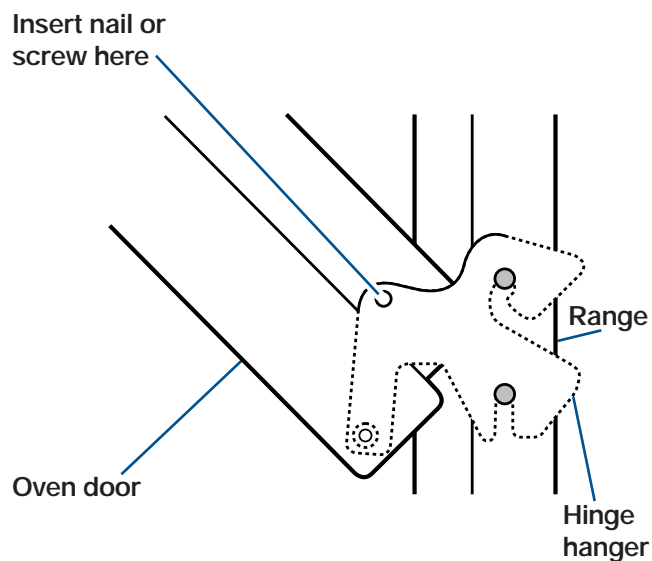

3. Rotate the door toward the range. Lift up the door until it stops. Do not use the door handle to lift the door. Rotate the door toward the floor and pull it toward you.

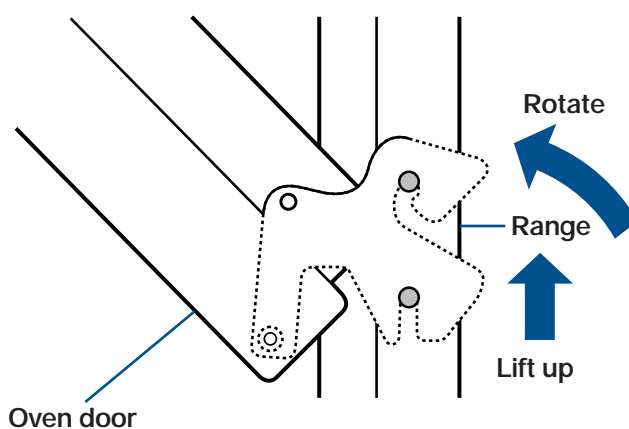
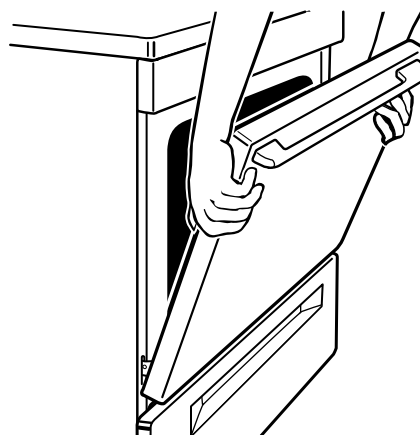

REMOVING THE OVEN DOOR (CONT.)

To replace:

NOTE: The nails or screws you inserted must still be in both sides of the door.

1. Grasp the door on the sides with your fingers on the front of the door and your thumbs on the inside surface.

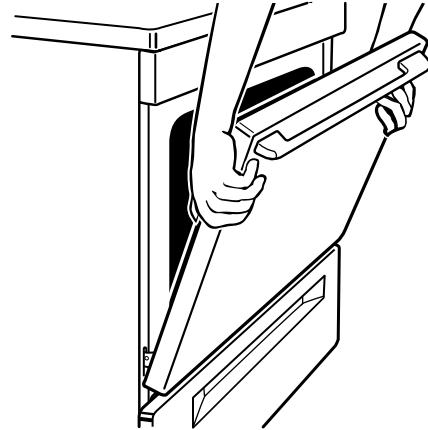

2. Rest the hinge hanger so that it is flat (at the bottom of the hinge hanger on the bottom of the front frame slot).
3. Position the door with the hinge hanger slots almost parallel to the front frame.
4. Push up and in until the hinge hanger slots become fastened to the range. Lower the door and rotate it slightly from the front to the back until the slots are fully fastened. The hinge hanger will be close to the bottom of the front frame slot.
5. Pull door open about halfway and remove the nails or screws.
6. Close the door.

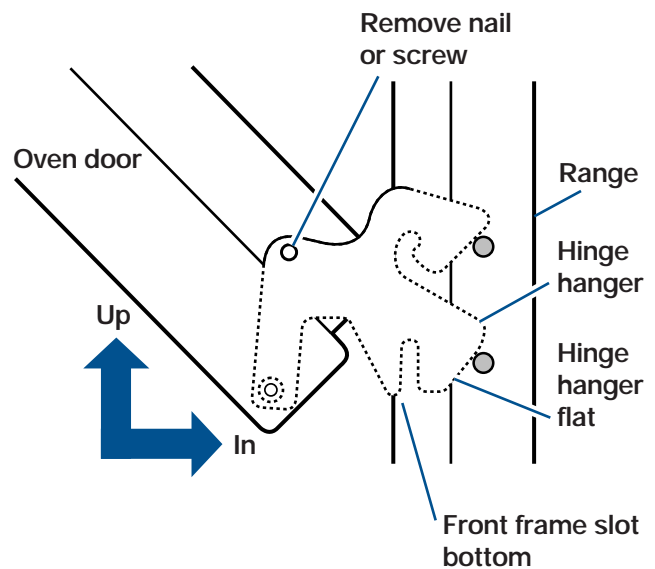

THE OVEN LIGHT (MODEL FES364E)

The oven light will come on when you open the oven door.

To replace the oven light:

1. Unplug the range or disconnect it at the main power supply.
2. Remove the glass bulb cover in the back of the oven by screwing it out counterclockwise.

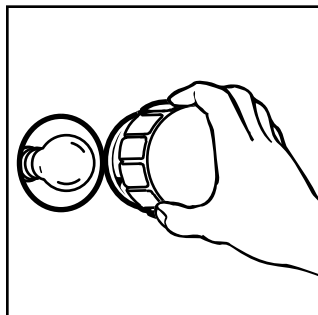

3. Remove the light bulb from its socket. Replace the bulb with a 40-watt appliance bulb.
4. Replace the bulb cover by screwing it in clockwise. Plug in the range or reconnect it at the main power supply.

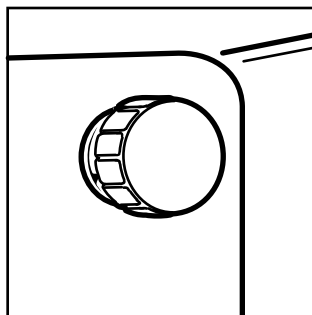

TROUBLESHOOTING

Most cooking problems often are caused by little things you can find and fix without tools of any kind. Check the lists below and on the next page before calling for assistance or service. If you still need help, see "Requesting Assistance or Service" on page 44.

RANGE DOES NOT WORK

PROBLEM	CAUSE
Nothing works	<ul style="list-style-type: none">• The range is not plugged into a live outlet with the proper voltage. (See Installation Instructions.)• You have blown a household fuse or tripped a circuit breaker.• The control knob is not set correctly. Push in the control knobs before turning them.
The oven does not work	<ul style="list-style-type: none">• You have not turned the oven temperature control knob to a temperature setting.• You have not set the oven selector to BAKE or BROIL (Models FEP310E, FEP320E, FEP330E).
The surface units will not work	<ul style="list-style-type: none">• You have blown a household fuse or tripped a circuit breaker.• The surface units are not plugged in all the way (Models FEP310E, FEP320E, FEP330E, FES330E). (See "Replacing" on page 35.)• You have not set the control knobs correctly. Push the control knobs in before turning them to a setting.

WHEN SELF-CLEANING YOUR OVEN (MODELS FES330E AND FES364E)

PROBLEM	CAUSE
The Self-Cleaning cycle will not work	<ul style="list-style-type: none">• You did not turn the oven control knob to CLEAN.• The door is not closed all the way.

COOKING RESULTS

PROBLEM	CAUSE
Cooking results are not what you expected	<ul style="list-style-type: none"> • The oven temperature seems too low or too high. See "Adjusting the oven temperature control" on page 20 to adjust the oven temperature. • You did not preheat the oven before baking (if called for in the recipe). • The recipe you are using may need to be altered to improve the taste or appearance of the food. • You are using a pan that is not the correct type or size. Refer to a reliable cookbook or recipe for the recommended pan type and size. • There is not enough air space around the pan when baking. Allow 1½ to 2 inches of air space on all sides of the pan. • The cookware is too large or too small for the surface unit being used. The pan should be the same size or slightly larger than the surface unit being used. • The range is not level. (See the Installation Instructions.)

INDICATOR LIGHTS FLASH (MODELS FES330E AND FES364E)

PROBLEM	CAUSE
The oven on and heating indicator lights flash	<ul style="list-style-type: none"> • You can not bake, broil, or clean. Call for service. (See "If You Need Assistance or Service" on page 44.)
The heating and door locked/cleaning indicator lights flash	<ul style="list-style-type: none"> • The door lock has failed. Call for service. (See "If You Need Assistance or Service" on page 44.)

If none of these items are causing your problem, see "Requesting Assistance or Service" on page 44.

REQUESTING ASSISTANCE OR SERVICE

To avoid unnecessary service calls, please check "Troubleshooting" on pages 42-43. It may save you the cost of a service call. If you still need help, follow the instructions below.

IF YOU NEED ASSISTANCE OR SERVICE

Call our Consumer Assistance Center toll free at 1-800-44-ROPER (1-800-447-6737).



Our consultants are available to assist you.

When calling:

Please know the purchase date, and the complete model and serial number of your appliance (see page 2). This information will help us better respond to your request.

Our consultants provide assistance with:

- Features and specifications on our full line of appliances
- Installation information
- Use and maintenance procedures

- Accessory and repair parts sales
- Do-it-yourself repair help
- Specialized customer assistance (Spanish speaking, hearing impaired, limited vision, etc.)
- Referrals to local dealers, service companies, and repair parts distributors

To locate an authorized servicer in your area, you can also look in your telephone directory Yellow Pages.

IF YOU NEED REPLACEMENT PARTS

If you need to order replacement parts, we recommend that you only use FSP® factory authorized parts. FSP replacement parts will fit right and work right, because they are made to the same exacting specifications used to build every new ROPER® appliance.

To locate FSP replacement parts in your area, call our Consumer Assistance Center telephone number or your nearest authorized service center.

FOR FURTHER ASSISTANCE

If you need further assistance, you can write to us with any questions or concerns at:

Roper Brand Home Appliances
Consumer Assistance Center
c/o Correspondence Dept.
2000 North M-63
Benton Harbor, MI 49022-2692

Please include a daytime phone number in your correspondence.

If the dealer, authorized servicer, and Roper Brand Appliance warrantor have failed to resolve your problem, you can contact the Major Appliance Consumer Action Program (MACAP). MACAP is a group of independent consumer experts that voice consumer views at the highest levels of the major appliance industry. MACAP will in turn inform us of your action.

Major Appliance Consumer Action Program
20 North Wacker Drive
Chicago, IL 60606

INDEX

This index is alphabetical. It contains all the topics included in this manual, along with the page(s) on which you can find each topic.

TOPIC	PAGE	TOPIC	PAGE
AIR CIRCULATION	14	OVEN DOOR	39, 40
ANTI-TIP BRACKET	27	OVEN LIGHT	41
ASSISTANCE	44	OVEN TEMPERATURE	
BAKING		Adjusting	20
Aluminum foil	14	Setting	17, 18
Pans	13, 14	OVEN VENT	26
Racks	13	PANS	13, 14
Setting cycle	17, 18	PARTS	6-9
Tips	17, 19	RACKS	13
BROILING		ROASTING	
Grid	25	Pans	13, 14
Guide	25	Racks	13
Pan	21, 23, 25	Setting cycle	17, 18
Rack positions	25	Tips	17, 19
Setting cycle	22, 24	SAFETY	3-5
Tips	25	SELF-CLEANING CYCLE	
CLEANING		Before you start	29
Broiler pan and grid	33	How the cycle works	31
Ceramic glass cooktop	37, 38	Setting the controls	30
Control knobs	32	Tips	31
Control panel	32	SERVICE	44
Exterior surfaces	32	STORAGE DRAWER	28
Oven cavity	33	SURFACE UNITS	
Oven door glass	33	Ceramic glass cooktop	12
Oven racks	33	Control knobs	10, 32
Reflector bowls	32, 34	Control setting guide	10
Self-cleaning cycle	29	Hot surface indicator light	12
Surface units	32, 34	Oven on indicator light	8, 9
CLOCK	15	Surface heating indicator light	8, 9
CONTROL PANEL		Surface unit markers	6-9
Control knobs	10	Tips	10
Hot surface indicator light	12	TIPS	
Oven on indicator light	8, 9	Bakeware	13
Surface heating indicator light	8, 9	Broiling	25
Surface unit markers	6-9	Cookware	11, 12
COOKWARE		Energy saving	10, 17, 19
Canning	11	Roasting	17, 19
Tips	11, 12	Self-cleaning	31
FEATURES	6-9	TROUBLESHOOTING	42, 43
LIFT-UP COOKTOP	36	WARRANTY	48
MINUTE TIMER	16		
MODEL AND SERIAL NUMBER	2		

WARRANTY

ROPER® ELECTRIC RANGE

LENGTH OF WARRANTY	WE WILL PAY FOR
FULL ONE-YEAR WARRANTY FROM DATE OF PURCHASE	FSP® replacement parts and repair labor to correct defects in materials or workmanship. Service must be provided by an authorized Roper service company.
WE WILL NOT PAY FOR	
<ul style="list-style-type: none"> A. Service calls to: <ol style="list-style-type: none"> 1. Correct the installation of your range. 2. Instruct you how to use your range. 3. Replace house fuses or correct house wiring. 4. Replace owner-accessible light bulbs. B. Repairs when your range is used in other than normal, single-family household use. C. Pickup and delivery. Your range is designed to be repaired in the home. D. Damage to your range caused by accident, misuse, fire, flood, acts of God, or use of products not approved by us. E. On ceramic glass cooktop model, repairs to ceramic glass cooktop if it has not been cared for as recommended in this Use and Care Guide. F. Repairs to parts or systems caused by unauthorized modifications made to the appliance. 	

3/96

THIS ROPER APPLIANCE IS WARRANTED BY WHIRLPOOL CORPORATION. UNDER NO CIRCUMSTANCES SHALL IT BE LIABLE UNDER THIS WARRANTY FOR INCIDENTAL OR CONSEQUENTIAL DAMAGES. Some states do not allow the exclusion or limitation of incidental or consequential damages, so this exclusion or limitation may not apply to you. This warranty gives you specific legal rights, and you may also have other rights which vary from state to state.

Outside the United States, a different warranty may apply. For details, please contact your authorized Roper dealer.

If you need service, first see the "Troubleshooting" section of this book. After checking "Troubleshooting," additional help can be found by checking the "Requesting Assistance or Service" section or by calling our toll-free telephone number, **1-800-44-ROPER (1-800-447-6737)**, from anywhere in the U.S.A.

Free Manuals Download Website

<http://myh66.com>

<http://usermanuals.us>

<http://www.somanuals.com>

<http://www.4manuals.cc>

<http://www.manual-lib.com>

<http://www.404manual.com>

<http://www.luxmanual.com>

<http://aubethermostatmanual.com>

Golf course search by state

<http://golfingnear.com>

Email search by domain

<http://emailbydomain.com>

Auto manuals search

<http://auto.somanuals.com>

TV manuals search

<http://tv.somanuals.com>