

Use & Care

G U I D E

Self-Cleaning And Standard-Cleaning Electric Ranges

A Note to You	2
Range Safety	3
Parts and Features ...	6
Using Your Range	9
Using the Self- Cleaning Cycle.....	27
Caring for Your Range	30
Troubleshooting	36
Requesting Assistance or Service	38
Index	39
Warranty	40

TO THE INSTALLER: PLEASE
LEAVE THIS INSTRUCTION
BOOK WITH THE UNIT.
TO THE CONSUMER: PLEASE
READ AND KEEP THIS BOOK
FOR FUTURE REFERENCE.

MODELS FEP310G FEP320G
FEP330G FES330G

PART NO. 8053404

ROPER[®]
Home Appliances

A NOTE TO YOU

Thank you for buying a ROPER® appliance.

Your ROPER range gives you all the functionality of name brand appliances at a value price. To ensure that you enjoy years of trouble-free operation, we developed this Use and Care Guide. It is full of valuable information about how to operate and maintain your appliance properly and safely. Please read it carefully.

Also, please complete and mail the **Product Registration Card** provided with your appliance. The card helps us notify you about any new information on your appliance.

Please record your model's information.

Whenever you call to request service for your appliance, you need to know your complete model number and serial number. You can find this information on the model and serial number label/plate (see the diagram in the "Parts and Features" section).

Please also record the purchase date of your appliance and your dealer's name, address, and telephone number.

Model Number _____

Serial Number _____

Purchase Date _____

Dealer Name _____

Dealer Address _____

Dealer Phone _____

Keep this book and the sales slip together in a safe place for future reference. It is important for you to save your sales receipt showing the date of purchase. Proof of purchase will assure you of in-warranty service.

RANGE SAFETY

Your safety and the safety of others is very important.

We have provided many important safety messages in this manual and on your appliance. Always read and obey all safety messages.



This is the safety alert symbol.

This symbol alerts you to hazards that can kill or hurt you and others.

All safety messages will be preceded by the safety alert symbol and the word "DANGER" or "WARNING." These words mean:

⚠️ DANGER

You **will** be killed or seriously injured if you don't follow instructions.

⚠️ WARNING

You **can** be killed or seriously injured if you don't follow instructions.

All safety messages will identify the hazard, tell you how to reduce the chance of injury, and tell you what can happen if the instructions are not followed.



⚠️ WARNING

Tip Over Hazard

A child or adult can tip the range and be killed.

Connect anti-tip bracket to rear range foot.

Reconnect the anti-tip bracket, if the range is moved.

See the installation instructions for details.

Failure to follow these instructions can result in death or serious burns to children and adults.

Anti-Tip Bracket

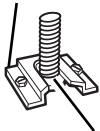

Range Foot

Making sure the anti-tip bracket is installed:

- Slide range forward.
- Look for the anti-tip bracket securely attached to floor.
- Slide range back so rear range foot is under anti-tip bracket.

continued on next page

IMPORTANT SAFETY INSTRUCTIONS

WARNING: To reduce the risk of fire, electrical shock, injury to persons, or damage when using the range, follow basic precautions, including the following:

- **WARNING – TO REDUCE THE RISK OF TIPPING OF THE RANGE, THE RANGE MUST BE SECURED BY PROPERLY INSTALLED ANTI-TIP DEVICES. TO CHECK IF THE DEVICES ARE INSTALLED PROPERLY, SLIDE RANGE FORWARD, LOOK FOR ANTI-TIP BRACKET SECURELY ATTACHED TO FLOOR, AND SLIDE RANGE BACK SO REAR RANGE FOOT IS UNDER ANTI-TIP BRACKET.**
- **CAUTION –** Do not store items of interest to children in cabinets above a range or on the backguard of a range – children climbing on the range to reach items could be seriously injured.
- **Proper Installation –** Be sure the range is properly installed and grounded by a qualified technician.
- **Never Use the Range for Warming or Heating the Room.**
- **Do Not Leave Children Alone –** Children should not be left alone or unattended in area where the range is in use. They should never be allowed to sit or stand on any part of the range.
- **Wear Proper Apparel –** Loose-fitting or hanging garments should never be worn while using the range.
- **User Servicing –** Do not repair or replace any part of the range unless specifically recommended in the manual. All other servicing should be referred to a qualified technician.
- **Storage in or on the Range –** Flammable materials should not be stored in an oven or near surface units.
- **Do Not Use Water on Grease Fires –** Smother fire or flame or use dry chemical or foam-type extinguisher.
- **Use Only Dry Potholders –** Moist or damp potholders on hot surfaces may result in burns from steam. Do not let potholder touch hot heating elements. Do not use a towel or other bulky cloth.
- **DO NOT TOUCH SURFACE UNITS OR AREAS NEAR UNITS –** Surface units may be hot even though they are dark in color. Areas near surface units may become hot enough to cause burns. During and after use, do not touch, or let clothing or other flammable materials contact surface units or areas near units until they have had sufficient time to cool. Among those areas are the cook-top and surfaces facing the cook-top.
- **Use Proper Pan Size –** The range is equipped with one or more surface units of different size. Select utensils having flat bottoms large enough to cover the surface unit heating element. The use of undersized utensils will expose a portion of the heating element to direct contact and may result in ignition of clothing. Proper relationship of utensil to burner will also improve efficiency.
- **Never Leave Surface Units Unattended at High Heat Settings –** Boilover causes smoking and greasy spillovers that may ignite.
- **Make Sure Reflector Pans or Drip Bowls Are in Place –** Absence of these pans or bowls during cooking may subject wiring or components underneath to damage.
- **Protective Liners –** Do not use aluminum foil to line surface unit drip bowls or oven bottoms, except as suggested in the manual. Improper installation of these liners may result in a risk of electric shock, or fire.
- **Glazed Cooking Utensils –** Only certain types of glass, glass/ceramic, ceramic, earthenware, or other glazed utensils are suitable for range-top service without breaking due to the sudden change in temperature.
- **Utensil Handles Should Be Turned Inward and Not Extend Over Adjacent Surface Units –** To reduce the risk of burns, ignition of flammable materials, and spillage due to unintentional contact with the utensil, the handle of a utensil should be positioned so that it is turned inward, and does not extend over adjacent surface units.
- **Do Not Soak Removable Heating Elements –** Heating elements should never be immersed in water.

– **SAVE THESE INSTRUCTIONS** –

IMPORTANT SAFETY INSTRUCTIONS

- Do Not Cook on Broken Cook-Top – If cook-top should break, cleaning solutions and spillovers may penetrate the broken cook-top and create a risk of electric shock. Contact a qualified technician immediately.
- Clean Cook-Top With Caution – If a wet sponge or cloth is used to wipe spills on a hot cooking area, be careful to avoid steam burn. Some cleaners can produce noxious fumes if applied to a hot surface.
- Use Care When Opening Door – Let hot air or steam escape before removing or replacing food.
- Do Not Heat Unopened Food Containers – Build-up of pressure may cause container to burst and result in injury.
- Keep Oven Vent Ducts Unobstructed.
- Placement of Oven Racks – Always place oven racks in desired location while oven is cool. If rack must be moved while oven is hot, do not let potholder contact hot heating element in oven.
- DO NOT TOUCH HEATING ELEMENTS OR INTERIOR SURFACES OF OVEN – Heating elements may be hot even though they are dark in color. Interior surfaces of an oven become hot enough to cause burns. During and after use, do not touch, or let clothing or other flammable materials contact heating elements or interior surfaces of oven until they have had sufficient time to cool. Other surfaces of the appliance may become hot enough to cause burns – among these surfaces are oven vent openings and surfaces near these openings, oven doors, and windows of oven doors.

For self-cleaning ranges –

- Do Not Clean Door Gasket – The door gasket is essential for a good seal. Care should be taken not to rub, damage, or move the gasket.
- Do Not Use Oven Cleaners – No commercial oven cleaner or oven liner protective coating of any kind should be used in or around any part of the oven.
- Clean Only Parts Listed in Manual.
- Before Self-Cleaning the Oven – Remove broiler pan and other utensils.

For units with ventilating hood –

- Clean Ventilating Hoods Frequently – Grease should not be allowed to accumulate on hood or filter.
- When flaming foods under the hood, turn the fan off. The fan, if operating, may spread the flame.

– SAVE THESE INSTRUCTIONS –

PARTS AND FEATURES

(Model FES330G shown)

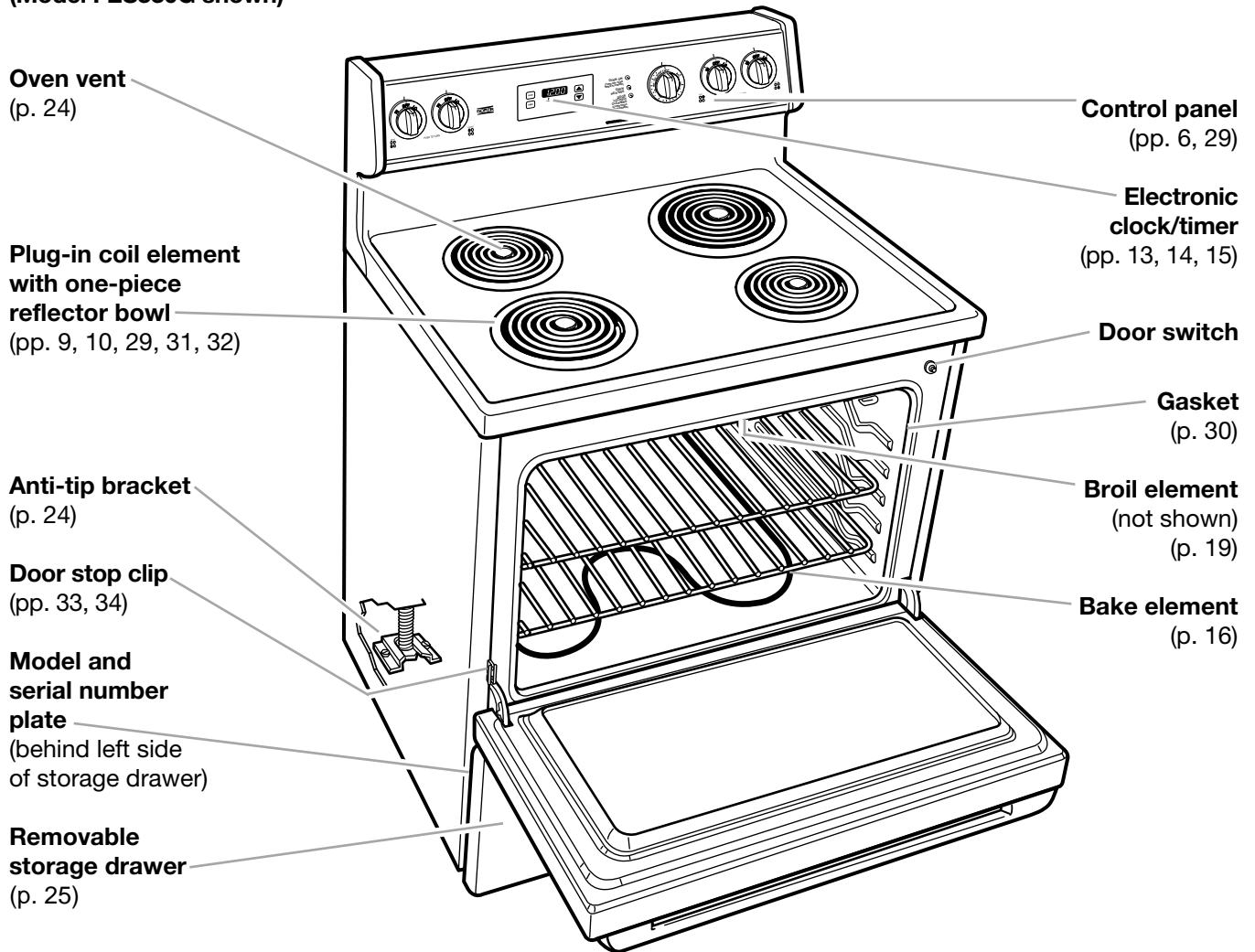

CONTROL PANEL

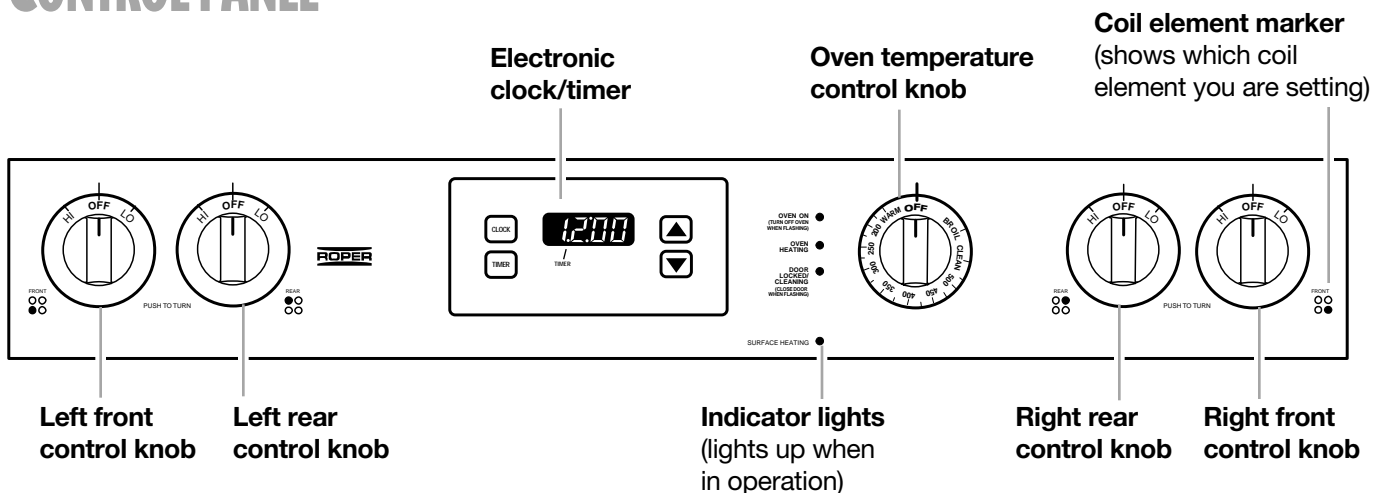

(Model FEP330G shown)

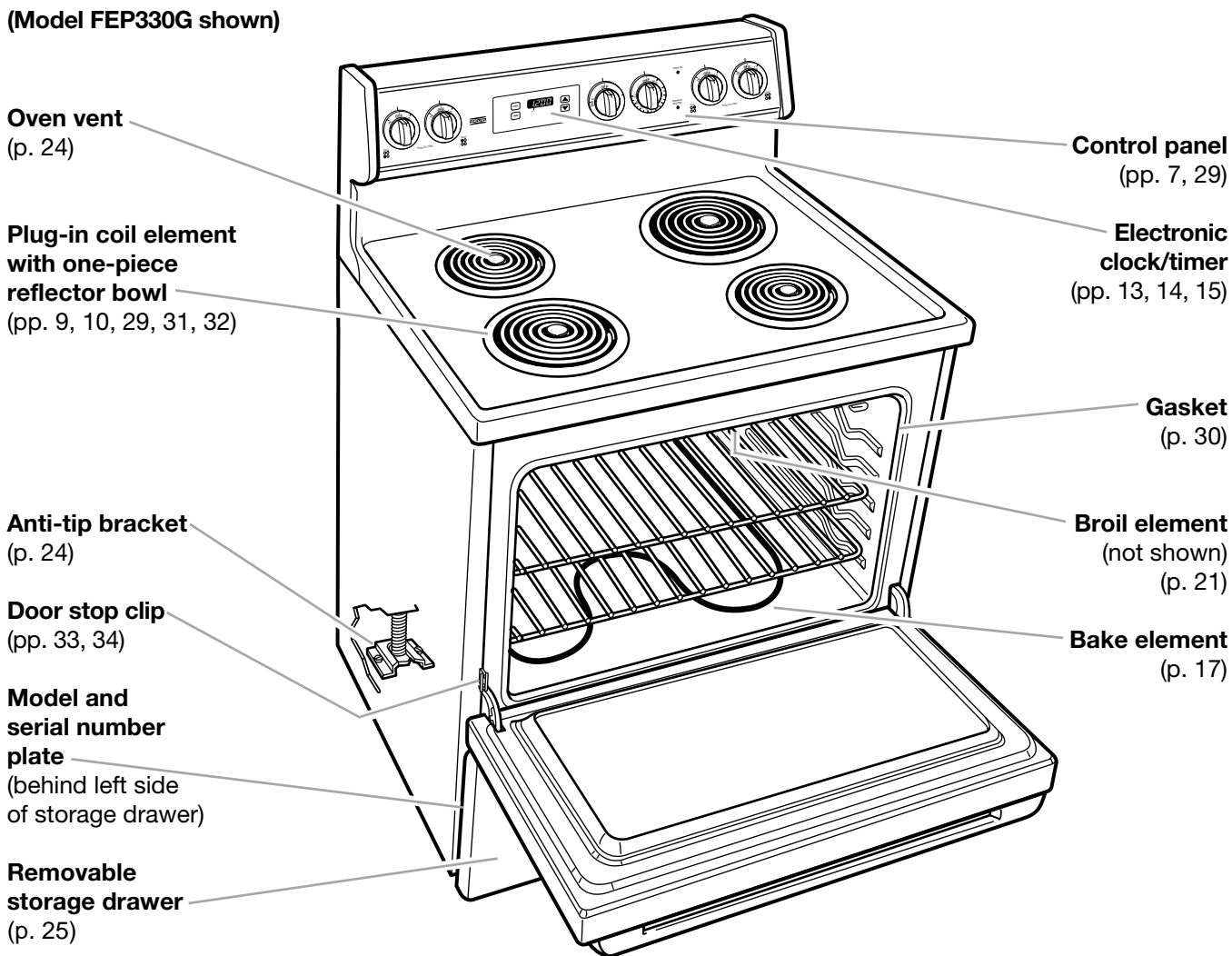

CONTROL PANEL

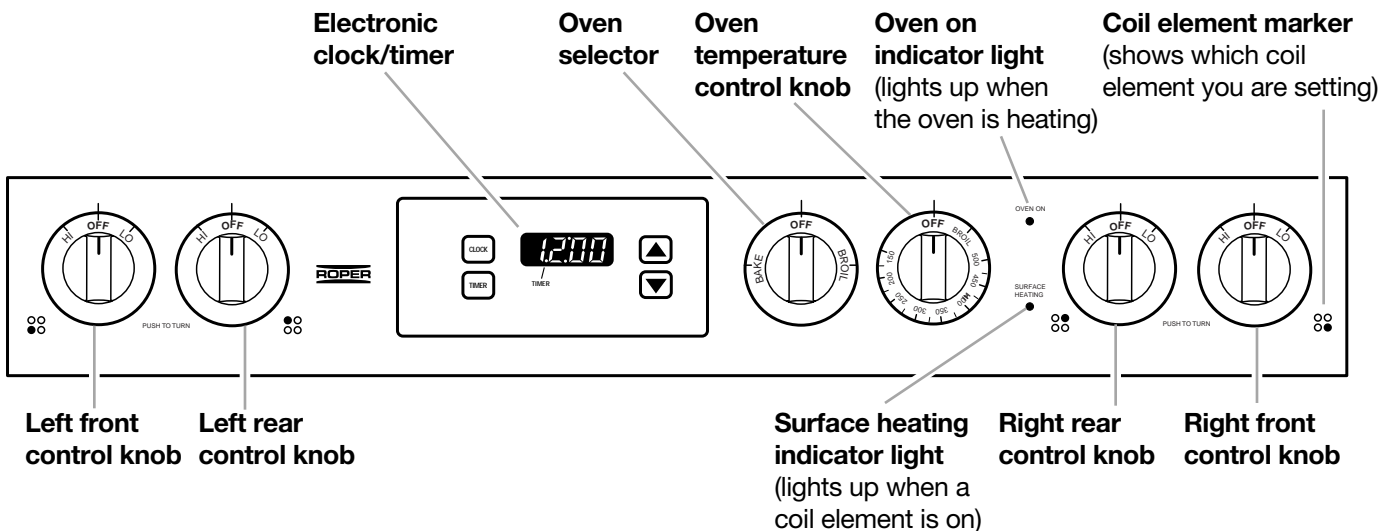

(Models FEP310G and FEP320G shown)

Oven vent
(p. 24)

Plug-in coil element with one-piece reflector bowl
(pp. 9, 10, 29, 31, 32)

Anti-tip bracket
(p. 24)

Door stop clip
(pp. 33, 34)

Model and serial number plate
(behind left side of storage drawer)

Removable storage drawer
(p. 25)

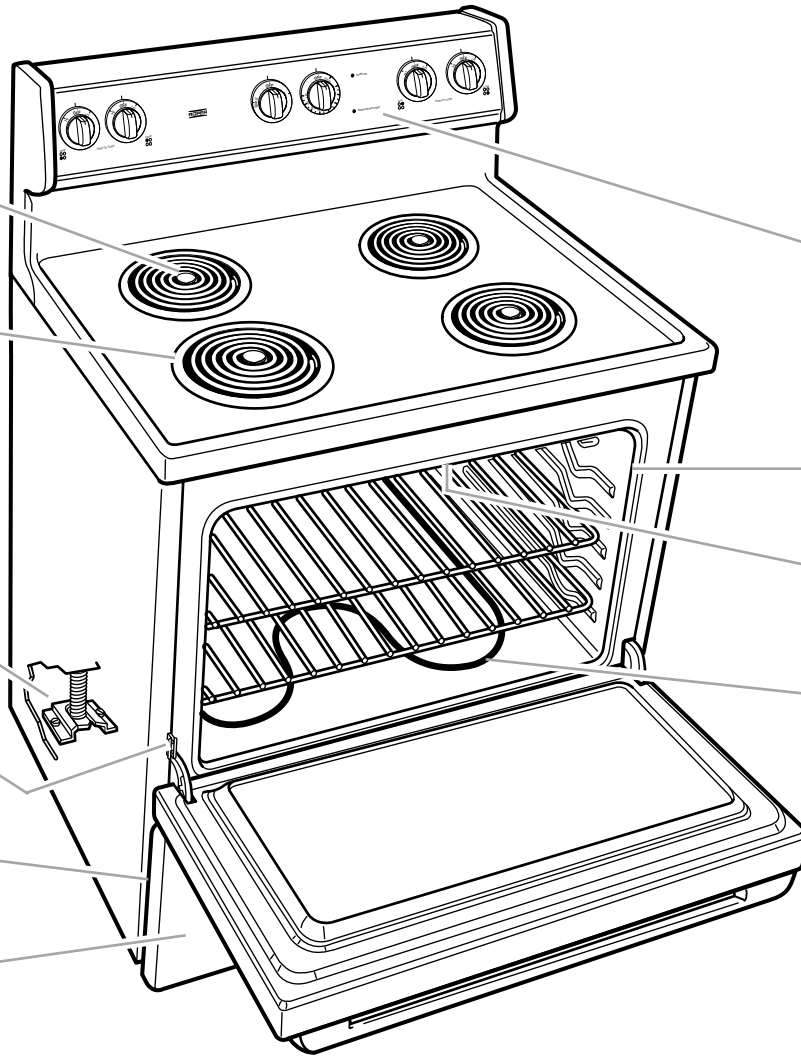

Control panel
(pp. 8, 29)

Gasket
(p. 30)

Broil element
(not shown)
(p. 21)

Bake element
(p. 17)

CONTROL PANEL

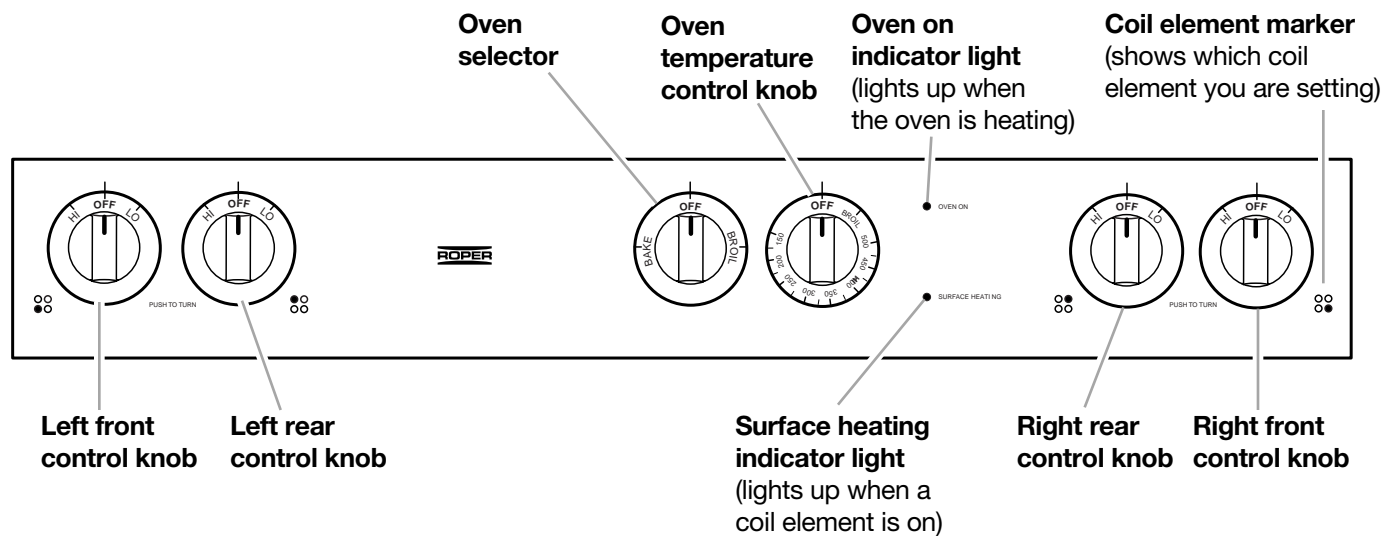

USING YOUR RANGE

USING THE COIL ELEMENTS

Using the control knobs

Push in the control knobs before turning them to a setting. You can set them anywhere between HI and OFF.

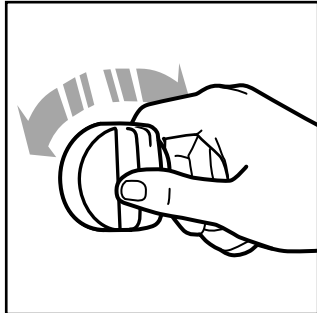

⚠ WARNING



Fire Hazard

Turn off all controls when done cooking.
Failure to do so can result in death or fire.

Coil element heat settings

Use the following chart as a guide.

SETTING	RECOMMENDED USE
HI	<ul style="list-style-type: none">● To start food cooking.● To bring liquid to a boil.
6-8	<ul style="list-style-type: none">● To hold a boil.● To quickly brown or sear food.
5	<ul style="list-style-type: none">● To maintain a slow boil.● To fry poultry or meat.● To make pudding, sauce, or gravy.
2-4	<ul style="list-style-type: none">● To stew or steam food.● To simmer food.
LO	<ul style="list-style-type: none">● To keep food warm.● To melt chocolate or butter.

USING THE COIL ELEMENTS (CONT.)

Home canning information

To protect your range:

- Use flat-bottomed canners on all types of cooktops. Canners with rippled or ridged bottoms do not allow good contact with the surface.

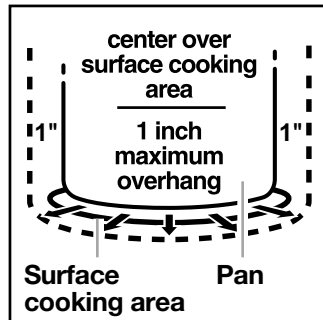

- Center the canner over the largest coil element. Do not extend more than one inch outside the coil element. Large diameter canners/pans, if not

centered correctly, trap heat and can cause damage to the cooktop.

- Do not place your canner on two coil elements at the same time.
- The type of material the canner is made of determines the length of heating time. Refer to the "Characteristics of cookware materials" chart later in this section for more information.
- When canning for long periods of time, allow elements and the surrounding surfaces to cool down.

- Alternate use of the coil elements between batches or prepare small batches at a time.
- Start with hot water, cover with a lid, and bring to a boil; then reduce heat to maintain a boil or required pressure levels in a pressure canner.
- On coil element model, keep your reflector bowls clean so that they will always reflect heat well.
- For up-to-date information on canning, contact your local U.S. Government Agricultural Department Extension Office or companies who manufacture home canning products.

Optional canning kit

Most water-bath or pressure canners have large diameters. If you do canning with them at high heat settings for long periods of time, you can shorten the life of regular coil elements. This can also damage the cooktop. If you plan to use the cooktop for canning, we recommend the installation of a Canning Kit. Order the kit (Part No. 242905) from your dealer or authorized service company.

Cookware tips

- **Select a pan** that is about the same size as the surface cooking area. Cookware should not extend more than 1 inch (2.5 cm) outside the area.
- **For best results and greater energy efficiency**, use only flat-bottomed cookware that makes good contact with the surface cooking area. Cookware with rounded, warped, ribbed (such as some porcelain enamelware), or dented bottoms could cause uneven heating and poor cooking results.
- **Cookware designed** with slightly indented bottoms or small expansion channels can be used.
- **Cookware with a non-stick finish** has heating characteristics of the base material.
- **Use flat bottom cookware** for best heat conduction from the surface cooking area to the cookware. Determine flatness with the ruler test. Place the edge of a ruler across the bottom of the cookware. Hold it up to the light. No light should be visible under the ruler. Rotate the ruler in all directions and look for any light.
- **Do not leave** empty cookware, or cookware which has boiled dry, on a hot surface cooking area. The cookware could overheat, causing damage to the cookware or the surface cooking area.

CHARACTERISTICS OF COOKWARE MATERIALS

The pan material affects how fast heat transfers from the coil element through the pan material and how evenly heat spreads over the pan bottom. Choose pans that provide the best cooking results.

Aluminum	<ul style="list-style-type: none"> • Heats quickly and evenly. • Use for all types of cooking. • Medium or heavy thickness is best for most cooking. • Used as a core or base in cookware to provide even heating.
Cast iron	<ul style="list-style-type: none"> • Heats slowly and evenly. • Good for browning and frying. • Maintains heat for slow cooking. • Can be coated with porcelain enamel.
Ceramic or ceramic glass	<ul style="list-style-type: none"> • Heats slowly and unevenly. • Use on low to medium settings. • Follow manufacturer's instructions.
Copper	<ul style="list-style-type: none"> • Heats very quickly and evenly. • Used as a core or base in cookware to provide even heating.
Earthenware	<ul style="list-style-type: none"> • Can be used for cooktop cooking if recommended by the manufacturer. • Use on low settings.
Porcelain enamel-on-steel or enamel-on-cast iron	<ul style="list-style-type: none"> • See cast iron and stainless steel.
Stainless steel	<ul style="list-style-type: none"> • Heats quickly but unevenly. • A core or base of aluminum or copper on the cookware provides even heating. • Can be coated with porcelain enamel.

USING THE OVEN

Positioning racks and pans

Place the oven racks where you need them before turning on the oven.

- To move a rack, pull it out to the stop position, raise the front edge and lift it out.
- Be sure the rack(s) is level.
- Use pot holders or oven mitts to protect your hands if rack(s) must be moved while the oven is hot.
- For best performance, cook on one rack. Place the rack so the top of the food will be centered in the oven.
- When cooking with two racks, arrange the racks on the 2nd and 4th rack guides. Two sheets of cookies may be baked if sheets are switched at approximately three quarters of the total bake time. Increase baking time, if necessary.
- For best results allow 2 inches of space around each pan and between pans and oven walls.

Hot air must circulate around the pans in the oven for even heat to reach all parts of the oven. This results in better baking.

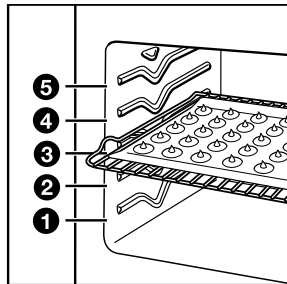

Where to place pans:

WHEN YOU HAVE	PLACE
1 pan	In center of the oven rack.
2 pans	Side by side or slightly staggered.
3 or 4 pans	In opposite corners on each oven rack. Stagger pans so no pan is directly over another.

Rack placement for specific foods:

FOOD	RACK POSITION
Frozen pies, large roasts, turkeys, angel food cakes	1st or 2nd rack guide from bottom
Bundt cakes, most quick breads, yeast breads, casseroles, meats	2nd rack guide from bottom
Cookies, biscuits, muffins, cakes, nonfrozen pies	2nd or 3rd rack guide from bottom

NOTE: For information on where to place your rack when broiling, see “Broiling guidelines” later in this section.

BAKEWARE CHOICES

Baking performance is affected by the type of bakeware used. Use the bakeware size recommended in the recipe.

BAKEWARE TYPE	BEST USED FOR	GUIDELINES
Light colored aluminum	<ul style="list-style-type: none"> • Light golden crusts • Even browning 	<ul style="list-style-type: none"> • Use temperature and time recommended in recipe.
Dark aluminum and other bakeware with dark, dull, and/or non-stick finish	<ul style="list-style-type: none"> • Brown, crisp crusts 	<ul style="list-style-type: none"> • May reduce baking temperature 25°F. • Use suggested baking time. • Use temperature and time recommended in recipe for pies, breads, and casseroles. • Place rack in center of oven.
Ovenproof glassware, ceramic glass, or ceramic	<ul style="list-style-type: none"> • Brown, crisp crusts 	<ul style="list-style-type: none"> • May reduce baking temperature 25°F.
Insulated cookie sheets or baking pans	<ul style="list-style-type: none"> • Little or no bottom browning 	<ul style="list-style-type: none"> • Place in the bottom third of oven. • May need to increase baking time.
Stainless steel	<ul style="list-style-type: none"> • Light, golden crusts • Uneven browning 	<ul style="list-style-type: none"> • May need to increase baking time.
Stoneware	<ul style="list-style-type: none"> • Crisp crusts 	<ul style="list-style-type: none"> • Follow manufacturer's instructions.

USING ALUMINUM FOIL

- Use aluminum foil to catch spillovers from pies or casseroles by placing foil on the oven rack below. Foil should be turned up at edges and be at least 1 inch larger than dish.

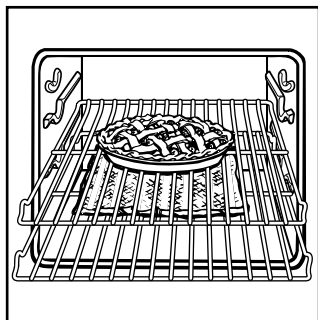

- Do not cover the entire rack with aluminum foil. It will reduce air circulation and give you poor cooking results.

- Do not line the oven bottom with foil or other liners. It could affect the oven surface as well as the quality of your baking.
- Place tent-shaped foil loosely over meat or poultry to slow down surface browning for long term roasting. Remove foil for the last 30 minutes.
- Use narrow strips of foil to shield piecrust edges if browning too quickly.

THE ELECTRONIC TIME-OF-DAY (TOD) CLOCK/TIMER (MODELS FEP330G AND FES330G)

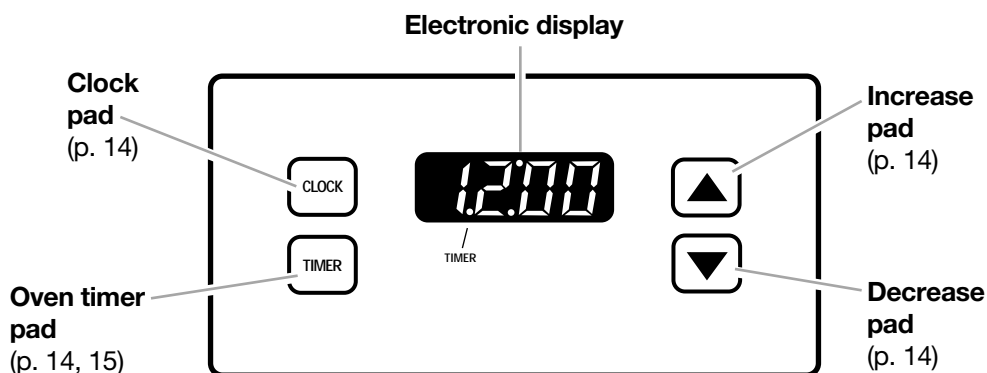

Display/clock

- **When you first plug in the range**, a flashing time-of-day (Model FEP330G) or "PF" (Model FES330G) appears in the display. If, after you set the clock (see "Setting the clock" section), the display flashes, your electricity was off for a while. Reset the clock.
- **When you are not using the oven**, the display shows the time of day.
- **When showing the time of day**, the display will show the hour and minutes.
- **When you are using the timer**, the display will show seconds for time less than 1 minute, minutes for time less than 1 hour, and hours and minutes for time over 1 hour. The timer indicator light will be lit when in the timer mode.

SETTING THE CLOCK (MODELS FEP330G AND FES330G)

1. Press CLOCK. The colon flashes during clock programming.

PRESS



YOU SEE



2. Set the time.

Press the “up” (▲) or “down” (▼) pad(s) until the correct time shows on the display.

NOTE: Press a pad briefly to change time by a small amount. Press and hold a pad to change time by 10 minute increments.

PRESS



YOU SEE

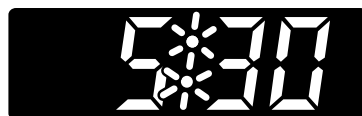

3. Press CLOCK again to start the clock. The colon stops flashing when the clock is active.

PRESS



YOU SEE



USING THE ELECTRONIC TIMER (MODELS FEP330G AND FES330G)

The timer does not start or stop the oven. It works like a kitchen timer. It can be set in hours and minutes up to 12 hours, 59 minutes. The timer will display minutes for settings under 1 hour and hours and minutes for settings over 1 hour. You will hear four 1-second tones when the set time is up.

NOTE: To display the time of day while the timer is counting down, press CLOCK. Time of day will be displayed for 5 seconds before returning to the timer countdown.

1. Press TIMER. The colon flashes during timer programming.

PRESS



YOU SEE



2. Set the interval to be timed.

Press the “up” (▲) or “down” (▼) pad(s) until the correct time shows on the display.

The timer will begin counting down 5 seconds after the time is set.

PRESS



YOU SEE

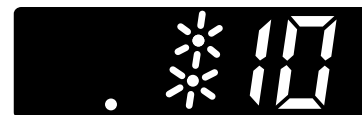

USING THE ELECTRONIC TIMER (MODELS FEP330G AND FES330G) (CONT.)

- When there is 1 minute of time remaining, you will hear one tone (Model FEP330G). The display will then begin counting down in seconds.

When the timer countdown reaches zero, the display will show "End" and you will hear four 1-second tones.

YOU SEE

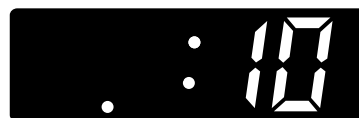

(display counts in seconds)

YOU SEE



To cancel the timer:

Press **TIMER** twice while in the timer mode.

PRESS



YOU SEE



(time of day)

BAKING/ROASTING (MODEL FES330G)

- Place the racks where you need them in the oven. For more information, see "Positioning racks and pans" under "Using the oven" earlier in this section.

NOTE: Do not place food directly on the oven door or the oven bottom.

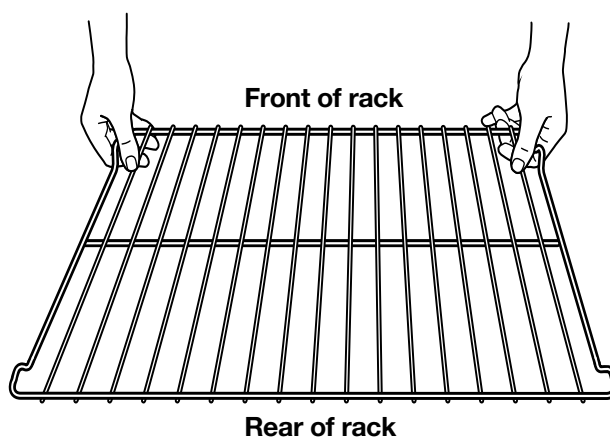

- Push and turn the oven control knob to the baking/roasting temperature you want.

NOTE: Do not preheat the oven when roasting.

PUSH AND TURN

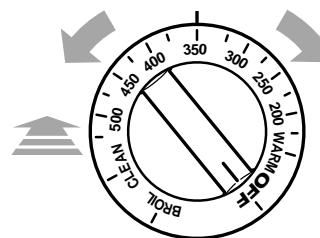

YOU SEE

OVEN ON and **HEATING** lights go on. Set Temperature appears in the display for 5 seconds.

continued on next page

BAKING/ROASTING (MODEL FES330G) (CONT.)

3. Put your food in the oven.

During baking/roasting, the elements will turn on and off to keep the oven temperature at the setting.

NOTE: The top element helps heat during baking/roasting, but does not turn red.

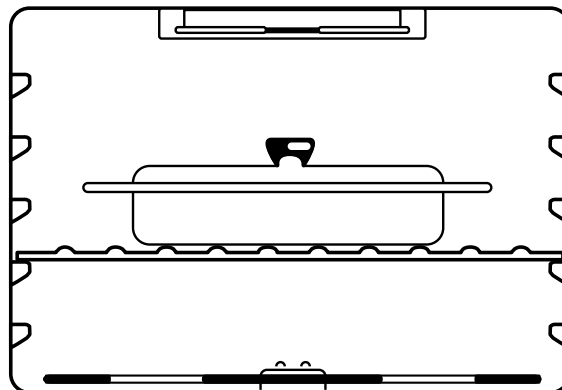

4. After baking/roasting, push and turn the oven control knob to OFF.

PUSH AND TURN

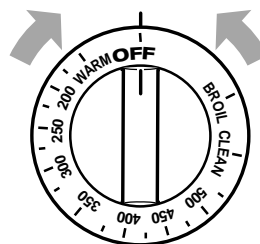

YOU SEE

OVEN ON and **HEATING** lights go out.

Saving energy

- To avoid loss of heat, open the oven door as little as possible.
- Use a timer to keep track of cooking time.
- Plan your meals for the most efficient use of the oven by cooking more than one food at a time, or baking while the oven is still hot after cooking a meal.

Roasting meats and poultry

- For even cooking, place the meat on a rack in a shallow pan. This keeps the meat out of the drippings and allows the heat to circulate better.
- Use a meat thermometer for the most accurate doneness. Insert it so the tip is in the center of the largest muscle or thickest portion of the meat or poultry. Make sure the thermometer is not touching bone, fat, or the bottom of the pan.

BAKING/ROASTING (MODELS FEP310G, FEP320G, FEP330G)

1. Place the racks where you need them in the oven.

For more information, see “Positioning racks and pans” under “Using the oven” earlier in this section.

NOTE: Do not place food directly on the oven door or the oven bottom.

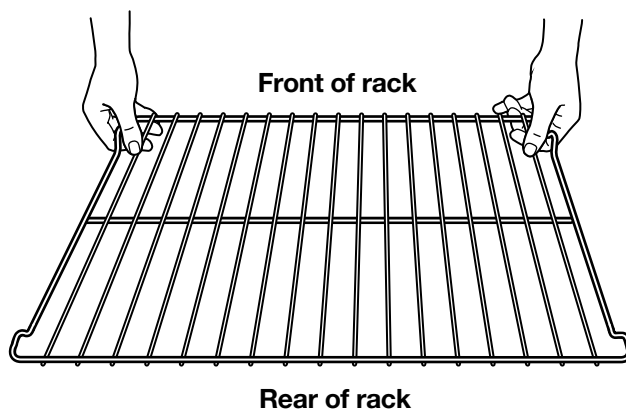

BAKING/ROASTING (MODELS FEP310G, FEP320G, FEP330G) (CONT.)

2. Set the oven selector to BAKE and the oven temperature control knob to the baking/roasting temperature you want.

The oven on indicator light will come on. The oven is preheated when the oven on indicator light first goes off.

NOTE: Do not preheat the oven when roasting.

TURN

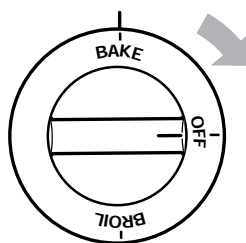

TURN

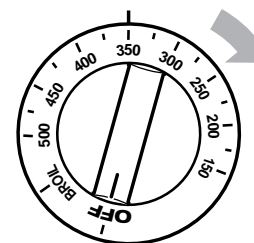

3. Put your food in the oven.

During baking/roasting, the elements will turn on and off to keep the oven temperature at the setting. The oven on indicator light will turn on and off with the elements.

NOTE: The top element helps heat during baking/roasting, but does not turn red.

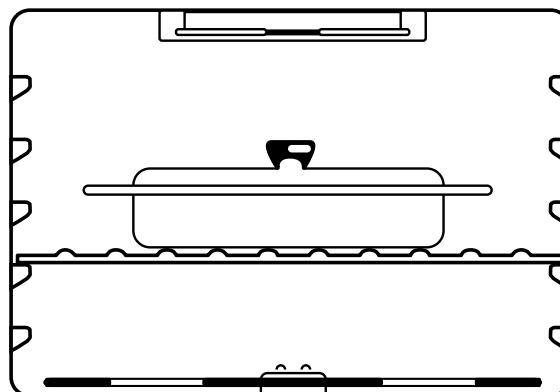

4. After cooking, turn off the oven.

Turn both the oven selector and the oven temperature control knob to OFF. The oven on indicator light will go off.

TURN

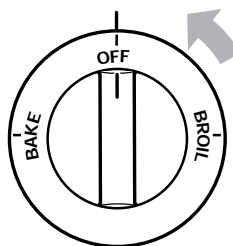

TURN

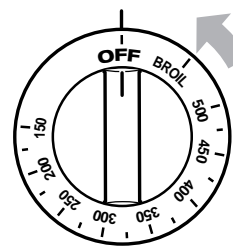

Saving energy

- To avoid loss of heat, open the oven door as little as possible.
- Use a timer to keep track of cooking time.
- Plan your meals for the most efficient use of the oven by cooking more than one food at a time, or baking while the oven is still hot after cooking a meal.

Roasting meats and poultry

- For even cooking, place the meat on a rack in a shallow pan. This keeps the meat out of the drippings and allows the heat to circulate better.
- Use a meat thermometer for the most accurate doneness. Insert it so the tip is in the center of the largest muscle or thickest portion of the meat or poultry. Make sure the thermometer is not touching bone, fat, or the bottom of the pan.

ADJUSTING THE OVEN TEMPERATURE CONTROL (MODEL FES330G)

Although your new oven is properly adjusted to provide accurate temperatures, it may cook faster or slower than your old oven.

If you are not satisfied with the baking/roasting results, you can change the offset temperature by following the steps below.

NOTE: DO NOT measure oven temperature with a thermometer. Opening the oven door will lower the oven temperature and give you an incorrect reading. Also, the thermometer temperature reading will change as your oven cycles.

- 1.** Press and hold CLOCK for 5 seconds.

The display will show the time of day. Then you will see the current offset temperature, for example "00," if you have not already adjusted the temperature.

PRESS



YOU SEE



(factory setting of "0")

- 2.** Set the new offset temperature.

Press ▲ to raise the temperature or ▼ to lower the temperature in 10°F amounts. You can set the temperature change to as low as -30°F or as high as +30°F. A minus (-) sign will appear before the number when decreasing the temperature setting. The minus sign shows the oven will be cooler by the displayed amount. There is no sign in front of the number when increasing the temperature setting.

PRESS



YOU SEE



(example when making oven 10°F cooler)

- 3.** Press CLOCK to enter the offset temperature.

PRESS



YOU SEE

(time of day or minute timer countdown)

How to determine the amount of adjustment needed

The chart at the right tells you how much to adjust the offset temperature to get the cooking results you want. You can figure out cooking results by the amount of browning, moistness, and rising times for baked foods.

TO COOK FOOD ...	ADJUST BY THIS NUMBER OF DEGREES (FAHRENHEIT)
A little more	+10
Moderately more	+20
Much more	+30
A little less	-10
Moderately less	-20
Much less	-30

ADJUSTING THE OVEN TEMPERATURE CONTROL (MODELS FEP310G, FEP320G, FEP330G)

Although your new oven is properly adjusted to provide accurate temperatures, it may cook faster or slower than your old oven.

If you are not satisfied with the baking/roasting results, you can change the temperature calibration by following the steps below.

NOTE: DO NOT measure the oven temperature with a thermometer. Opening the oven door will lower the oven temperature and give you an incorrect reading. Also, the thermometer temperature reading will change as your oven cycles.

1. Make sure the oven temperature control knob is turned to the off position. Pull the knob straight off and flip it over.

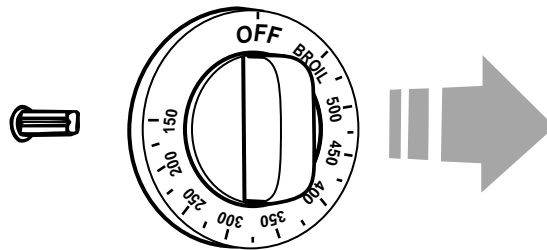

2. Loosen the locking screws inside the control knob. Note the position of the notches.

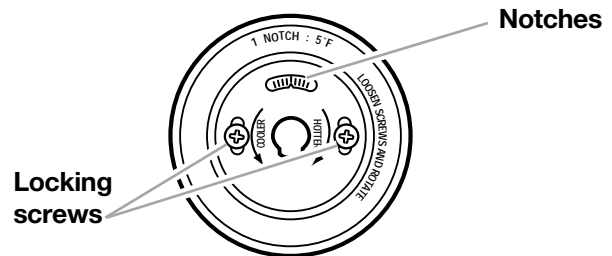

3. Adjust the temperature.
 - **To lower the temperature**, hold the knob handle firmly and turn the skirt **counterclockwise** to move the tooth a notch to the left.
 - **To raise the temperature**, hold the knob handle firmly and turn the skirt **clockwise** to move the tooth a notch to the right.

Each notch equals about 5°F.

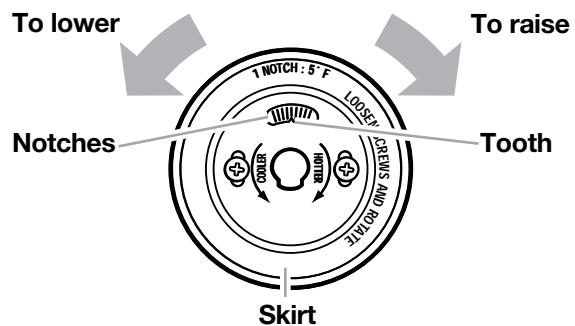

4. Tighten the locking screws and replace the control knob.

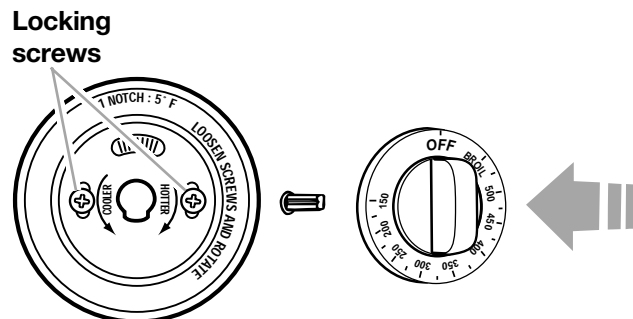

BROILING (MODEL FES330G)

NOTES:

- Do not preheat when broiling unless your recipe recommends it.
- Leave the door partly open whenever you use the oven to broil. This lets the oven stay at the proper temperatures.

1. Place the rack where you need it in the oven.
You need to place the rack so that the surface of the food is at least 3 inches away from the broil element. See the "Broiling guidelines" section.

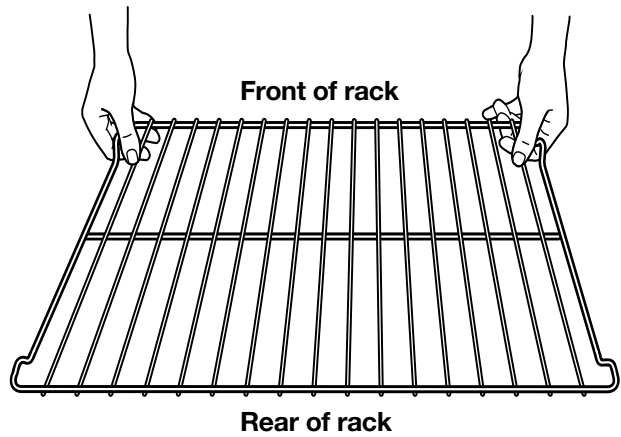

2. Put your food on the broiler pan and place the pan in the center of the oven rack.

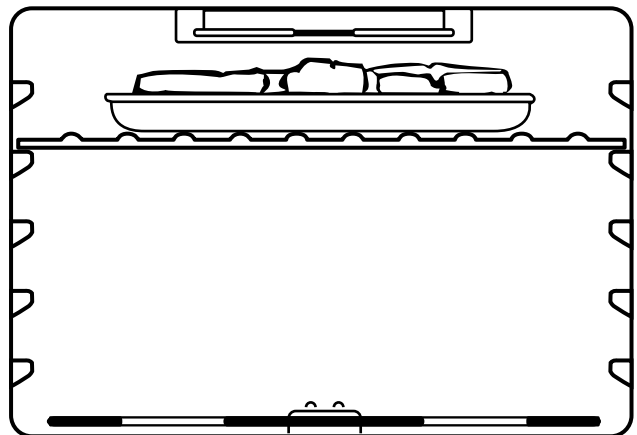

3. Close the door to the broil stop position.
The broil stop position lets the door stay open by itself about 5 inches.

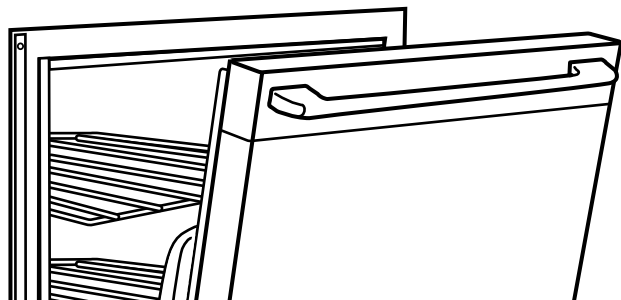

BROILING (MODEL FES330G) (CONT.)

4. Set the oven control knob to BROIL.

PUSH AND TURN

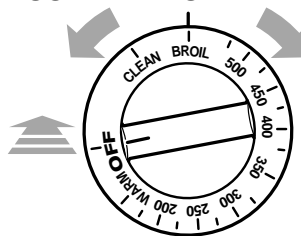

YOU SEE

OVEN ON and HEATING lights go on.

5. After broiling, turn the oven control knob to OFF.

PUSH AND TURN

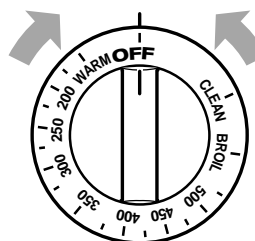

YOU SEE

OVEN ON and HEATING lights go out.

BROILING (MODELS FEP310G, FEP320G, FEP330G)

NOTES:

- Do not preheat when broiling unless your recipe recommends it.
- The oven selector must be on BROIL for broiling temperatures.
- Leave the door partly open whenever you use the oven to broil. This lets the oven stay at the proper temperatures.

1. Place the rack where you need it in the oven.
You need to place the rack so that the surface of the food is at least 3 inches away from the broil element. See the “Broiling guidelines” section.

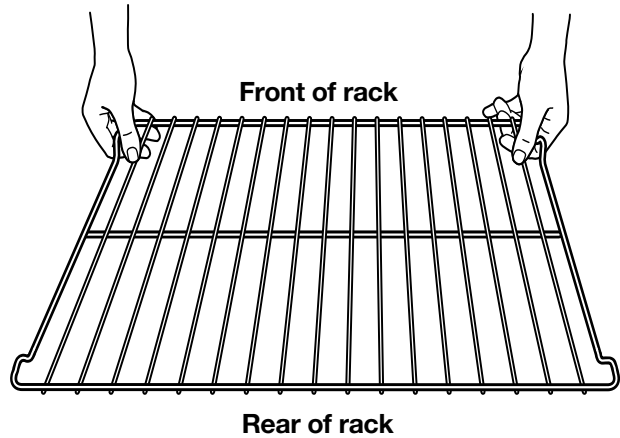

2. Put your food on the broiler pan and place the pan in the center of the oven rack.

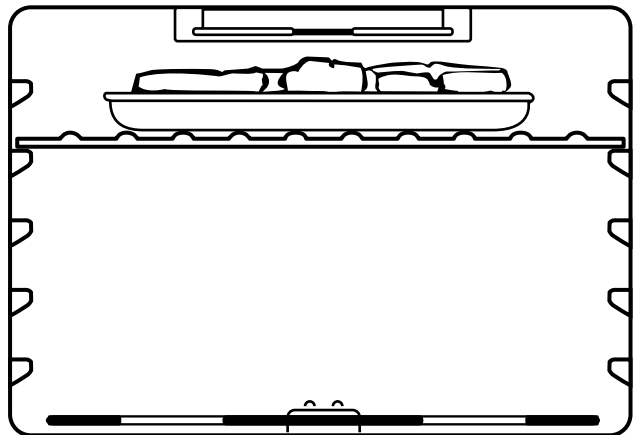

3. Close the door to the broil stop position.
The broil stop position lets the door stay open by itself about 5 inches.

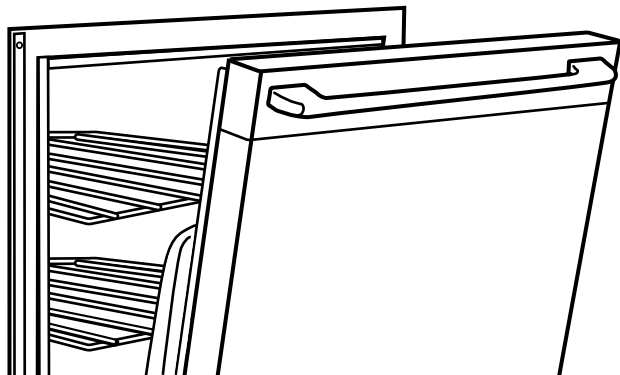

BROILING (MODELS FEP310G, FEP320G, FEP330G) (CONT.)

4. Set the oven selector and the oven temperature control knob to BROIL.
The oven on indicator light will come on.

TURN

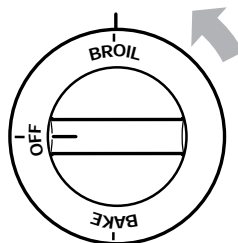

TURN

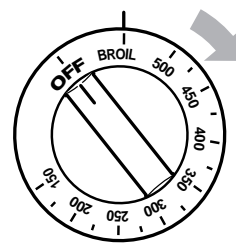

5. After broiling, turn off the oven.
Turn both the oven selector and the oven temperature control knob to OFF. The oven on indicator light will go off.

TURN

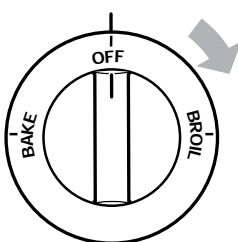

TURN

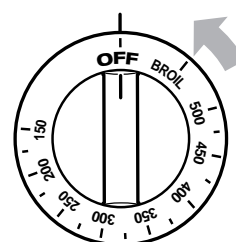

To broil at a lower temperature:

- If your food is cooking too fast, turn the oven temperature control knob **counterclockwise** until the oven on indicator light goes off.

TURN

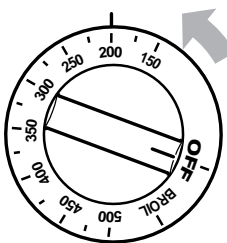

- If you want your food to broil slower from the start, set the oven temperature control knob between 170°F and 325°F. These temperature settings let the broil heating element cycle and slow cooking results. The lower the temperature, the slower the cooking.

TURN

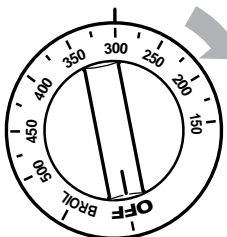

NOTE: Fish and chicken are some foods that may cook better if you use lower broiling temperatures.

BROILING (CONT.)

Broiling guidelines

- Use only the broiler pan and grid provided. They are designed to drain extra juices from the cooking surface. This drainage helps prevent spatter and smoke.
- To make sure the juices drain well, do not cover the grid with foil.
- Trim excess fat to reduce spattering. Slit the fat on the edges to prevent curling.
- Use tongs to turn meat to avoid losing juices.
- Pull out oven rack to stop position before turning or removing food.
- After broiling, remove the pan from the oven when removing the food. Drippings will bake on the pan if left in the heated oven, making cleaning more difficult.
- For easier cleaning, line the bottom of the pan with aluminum foil. Clean the pan and grid as soon as possible after each use.

Recommended rack positions are numbered from the bottom (1) to the top (5). For best results, place food 3 inches or more from the broil element.

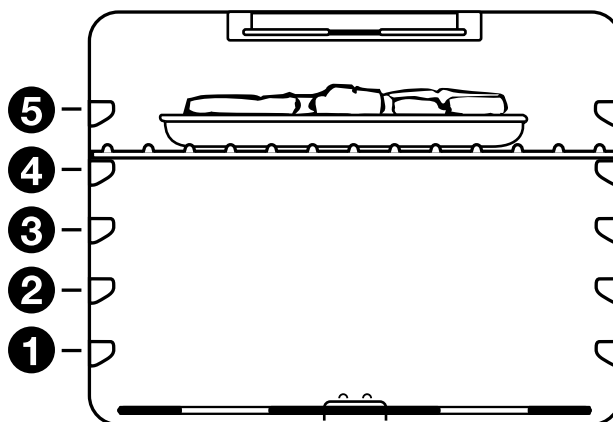

MEAT	RACK POSITION	APPROXIMATE TIME (MINUTES)	
		SIDE 1	SIDE 2
Steak, 1" thick	4		
medium rare		14-15	7-8
medium		15-16	8-9
well done		18-19	9-10
Hamburger Patties, 3/4" thick, 1/4 lb well done	4	13-14	7-8
Pork Chops, 1" thick	4	20-22	10-11
Ham Slice, 1/2" thick, precooked	4	8-10	4-5
Frankfurters	4	5-7	3-4
Lamb Chops, 1" thick	4	14-17	8-9
Chicken			
bone-in pieces	3	17-20	17-20
boneless breasts	4	11-16	11-16
Fish	4		
fillets 1/4-1/2" thick		8-10	4-5
steaks, 3/4-1" thick		16-18	8-9

NOTE: Times are guidelines only and may need to be adjusted for individual tastes.

THE OVEN VENT

Hot air and moisture escape from the oven through a vent under the left rear coil element. You can cook on this coil element or keep food warm on it while the oven is on. The vent is needed for air circulation. **Do not block the vent by using extra large pans or covers.** You will get poor baking/roasting results.

NOTE: Never leave plastic utensils over the vent. They could melt.

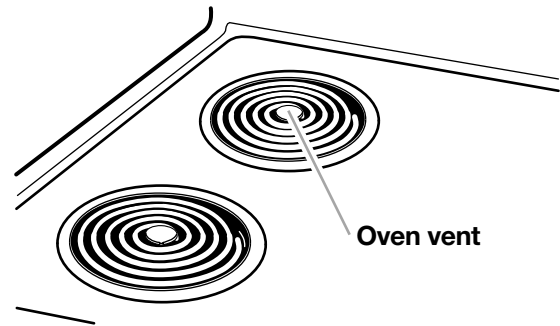

THE ANTI-TIP BRACKET

The range will not tip during normal use. However, the range can tip if you apply too much force or weight to the open door without the anti-tip bracket fastened down properly.

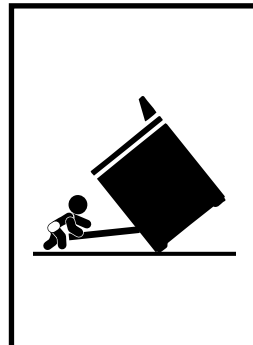

⚠️ WARNING

Tip Over Hazard

A child or adult can tip the range and be killed.
Connect anti-tip bracket to rear range foot.
Reconnect the anti-tip bracket, if the range is moved.
See the installation instructions for details.
Failure to follow these instructions can result in death or serious burns to children and adults.

Anti-Tip Bracket

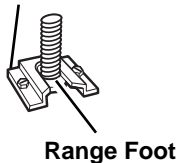

Making sure the anti-tip bracket is installed:

- Slide range forward.
- Look for the anti-tip bracket securely attached to floor.
- Slide range back so rear range foot is under anti-tip bracket.

THE STORAGE DRAWER

Use the storage drawer to store cookware. You can remove the storage drawer to make it easier to clean under your range.

Removing the storage drawer:

1. Empty the drawer before you remove it. Pull the drawer straight out to the first stop. (The stops are small, round objects formed in the slide rail. They keep the drawer from sliding all the way out.) Then lift the front of the drawer and pull it out to the second stop.
2. Lift the back of the drawer slightly and slide it all the way out.

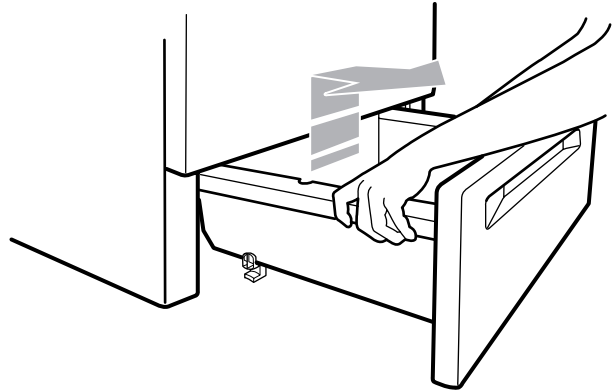

Replacing the storage drawer:

1. Position the drawer so that the lower drawer guides rest just inside the front frame lip.
2. Lift the front of the drawer and push it in until the metal stops on the drawer slide rails clear the upper drawer guides. Then slide the drawer closed.

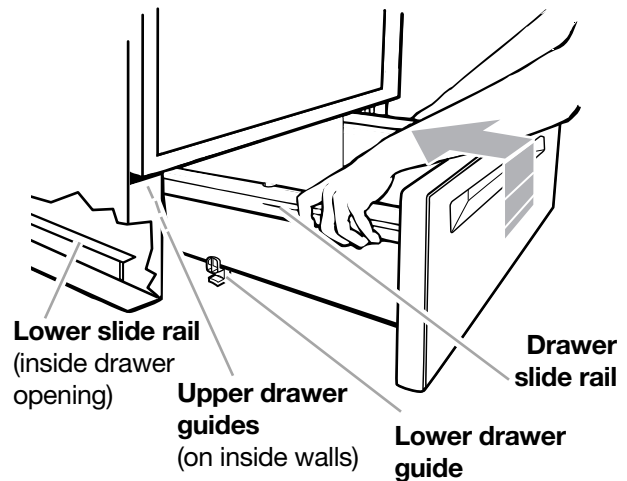

USING THE SELF-CLEANING CYCLE

(MODEL FES330G)

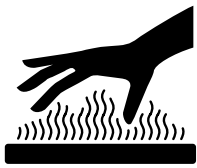

⚠️ WARNING

Burn Hazard

Do not touch the oven during the Self-Cleaning cycle.
Keep children away from oven during Self-Cleaning cycle.
Do not use commercial oven cleaners in your oven.
Failure to follow these instructions can result in burns, or illness from inhaling dangerous fumes.

BEFORE YOU START

Before you start the Self-Cleaning cycle, make sure you:

- Hand-clean the areas shown. They do not get hot enough during the Self-Cleaning cycle for soil to burn away. Use hot water and detergent or a soapy, steel-wool pad for cleaning.

NOTE: DO NOT clean, move, or bend the gasket. You may get poor cleaning, baking, and roasting.

- Do not let water, cleaner, etc., enter slots on door and frame.
- Remove the broiler pan and grid and any cookware/bakeware being stored in the oven.
- Wipe out any loose soil or grease. This will help reduce smoke during the Self-Cleaning cycle.
- Wipe up food spills containing sugar as soon as possible after the oven cools down. When sugar is heated to a high temperature in the Self-Cleaning cycle, the high temperature can cause the sugar to burn and react with the porcelain. This can cause staining and etching or pitting.
- Remove the oven racks from the oven if you want them to remain shiny. You can clean the oven racks in the Self-Cleaning cycle, but they will become harder to slide. (See the “Cleaning chart” in the “Caring for Your Range” section.) If you clean the racks in the Self-Cleaning cycle, place them on the 2nd and 4th rack guides. (The guides are counted from bottom to top.)
- Heat and odors are normal during the Self-Cleaning cycle. Keep the kitchen well ventilated by opening a window or by turning on a vent hood or other kitchen vent during the cycle.

IMPORTANT: The health of some birds is extremely sensitive to the fumes given off during the Self-Cleaning cycle. Move birds to another closed and well ventilated room.

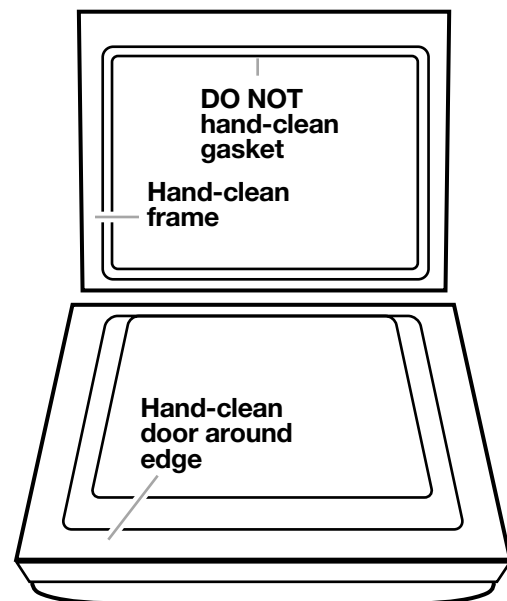

TIPS:

- Keep the kitchen well ventilated during the Self-Cleaning cycle to help get rid of heat, odors, and smoke.
- Clean the oven before it gets heavily soiled. Cleaning a very soiled oven takes longer and results in more smoke than usual.
- Do not block the vent during the Self-Cleaning cycle. Air must move freely for best cleaning results.
- Do not leave plastic utensils on the cooktop. They may melt.
- Do not leave any foil in the oven during the Self-Cleaning cycle. Foil could burn or melt and damage the oven surface.
- The oven light will not work during the Self-Cleaning cycle.

SETTING THE CONTROLS (MODEL FES330G)

- 1.** Set the oven control knob to CLEAN.

The door will lock itself within 6 seconds. If the door has a problem locking, it will try to lock itself for 1 minute. If the door fails to lock, the Self-Cleaning cycle will cancel. An error code will be displayed.

NOTE: Do not attempt to open the door while in the locking mode.

PUSH AND TURN

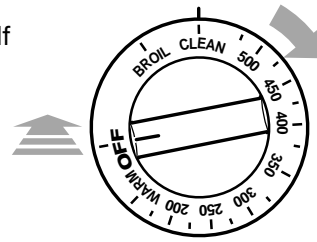

YOU SEE

OVEN ON light goes on. **DOOR LOCKED/CLEANING** light flashes until you close door, then is solid. **HEATING** light goes on when oven starts heating.

- 2.** Set the cleaning time (optional).

Press the “up” (▲) or “down” (▼) pad(s) to select a clean time between 2 hours, 30 minutes and 4 hours, 30 minutes.

NOTE: The Self-Cleaning cycle will automatically set a 3½ hour cycle unless a different time is selected.

PRESS



- 3.** During the last 30 minutes of the Self-Cleaning cycle the oven will start to cool down.

Once the oven goes below the locked temperature:

YOU SEE

OVEN ON and **DOOR LOCKED/CLEANING** lights are on. **HEATING** light goes off and **COOL** appears in display.

YOU SEE

OVEN ON light flashes. **DOOR LOCKED/CLEANING** light goes out when door unlocks.

- 4.** Turn the oven control knob to OFF.

TURN

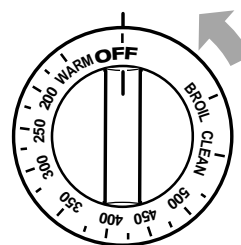

YOU SEE

OVEN ON light goes out and time of day appears in display.

- 5.** After the oven is cool, wipe off any residue or ash with a damp cloth or sponge.

If needed, touch up spots with a mild abrasive cleanser or cleaning sponge.

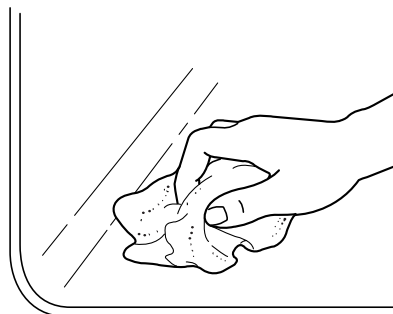

SETTING THE CONTROLS (MODEL FES330G) (CONT.)

To stop the self-cleaning cycle at any time:

Turn the oven control knob to OFF.

TURN

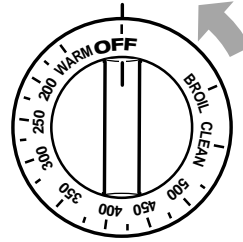

YOU SEE

DOOR LOCKED/ CLEANING light stays on. **COOL** appears in display until oven goes below locking temperature.

HOW THE CYCLE WORKS (MODEL FES330G)

The Self-Cleaning cycle uses very high heat to burn away soil and grease. During the cycle, the oven gets much hotter than it does for normal baking or broiling. This high heat breaks up the soil or grease and burns it away.

Your oven is automatically preset for a 3½-hour Self-Cleaning cycle.

The graph at the right shows you what happens in a 3½-hour Self-Cleaning cycle. Notice that the heating stops ½ hour before the 3½-hour setting is up.

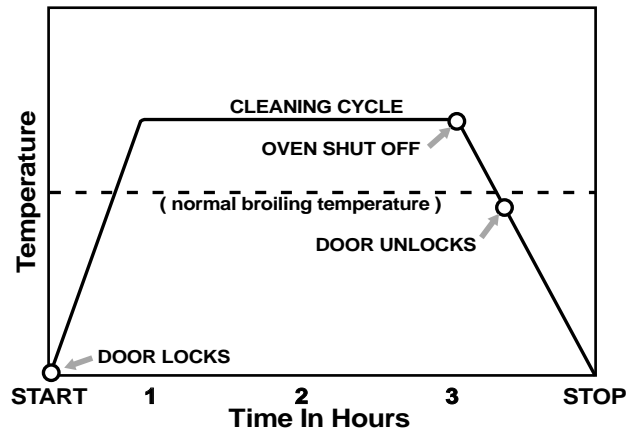

CARING FOR YOUR RANGE



! WARNING

Explosion Hazard

Do not store flammable materials such as gasoline near this appliance. Doing so can result in death, explosion, or fire.

CLEANING CHART

Before cleaning, always make sure all controls are off and the range is cool. Refer to instructions on all cleaning products before using them to clean your range.

PART	CLEANING METHOD	SPECIAL INSTRUCTIONS	
Control Knobs	<ul style="list-style-type: none"> • Soap and water • Dishwasher 	<ul style="list-style-type: none"> • DO NOT use steel wool or abrasive cleaners. • Pull knobs straight away from control panel. • Wash, rinse and dry with soft cloth. 	
Control Panel	<ul style="list-style-type: none"> • Soap and water • Spray glass cleaner 	<ul style="list-style-type: none"> • Wash, rinse and dry with soft cloth. • Apply spray cleaner to paper towel, do not spray directly on panel. 	
Exterior Surfaces* (excluding control panel and oven door glass)	<ul style="list-style-type: none"> • Soap and water • Mild liquid cleaner • Spray glass cleaner • Non-abrasive plastic scrubbing pad 	<ul style="list-style-type: none"> • DO NOT use abrasive or harsh cleaners like chlorine bleach, ammonia or oven cleaners. • Wash, rinse and dry with soft cloth. • Gently clean around the model and serial plate; too much scrubbing could remove the numbers. 	
Coil Elements		<ul style="list-style-type: none"> • DO NOT clean or immerse in water. Spatters and spills will burn off. 	
Chrome reflector bowls*	<ul style="list-style-type: none"> • Light to moderate soil • Heavy to burned-on soils 	<ul style="list-style-type: none"> • Soap and water • Non-abrasive plastic scrubbing pad • Dishwasher • Solution of 1/2 cup ammonia to 1 gallon water • Non-abrasive plastic scrubbing pad • Mild abrasive powdered cleanser or commercial oven cleaner 	<ul style="list-style-type: none"> • Wash, rinse and dry with soft cloth. • Soak bowls for 20 minutes, then scrub with plastic pad.

*When the cooktop is cool, remove all spills and clean. Food spills containing acids, such as vinegar and tomato, may affect the finish.

CLEANING CHART (CONT.)

PART	CLEANING METHOD	SPECIAL INSTRUCTIONS
Surface under cooktop <ul style="list-style-type: none"> • Light to moderate soil • Heavy soils 	<ul style="list-style-type: none"> • Soap and water • Soapy steel wool pad 	<ul style="list-style-type: none"> • Wash, rinse and dry with soft cloth. • Rinse thoroughly and dry.
Oven door glass (Models FEP320G, FEP330G and FES330G)	<ul style="list-style-type: none"> • Soap and water • Non-abrasive plastic scrubbing pad • Spray glass cleaner 	<ul style="list-style-type: none"> • Wash, rinse and dry with soft cloth. • Wipe with paper towel.
Oven cavity (Models FEP310G, FEP320G and FEP330G) <ul style="list-style-type: none"> • Food spills containing sugar and/or milk • Heavily soiled areas 	<ul style="list-style-type: none"> • Soap and water • Steel wool pad • Commercial oven cleaner 	<ul style="list-style-type: none"> • When oven cools, wash, rinse and dry with soft cloth. • Wipe with clean water and dry well. • Follow the directions that come with the oven cleaner. (Place newspaper on the floor to protect the floor surface.) Wipe well with clean water and dry. <p>NOTES:</p> <ul style="list-style-type: none"> • Use oven cleaners in a well-ventilated room. • Do not let commercial oven cleaners contact the gasket, thermostat, or exterior surfaces of the range. This will cause damage. • For easier cleaning, you can remove the oven door. Carefully follow the instructions in the "Removing the oven door" section.
Oven cavity (Model FES330G) <ul style="list-style-type: none"> • Food spills containing sugar and/or milk • All other spills 	<ul style="list-style-type: none"> • Soap and water • Self-cleaning cycle 	<ul style="list-style-type: none"> • When oven cools, wash, rinse and dry with soft cloth or sponge. • See the "Using the self-cleaning cycle" section.
Oven racks (Models FEP310G, FEP320G and FEP330G)	<ul style="list-style-type: none"> • Soap and water • Steel wool pad 	<ul style="list-style-type: none"> • Wash, rinse and dry.
Oven racks (Model FES330G)	<ul style="list-style-type: none"> • Soap and water • Steel wool pad • Self-cleaning cycle 	<ul style="list-style-type: none"> • Wash, rinse and dry. • Place on 2nd and 4th rack guides. Racks will discolor and become harder to slide. After cleaning, apply vegetable oil to rack guides for easier sliding.
Broiler pan and grid	<ul style="list-style-type: none"> • Soap and water • Steel wool pad • Dishwasher • Solution of 1/2 cup ammonia to 1 gallon water • Mildly abrasive cleanser or commercial oven cleaner 	<ul style="list-style-type: none"> • Wash, rinse and dry. • Soak for 20 minutes, then scrub with plastic scrubbing pad.

COIL ELEMENTS AND REFLECTOR BOWLS

Removing

1. Make sure all coil elements are off and cool before removing coil elements and reflector bowls.

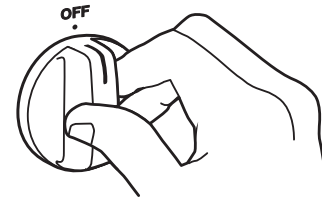

2. Push in the edge of the coil element, opposite the receptacle. Then lift it just enough to clear the reflector bowl.

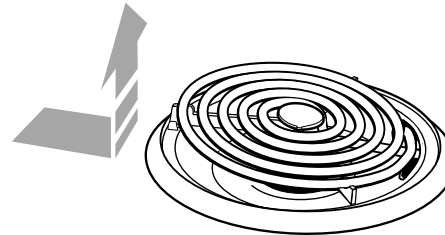

3. Pull the coil element straight away from the receptacle.

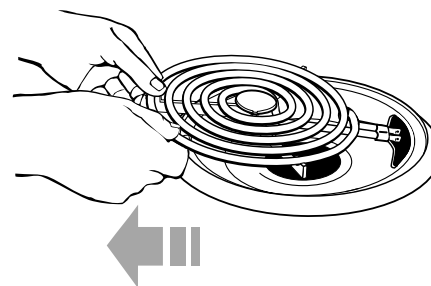

4. Lift out the reflector bowl. See the "Cleaning chart" earlier in this section for cleaning instructions.



Replacing

1. Make sure all coil elements are off and cool before replacing coil elements and reflector bowls.

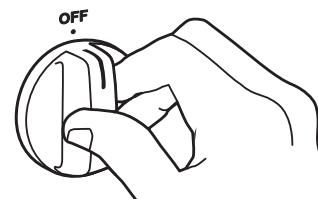

COIL ELEMENTS AND REFLECTOR BOWLS (CONT.)

2. Line openings in the reflector bowl with the coil element receptacle.



3. Hold the coil element as level as possible with the terminal just started into the receptacle. Push the coil element terminal into the receptacle.

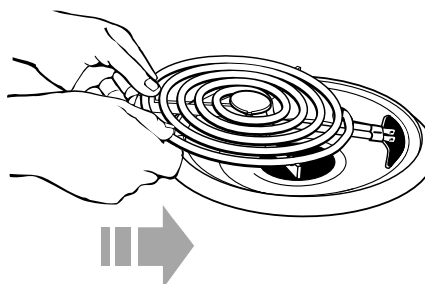

4. When the terminal is pushed into the receptacle as far as it will go, push down the edge of the coil element opposite the receptacle.

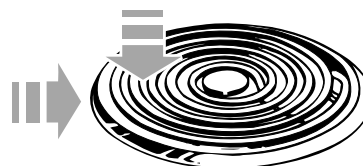

NOTE: Reflector bowls reflect heat back to the cookware on the coil elements. They also help catch spills. When they are kept clean, they reflect heat better and look new longer.

If a reflector bowl changes color, some of your cookware may not be flat enough, or some may be too large for the coil element. In either case, some of the heat that is meant to go into or around cookware goes down and heats the reflector bowl. This extra heat can cause it to change color.

LIFT-UP COOKTOP

NOTE: Do not drop the cooktop. Damage could result to the porcelain and the cooktop frame.

1. Lift the front of the cooktop at both front corners until the support rods lock into place.
2. Wipe the surface under the cooktop with warm, soapy water and a sponge. Use a soapy steel-wool pad on heavily soiled areas.
3. To lower the cooktop, lift the cooktop from both sides while pressing the support rods back to unlock them. Lower the cooktop into place.

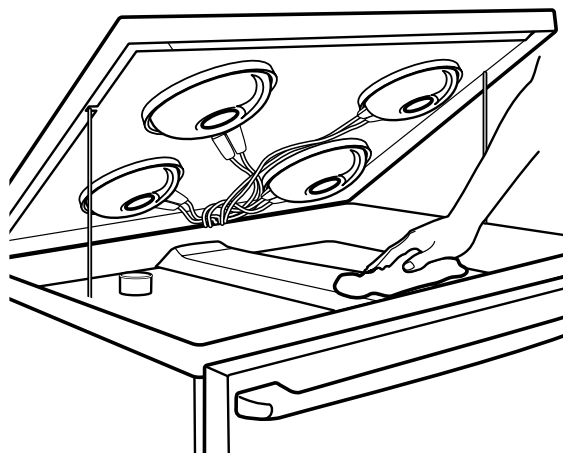

REMOVING THE OVEN DOOR

For normal use of your range, you do not need to remove the door. However, if you find it necessary to remove the door, follow the instructions in this section.

NOTE: The oven door is heavy.

Before removing the door:

1. Use a putty knife or screwdriver and insert it at the bottom corner of the door stop clip.
2. Pry door stop clip free and remove from front frame hinge slot. Take care not to scratch porcelain.
3. Repeat procedure for other door stop clip.

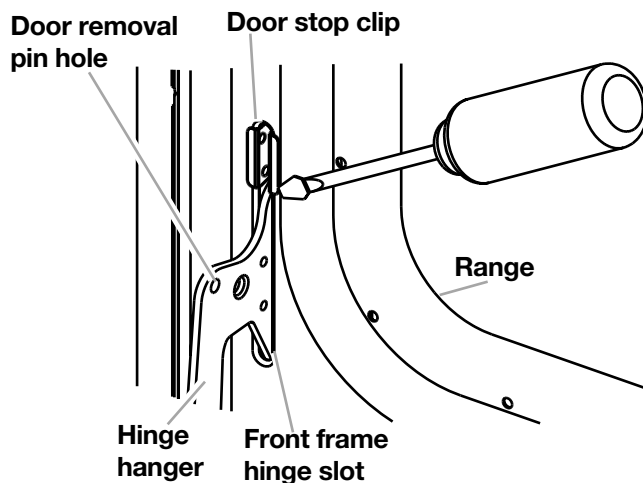

To remove:

1. Open the oven door. Insert door removal pins, included with your range, into both hinge hangers. **Do not remove the pins while the door is removed from the range.**

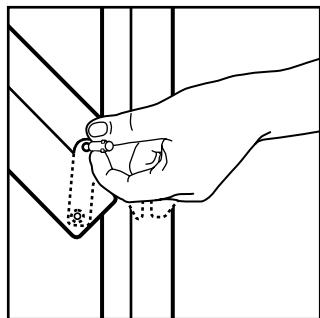

2. Carefully close the door until it rests against the door removal pins.

3. Grasp the door on the sides with your fingers on the front of the door and your thumbs on the inside surface.

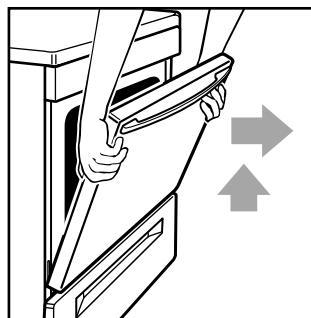

4. Pull door straight up, then toward you. Hinge hangers will slide out of front frame hinge slot.

To replace:

NOTE: The door removal pins you inserted must still be in both hinges.

1. Grasp the door on the sides with your fingers on the front of the door and your thumbs on the inside surface.

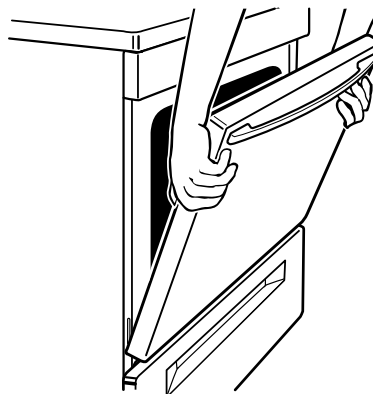

REMOVING THE OVEN DOOR (CONT.)

2. Hold oven door so that the top edge of each hinge hanger is horizontal. Insert hinge hangers into the front frame hinge slots.

3. Rotate top of door toward range. Slide hinge hangers down onto front frame support pins.

NOTE: Make sure the hinge hangers are fully seated and engaged on the support pins.

4. Insert the door stop clip with the angular surface at the top of the frame hinge slot, then push in the bottom of the clip until flanges are flush with the front frame.

5. Open the door completely and remove the door removal pins. Save door removal pins for future use.

6. Close the door.

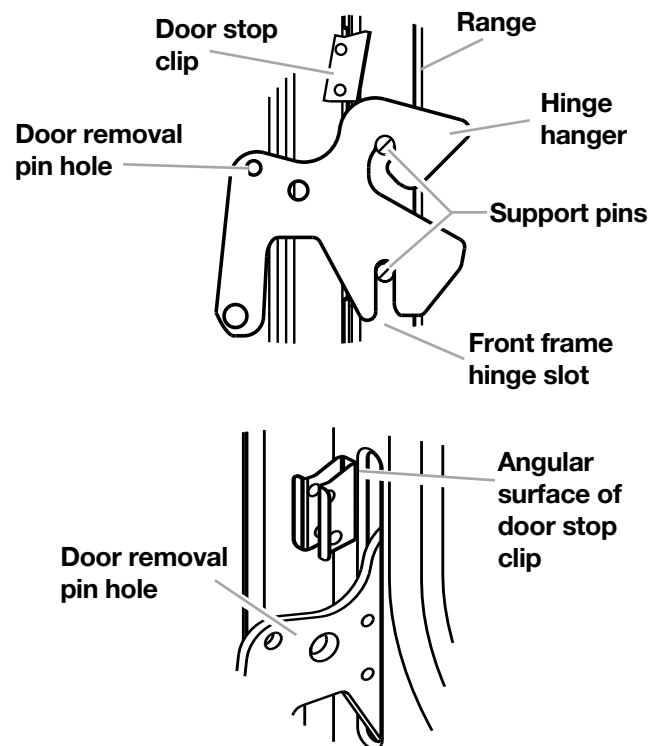

TROUBLESHOOTING

Most cooking problems often are caused by little things you can find and fix without tools of any kind. Check the lists below and on the next page before calling for assistance or service. If you still need help, see “Requesting Assistance or Service” on page 37.

RANGE DOES NOT WORK

PROBLEM	CAUSE
Nothing works	<ul style="list-style-type: none">● The range is not plugged into a properly grounded live outlet with the proper voltage. (See Installation Instructions.)● You have blown a household fuse or tripped a circuit breaker.● The control knob is not set correctly. Push in the control knobs before turning them.
The oven does not work	<ul style="list-style-type: none">● You have not turned the oven temperature control knob to a temperature setting.● You have not set the oven selector to BAKE or BROIL (Models FEP310G, FEP320G, FEP330G).
The coil elements will not work	<ul style="list-style-type: none">● You have blown a household fuse or tripped a circuit breaker.● The coil elements are not plugged in all the way (See “Replacing” on page 31.)● You have not set the control knobs correctly. Push the control knobs in before turning them to a setting.

WHEN SELF-CLEANING YOUR OVEN (MODEL FES330G)

PROBLEM	CAUSE
The Self-Cleaning cycle will not work	<ul style="list-style-type: none">● You did not turn the oven control knob to CLEAN.● The door is not closed all the way.

COOKING RESULTS

PROBLEM	SOLUTION
Cookware not level on cooktop (Check to see if liquids are level in cookware)	<ul style="list-style-type: none"> ● Level the range. (See the Installation Instructions.) ● Insert coil correctly. ● Use cookware with a flat bottom.
Excessive heat on cooktop in areas around cookware	<ul style="list-style-type: none"> ● Choose cookware the same size or slightly larger than the element.
The oven temperature seems too low or too high	<ul style="list-style-type: none"> ● Adjust the oven temperature control. (See “Adjusting the oven temperature control” section.)
Slow baking or roasting	<ul style="list-style-type: none"> ● Increase baking or roasting time. ● Increase temperature 25° F. ● Preheat oven to selected temperature before placing food in when preheating is recommended. ● Choose bakeware that will allow 2 inches of air space around all sides. ● Open oven door to check food when timer signals shortest time suggested in recipe. ● Oven peeking can make cooking times longer.
Baked items too brown on bottom	<ul style="list-style-type: none"> ● Preheat oven to selected temperature before placing food in oven. ● Choose bakeware that will allow 2 inches of air space around all sides. ● Position rack higher in oven. ● Decrease oven temperature 15° to 25° F.
Unevenly baked items	<ul style="list-style-type: none"> ● Level the range. ● Bake in center of oven with 2 inches of space around each pan. ● Check to make sure batter is level in pan.
Crust edge browns before pie is done	<ul style="list-style-type: none"> ● Shield edge with foil.

INDICATOR LIGHTS FLASH (MODEL FES330G)

PROBLEM	CAUSE
The oven on and heating indicator lights flash	<ul style="list-style-type: none"> ● You cannot bake, broil, or clean. Call for service. (See “If You Need Assistance or Service” on page 37.)
The heating and door locked/cleaning indicator lights flash	<ul style="list-style-type: none"> ● The door lock has failed. Call for service. (See “If You Need Assistance or Service” on page 37.)

If none of these items are causing your problem, see “Requesting Assistance or Service” on page 37.

REQUESTING ASSISTANCE OR SERVICE

To avoid unnecessary service calls, please check the “Troubleshooting” section. It may save you the cost of a service call. If you still need help, follow the instructions below.

IF YOU NEED ASSISTANCE OR SERVICE

Call our Consumer Assistance Center at 1-616-923-7113. Our consultants are available to assist you.



When calling:

Please know the purchase date, and the complete model and serial number of your appliance (see the “A Note to You” section). This information will help us better respond to your request.

Our consultants provide assistance with:

- Features and specifications on our full line of appliances
- Installation information
- Use and maintenance procedures

- Accessory and repair parts sales
- Specialized customer assistance (Spanish speaking, hearing impaired, limited vision, etc.)
- Referrals to local dealers, service companies, and repair parts distributors

To locate an authorized service company in your area, you can also look in your telephone directory Yellow Pages.

IF YOU NEED REPLACEMENT PARTS

If you need to order replacement parts, we recommend that you only use FSP® factory authorized parts. FSP replacement parts will fit right and work right, because they are made to the same exacting specifications used to build every new ROPER® appliance.

To locate FSP replacement parts in your area, call our Consumer Assistance Center telephone number or your nearest authorized service center.

FOR FURTHER ASSISTANCE

If you need further assistance, you can write to us with any questions or concerns at:

Roper Brand Home Appliances
Consumer Assistance Center
c/o Correspondence Dept.
2000 North M-63
Benton Harbor, MI 49022-2692

Please include a daytime phone number in your correspondence.

INDEX

TOPIC	PAGE	TOPIC	PAGE
ANTI-TIP BRACKET	25	ELECTRONIC TIME-OF-DAY CLOCK/TIMER (MODELS FEP330G and FES330G)	
ASSISTANCE	38	Clock	14
BAKING		Display	13
Aluminum foil	13	Timer	14, 15
Bakeware	12	FEATURES	6-8
Pans	12	LIFT-UP COOKTOP	33
Racks	11, 12	MODEL AND SERIAL NUMBER	2
Setting cycle (Model FES330G)	15, 16	OVEN DOOR	34, 35
Setting cycle (Models FEP310G, FEP320G and FEP330G) ..	16, 17	OVEN TEMPERATURE	
Tips	16, 17	Adjusting	18, 19
BROILING		Setting (Model FES330G)	15, 21
Grid	20, 22	Setting (Models FEP310G, FEP320G and FEP330G)	17, 23
Guidelines	24	OVEN VENT	25
Pan	20, 22, 24	PANS	12
Rack positions	24	PARTS	6-8
Setting cycle (Model FES330G)	20, 21	RACKS	11, 12
Setting cycle (Models FEP310G, FEP320G and FEP330G) ..	22, 23	ROASTING	
CLEANING		Pans	12
Broiler pan and grid	31	Racks	11, 12
Coil elements	30, 32, 33	Setting cycle (Model FES330G)	15, 16
Control knobs	30	Setting cycle (Models FEP310G, FEP320G and FEP330G) ..	16, 17
Control panel	30	Tips	16, 17
Exterior surfaces	30	SAFETY	3-5
Oven cavity	31	SELF-CLEANING CYCLE (MODEL FES330G)	
Oven door glass	31	Before you start	27
Oven racks	31	How the cycle works	29
Reflector bowls	30, 32, 33	Setting the controls	28
Self-cleaning cycle (Model FES330G)	27, 28, 29	Tips	27
Surface under cooktop	31	SERVICE	38
COIL ELEMENTS		STORAGE DRAWER	26
Coil element marker	6-8	TROUBLESHOOTING	36, 37
Control knobs	6-9	WARRANTY	40
Control setting guide	9		
Surface heating indicator light	7-8		
CONTROL PANEL			
Coil element marker	6-8		
Control knobs	9		
Oven on indicator light	6-8		
Surface heating indicator light	7, 8		
COOKWARE			
Canning	10		
Materials	11		
Tips	10		

WARRANTY

ROPER® ELECTRIC RANGE

LENGTH OF WARRANTY	WE WILL PAY FOR
FULL ONE-YEAR WARRANTY FROM DATE OF PURCHASE	FSP® replacement parts and repair labor to correct defects in materials or workmanship. Service must be provided by an authorized Roper service company.
WE WILL NOT PAY FOR	
<p>A. Service calls to:</p> <ol style="list-style-type: none"> 1. Correct the installation of your range. 2. Instruct you how to use your range. 3. Replace house fuses or correct house wiring. 4. Replace owner-accessible light bulbs. <p>B. Repairs when your range is used in other than normal, single-family household use.</p> <p>C. Pickup and delivery. Your range is designed to be repaired in the home.</p> <p>D. Damage to your range caused by accident, misuse, fire, flood, acts of God, or use of products not approved by us.</p> <p>E. Repairs to parts or systems resulting from unauthorized modifications made to the appliance.</p>	

3/98

THIS ROPER APPLIANCE IS WARRANTED BY WHIRLPOOL CORPORATION. UNDER NO CIRCUMSTANCES SHALL IT BE LIABLE UNDER THIS WARRANTY FOR INCIDENTAL OR CONSEQUENTIAL DAMAGES. Some states do not allow the exclusion or limitation of incidental or consequential damages, so this exclusion or limitation may not apply to you. This warranty gives you specific legal rights, and you may also have other rights which vary from state to state.

Outside the United States, a different warranty may apply. For details, please contact your authorized Roper dealer.

If you need service, first see the "Troubleshooting" section of this book. After checking "Troubleshooting," additional help can be found by checking the "Requesting Assistance or Service" section or by calling 1-616-923-7113 from anywhere in the U.S.A.

Free Manuals Download Website

<http://myh66.com>

<http://usermanuals.us>

<http://www.somanuals.com>

<http://www.4manuals.cc>

<http://www.manual-lib.com>

<http://www.404manual.com>

<http://www.luxmanual.com>

<http://aubethermostatmanual.com>

Golf course search by state

<http://golfingnear.com>

Email search by domain

<http://emailbydomain.com>

Auto manuals search

<http://auto.somanuals.com>

TV manuals search

<http://tv.somanuals.com>