

**ROPER**<sup>®</sup>

Home Appliances

# Use And Care

## GUIDE



A Note To You 2

Important Safety Instructions 3

Parts And Features 6

Using Your Range 7

Caring For Your Range 17

If You Need Assistance Or Service 25

Warranty 28

**1-800-44-ROPER**

Call us with questions or comments.

### STANDARD-CLEANING GAS RANGE

TO THE INSTALLER: PLEASE LEAVE THIS INSTRUCTION BOOK WITH THE UNIT.

TO THE CONSUMER: PLEASE READ AND KEEP THIS BOOK FOR FUTURE REFERENCE.

**MODELS FGP320A FLP320A  
FLP310Y FGP320Y  
FGP325Y**

# A Note To You

## Thank you for buying a Roper® appliance.

Your Roper® range gives you all the functionality of name brand appliances at a value price. To ensure that you enjoy years of trouble-free operation, we developed this Use and Care Guide. It is full of valuable information about how to operate and maintain your appliance properly and safely. Please read it carefully. Also, please complete and mail the Ownership Registration Card provided with your appliance. This will help us notify you about any new information on your appliance.

## Your safety is important to us.

This guide contains safety symbols and statements. Please pay special attention to these symbols and follow any instructions given. Here is a brief explanation of the use of each symbol.

### **⚠ WARNING**

This symbol will help alert you to such dangers as personal injury, burns, fire and electrical shock.

### **⚠ CAUTION**

This symbol will help you avoid actions which could cause product damage (scratches, dents, etc.) and damage to your personal property.

	<h3><b>⚠ WARNING</b></h3> <ul style="list-style-type: none"><li>• ALL RANGES CAN TIP.</li><li>• INJURY TO PERSONS COULD RESULT.</li><li>• INSTALL ANTI-TIP DEVICES PACKED WITH RANGE.</li><li>• SEE INSTALLATION INSTRUCTIONS.</li></ul>
--	--

For further information, see "The anti-tip brackets" on page 16.

## **Our toll-free number, 1-800-44-ROPER (1-800-447-6737), is available 24 hours a day.**

If you ever have a question concerning your appliance's operation, or if you need service, first see "If You Need Assistance Or Service" on page 25. If you need further help, feel free to call us. When calling, you will need to know your appliance's complete model number and serial number. You can find this information on the model and serial number plate (see diagram on page 6). For your convenience, we have included a handy place below for you to record these numbers, the purchase date from the sales slip and your dealer's name and telephone number. Keep this book and the sales slip together in a safe place for future reference.

**Model Number** \_\_\_\_\_

**Dealer Name** \_\_\_\_\_

**Serial Number** \_\_\_\_\_

**Dealer Phone** \_\_\_\_\_

**Purchase Date** \_\_\_\_\_

# Important Safety Instructions

## READ AND SAVE THESE INSTRUCTIONS

Gas ranges have been thoroughly tested for safe and efficient operation. However, as with any appliance, there are specific installation and safety precautions which must be followed to ensure safe and satisfactory operation.

### **⚠ WARNING**

To reduce the risk of fire, electrical shock, injury to persons, or damage when using the range, follow basic precautions, including the following:

**WARNING:** If the information in this manual is not followed exactly, a fire or explosion could result causing property damage, personal injury or death.

**Do not store or use gasoline or other flammable vapors and liquids in the vicinity of this or any other appliance.**

#### **WHAT TO DO IF YOU SMELL GAS:**

- Do not try to light any appliance.
- Do not touch any electrical switch; do not use any phone in your building.
- Immediately call your gas supplier from a neighbor's phone. Follow the gas supplier's instructions.
- If you cannot reach your gas supplier, call the fire department.

**Installation and service must be performed by a qualified installer, service agency or the gas supplier.**

#### **General**

- Install or locate the range only in accordance with the provided Installation Instructions. The range must be installed by a qualified installer. The range must be properly connected to the proper gas supply and checked for leaks. The range must also be properly connected to electrical supply and grounded.
- Gas fuels and their use in appliances can cause minor exposures to benzene, formaldehyde, carbon monoxide and soot, primarily from incomplete combustion. Significant exposure to these substances could cause cancer or reproductive harm. Properly adjusted burners with a blue, rather than a yellow, flame will minimize incomplete combustion. Venting with a hood or an open window will further minimize exposure.

continued on next page

## IMPORTANT SAFETY INSTRUCTIONS

- Do not store things children might want above the range. Children could be burned or injured while climbing on it.
- Do not leave children alone or unattended in area where the range is in use. They should never be allowed to sit or stand on any part of the range. They could be burned or injured.
- Do not operate the range if it is damaged or not working properly.
- Do not use the range for warming or heating the room. Persons could be burned or injured, or a fire could start.
- Do not attempt to light the oven burner on electric ignition models during a power failure. Personal injury could result. Reset oven controls to the off position in the event of a power failure.
- Use the range only for its intended use as described in this manual.



- Do not touch surface burners, areas near surface burners or interior surfaces of oven. Areas near surface burners and interior surfaces of an oven become hot enough to cause burns. During and after use, do not touch, or let clothing or other flammable materials contact surface burners, areas near surface burners or interior surfaces of oven until they have had sufficient time to cool. Other surfaces of the range, such as the oven vent opening, the surface near the vent opening, the cooktop, and the oven door, could also become hot enough to cause burns.



- Do not wear loose or hanging garments when using the range. They could ignite if they touch an open flame and you could be burned.
- Use only dry potholders. Moist or damp potholders on hot surfaces could result in burns from steam. Do not let potholder touch an open flame. Do not use a towel or bulky cloth for a potholder. It could catch on fire.
- Keep range vents unobstructed.
- Do not heat unopened containers. They could explode. The hot contents could cause burns and container particles could cause injury.
- Do not store flammable materials on or near the range. The fumes could create an explosion and/or fire hazard.
- Do not use the oven for storage.
- Do not use aluminum foil to line area around surface burners, oven bottom, or any other part of the range. Use aluminum foil only as recommended in this manual.
- Never use a match or other flame to look for a gas leak. Explosion and injury could result.
- Know where your main gas shutoff valve is located.

### **When using the cooktop**

- Make sure the utensils you use are large enough to contain food and avoid boilovers and spillovers. Heavy splattering or spillovers left on a range could ignite and burn you. Pan size is especially important in deep fat frying.

## IMPORTANT SAFETY INSTRUCTIONS

- Check to be sure glass cooking utensils are safe for use on the range. Only certain types of glass, glass-ceramic, ceramic, earthenware or other glazed utensils are suitable for cooktops without breaking due to the sudden change in temperature.
- Never leave surface burners unattended at high heat settings. A boilover could result and cause smoking and greasy spillovers that could ignite.



- Turn pan handles inward, but not over other surface burners. This will help reduce the chance of burns, igniting of flammable materials, and spills due to bumping of the pan.
- Do not use decorative covers or trivets over the surface burners.

### When using the oven

- Always position the oven rack(s) in desired location while oven is cool.
- Use care when opening oven door. Let hot air or steam escape before removing or replacing food.

### Grease

- Grease is flammable. Do not allow grease to collect around cooktop or in vents. Wipe spillovers immediately.



- Do not use water on grease fires. Never pick up a flaming pan. Smother flaming pan by covering with a well-fitted lid, cookie sheet or flat tray. Flaming grease outside of pan can be extinguished with baking soda or, if available, a multipurpose dry chemical or foam-type extinguisher.

### Care and cleaning

- Do not clean door heat seal. It is essential for a good seal. Care should be taken not to rub, damage or move the seal. Clean only parts recommended in this Use and Care Guide.
- Do not repair or replace any part of the range unless specifically recommended in this manual. All other servicing should be referred to a qualified technician.
- Any additions, changes or conversions required in order for this appliance to satisfactorily meet the application needs must be made by a Roper Distributor or Qualified Agency.
- On some models, disconnect the electrical supply before servicing the range. On all models, disconnect the gas supply at the shutoff valve near the range before servicing.

– READ AND SAVE THESE INSTRUCTIONS –

# Parts And Features

This section contains captioned illustrations of your range. Use them to become familiar with the location and appearance of all parts and features.

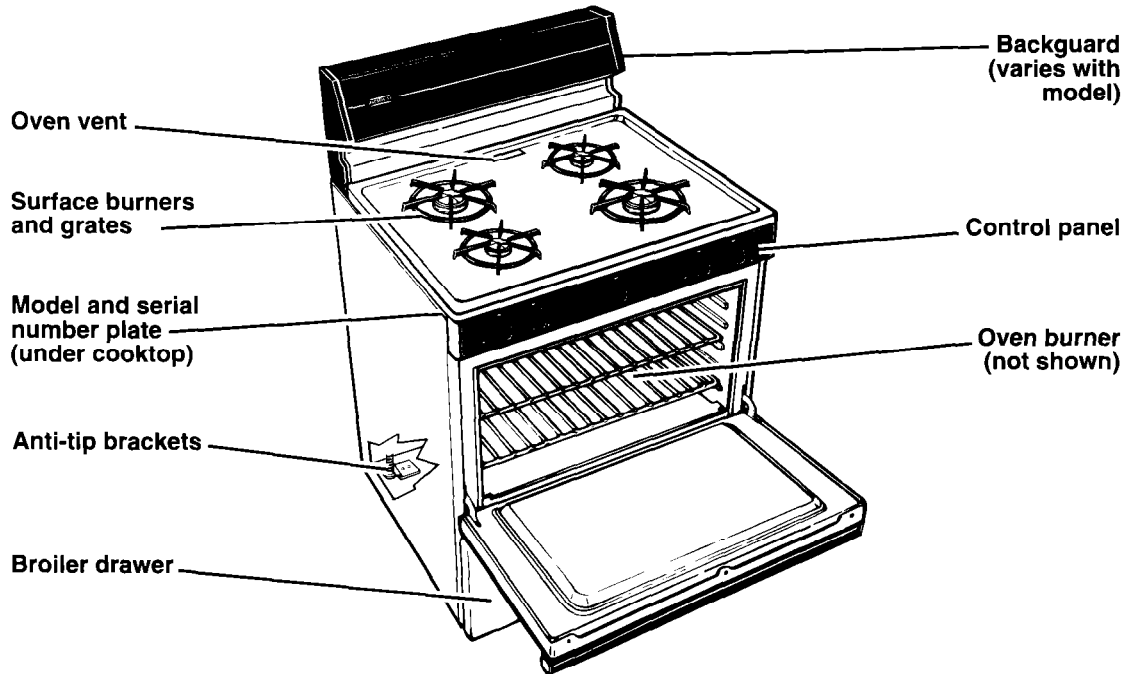

## Control panel

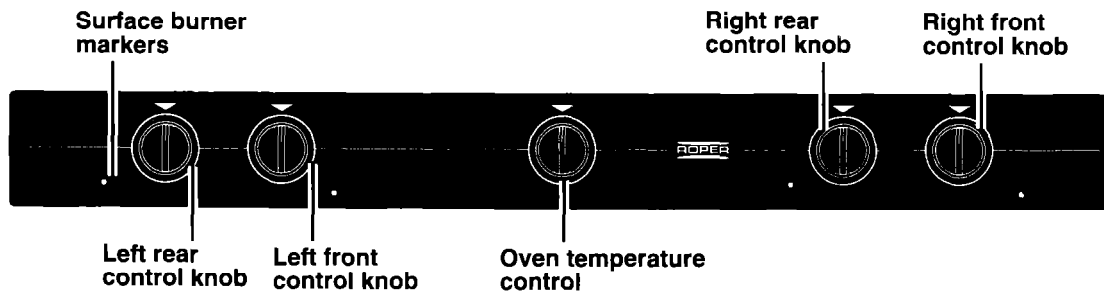

# Using Your Range

## In This Section

	Page		Page
Using the surface burners .....	7	Adjusting the oven temperature control .....	13
Positioning racks and pans .....	9	Broiling .....	14
For best air circulation .....	10	Energy saving tips .....	15
Lighting standing pilots .....	11	The oven vent .....	15
Baking/roasting .....	12	The anti-tip brackets .....	16

To obtain the best cooking results possible, you must operate your range properly. This section gives you important information for efficient and safe use of your range.

## Using the surface burners

Your range is equipped with either standing pilots or electric ignitors. Standing pilots must be lit initially with a match following the directions on page 11. The pilot light will remain lit when the burners are turned off. To turn a burner on again, just **push in and turn** the control knob to LITE and the burner will light. Electric ignitors automatically light the burners each time the control knob is turned to LITE.

**Push in the control knob and turn counterclockwise** to the LITE position. On electric ignitor models, the clicking sound is the ignitor sparking. **Visually check that burner has lit.**

**After the burner lights, turn** the control knob to the desired setting. You can set the control knob anywhere between HI and LO.

### Surface burner markers

The solid dot in the surface burner marker shows which surface burner is turned on by that knob.

### Burner heat settings

**Use** correct burner heat settings (see next page). If the heat setting is too high, it can:

- **Char** bacon and cause curling.
- **Make** eggs tough and crisp at the edges.
- **Toughen** liver, fish and seafood.
- **Scorch** delicate sauces and custards.
- **Cause** a boilover.

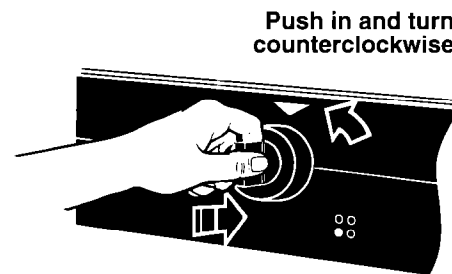

## USING YOUR RANGE

Until you get used to the settings, use the following as a guide. For best results, start cooking at the high setting; then turn the control knob down to continue cooking.

SETTING	RECOMMENDED USE
LITE	<ul style="list-style-type: none"><li>To light the burner. After the burner lights, turn control back to a desired setting.</li></ul>
HI	<ul style="list-style-type: none"><li>To start foods cooking.</li><li>To bring liquids to a boil.</li></ul>
Medium	<ul style="list-style-type: none"><li>To hold a rapid boil.</li><li>To fry chicken or pancakes.</li><li>For gravy, pudding and icing.</li><li>To cook large amounts of vegetables.</li></ul>
LO	<ul style="list-style-type: none"><li>To keep food warm until ready to serve.</li></ul>

**NOTE:** Do not cook with the control in the LITE position.

### In case of a prolonged power failure

Surface burners with electric ignitors can be manually lighted. **Hold** a lit match near a burner and slowly **turn** the control knob on until the burner lights. **After the burner lights, turn** the control knob to the desired setting. Power failures will not affect standing pilots. **Do not attempt to operate an electric ignition oven during a power failure.**

## ⚠ WARNING

### Burn, Fire, and Explosion Hazard

- Burner flame should not extend beyond the edge of the cooking utensil. The flame could burn you and cause poor cooking results.
- Be sure all control knobs are turned to OFF when you are not cooking. Someone could be burned or a fire could start if a burner is accidentally left ON.
- If the flame should go out while cooking, or if there is a strong gas odor, turn the burners OFF. Wait five minutes for the gas odor to disappear before relighting burner. If gas odor is still present, see safety note on page 3. Failure to follow these precautions could result in explosion or fire.

### Product Damage Hazard

Do not leave an empty utensil, or one which has boiled dry, on a hot surface burner.

The utensil could overheat and could damage the utensil or cooking product.

### Cookware tips

No one brand of cookware is best for all people. Knowing something about pan materials and construction will help you select the correct cookware for your needs.

- **NOTE: For best results and greater fuel efficiency,** use only flat-bottomed cookware in good condition.
- **The pan** should have straight sides and a tight-fitting lid.
- **Choose medium to heavy gauge** (thickness) pans that are fairly lightweight.
- **The pan material** (metal or glass) affects how fast heat transfers from the surface burners through the pan material and how evenly heat spreads over the pan bottom. Choose pans that provide the best cooking results.
- **Handles** should be made of a sturdy, heat-resistant material and be securely attached to the pan.



- **Pans** should be easy to clean. Check to be sure there are no crevices, rough edges or areas where food might collect.
- **Be sure pans** do not tip, whether they are full or empty.
- **Use cookware** only as it was intended to be used. Follow pan instructions. This is very important for glass cookware because some should be used only in the oven. Other pans are marked as flameware and may be used on the surface burners.

## Home canning information

The larger diameter of most water-bath or pressure canners combined with high heat settings for long periods of time can cause damage to the cooktop.

### To protect your range:

- **For best results**, use a canner which can be centered over the surface burner.
- **Do not place canner** on two surface burners at the same time. Too much heat will build up and will damage the cooktop.
- **Start with hot water**. This reduces the time the control is set on high. Reduce heat setting to lowest position needed to keep water boiling.
- **Refer to your canner manual** for specific instructions.

## Positioning racks and pans

**For baking/roasting with one rack**, place the rack so the top of the food will be centered in the oven.

### Rack placement for specific foods:

FOOD	RACK POSITION
Frozen pies, large roasts, turkeys	1st or 2nd rack guide from bottom
Angel and bundt cakes, most quick breads, yeast breads, casseroles, meats	2nd rack guide from bottom
Cookies, biscuits, muffins, cakes, nonfrozen pies	2nd or 3rd rack guide from bottom

**When baking on two racks**, arrange racks on first and third rack guides from bottom.

## ⚠ WARNING

### Personal Injury Hazard

- Always position oven rack(s) in desired location before turning oven on. Be sure the rack(s) is level.
- If rack(s) must be moved while oven is hot, use potholders or oven mitts to protect hands.
- Do not place items on the open oven door.
- Be careful when installing and removing large food items from extra roasting rack position. Food will be close to hot surfaces, including oven bottom and sides.

Failure to follow the above precautions could result in personal injury.

continued on next page

### Extra oven rack position (roasting rack)

When roasting food too large to be placed in oven with rack in lowest position, **place** rack on bottom of oven.

**For proper roasting, follow these guidelines:**

- **The rack** must be level.
- **Use** adequate amount of liquid (meat juices or water) so food does not get overdone.
- **Do not try to pull** rack out over door. Rack will be at the same level as door when door is opened.

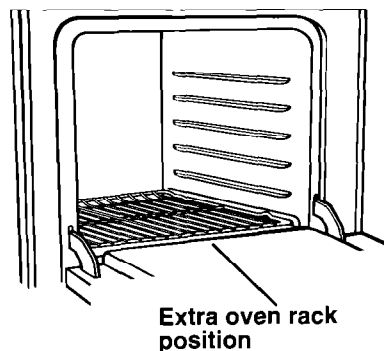

---

### For best air circulation

Hot air must circulate around the pans in the oven for even heat to reach all parts of the oven. This results in better baking.

- **Place** the pans so that one is not directly over the other.
- **For best results, allow** 1½-2 inches (4-5 cm) of space around each pan and between pans and oven walls. There must be a minimum space of 1 inch (2.5 cm).
- **Use** only one cookie sheet in the oven at one time.

**Use the following as a guide to determine where to place the pans:**

#### One pan

Place in the center of the oven rack.

#### Two pans

Place in opposite corners of the oven rack.

#### Three or four pans

Place in opposite corners on each oven rack. Stagger pans so no pan is directly over another.

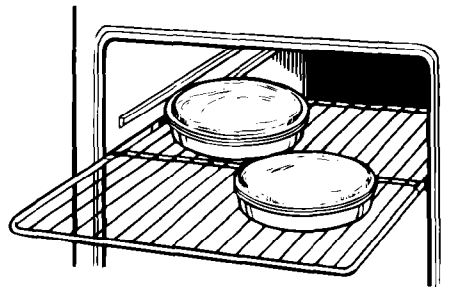

## Lighting standing pilots

(models FGP320Y, FGP320A, FLP320A, and FLP310Y)

### To light range pilots:

1. **Make sure** all controls are turned off.
2. **Remove** the surface burner grates from the cooktop. **Lift** the cooktop. (See "Lift-up cooktop" on page 18.)

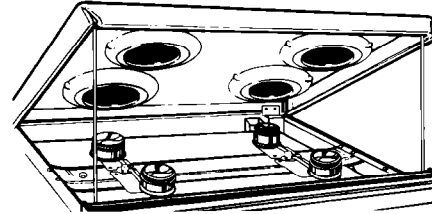

3. **To light, hold** a lit match over the pilot light located between the front and back burners. The pilot flame should be  $\frac{1}{4}$  to  $\frac{3}{8}$  in (.6-1 cm) high.

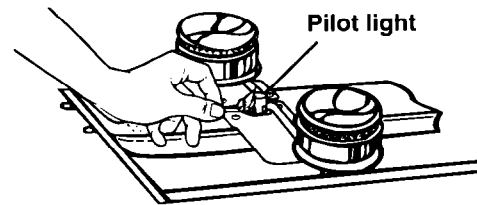

4. **If the pilot flame needs adjustment, turn** the pilot adjustment screw midway down the length of the manifold pipe, behind the control panel.
5. **Lower** the cooktop and **replace** the grates before using the surface burners.

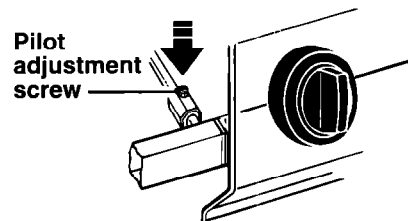

### To light oven burner pilot:

1. **Make sure** the Oven Temperature Control is turned off.
2. **Remove** the oven bottom (see "Removing the oven bottom" on page 21). Then **unscrew** the burner baffle located on the burner (see Installation Instructions for more information about the baffle).
3. **Hold** a lit match over the oven burner pilot located at the rear of the burner.
4. **After the oven burner pilot is burning steadily, check** burner lighting by turning the Oven Temperature Control to a temperature above 140°F (60°C). The burner will take 50-60 seconds to light.
5. **Replace** the burner baffle and oven bottom.

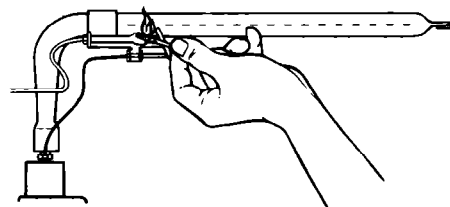

## Baking/roasting

**NOTE:** Do not attempt to light the oven burner on electric ignition models during a power failure. See "Important Safety Instructions" on page 4 for more information.

1. **Position** the rack(s) properly **before** turning on the oven. **To change rack position, lift** rack at front and **pull out**. For further information, **see** "Positioning racks and pans" on page 9.
2. **Push in and turn** the Oven Temperature Control **counterclockwise** to the baking/roasting temperature you want. The oven burner will automatically light in 50-60 seconds.
3. **When baking, preheat** the oven for 10 minutes. **Put** food in the oven.

### NOTES:

- **Do not preheat** when roasting or cooking items such as casseroles.
  - **Do not place** food directly on the oven bottom.
4. **During baking/roasting**, the oven burner will turn on and off to maintain the temperature setting.

5. **When baking/roasting is done**, turn the Oven Temperature Control **clockwise** to OFF.

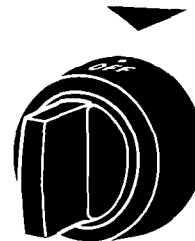
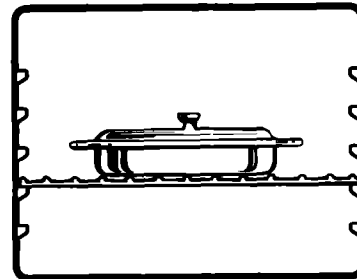
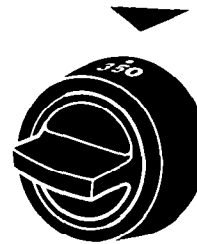

## Adjusting the oven temperature control

Oven temperature controls will gradually shift after years of use. So, even though your new oven is properly adjusted to provide accurate temperatures, it may cook faster or slower than your old oven.

If, after using the oven for a period of time, you are not satisfied with the temperature settings, you can adjust them by following these steps:

1. **Make sure** the Oven Temperature Control Knob is turned to the off position. **Pull** knob straight off and **flip** it over.

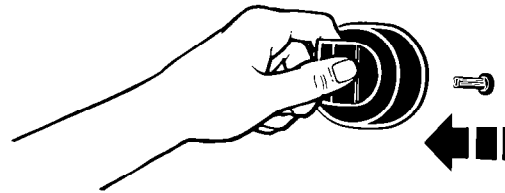

2. **Loosen** the locking screws inside the control knob. **Note the position of the notches.**
3. **To lower the temperature, hold** knob handle firmly and **move** the tooth a notch **clockwise**. Each notch equals about 20°F (11°C).
4. **To raise the temperature, hold** knob handle firmly and **move** the tooth a notch **counterclockwise**. Each notch equals about 20°F (11°C).
5. **Tighten** the locking screws and **replace** the control knob.

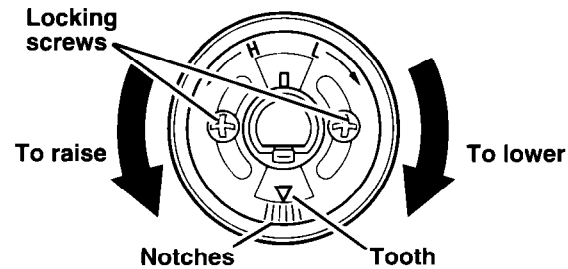

## Broiling

The broiler drawer is located below the oven door. **Always broil with the oven door closed.**

1. **Pull** the broiler drawer open and **tilt** the door panel down.

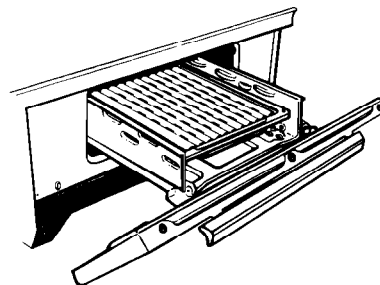

2. **Place** broiler pan grid so grease can drain down ribbing and through slots into lower part of the broiler pan. **See** picture.
3. **Before the broiler is turned on, place** food on broiler pan and **position** the broiler pan at one of the three levels.

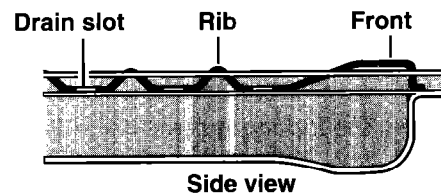

4. **Close** broiler drawer.
5. **Push in and turn** the Oven Temperature Control **counterclockwise** to BROIL. The broiler will automatically light in 50-60 seconds.



6. **When broiling is done, turn** the Oven Temperature Control **clockwise** to OFF.

**NOTE:** Do not preheat the broiler before using. Completely close the broiler drawer during broiling.

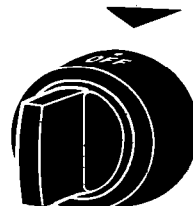

## Energy saving tips

Although the energy used for cooking is usually a very small percentage of the total energy used in the home, cooking energy can be used efficiently. Here are some tips to help you save energy when using your cooking product:

- **Use** pans with flat bottoms, straight sides and tight-fitting lids.
- **Cook** with a minimum of liquid or fat to help shorten cooking time.
- **Preheat** pans only when recommended and for the shortest time possible.
- **Start** food on higher heat settings, then set surface burner control on low to finish cooking.
- **Use** the more efficient surface burners instead of the oven when possible.
- **Turn on** the surface burner only after placing filled pan on the burner grate.
- **“Oven peeking”** may cause heat loss, longer cooking times and unsatisfactory baking results. Rely on your timer to keep track of the cooking time.
- **Bake** cakes, pies or cookies when oven is warm. Best time to bake is right after a meal has been cooked in the oven.
- **Preheat** the oven no longer than necessary.
- **Plan** your meals for the most efficient use of the range. When using the oven to cook one food, try to cook the rest of the meal in it also.
- **Do not preheat** when broiling, roasting or cooking items such as casseroles.

## The oven vent

Hot air and moisture escape from the oven through a vent located under the backguard. The vent is needed for air circulation. **Do not block the vent.** Poor baking/roasting will result.

**NOTE:** Never store plastics, paper or other items that could melt or burn near the oven vent, or any of the surface burners.

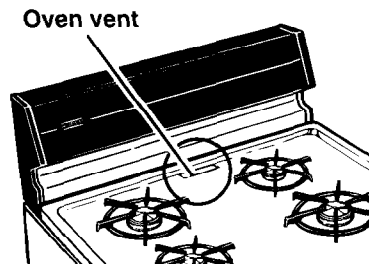

### **⚠ WARNING**

#### **Burn Hazard**

When the oven is ON, pans and pan handles left near the oven vent could become hot enough to burn the user and to melt plastics. Use potholders to move pans.

## The anti-tip brackets

The range will not tip during normal use. However, tipping can occur if you apply too much force or weight to the open door without the anti-tip brackets properly secured.

	<p style="text-align: center;"><b>⚠ WARNING</b></p> <p style="text-align: center;"><b>Personal Injury Hazard</b></p> <ul style="list-style-type: none"><li>• To reduce risk of range tipping over, secure range with properly installed anti-tip brackets supplied with range.</li><li>• If range is moved for cleaning or service, check that anti-tip devices are engaged before using range.</li></ul> <p>Failure to follow the above precautions could result in personal injury.</p>
---	---

### To verify the anti-tip brackets are engaged:

- **Grasp** rear of range and carefully try to tilt forward. If anti-tip brackets are attached to floor with screws and rear leveling legs are positioned under brackets (one for each rear leveling leg), range should not tilt forward.
- **See** Installation Instructions for further details.

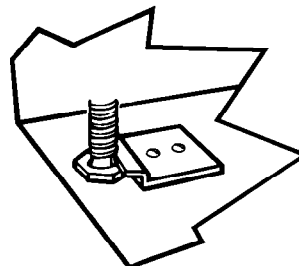



# Caring For Your Range

## In This Section

	Page	Page	
Surface burner grates .....	17	Removing the oven door .....	20
Lift-up cooktop .....	18	Removing the oven bottom .....	21
Surface burners .....	19	Cleaning chart .....	22

Your range is designed for easy care. You can do most cleaning with items found around your home. Cleaning your range whenever spills or soiling occurs will help to keep it looking and operating like new.

## **⚠ WARNING**

### **Burn, Electrical Shock, Fire and Explosion Hazard**

- Make sure all controls are OFF and the range is cool before cleaning.
- Do not use oven cleaners, bleach or rust removers.
- Do not obstruct the flow of combustion and ventilation air.
- Keep appliance area clear and free of combustible materials, gasoline and other flammable vapors and liquids.

Failure to follow these guidelines could result in burns, electrical shock, fire or explosion.

## Surface burner grates

1. **Make sure** all surface burners are off and the surrounding parts are cool.
2. **Lift off** the surface burner grates.
3. **Wash** the grates with warm, soapy water or in a dishwasher. **Use** a nonabrasive, plastic scrubbing pad for cooked-on foods. **Rinse** and **dry** well.
4. **Replace** burner grates.

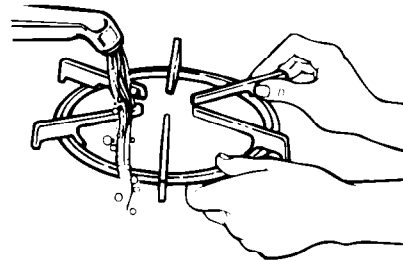

## Lift-up cooktop

1. **Remove** surface burner grates.
2. **Lift** front of cooktop at both front corners until the support rods lock into place.

### **⚠ WARNING**

#### **Personal Injury Hazard**

Be sure both support rods are fully extended and in the locked position. Failure to do so could result in personal injury from the cooktop accidentally falling.

#### **Product Damage Hazard**

Do not drop the cooktop. Damage could result to the porcelain and the cooktop frame.

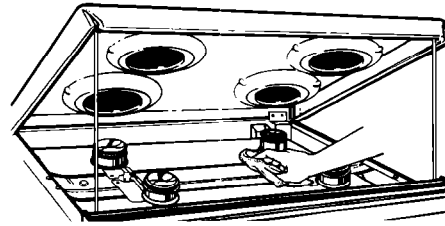

3. **Wipe** with warm, soapy water. **Use** a soapy steel-wool pad on heavily soiled areas.

**NOTE:** When cleaning under the cooktop on standing pilot models, be careful not to extinguish pilots.

4. **To lower the cooktop, lift** cooktop from both sides while pressing the support rods back to unlock them. **Lower** the cooktop into place. **Replace** surface burner grates.

## Surface burners

1. **Lift up** the cooktop, following the instructions above.
2. **Before cleaning, remove** screws that hold each of the burners in place. The screws prevent the burners from moving during shipment. **Remove** the shipping screws with a Phillips screwdriver, **lift** the burner up, **tilt** it to one side at the end closest to the ignitor and **move** it toward the back of the range. This separates the burner from the gas valve at the front of the range, so it can be easily removed.
3. **Wipe off** surface burners with warm, soapy water and a sponge after each use. **To remove cooked-on food, soak** the burners in a vinegar and water solution for 20-30 minutes. **Scrub** with a plastic scrubbing pad.
4. **If ports are clogged, clean with a straight pin. DO NOT enlarge or distort the ports. DO NOT use a toothpick to clean the ports.**
5. **Before putting the burners back, dry** them thoroughly by setting them in a warm oven for 30 minutes.
6. **Replace** burners, making sure they are properly seated and level. **Replace** screws.
7. **Occasionally check** the burner flames for proper size and shape as shown. A good flame is blue in color. If flames lift off ports, are yellow, or are noisy when turned off, you may need to clean the burners (see above), or call a qualified technician for adjustment.

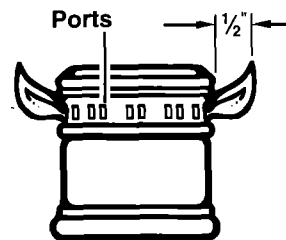
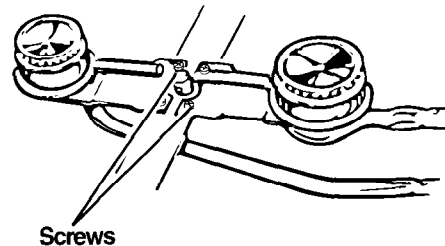

Typical surface burner flame at the highest setting

## Removing the oven door

Removing the oven door will help make it easier to clean the oven.

### **⚠ WARNING**

#### **Burn and Electrical Shock Hazard**

Make sure all controls are OFF and the oven is cool before removing oven door.

Failure to do so could result in burns or electrical shock.

#### **To remove:**

1. **Open** the door as far as it will go.
2. **Remove** the screws on each side of the oven door.
3. **Close** the door about  $\frac{3}{4}$  of the way.
4. **Lift** the door up and off the hinges.

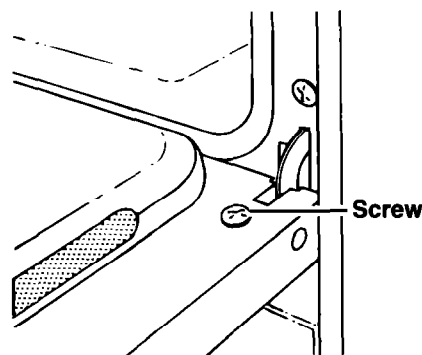

#### **To replace:**

1. **Be sure** the hinge arms are in the open position. **Be careful** if pulling the hinges open by hand. Hinges may snap back against the oven frame and could pinch fingers.
2. **Hold** the door at the sides near the top. **Insert** hinge arms into slots at the bottom of the door. **Insert** arms evenly, as far as they will go.
3. If the door is not in line with the oven frame, **remove** it and **repeat** the above steps.
4. **Replace** the screws on the oven door.

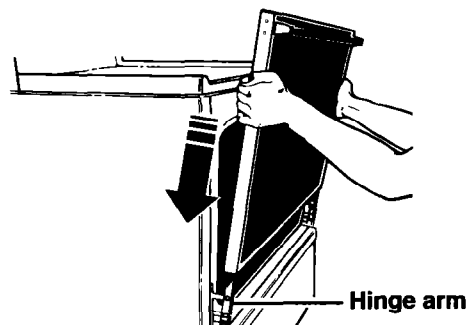

## Removing the oven bottom

The panel in the oven bottom can be removed for cleaning or to light the burner pilot.

### **⚠ WARNING**

#### **Burn Hazard**

Make sure all parts are cool before removing.  
Failure to do so could result in burns.

### **To remove:**

1. **Remove** oven racks.
2. **Remove** the two hold-down screws at the rear of the oven. If screws are too tight to remove by hand, **use** a screwdriver.

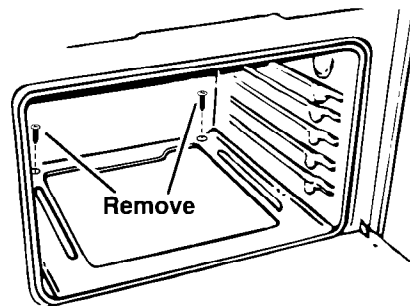

3. **Place** fingers in slots in bottom panel and **lift** rear of panel up and back until lip at the front of panel is clear of front frame of oven cavity.
4. **Lift** bottom up and out.

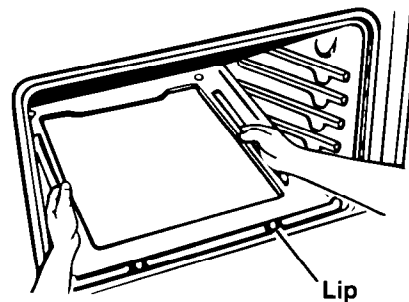

### **To replace:**

1. **Place** oven bottom panel in oven with the back raised about 6 inches or until you can insert the hold-down lip at front of panel under the front frame of oven cavity.
2. **Push** back of oven bottom panel down fully into place on metal flanges on rear wall and **insert** the hold-down screws.

## Cleaning chart

Use the following table to help you clean all parts of your range.

PART	WHAT TO USE	HOW TO CLEAN
<b>Control knobs</b>	Sponge and warm, soapy water	<ul style="list-style-type: none"> <li>• Turn knobs to OFF and pull straight away from control panel.</li> <li>• Wash, rinse and dry thoroughly. Do not soak.</li> <li>• <b>Do not use steel wool or abrasive cleansers. They may damage the finish of the knobs.</b></li> <li>• Replace knobs. Make sure all knobs point to OFF.</li> </ul>
<b>Control panel</b>	Sponge and warm, soapy water <b>OR</b> Paper towel and spray glass cleaner	<ul style="list-style-type: none"> <li>• Wash, rinse and dry thoroughly.</li> <li>• <b>Do not use steel wool or abrasive cleansers. They may damage the finish.</b></li> <li>• Do not spray cleaner directly on panel. Apply cleaner to paper towel.</li> </ul>
<b>Exterior surfaces</b> (other than control panel)	Sponge and warm, soapy water	<ul style="list-style-type: none"> <li>• Wash, rinse and dry thoroughly.</li> <li>• Use nonabrasive, plastic scrubbing pad on heavily soiled areas.</li> <li>• <b>Do not use abrasive or harsh cleansers. They may damage the finish.</b></li> </ul> <p><b>NOTE:</b> Do not allow foods containing acids (such as vinegar, tomato or lemon juice) to remain on surface. Acids may remove the glossy finish. Also wipe up milk or egg spills when cooktop is cool.</p>
<b>Surface burner grates</b>	Dishwasher <b>OR</b> Warm, soapy water and a nonabrasive, plastic scrubbing pad	<ul style="list-style-type: none"> <li>• In dishwasher, wash with other cooking utensils.</li> <li>• Dry completely.</li> <li>• <b>Do not use abrasive or harsh cleansers.</b></li> </ul>

PART	WHAT TO USE	HOW TO CLEAN
<b>Surface burners</b>	<p>Sponge and warm, soapy water</p> <p>Warm, soapy water and a nonabrasive, plastic scrubbing pad <b>OR</b> Vinegar and water solution</p>	<ul style="list-style-type: none"> <li>• Lift up the cooktop. (See page 18.)</li> <li>• Wipe off spills immediately after burner has cooled.</li> </ul> <p><b>For cooked-on food:</b></p> <ul style="list-style-type: none"> <li>• Remove burner from manifold with Phillips screwdriver.</li> <li>• Wash with warm, soapy water and a plastic scrubbing pad or soak in vinegar and water solution.</li> <li>• Rinse and dry well.</li> <li>• If ports are clogged, clean with a straight pin. <b>Do not enlarge or distort ports. Do not use a wooden toothpick.</b></li> <li>• Do not clean surface burner in dishwasher.</li> </ul>
<b>Broiler drawer, pan and grid</b> (clean after each use)	Steel-wool pad and warm, soapy water	<ul style="list-style-type: none"> <li>• Clean after each use.</li> <li>• Wash, rinse and dry thoroughly.</li> <li>• <b>After broiler is cool</b>, wipe interior with warm, damp sponge. For heavily soiled areas, use a soapy steel-wool pad.</li> </ul>
<b>Oven racks</b>	Steel-wool pad and warm, soapy water	<ul style="list-style-type: none"> <li>• Wash, rinse and dry thoroughly.</li> </ul>
<b>Oven door glass</b> (Models FGP325Y, FGP320Y, FGP320A and FLP320A)	<p>Paper towel and spray glass cleaner <b>OR</b> Warm, soapy water and a nonabrasive, plastic scrubbing pad</p>	<ul style="list-style-type: none"> <li>• Make sure oven is cool.</li> <li>• Follow directions provided with the cleaner.</li> <li>• Wash, rinse and dry thoroughly.</li> </ul>

continued on next page

## CARING FOR YOUR RANGE

PART	WHAT TO USE	HOW TO CLEAN
<p><b>Oven cavity</b></p>	<p>Sponge and warm, soapy water</p> <p>Soapy steel-wool pad for heavily soiled areas</p> <p><b>OR</b></p> <p>Commercial oven cleaner for heavily soiled areas</p>	<ul style="list-style-type: none"> <li>• Make sure oven is cool.</li> <li>• Remove door and oven bottom for easier access. (See pages 20 and 21.)</li> <li>• Wash, rinse and dry well.</li> </ul> <ul style="list-style-type: none"> <li>• Remove door for easier access.</li> <li>• Rinse well with water.</li> </ul> <ul style="list-style-type: none"> <li>• Remove door and oven bottom for easier access.</li> <li>• Place newspaper on floor to protect floor surface.</li> <li>• Follow directions provided with the oven cleaner.</li> <li>• Rinse well with clear water.</li> <li>• Use in well-ventilated room.</li> <li>• <b>Do not allow commercial oven cleaners to contact the heat seal, thermostat or exterior surfaces of the range. Damage will occur.</b></li> </ul>



# If You Need Assistance Or Service

This section is designed to help you save the cost of a service call. Part 1 of this section outlines possible problems, their causes, and actions you can take to solve each problem. Parts 2 and 3 tell you what to do if you still need assistance or service. When calling our toll-free telephone number for help or calling for service, please provide a detailed description of the problem, your appliance's complete model and serial numbers and the purchase date. (See page 2.) This information will help us respond properly to your request.

## 1. Before calling for assistance ...

Performance problems often result from little things you can find and fix without tools of any kind. Please check the chart below for problems you can fix. It could save you the cost of a service call.

PROBLEM	POSSIBLE CAUSE	SOLUTION
<b>Nothing will operate</b>	<p>The power cord is not plugged into a live circuit with proper voltage.</p> <p>Range is not properly connected to gas supply.</p> <p>A household fuse has blown or a circuit breaker has tripped.</p> <p>Controls are not set correctly.</p> <p>The flow of combustion and/or ventilation air to the range is blocked.</p>	<p>Plug the power cord into a live circuit with proper voltage. (See Installation Instructions.)</p> <p>Contact an authorized Roper service technician to reconnect range to gas supply. (See Installation Instructions.)</p> <p>Replace household fuse or reset circuit breaker.</p> <p>Reset controls, if needed.</p> <p>Remove blockage to airflow to and around range.</p>
<b>The oven will not operate</b>	<p>The Oven Temperature Control is not turned to a temperature setting.</p> <p>Pilot is extinguished on standing pilot models.</p>	<p>Push in and turn the Oven Temperature Control to a temperature setting.</p> <p>Light pilot. (See "Lighting standing pilots" on page 11.)</p>
<b>Burner fails to light</b>	<p>The power cord is not plugged into a live circuit with proper voltage.</p> <p>A household fuse has blown or a circuit breaker has tripped.</p> <p>Burner ports are clogged.</p> <p>Pilot is extinguished on standing pilot models.</p>	<p>Plug the power cord into a live circuit with proper voltage. (See Installation Instructions.)</p> <p>Replace household fuse or reset circuit breaker. In case of prolonged power failure, manually light burners (see page 8).</p> <p>Clean with a straight pin (see pages 19 and 23).</p> <p>Light pilot. (See "Lighting standing pilots" on page 11.)</p>

**continued on next page**

## IF YOU NEED ASSISTANCE OR SERVICE

PROBLEM	POSSIBLE CAUSE	SOLUTION
<b>Burner flames are uneven</b>	Burner ports are clogged.	Clean with a straight pin (see pages 19 and 23). If this fails, call an authorized Roper service technician for service.
<b>Burner flames lift off ports, are yellow, or are noisy when turned off</b>	Air/gas mixture is incorrect.	Contact an authorized Roper service technician to check air/gas mixture.
<b>Burner makes popping noise when on</b>	Burner is wet from washing.	Let dry.
<b>Control knob(s) will not turn</b>	You are not pushing in before turning.	Push control knob(s) in before turning to a setting.
<b>Cooking results are not what you expected</b>	<p>The range is not level.</p> <p>The oven temperature seems too low or too high.</p> <p>The oven was not preheated as the recipe calls for.</p> <p>The recipe has never been tested or is not from a reliable source.</p> <p>The pans are not the type or size recommended in the recipe.</p> <p>There is not proper air circulation around pan when baking.</p> <p>Flame size does not fit the cooking utensil being used.</p> <p>When broiling, you have not completely closed the broiler drawer.</p>	<p>Level range. (See Installation Instructions.)</p> <p>Adjust the oven temperature control. (See "Adjusting the oven temperature control" on page 13.)</p> <p>Preheat oven if called for in recipe.</p> <p>Use only tested recipes from a reliable source.</p> <p>Refer to a reliable cookbook for recommended pan type and size.</p> <p>Allow 1½ to 2 inches (4-5 cm) on all sides of the pans for air circulation. There must be a minimum space of 1 inch (2.5 cm).</p> <p>Adjust flame size to fit cooking utensil.</p> <p>Completely close broiler drawer.</p>

**2. If you need assistance ...**

Call our toll-free telephone number. Dial toll-free from anywhere in the U.S.A.:

**1-800-44-ROPER  
(1-800-447-6737)**

and talk with one of our trained consultants. The consultant can instruct you in how to obtain satisfactory operation from your appliance or, if service is necessary, recommend a qualified service company in your area.

For further information, write to:

Mr. William Clark  
Consumer Assistance Representative  
Roper Brand Appliances  
2000 North M-63  
Benton Harbor, MI 49022-2692

Please include a daytime phone number in your correspondence.

**3. If you need service ...**

Contact the dealer from whom you purchased the appliance or the authorized servicer in your area. For help finding an authorized servicer in your area, call our toll-free telephone number in Step 2.

**4. If you need FSP® replacement parts ...**

FSP is a registered trademark of Whirlpool Corporation for quality parts. Look for this symbol of quality whenever you need a replacement part for your Roper® appliance. FSP replacement parts will fit right and work right, because they are made to the same exacting specifications used to build every new Roper appliance.

To locate FSP replacement parts in your area, refer to Step 3 above or call our toll-free telephone number in Step 2.

**5. If you are not satisfied with how the problem was solved ...**

- Contact the Major Appliance Consumer Action Panel (MACAP). MACAP is a group of independent consumer experts that voices consumer views at the highest levels of the major appliance industry.
- Contact MACAP only when the dealer, authorized servicer and Roper Brand Appliance warrantor have failed to resolve your problem.

Major Appliance Consumer Action Panel  
20 North Wacker Drive  
Chicago, IL 60606

- MACAP will in turn inform us of your action.

# ROPER® Gas Range Warranty

LENGTH OF WARRANTY	WE WILL PAY FOR
<b>FULL ONE-YEAR WARRANTY</b> (from date of purchase)	FSP® replacement parts and repair labor to correct defects in materials or workmanship. Service must be provided by an authorized Roper service company.
<b>WE WILL NOT PAY FOR</b>	
<p><b>A.</b> Service calls to:</p> <ol style="list-style-type: none"> <li>1. Correct the installation of your range.</li> <li>2. Instruct you how to use your range.</li> <li>3. Replace house fuses or correct house wiring or plumbing.</li> <li>4. Replace owner accessible light bulbs.</li> </ol> <p><b>B.</b> Repairs when your range is used in other than normal, single-family household use.</p> <p><b>C.</b> Pickup and delivery. Your range is designed to be repaired in the home.</p> <p><b>D.</b> Damage to your range caused by accident, misuse, fire, flood, acts of God, or use of products not approved by us.</p> <p><b>E.</b> Repairs to parts or systems caused by unauthorized modifications made to the appliance.</p>	

5/93

This Roper appliance is warranted by Whirlpool Corporation. Under no circumstances shall it be liable under this warranty for incidental or consequential damages. Some states do not allow the exclusion or limitation of incidental or consequential damages, or limitation of implied warranties, so these limitations or exclusions may not apply to you.

This warranty gives you specific legal rights, and you may also have other rights which vary from state to state.

Outside the United States, a different warranty may apply. For details, please contact your authorized Roper distributor or military exchange.

If you need service, first see the "If You Need Assistance Or Service" section of this book. After checking "If You Need Assistance Or Service," additional help can be found by calling our toll-free telephone number, **1-800-44-ROPER (1-800-447-6737)**, from anywhere in the U.S.A.



Printed on recycled paper—  
10% post-consumer waste  
50% recovered materials

**PART NO. 316000736/4372208 Rev. A**

© 1994 Whirlpool Corporation

® Registered Trademark of Whirlpool, U.S.A.

Printed in U.S.A.

## Free Manuals Download Website

<http://myh66.com>

<http://usermanuals.us>

<http://www.somanuals.com>

<http://www.4manuals.cc>

<http://www.manual-lib.com>

<http://www.404manual.com>

<http://www.luxmanual.com>

<http://aubethermostatmanual.com>

Golf course search by state

<http://golfingnear.com>

Email search by domain

<http://emailbydomain.com>

Auto manuals search

<http://auto.somanuals.com>

TV manuals search

<http://tv.somanuals.com>