

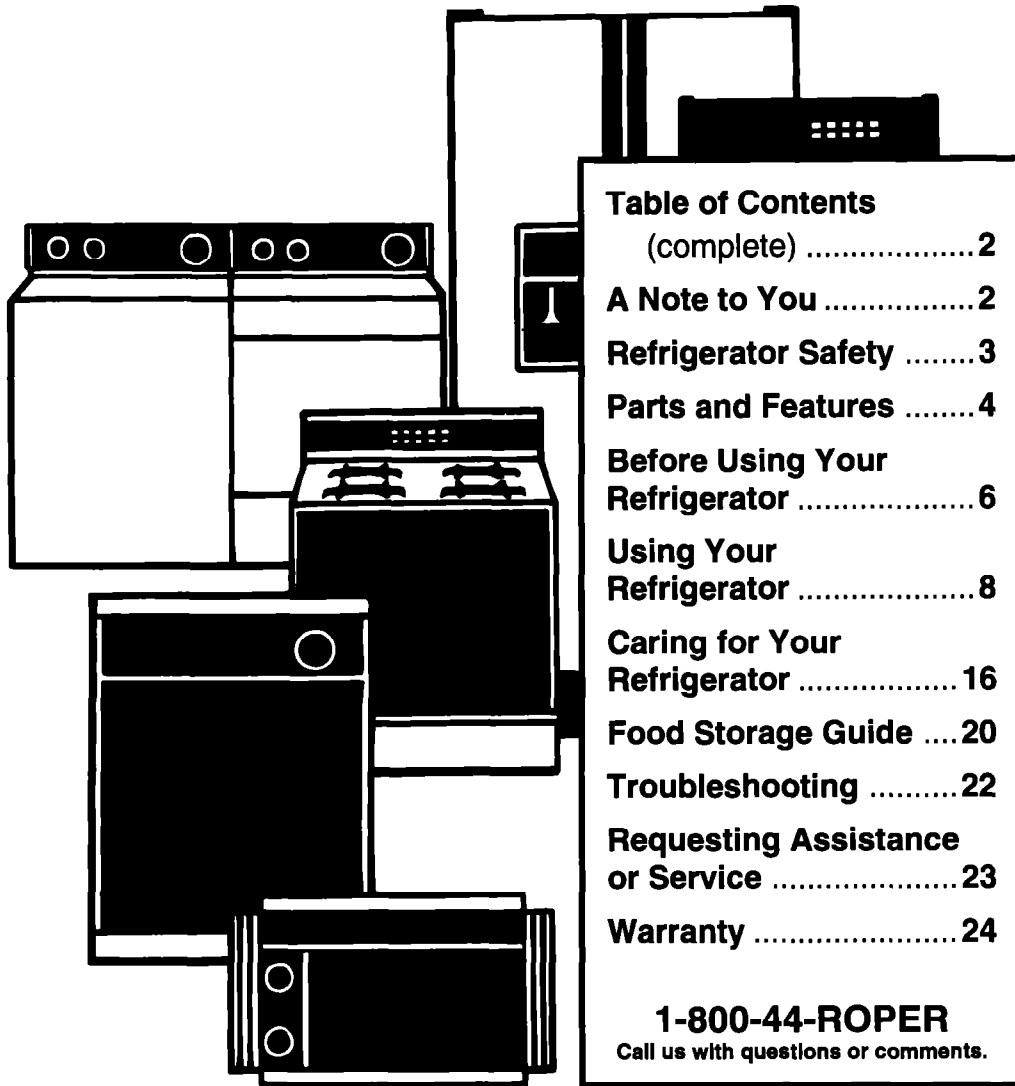

Use And Care

GUIDE



4/95

14' NO-FROST TOP FREEZER REFRIGERATOR

PART NO. 2183013

Table of Contents

| | | | |
|--|----|--|----|
| A Note to You | 2 | Changing the light bulb | 14 |
| Refrigerator Safety | 3 | Understanding the sounds you may hear | 15 |
| Parts and Features | 4 | Saving energy | 15 |
| Before Using Your Refrigerator | 6 | Reversing the door swing | 15 |
| Cleaning your refrigerator | 6 | Caring for Your Refrigerator | 16 |
| Plugging it in | 6 | Cleaning your refrigerator | 16 |
| Installing it properly | 7 | Vacation and moving care | 18 |
| Leveling it | 7 | Power interruptions | 19 |
| Using Your Refrigerator | 8 | Food Storage Guide | 20 |
| Setting the temperature control | 8 | Storing fresh food | 20 |
| Adjusting the refrigerator shelves | 9 | Storing frozen food | 21 |
| Removing the crispers and cover | 9 | Troubleshooting | 22 |
| Using the ice cube trays | 10 | Requesting Assistance or Service | 23 |
| Using the automatic ice maker | 10 | Warranty | 24 |
| Attaching the ice maker to a water supply | 11 | | |

A Note to You

Thank you for buying a ROPER® appliance.

ROPER appliances give you all the functionality of name brand appliances at a value price. To ensure you enjoy years of trouble-free operation, we developed this Use and Care Guide. It contains valuable information about how to operate and maintain your appliance properly and safely. Please read it carefully. Also, please complete and mail the Ownership Registration Card provided with your appliance. This card helps us notify you about any new information on your appliance.

Please record your model's information.

Whenever you call to request service on your appliance, you need to know your complete model number and serial number. You can find this information on the model and serial number label (see diagrams on page 4 or 5 for location of label).

Please also record the purchase date of your appliance and your dealer's name, address, and telephone number.

Model Number _____

Serial Number _____

Purchase Date _____

Dealer Name _____

Dealer Address _____

Dealer Phone _____

Keep this book and the sales slip together in a safe place for future reference.

Refrigerator Safety

Your safety is important to us.

This guide contains statements under warning symbols. Please pay special attention to these symbols and follow any instructions given. Here is a brief explanation of the use of the symbol.

WARNING

This symbol alerts you to such dangers as fire, electrical shock, burns, and personal injury.

IMPORTANT SAFETY INSTRUCTIONS

WARNING

To reduce the risk of fire, electrical shock, or injury when using your refrigerator, follow these basic precautions:

- Read all instructions before using the refrigerator.
- Child entrapment and suffocation are not problems of the past. Junked or abandoned refrigerators are still dangerous ... even if they will "just sit in the garage a few days."
If you are getting rid of your old refrigerator, do it safely. Please read the enclosed safety booklet from the Association of Home Appliance Manufacturers. Help prevent accidents.
- Never allow children to operate, play with, or crawl inside the refrigerator.
- Never clean refrigerator parts with flammable fluids. The fumes can create a fire hazard or explosion.

• FOR YOUR SAFETY •

DO NOT STORE OR USE GASOLINE OR OTHER FLAMMABLE VAPORS AND LIQUIDS IN THE VICINITY OF THIS OR ANY OTHER APPLIANCE. THE FUMES CAN CREATE A FIRE HAZARD OR EXPLOSION.

– SAVE THESE INSTRUCTIONS –

Help us help you

Please:

- Install and level the refrigerator on a floor that will hold the weight and in an area suitable for its size and use.
- Do not install the refrigerator near an oven, radiator, or other heat source.
- Do not use the refrigerator in an area where the room temperature will fall below 55°F (13°C).
- Keep the refrigerator out of the weather.
- Connect the refrigerator only to the proper kind of outlet, with the correct electrical supply and grounding. (Refer to the Electrical Requirements and Grounding Instructions Sheet.)
- Do not load the refrigerator with food before it has time to get properly cold.
- Use the refrigerator only for the uses described in this manual.
- Properly maintain the refrigerator.
- Be sure the refrigerator is not used by anyone unable to operate it properly.

Parts and Features

This section contains captioned illustrations of your appliance. Use them to become familiar with where all parts and features are located and what they look like.

NOTE: The model you have purchased may have all or some of the parts and features shown and may not match the illustration exactly. This manual is designed to cover several models.

Control panel (all models)

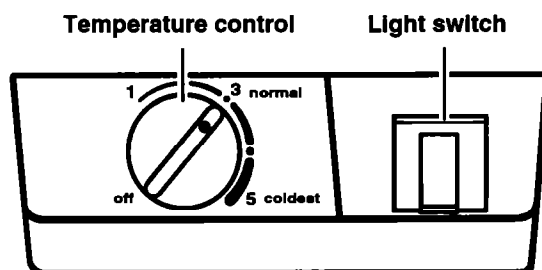

Style 1

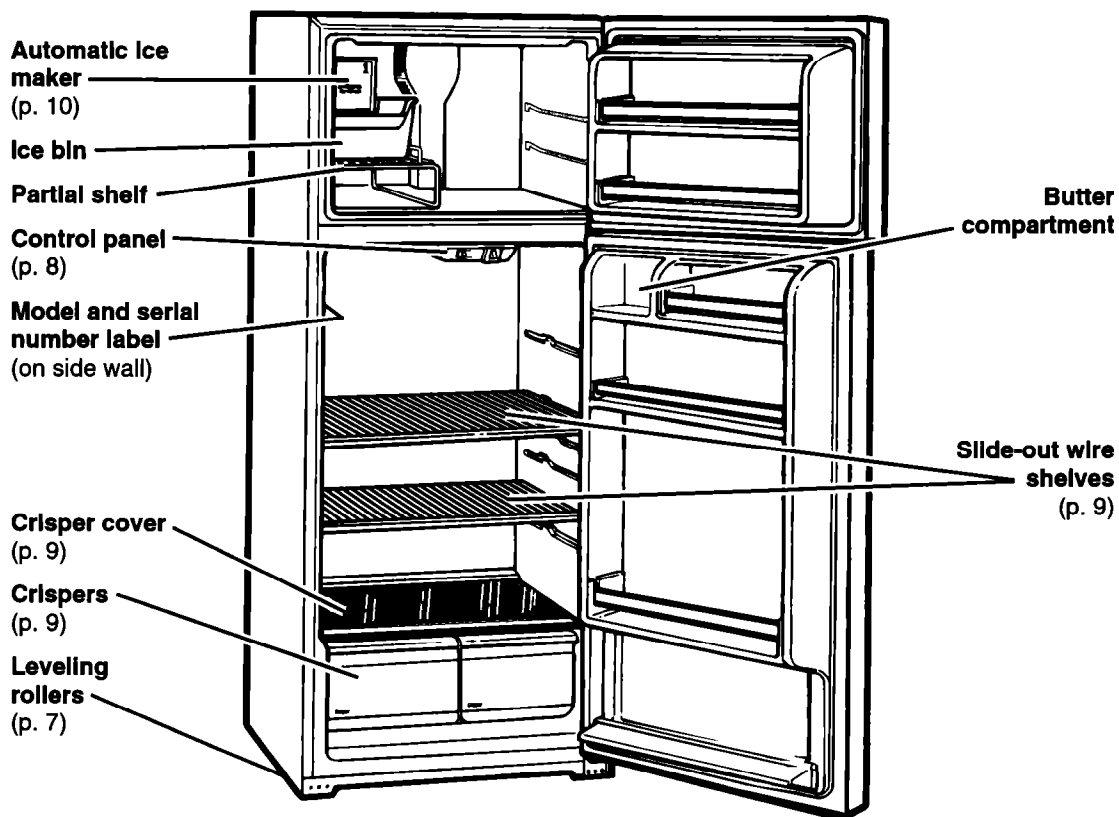

PARTS AND FEATURES

Style 2

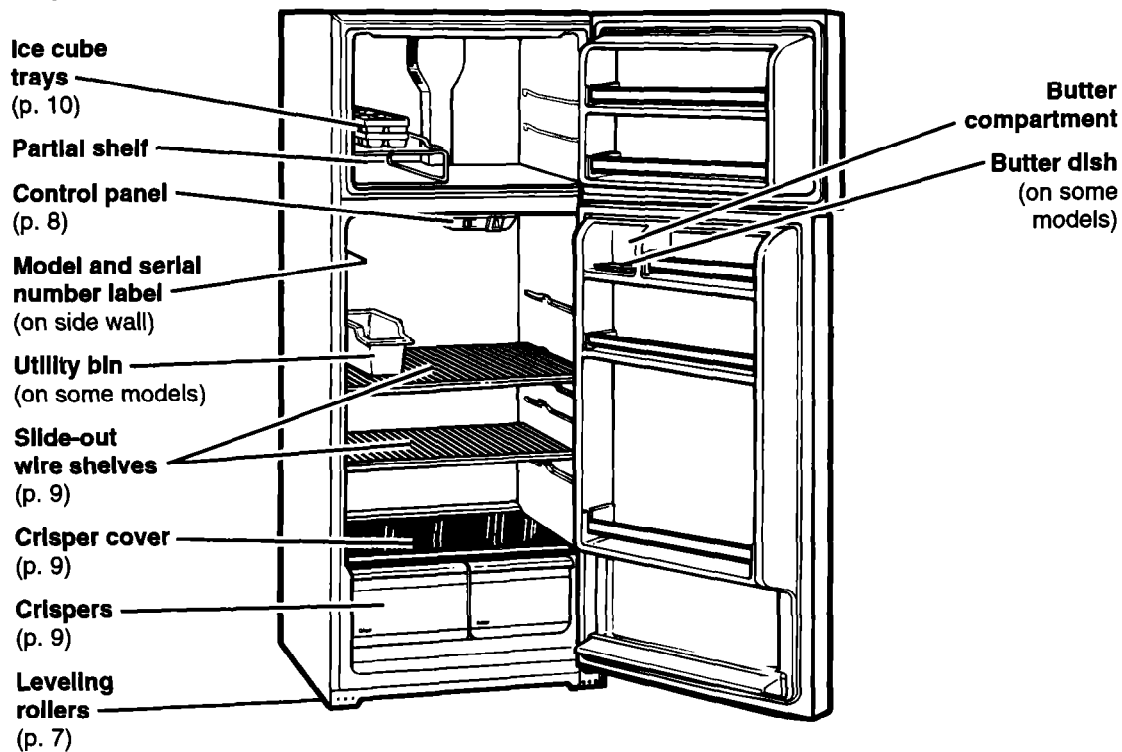

Style 3

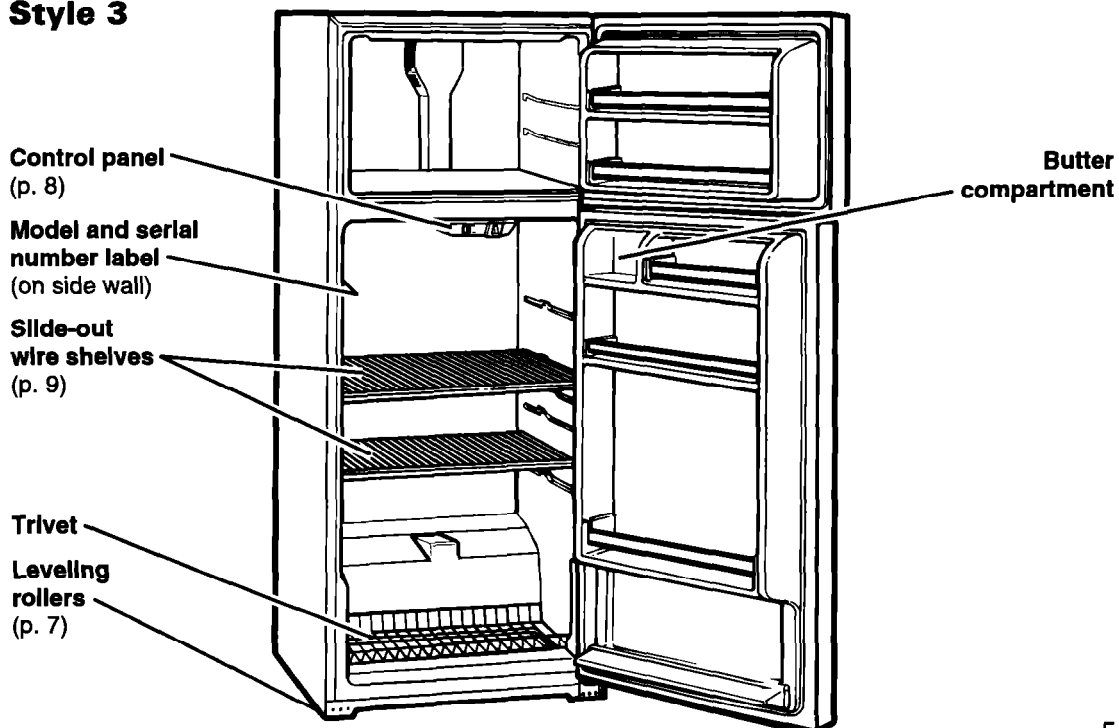

Before Using Your Refrigerator

It is important to prepare your refrigerator for use. This section tells you how to clean it, connect it to a power source, install it, and level it.

Cleaning your refrigerator

Removing packaging materials

Remove tape and any inside labels (except the model and serial number label) before using the refrigerator.

To remove any remaining glue:

- Rub briskly with your thumb to make a ball, then remove.

OR

- Soak area with liquid hand-dishwashing detergent before removing glue as described above. Do not use sharp instruments, rubbing alcohol, flammable fluids, or abrasive cleaners. These can damage the material. See "Important Safety Instructions" on page 3.

NOTE: Do not remove any permanent instruction labels inside your refrigerator. Do not remove the Tech Sheet fastened under the refrigerator at the front.

Cleaning it before use

After removing all packaging materials, clean your refrigerator before using it, if necessary. See cleaning instructions on pages 16 and 17.



Plugging it in

Recommended Grounding Method

A 115 Volt, 60 Hz., AC only 15 or 20 ampere fused and properly grounded electrical supply is required. It is recommended that a separate circuit serving only this appliance be provided. Use a receptacle which cannot be turned off with a switch or pull chain. Do not use an extension cord.

See Electrical Requirements and Grounding Instructions Sheet in your Literature Package.

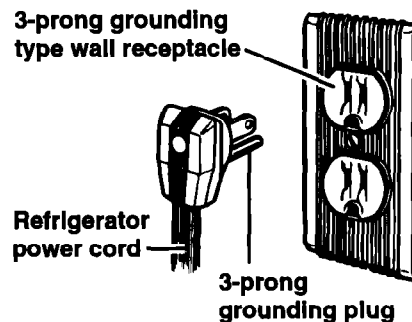

BEFORE USING YOUR REFRIGERATOR

Installing it properly

1. Allow 3 inches (7.5 cm) between overhead cabinets and refrigerator top.
2. Allow at least 1 inch (2.5 cm) between the refrigerator condenser on the back and the wall.
3. Allow ½ inch (1.25 cm) on each side of the refrigerator for ease of installation.
4. If the hinge side of the refrigerator is to be against a wall, you might want to leave extra space so the door can be opened wider.
5. Level your refrigerator.

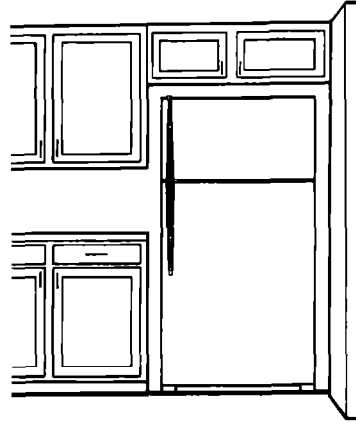

Leveling it

Your refrigerator has two front, adjustable rollers to prevent rocking on uneven floors.

To adjust rollers:

1. Roll refrigerator into position.
2. Adjust rollers by turning the leveling screws, located at the front of the base.
 - Turn clockwise to raise.
 - Turn counterclockwise to lower.

NOTE: Rollers are adjusted correctly when the refrigerator no longer rocks when the doors are opened or closed.
3. Repeat this procedure whenever the refrigerator is moved.

NOTE: If you want the doors to close easier, use the rollers to raise the front of the refrigerator slightly.

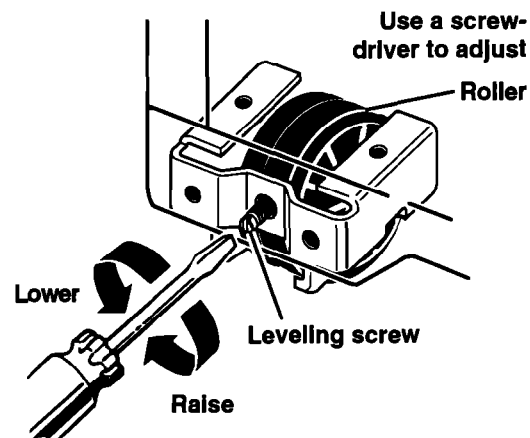

View of roller with hinge in place

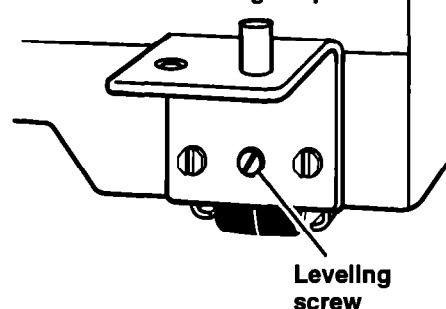

Using Your Refrigerator

To obtain the best possible results from your refrigerator, it is important that you operate it properly. This section tells you how to set the temperature control, remove and adjust some of the features in your refrigerator, and how to save energy.

Setting the temperature control

The Temperature Control is in the refrigerator. It controls the temperature in both the refrigerator and freezer compartments.

When you plug in the refrigerator for the first time:

1. Set the Temperature Control to 3 (normal). Temperature Control adjustments range from 1 (warmest) to 5 (coldest).

NOTE: Turning the Temperature Control to OFF stops cooling in both the refrigerator and freezer compartments, but it does not disconnect the refrigerator from the power supply.

2. Give the refrigerator time to cool down completely before adding food. This could take several hours.
3. Adjust the Temperature Control to have food as cold as you like. The setting indicated above should be correct for normal, household refrigerator usage.

NOTE: The built-in exterior moisture control continuously guards against moisture build-up on the outside of the refrigerator cabinet.

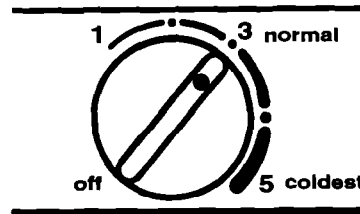

Adjusting the refrigerator shelves

The refrigerator shelves can be adjusted to match the way you use your refrigerator.

To remove the shelves:

1. Remove items from the shelf.
2. Slide shelf straight out to the stop.
3. Lift back of shelf over stop.
4. Slide shelf out the rest of the way.

To replace the shelves:

1. Slide back of shelf into shelf track in wall of cabinet.
2. Guide front of shelf into shelf track.
3. Slide shelf in all the way.

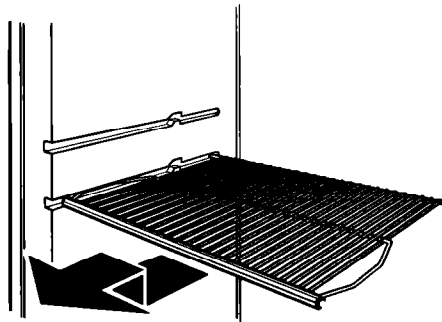

Removing the crispers and cover

To remove the crispers:

1. Slide crispers straight out to the stop.
2. Lift the front.
3. Slide out the rest of the way.
4. Replace in reverse order.

To remove the cover:

1. Lift cover front and remove the cover support.
2. Lift cover up and slide out.

To replace the cover:

1. Fit cover tabs into lowest cabinet slots and push in. Lower the front retainers into place.
2. Insert cover support (with the long tab toward the front) into the groove on the underside of the cover.

NOTE: If the support needs adjustment, turn base clockwise to raise or counter-clockwise to lower.

Lift cover front, then the back.

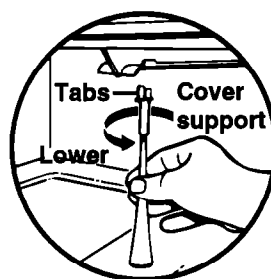
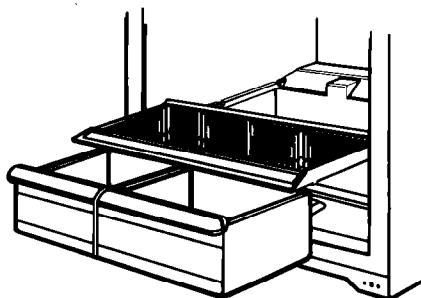

USING YOUR REFRIGERATOR

Using the ice cube trays

(on some models)

If you don't use the cubes, they may shrink. The moving cold air starts a slow evaporation. The longer you store cubes, the smaller they get.

To remove ice:

1. Hold tray at both ends.
2. Twist slightly.

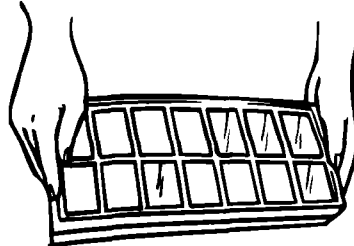

Using the automatic ice maker

(on some models)

If you have an automatic ice maker, or if you plan to add one later, there are a few things you will want to know:

- The ON/OFF lever is a wire signal arm.
DOWN to make ice automatically
UP to shut off the ice maker

IMPORTANT: Do not turn ice maker on until it is connected to the water supply. **Instructions for ice maker water supply hookup are attached to the back of the refrigerator cabinet.**

- The dial or lever on the side of the ice maker changes the size of the cubes.
- Good water quality is important for good ice quality. Try to avoid connecting the ice maker to a softened water supply. Water softener chemicals, such as salt from a malfunctioning softener, can damage the ice maker mold and lead to poor ice quality. If a softened water supply cannot be avoided, make sure that the water softener is well maintained and operating properly.

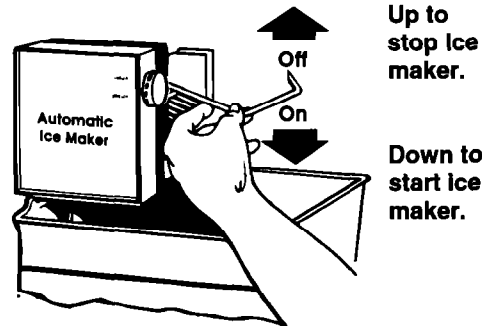

Solving common ice maker problems

| PROBLEM | POSSIBLE CAUSE/SOLUTION |
|--|--|
| Ice crescents attached at corners | <ul style="list-style-type: none"> • This is normal. They break apart easily. Shake bin occasionally to keep cubes separated. |
| Ice maker will not operate or ice is not made fast enough | <ul style="list-style-type: none"> • ON/OFF lever is in the OFF (up) position. Lower lever to the ON (down) position. • Freezer is not cold enough. Adjust temperature control and wait 24 hours. |
| Off-taste or odor in ice | <ul style="list-style-type: none"> • New plumbing connections can cause discolored or off-flavored ice. Discard the first few batches of ice. • Cubes are stored too long. Throw them away and make a new supply. • Foods in freezer are not wrapped properly. See "Food Storage Guide" on pages 20 and 21. • Freezer and ice bin need to be cleaned. See page 16. |

Attaching the ice maker to a water supply

Read all directions carefully before you begin.

⚠ WARNING

Electrical Shock Hazard

Disconnect electrical supply to refrigerator before installing.

Electrical drill must be grounded before drilling holes in water line.

Failure to do so could result in death, electrical shock, or serious injury.

IMPORTANT:

- Use copper tubing only and check for leaks.
- Install ice maker tubing in areas where temperatures are above freezing.

Tools required:

- Standard screwdriver
- 7/16-inch and 1/2-inch open-end wrenches or 2 adjustable wrenches
- 1/4-inch nut driver
- 1/4-inch drill bit
- Hand drill or electric drill (properly grounded)

NOTE: Your appliance dealer has a kit available with a 1/4-inch saddle type shut-off valve, a union, and copper tubing.

Before purchasing, make sure a saddle type valve complies with your local plumbing codes. Do not use piercing type or 3/16-inch saddle valve which reduces water flow and clogs more easily.

Cold water supply

Ice maker water valve contains a flow washer which is used as a water pressure regulator. The ice maker needs to be connected to a cold water line with water pressure limitations of 20-120 PSI. If a problem occurs, call your utility company.

IMPORTANT:

- It may take up to 24 hours for your ice maker to begin producing ice.
- If operating the refrigerator before installing the water connection, turn ice maker to the OFF position to prevent operation without water.
- All installations must be in accordance with local plumbing code requirements.

**INSTALLATION IS NOT WARRANTED
BY REFRIGERATOR OR ICE MAKER
MANUFACTURER.**

USING YOUR REFRIGERATOR

Connecting to water line

1. Find a ½-inch to 1¼-inch vertical COLD water pipe near the refrigerator.
NOTE: Horizontal pipe will work, but the following precaution must be taken: Drill on the top side of the pipe, not the bottom. This will help keep water away from the drill. This also keeps normal sediment from collecting in the valve.
2. Measure from connection on rear of refrigerator to water pipe. Add 7 feet (2.1 m) to allow for moving refrigerator for cleaning. This is the length of ¼-inch O.D. copper tubing you will need for the job (length from connection to water pipe PLUS 7 feet [2.1m]). Be sure both ends of copper tubing are cut square.
3. Turn OFF main water supply. Turn ON nearest faucet long enough to clear line of water.
4. Using a grounded drill, drill a ¼-inch hole on the cold water pipe you have selected.
5. Fasten shut-off valve to cold water pipe with pipe clamp. Be sure outlet end is solidly in the ¼-inch drilled hole in the water pipe and that washer is under the pipe clamp. Tighten packing nut. Tighten the pipe clamp screws carefully and evenly so washer makes a watertight seal. Do not overtighten or you may crush the copper tubing, especially if soft (coiled) copper tubing is used. Now you are ready to connect the copper tubing.
6. Slip compression sleeve and compression nut on copper tubing as shown in diagram. Insert end of tubing into outlet end squarely as far as it will go. Screw compression nut onto outlet end with adjustable wrench. Do not over tighten. Turn ON main water supply and flush out tubing until water is clear. Turn OFF shut-off valve on the water pipe. Coil copper tubing.

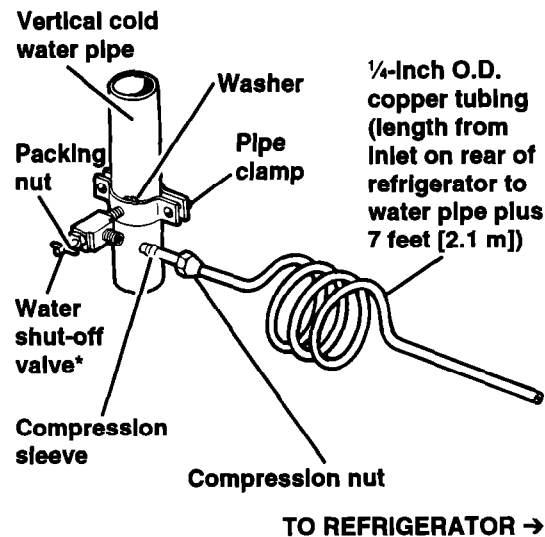

*Controls water supply

USING YOUR REFRIGERATOR

Connecting to refrigerator

1. (On kit models, assemble water valve to refrigerator per kit instructions.) Route the copper tubing through the tube clamp provided as shown at right. Connect the $\frac{1}{4}$ -inch copper tube from the shut-off valve to the water valve at the lower, left rear of cabinet. Remove tape label from valve inlet and insert tubing until it bottoms out. (Approximately $\frac{1}{2}$ inch.) Tighten nut by hand as much as possible; then turn the nut an additional $\frac{1}{2}$ turn using a wrench. Do not over tighten.
2. Turn shut-off valve ON. CHECK FOR LEAKS. TIGHTEN ANY CONNECTIONS (INCLUDING CONNECTIONS AT THE VALVE) OR NUTS THAT LEAK.
3. The ice maker is equipped with a built-in water strainer. If local water conditions require periodic cleaning or a well is your source of water supply, a second water strainer should be installed in the $\frac{1}{4}$ -inch water line. Obtain a water strainer from your nearest appliance dealer. Install at either tube connection.
4. Reconnect electrical supply to refrigerator.

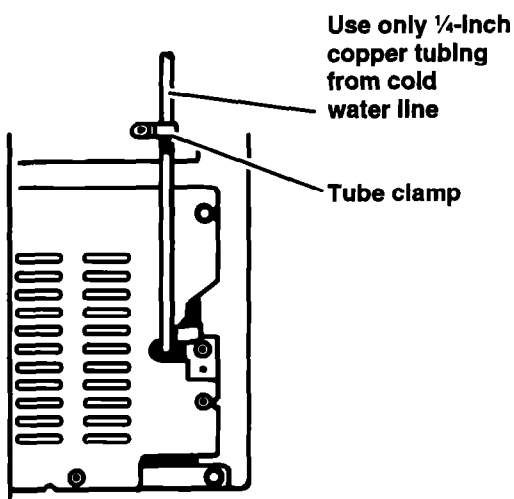

Changing the light bulb

⚠ WARNING

Electrical Shock Hazard

Before removing a light bulb, either unplug the refrigerator or disconnect the electricity leading to the refrigerator at the main power supply. Turning the Temperature Control to the OFF position does not disconnect the refrigerator from the power supply.

Failure to do so could result in electrical shock or personal injury.

To change the refrigerator light:

1. Disconnect refrigerator from power supply.
2. Reach behind the Control Panel to remove bulb.
3. Replace with a 40-watt appliance bulb.
4. Reconnect refrigerator to power supply.

NOTE: Not all commercial appliance bulbs will fit your refrigerator. Be sure to replace a bulb with one of the same size, wattage, and shape.

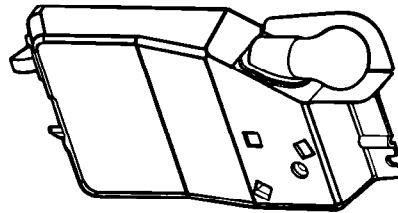

Understanding the sounds you may hear

Your new refrigerator may make sounds that your old one didn't. Because the sounds are new to you, you might be concerned about them. Don't be. Most of the new sounds are normal. Hard surfaces like the floor, walls, and cabinets can make the sounds seem louder.

The following describes the kinds of sounds that might be new to you, and what may be making them.

Slight hum, soft hiss

You may hear the refrigerator's fan motor and moving air.

Clicking or snapping sounds

The thermostat makes a definite click when the refrigerator stops running. It also makes a sound when the refrigerator starts. The defrost timer will click when the defrost cycle starts.

Water sounds

When the refrigerator stops running, you may hear gurgling in the tubing for a few minutes after it stops. You may also hear defrost water running into the defrost water pan.

Ice maker sounds

- trickling water
- thud (clatter of ice)

If your refrigerator has an ice maker, you may hear buzzing (from the water valve), trickling water, and the clatter of ice dumped into the bin.

Saving energy

You can help your refrigerator use less electricity.

- Check door gaskets for a tight seal. Level the cabinet to be sure of a good seal.
- Clean the condenser coils regularly.
- Open the door as few times as possible. Think about what you need before you open the door. Get everything out at one time. Keep food organized so you won't have to search for what you want. Close door as soon as food is removed.

- Go ahead and fill up the refrigerator, but don't overcrowd it so air movement is blocked.
- It is a waste of electricity to set the refrigerator and freezer to temperatures colder than they need to be. If ice cream is firm in the freezer and drinks are as cold as your family likes them, that's cold enough.
- Make sure your refrigerator is not next to a heat source such as a range, water heater, furnace, radiator, or in direct sunlight.

Reversing the door swing

(on some models)

You can change the hinges on your refrigerator so the doors open the other way. Refer to the instruction sheet included with your refrigerator.

Caring for Your Refrigerator

Your refrigerator is built to give you many years of dependable service. However, there are a few things you can do to extend its product life. This section tells you how to clean your refrigerator and what to do when going on vacation, moving, or during a power outage.

Cleaning your refrigerator

Both the refrigerator and freezer sections defrost automatically. However, clean both about once a month to help prevent odors from building up. Wipe up spills right away.



To clean your refrigerator, turn the Refrigerator Control to OFF, unplug it, take out all removable parts, and clean the refrigerator according to the following directions.

⚠ WARNING

Personal Injury Hazard

Refrigeration system tubes are located near the defrost pan and can become hot. Remove and install defrost pan carefully.

Failure to do so could result in personal injury.

| PART | WHAT TO USE | HOW TO CLEAN |
|--|--|---|
| Removable parts (shelves, crisper, etc.) | Sponge or cloth with mild detergent and warm water | <ul style="list-style-type: none"> • Hand wash, rinse, and dry thoroughly. |
| Outside | Sponge, cloth, or paper towel with mild detergent, warm water, and an appliance wax (or good auto paste wax) | <ul style="list-style-type: none"> • Wash outside of cabinet. Do not use abrasive or harsh cleaners. • Wipe and dry thoroughly. • Wax painted metal surfaces at least twice a year. Apply wax with a clean, soft cloth. Waxing painted metal surfaces provides rust protection. Do not wax plastic parts. |
| Inside walls (allow freezer to warm up so cloth won't stick) | Sponge, soft cloth, or paper towel with baking soda or mild detergent and warm water | <ul style="list-style-type: none"> • Wash with mixture of warm water and <ul style="list-style-type: none"> – mild detergent, or – baking soda (2 tablespoons [26 g] to 1 quart [.95 L] of water). • Wipe and dry thoroughly. |

CARING FOR YOUR REFRIGERATOR

| PART | WHAT TO USE | HOW TO CLEAN |
|--|--|---|
| Door liners and gaskets | Sponge, soft cloth, or paper towel with mild detergent and warm water | <ul style="list-style-type: none"> • Wash, wipe, and dry thoroughly. <p>DO NOT USE cleaning waxes, concentrated detergents, bleaches, or cleaners containing petroleum on plastic parts.</p> |
| Plastic parts (covers and panels) | Soft, clean sponge or soft, clean cloth with mild detergent and warm water | <ul style="list-style-type: none"> • Wash, wipe, and dry thoroughly. <p>DO NOT USE paper towels, window sprays, scouring cleansers, or flammable fluids. These can scratch or damage material. See "Important Safety Instructions" on page 3.</p> |
| Condenser coils | Vacuum cleaner with extended narrow attachment | <ul style="list-style-type: none"> • Roll refrigerator out away from the wall. • Vacuum coils when dusty or dirty. Coils may need cleaning as often as every other month. • Roll refrigerator back into place. Make sure to leave 1 inch (2.5 cm) between the cabinet back and the wall. • Check to see if the refrigerator is level. |

Vacation and moving care

Short vacations

No need to shut off the refrigerator if you will be away for less than four weeks.

1. Use up any perishables.
2. Freeze other items.
3. If your refrigerator has an automatic ice maker:
 - Raise signal arm to OFF (up) position.
 - Shut off water supply to ice maker.
 - Empty the ice bin.

Long vacations

If you will be gone a month or more:

1. Remove all food from the refrigerator.
2. If your refrigerator has an automatic ice maker:
 - Turn off the water supply to the ice maker at least one day ahead of time.
 - When the last load of ice drops, turn off the ice maker. Make sure all ice is dispensed out of the ice maker mechanism.
3. Unplug the refrigerator.
4. Clean it, wipe well, and dry.
5. Tape rubber or wood blocks to the tops of both doors to prop them open far enough for air to get in. This stops odor and mold from building up.

Moving

When you are moving the refrigerator to a new home:

1. If your refrigerator has an automatic ice maker:
 - Turn off the water supply to the ice maker at least one day ahead of time.
 - Disconnect the water line.
 - After the last load of ice drops, lift the signal arm to the OFF (up) position.
2. Remove all food from the refrigerator.
3. Pack all frozen food in dry ice.
4. Unplug the refrigerator.
5. Clean it thoroughly. Wipe well and dry.
6. Take out all removable parts, wrap them well, and tape them together so they don't shift and rattle.
7. Screw in the leveling rollers.
8. Tape the doors shut and tape the power supply cord to the cabinet.

When you get to your new home, put everything back and refer to page 6. Also, if your refrigerator has an automatic ice maker, remember to reconnect the water supply line.

⚠ WARNING

Personal Injury Hazard

Do not allow children to climb on, play near, or climb inside the refrigerator when the doors are blocked open. They may become injured or trapped.

To restart refrigerator, see "Using Your Refrigerator" on page 8.

Power interruptions

If electricity goes off, call the power company. Ask how long power will be off.

1. If service will be interrupted 24 hours or less, **keep both doors closed**. This helps food stay frozen.
2. If service will be interrupted longer than 24 hours:
 - (a) Remove all frozen food and store in a frozen food locker.

OR

- (b) Place 2 lbs. (907 g) of dry ice in freezer for every cubic foot of freezer space. This will keep food frozen for 2 to 4 days. Wear gloves to protect your hands from dry ice burns.

OR

- (c) If neither a food locker nor dry ice is available, use or can perishable food at once.
3. A full freezer stays cold longer than a partly filled one. A freezer full of meat stays cold longer than a freezer full of baked goods. If food contains ice crystals, it may be safely refrozen, although the quality and flavor may be affected. If the condition of the food is poor, or if you feel it is unsafe, dispose of it.

Food Storage Guide

There is a correct way to package and store refrigerated or frozen food. To keep food fresher, longer, take the time to study these recommended steps.

Storing fresh food

Wrap or store food placed in the refrigerator in airtight and moisture-proof material. This prevents food odor and taste transfer throughout the refrigerator. For dated products, check code date to ensure freshness.

Leafy vegetables

Remove store wrapping and trim or tear off bruised and discolored areas. Wash in cold water and drain. Place in plastic bag or plastic container and store in crisper.

Vegetables with skins

(carrots, peppers)

Store in crisper, plastic bags, or plastic container.

Fruit

Wash, let dry, and store in refrigerator in plastic bags or crisper. Do not wash or hull berries until they are ready to use. Sort and keep berries in their original container in a crisper, or store in a loosely closed paper bag on a refrigerator shelf.

Eggs

Store without washing in the original carton on interior shelf.

Milk

Wipe milk cartons. For best storage, place milk on interior shelf.

Butter or margarine

Keep opened butter in covered dish or closed compartment. When storing an extra supply, wrap in freezer packaging and freeze.

Cheese

Store in the original wrapping until you are ready to use it. Once opened, rewrap tightly in plastic wrap or aluminum foil.

Leftovers

Cover leftovers with plastic wrap or aluminum foil. Plastic containers with tight lids can also be used.

Meat

Store most meat in original wrapping as long as it is airtight and moisture-proof. Rewrap if necessary. See the following chart for storage times.

| TYPE | APPROXIMATE TIME (DAYS)* |
|-------------------|--------------------------|
| Chicken | 1 to 2 |
| Ground beef | 1 to 2 |
| Steaks and roasts | 3 to 5 |
| Cured meats | 7 to 10 |
| Bacon | 5 to 7 |
| Cold cuts | 3 to 5 |
| Variety meats | 1 to 2 |

*If storing meat longer than the times given, follow the directions for freezing.

NOTE: Use fresh fish and shellfish the same day as purchased.

Storing frozen food

The freezer section is designed for storage of commercially frozen food and for freezing food at home.

NOTE: For further information about preparing food for freezing or food storage times, contact your local Cooperative Extension Service or check a freezer guide or reliable cookbook.

Packaging

The secret of successful freezing is in the packaging. The way you close and seal the package must not allow air or moisture in or out. Packaging done in any other way could cause food odor and taste transfer throughout the refrigerator and drying of frozen food.

Packaging recommended for use:

- Rigid plastic containers with tight-fitting lids
- Straight-sided canning/freezing jars
- Heavy-duty aluminum foil
- Plastic-coated paper
- Non-permeable plastic wraps (made from a saran film)

Follow package or container instructions for proper freezing methods.

Do not use:

- Bread wrappers
- Non-polyethylene plastic containers
- Containers without tight lids
- Wax paper
- Wax-coated freezer wrap
- Thin, semi-permeable wrap

The use of these wrappings could cause food odor, taste transfer, and drying of frozen food.

Freezing

Do not expect your freezer to quick-freeze any large quantity of food. Put no more unfrozen food into the freezer than will freeze within 24 hours (no more than 2 to 3 pounds of food per cubic foot of freezer space). Leave enough space for air to circulate around packages. Be careful to leave enough room at the front so the door can close tightly.

Storage times will vary according to the quality of the food, the type of packaging or wrap used (airtight and moisture-proof), and the storage temperature, which should be 0°F (-17.8°C).

Troubleshooting

Listed in the chart below are the most common problems consumers run into with their refrigerator. Please read through this chart before calling for service. It could save you the cost of a service call.

| PROBLEM | CHECK THE FOLLOWING |
|--|---|
| Your refrigerator will not operate | <p>Is the power supply cord firmly plugged into a live circuit with proper voltage?</p> <p>Has a household fuse or circuit breaker blown/tripped?</p> <p>Is the Refrigerator Control set to the OFF position?</p> |
| The lights do not work | <p>Is the power supply cord firmly plugged into a live circuit with proper voltage?</p> <p>Has a household fuse or circuit breaker blown/tripped?</p> <p>Is a bulb burned out?</p> |
| The optional ice maker does not work | <p>Is the freezer cold enough to make ice? It could take overnight for the freezer to reach the proper temperature.</p> <p>Is the ON/OFF lever in the ON (down) position? (See page 10.)</p> <p>Is the water valve turned on?</p> <p>Does the water line have a clog or leak?</p> |
| You hear unfamiliar sounds or a rattling/jingling noise | <p>Is something on top of or behind the refrigerator?</p> <p>Some new sounds are normal. See "Understanding the sounds you may hear" on page 15.</p> |
| There is water in the defrost pan | <p>This is normal on hot, muggy days. Make sure the refrigerator is level so the pan does not overflow.</p> |
| The motor seems to run too much | <p>Are the condenser coils dirty?</p> <p>Has the door been opened often? Has a large amount of food been added at one time? The motor naturally runs longer if these things happen.</p> <p>Is the room hot? If the room is too warm, the motor runs longer to keep the unit cool.</p> |

Requesting Assistance or Service

Before calling for assistance or service, please check "Troubleshooting" on page 22. It may save you the cost of a service call. If you still need help, follow the instructions below.

1. If you need assistance* ...

Call our toll-free telephone number. Dial free from anywhere in the U.S.A.:



1-800-44-ROPER
(1-800-447-6737)

and talk with one of our trained consultants. The consultant can instruct you in how to obtain satisfactory operation from your appliance or, if service is necessary, recommend a qualified service company in your area.

If you prefer, write to:

Mr. William Clark
Consumer Assistance Representative
Whirlpool Corporation
2000 North M-63
Benton Harbor, MI 49022-2692

Please include a daytime phone number in your correspondence.

2. If you need service* ...

Contact the dealer from whom you purchased the appliance or the authorized servicer in your area. For help finding an authorized servicer in your area, call our toll-free number in Step 1.



3. If you need FSP® replacement parts ...

FSP is a registered trademark of Whirlpool Corporation for quality parts. Look for this symbol of quality whenever you need a replacement part for your ROPER® appliance. FSP replacement parts will fit right and work right, because they are made to the same exacting specifications used to build every new ROPER appliance.

To locate FSP replacement parts in your area, refer to Step 2 or call our toll-free telephone number in Step 1.

4. If you are not satisfied with how the problem was solved ...

- Contact the Major Appliance Consumer Action Program (MACAP). MACAP is a group of independent consumer experts that voices consumer views at the highest levels of the major appliance industry.
- Contact MACAP only when the dealer, authorized servicer, and Whirlpool have failed to resolve your problem.

Major Appliance Consumer Action Program
20 North Wacker Drive
Chicago, IL 60606

- MACAP will in turn inform us of your action.

*When asking for help or service:

Please provide a detailed description of the problem, your appliance's complete model and serial numbers, and the purchase date. (See page 2.) This information will help us respond properly to your request.

ROPER®

Refrigerator Warranty

| LENGTH OF WARRANTY | WE WILL PAY FOR |
|--|---|
| FULL ONE-YEAR WARRANTY (from date of purchase) | FSP® replacement parts and repair labor to correct defects in materials or workmanship. Service must be provided by an authorized Roper service company. |
| FULL FIVE-YEAR WARRANTY (from date of purchase) | FSP replacement parts and repair labor for the sealed refrigeration system (compressor, evaporator, condenser, drier, or connecting tubing) which we find to be defective in materials or workmanship. Service must be provided by an authorized Roper service company. |
| WE WILL NOT PAY FOR | |
| <p>A. Service calls to:</p> <ol style="list-style-type: none"> 1. Correct the installation of your refrigerator. 2. Instruct you how to use your refrigerator. 3. Replace house fuses or correct house wiring or plumbing. 4. Replace light bulbs. <p>B. Repairs when your refrigerator is used in other than normal, single-family household use.</p> <p>C. Pickup and delivery. Your refrigerator is designed to be repaired in the home.</p> <p>D. Damage to your refrigerator caused by accident, misuse, fire, flood, acts of God, or use of products not approved by Whirlpool.</p> <p>E. Repairs to parts or systems caused by unauthorized modifications made to the appliance.</p> | |

5/93

This ROPER appliance is warranted by Whirlpool Corporation. Under no circumstances shall it be liable under this warranty for incidental or consequential damages. Some states do not allow the exclusion or limitation of incidental or consequential damages, so these exclusions or limitations may not apply to you.

This warranty gives you specific legal rights, and you may have other rights which vary from state to state.

Outside the United States, a different warranty may apply. For details, please contact your authorized Roper distributor or military exchange.

If you need service, first see the "Requesting Assistance or Service" section of this book. After checking "Requesting Assistance or Service," additional help can be found by calling our toll-free telephone number, **1-800-44-ROPER (1-800-447-6737)**, from anywhere in the U.S.A.



Printed on recycled paper –
10% post-consumer waste
50% recovered materials

PART NO. 2183013
© 1995 Whirlpool Corporation

® Registered Trademark/TM Trademark of Whirlpool, U.S.A.

5/95
Printed in U.S.A.

Free Manuals Download Website

<http://myh66.com>

<http://usermanuals.us>

<http://www.somanuals.com>

<http://www.4manuals.cc>

<http://www.manual-lib.com>

<http://www.404manual.com>

<http://www.luxmanual.com>

<http://aubethermostatmanual.com>

Golf course search by state

<http://golfingnear.com>

Email search by domain

<http://emailbydomain.com>

Auto manuals search

<http://auto.somanuals.com>

TV manuals search

<http://tv.somanuals.com>