

CABINET DEPTH SIDE BY SIDE REFRIGERATOR

Use & Care Guide

www.whirlpool.com

Table of Contents 2

TABLE OF CONTENTS

REFRIGERATOR SAFETY	3
Proper Disposal of Your Old Refrigerator	3
REFRIGERATOR INSTALLATION	4
Unpacking	4
Location Requirements	4
Electrical Requirements	5
Removing the Door Handles	5
Water Supply Connection	5
Water System Preparation	6
Custom Door Panels	6
Base Grille	7
Leveling Refrigerator	7
Normal Sounds	8
REFRIGERATOR USE	8
Ensuring Proper Air Circulation	8
Using the Controls	8
Water and Ice Dispensers	9
Water Filtration System	10
Ice Maker and Storage Bin/Bucket	11
REFRIGERATOR FEATURES	12
Refrigerator Shelves	12
Meat Drawer, Crisper and Covers	12
Crisper Humidity Control	13
Beverage Drawer	13
Wine or Can/Bottle Rack	13
Utility Bin	13
FREEZER FEATURES	13
Freezer Shelf	13
Freezer Basket	14
DOOR FEATURES	14
Door Rails	14
Door Bins	14
REFRIGERATOR CARE	14
Cleaning	14
Changing the Light Bulbs	15
Power Interruptions	15
Holiday and Moving Care	16
TROUBLESHOOTING	16
ASSISTANCE OR SERVICE	19
Accessories	19
WARRANTY	20

REFRIGERATOR SAFETY

Your safety and the safety of others are very important.

We have provided many important safety messages in this manual and on your appliance. Always read and obey all safety messages.



This is the safety alert symbol.

This symbol alerts you to potential hazards that can kill or hurt you and others.

All safety messages will follow the safety alert symbol and either the word "DANGER" or "WARNING." These words mean:

! DANGER

You can be killed or seriously injured if you don't immediately follow instructions.

! WARNING

You can be killed or seriously injured if you don't follow instructions.

All safety messages will tell you what the potential hazard is, tell you how to reduce the chance of injury, and tell you what can happen if the instructions are not followed.

IMPORTANT SAFETY INSTRUCTIONS

WARNING: To reduce the risk of fire, electric shock, or injury when using your refrigerator, follow these basic precautions:

- Plug into a grounded (earthed) outlet.
- Do not remove ground prong.
- Do not use an adapter.
- Do not use an extension cord.
- Disconnect power before servicing.
- Replace all panels before operating.
- Remove doors from your old refrigerator.
- Use nonflammable cleaner.
- Keep flammable materials and vapors, such as gasoline, away from refrigerator.
- Use two or more people to move and install refrigerator.
- Disconnect power before installing ice maker (on ice maker kit ready models only).
- Use a sturdy glass when dispensing ice or water (on some models).
- The appliance is not intended for use by young children or infirm persons without supervision.
- Young children should be supervised to ensure that they do not play with the appliance.
- If the power supply cord is damaged, it must be replaced by the manufacturer or its service agent or a similarly qualified person in order to avoid a hazard.

SAVE THESE INSTRUCTIONS

Proper Disposal of Your Old Refrigerator

! WARNING

Suffocation Hazard

Remove doors from your old refrigerator.

Failure to do so can result in death or brain damage.

IMPORTANT: Child entrapment and suffocation are not problems of the past. Junked or abandoned refrigerators are still dangerous – even if they will sit for "just a few days." If you are getting rid of your old refrigerator, please follow these instructions to help prevent accidents.

Before you throw away your old refrigerator or freezer:

- Take off the doors.
- Leave the shelves in place so that children may not easily climb inside.

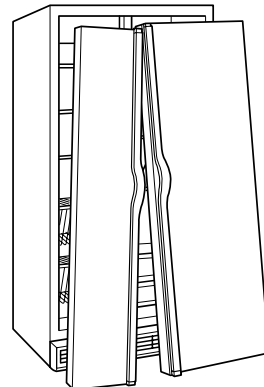

REFRIGERATOR INSTALLATION

Unpacking

⚠ WARNING

Excessive Weight Hazard

Use two or more people to move and install refrigerator.

Failure to do so can result in back or other injury.

Removing packaging materials

- Remove tape and glue residue from surfaces before turning on the refrigerator. Rub a small amount of liquid dish soap over the adhesive with your fingers. Wipe with warm water and dry.
- Do not use sharp instruments, rubbing alcohol, flammable fluids, or abrasive cleaners to remove tape or glue. These products can damage the surface of your refrigerator. For more information, see the "Refrigerator Safety" section.

When Moving Your Refrigerator:

Your refrigerator is heavy. When moving the refrigerator for cleaning or service, be sure to protect the floor. Always pull the refrigerator straight out when moving it. Do not wiggle or "walk" the refrigerator when trying to move it, as floor damage could occur.

Cleaning before use

After you remove all of the packaging materials, clean the inside of your refrigerator before using it. See the cleaning instructions in the "Refrigerator Care" section.

Important information to know about glass shelves and covers:

Do not clean glass shelves or covers with warm water when they are cold. Shelves and covers may break if exposed to sudden temperature changes or impact, such as bumping. For your protection, tempered glass is designed to shatter into many small, pebble-size pieces. This is normal. Glass shelves and covers are heavy. Use special care when removing them to avoid impact from dropping.

Location Requirements

⚠ WARNING



Explosion Hazard

Keep flammable materials and vapors, such as gasoline, away from refrigerator.

Failure to do so can result in death, explosion, or fire.

NOTE: Do not install the refrigerator near an oven, radiator, or other heat source, nor in a location where the temperature will fall below 55°F (13°C).

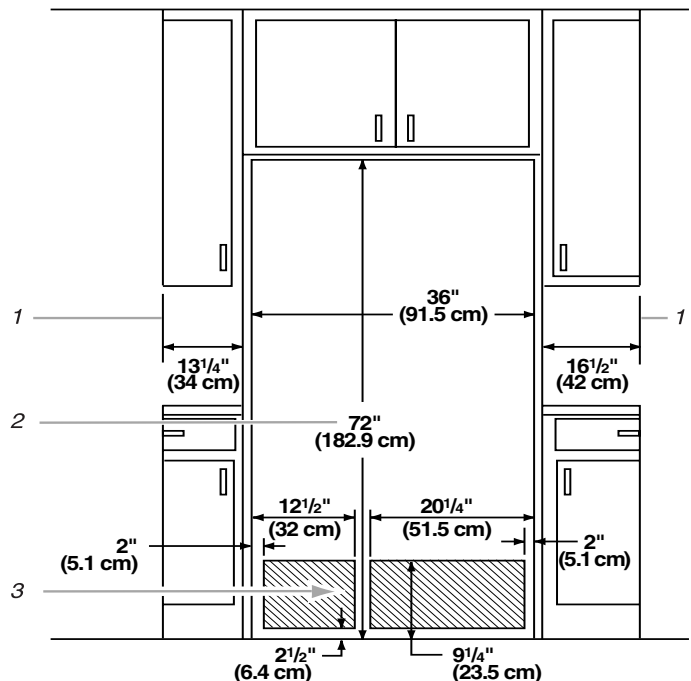

1. Minimum fixed wall position.
2. For full-overlay cabinet doors and a trim kit, the height of the opening must be 72 1/8 in. (183.2 cm).
3. Recommended locations for electrical and water connections.

- If you are installing the refrigerator to fit flush with the front of the base cabinets, all shoe molding and baseboards must be removed from the rear of the refrigerator opening.
- The water hookup and electrical hookup must be placed near the bottom of the refrigerator.
- A trim kit is available for those installations where the refrigerator will not fit flush. See the "Assistance or Service" section for ordering information.

Electrical Requirements

⚠ WARNING



Electrical Shock Hazard

Plug into a grounded (earthed) outlet.

Do not remove ground prong.

Do not use an adapter.

Do not use an extension cord.

Failure to follow these instructions can result in death, fire, or electrical shock.

Before you move your refrigerator into its final location, it is important to make sure you have the proper electrical connection:

Recommended Grounding Method

A 115 Volt, 60 Hz. (Plug 1), 220/240 Volt/50 Hz (Plugs 2 or 3), or 220 Volt/60Hz (Plug 3) AC only 10 ampere fused and grounded (earthed) electrical supply is required.

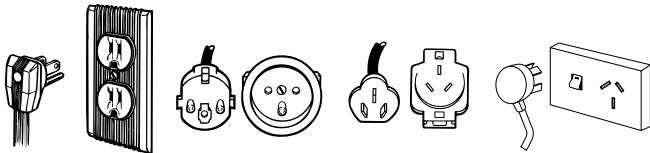

Plug 1

Plug 2

Plug 3

Plug 4

It is recommended that a separate circuit serving only your refrigerator be provided. Use an outlet that cannot be turned off by a switch or pull chain. Do not use an extension cord.

NOTE: Before performing any type of installation, cleaning, or removing a light bulb, turn the control, (Thermostat, Refrigerator or Freezer Control depending on the model) to OFF and then disconnect the refrigerator from the electrical source. When you are finished, reconnect the refrigerator to the electrical source and reset the control (Thermostat, Refrigerator or Freezer Control depending on the model) to the desired setting.

For Australia and New Zealand:

Your new appliance has been especially manufactured to meet all Australian Standards and Conditions.

Some notations in the installation instructions may refer to electrical requirements in other countries, so we draw your particular attention to these specific notes.

Your appliance needs to be plugged into a 230/240 Volt 50 Hz 10 amp (Plug 4) AC only earthed outlet.

Removing the Door Handles

(on some models)

Apply firm pressure with hand on face of trim. Slide top trim up and bottom trim down away from handle, then lift off of shoulder screws. Remove handle screws.



Water Supply Connection

(on some models)

Read all directions carefully before you begin.

IMPORTANT:

- All installations must be in accordance with local plumbing code requirements.
- Contact your dealer or Whirlpool designated service company for proper installation and parts.
- Connect to potable water only.
- Water pressure: 30 to 150 psi (207 KPa - max. 1030 KPa).
- Install ice maker tubing in areas where temperatures are above freezing.
- If operating the refrigerator before installing the water connection, turn ice maker to the OFF position to prevent operation without water (See "Water System Preparation").
- It may take up to 24 hours for your ice maker to begin producing ice.

Water System Preparation

(on some models)

Please read before using the water system.

Immediately after installation, follow the steps below to make sure that the water system is properly cleaned.

1. Open the freezer door and turn off the ice maker by lifting up the wire shutoff arm as shown.

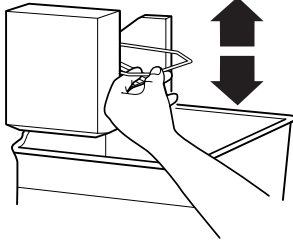

NOTES:

- If your model has a base grille filter system, make sure the base grille filter is properly installed and the cap is in the horizontal position.
 - **Do not use with water that is microbiologically unsafe or of unknown quality without adequate disinfection before or after the system.**
2. Use a sturdy container to depress the water dispenser bar until the water begins to flow. Flush the water system by dispensing and discarding 2 to 3 gal. (8 to 12 L) of water. Cleaning the system will take approximately 6 to 7 minutes and will help clear air from the line. Additional flushing may be required in some households.

NOTE: As air is cleared from the system, water may spurt out of the dispenser.
 3. Open the freezer door and turn on the ice maker by lowering the wire shutoff arm. Please refer to the "Ice Maker and Storage Bin/ Bucket" section for further instructions on the operation of your ice maker.
 - Allow 24 hours to produce the first batch of ice.
 - Discard the first three batches of ice produced.

Dimensions for custom wood panels:

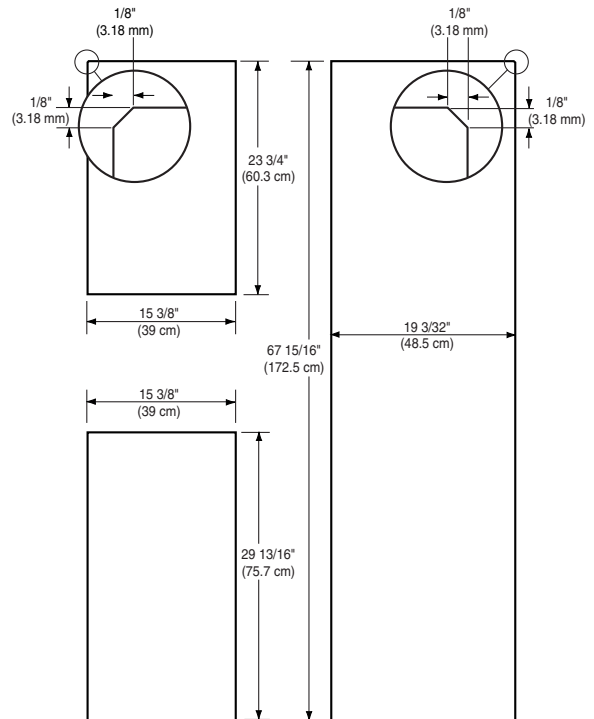

Routing Dimensions for Custom Panels more than 1/4" (6 mm) thick

Handle side detail

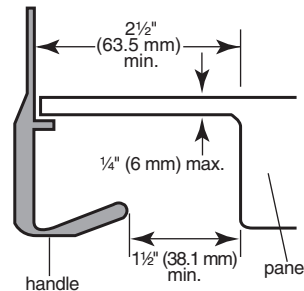

Top, bottom and side trim detail

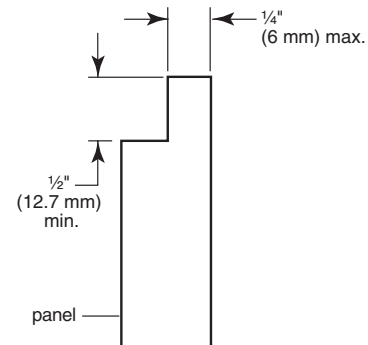

Custom Door Panels

Creating Custom Wood Panels

If you plan to install custom wood decorator panels, you will need to create the panels yourself or consult your cabinet maker or carpenter. See dimensional drawings for wood panel inserts.

Flat panels:

You can create a custom flat panel a maximum of 1/4 in. (6.35 mm) thick to replace your decorator panels. Flat wood panels less than 1/4 in. (6.35 mm) thick are not recommended.

Raised panels:

A raised panel design can be created by screwing or gluing wood panels to 1/4 in. (6.35 mm) backing or by using 3/4 in. (19.05 mm) stock with routed edges. Raised panels should be spaced 2 1/4 in. (5.70 cm) from the back edge of the handle to allow room for fingers to grasp the handle.

Weight requirements for raised panel inserts:

- Refrigerator door panel should not exceed 28 lbs. (12.7 kg).
- Freezer door panels should not exceed 21 lbs. (9.5 kg) combined weight.

Installing Custom Wood Panels

1. Remove any packing tape.
2. Remove the refrigerator and freezer door trims from the hinge side of each door by pulling the trim away from the bottom of the door first.
3. Partially unscrew the two screws that hold the top trim in place. It is not necessary to completely remove the screws. Loosen the screws approximately 1/4 in. (6.35 mm) from the trim to allow the panels to slide freely.

4. Remove the existing door panels, if panels were provided.
5. Slide custom door panels into place.
NOTE: The freezer door panels may require 1/8 in. (3.18 mm) cardboard fillers behind the panels to keep them from being loose in that area.
6. Replace the hinge side trims by inserting the notched end under the top trim first.
7. Tighten the two top trim screws.

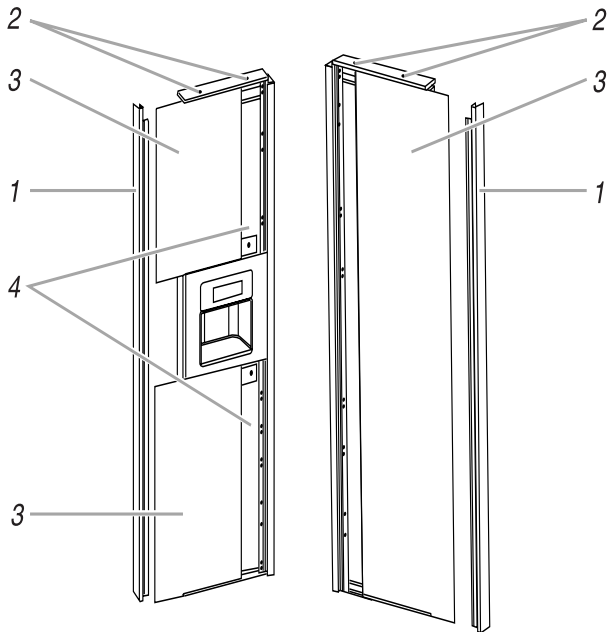

1. Side Trims
2. Top Trim Screws
3. Door Panels
4. Filler Panels

Base Grille

Style 1:

To remove the base grille:

1. Open the refrigerator and freezer doors 90°.
2. Remove screws from the base grille using a screwdriver.

NOTE: Do Not Remove Tech Sheet that is fastened behind the base grille.

To replace the base grille:

1. Open the refrigerator and freezer doors to 90°.
2. Position the base grille in front of the refrigerator and replace the screws.

Style 2:

To remove the base grille:

1. Open the refrigerator and freezer doors to 90°.
2. Grasp the grille with both hands.
3. Lift up and tilt the top of the grille toward you.

NOTE: Do not remove the Tech Sheet that is fastened behind the grille.

To replace the base grille:

1. Open the refrigerator and freezer doors to 90°.
2. Place the lower clips in the openings in the metal panel.

3. Roll the grille up toward the refrigerator until it snaps into place.

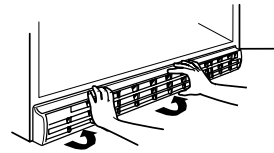

Leveling Refrigerator

Your refrigerator has a front and rear roller at the base of the product on each side. All four rollers can be adjusted from the front of the product. If your refrigerator seems unsteady or you want the doors to close easier, adjust the refrigerator's tilt using the instructions below:

1. Check the installation location to be sure that you have the proper clearance for the refrigerator. (See the "Location Requirements" section.)
2. Plug into a grounded (earthed) outlet.
3. Move the refrigerator into its final position.
4. Open the refrigerator and freezer doors to locate the leveling bolts at the left and right of the refrigerator base. If your refrigerator has a base grille, remove it (see "Base Grille" earlier in this section).

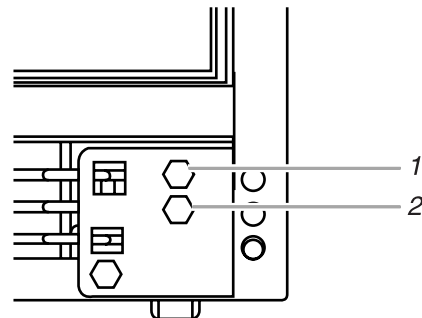

1. Rear Leveling Bolt (yellow)
2. Front Leveling Bolt (silver)

NOTE: The yellow (top) bolt will adjust the rear of the refrigerator, and the silver (bottom) bolt will adjust the front of the refrigerator.

5. Use a 1/2 in. (12.70 mm) socket wrench to adjust the leveling bolts. Turn the leveling bolt to the right to raise that side of the refrigerator or turn the leveling bolt to the left to lower that side. It may take several turns of the leveling bolts to adjust the tilt of the refrigerator.

NOTE: Be careful not to unscrew the leveling bolts too much when lowering the refrigerator. The bolt head will start to come away from the refrigerator when in the lowest position. If the screw does come out of the rear roller bracket, the compartment access cover on the back of the refrigerator will have to be removed to reinstall the bolt.

REFRIGERATOR USE

Ensuring Proper Air Circulation

In order to ensure proper temperatures, you need to permit airflow between the two sections. Cold air enters the bottom of the freezer section and moves up. It then enters the refrigerator section through the top vent. Air then returns to the freezer as shown.

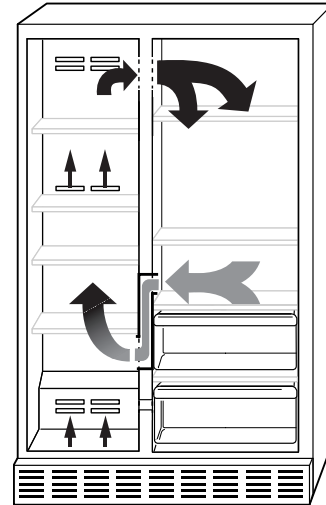

Do not block any of these vents with food such as soda, cereal, bread, etc. If the vents are blocked, airflow will be prevented and the temperature controls will not function properly.

IMPORTANT: Because air circulates between both sections, any odors formed in one section will transfer to the other. You must thoroughly clean both sections to eliminate odors. To prevent odor transfer from food, wrap or cover foods tightly.

- Adjust the front leveling bolt to bring the refrigerator top parallel with the cabinet above the refrigerator. For standard cabinets, leave approximately $\frac{1}{8}$ in. (3.18 mm) gap between the top hinges and the cabinet. For full-overlay cabinets, leave $\frac{1}{4}$ in. (6.35 mm) gap for leveling. If you do not have a cabinet above the refrigerator, simply adjust the refrigerator to make it level.

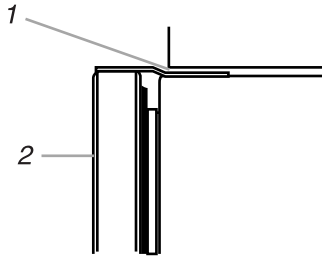

- For standard cabinets, leave $\frac{1}{8}$ in. (3.18 mm) minimum clearance for leveling the refrigerator. For full-overlay cabinets, leave $\frac{1}{4}$ in. (6.35 mm) minimum clearance for leveling and door clearance.
- Front of the refrigerator.

- Adjust the rear leveling bolt to bring the refrigerator level with the side cabinets or cabinet end panels.
- If you want, you may now use the four leveling bolts to raise the refrigerator to close the gap between the refrigerator top hinge and the cabinet opening. Check that all four rollers still touch the floor and that the cabinet doors above the refrigerator open all the way.
- Replace the base grille.

Normal Sounds

Your new refrigerator may make sounds that your old one didn't make. Because the sounds are new to you, you might be concerned about them. Most of the new sounds are normal. Hard surfaces, such as the floor, walls, and cabinets, can make the sounds seem louder. The following describes the kinds of sounds and what may be making them.

- If your product is equipped with an ice maker, you will hear a buzzing sound when the water valve opens to fill the ice maker for each cycle.
- Your refrigerator is designed to run more efficiently to keep your food items at the desired temperatures and to minimize energy usage. The high efficiency compressor and fans may cause your refrigerator to run longer than your old one. You may also hear a pulsating or high-pitched sound from the compressor or fans adjusting to optimize performance.
- You may hear the evaporator fan motor circulating air through the refrigerator and freezer compartments. The fan speed may increase as you open the doors or add warm food.
- Rattling noises may come from the flow of refrigerant, the water line, or items stored on top of the refrigerator.
- Water dripping on the defrost heater during a defrost cycle may cause a sizzling sound.
- As each cycle ends, you may hear a gurgling sound due to the refrigerant flowing in your refrigerator.
- Contraction and expansion of the inside walls may cause a popping noise.
- You may hear air being forced over the condenser by the condenser fan.
- You may hear water running into the drain pan during the defrost cycle.

Using the Controls

Electronic Controls

For your convenience, your controls are preset at the factory. When installing your refrigerator, make sure that the controls are still preset to the "mid-settings" as shown. To view settings, press the POWER (ON/OFF) button.

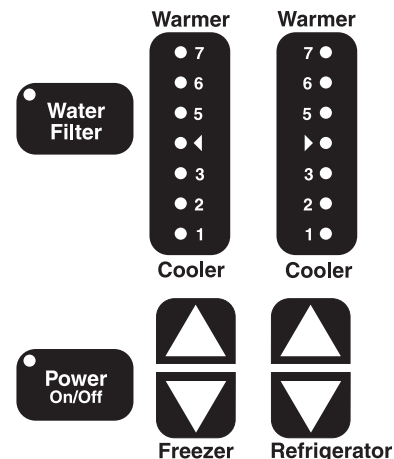

IMPORTANT:

- Your product will not cool when the Power Control is set to OFF.
- The Refrigerator Control adjusts the refrigerator compartment temperature. The Freezer Control adjusts the freezer compartment temperature. Press the UP ARROW to make the temperature warmer. Press the DOWN ARROW to make the temperature colder.
- Wait 24 hours before you put food into the refrigerator. If you add food before the refrigerator has cooled completely, your food may spoil.
NOTE: Adjusting the Refrigerator and Freezer Controls to a higher (colder) setting will not cool the compartments any faster.
- The preset settings should be correct for normal household usage. The controls are set correctly when milk or juice is as cold as you like and when ice cream is firm.
- If the temperature is too warm or too cold in the refrigerator or freezer, first check the air vents to be sure they are not blocked before adjusting the controls.

Adjusting Controls

If you need to adjust temperatures, adjust the refrigerator temperature first. Wait 24 hours between adjustments and then recheck the temperatures.

CONDITION/REASON:	SETTING ADJUSTMENT:
REFRIGERATOR too cold Controls not set correctly for your conditions	Press REFRIGERATOR Control UP ARROW to move the control to the next higher setting
REFRIGERATOR too warm Door opened often, large amount of food added or room temperature very warm	Press REFRIGERATOR Control DOWN ARROW to move the control to the next lower setting
FREEZER too cold Controls not set correctly for your conditions	Press FREEZER Control UP ARROW to move the control to the next higher setting
FREEZER too warm/too little ice Door opened often, or large amount of food added or very cold room temperature (can't cycle often enough) or heavy ice usage	Press FREEZER Control DOWN ARROW to move the control to the next lower setting

Water and Ice Dispensers

(on some models)

! WARNING



Cut Hazard

Use a sturdy glass when dispensing ice or water.
Failure to do so can result in cuts.

Depending on your model, you may have one or more of the following options: the ability to select either crushed or cubed ice, a special light that turns on when you use the dispenser, or a lock option to avoid accidental dispensing.

The Ice Dispenser

Ice dispenses from the ice maker storage bin in the freezer. When the dispenser lever is pressed:

- A trap door opens in a chute between the dispenser and the ice bin. Ice moves from the bin and falls through the chute.
- When you release the dispenser lever, the trap door closes and the ice dispensing stops. The dispensing system will not operate when the freezer door is open.

Some models dispense both cubed and crushed ice. Before dispensing ice, select which type of ice you prefer. The button controls are designed for easy use and cleaning.

- For cubed ice, press the CUBE button until the red indicator appears in the window above the CUBE button.

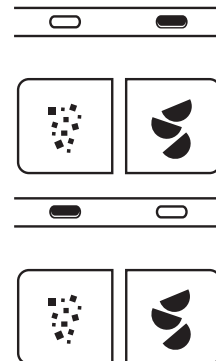

- For crushed ice, press the CRUSH button until the red indicator appears in the window above the CRUSH button.

For crushed ice, cubes are crushed before being dispensed. This may cause a slight delay when dispensing crushed ice. Noise from the ice crusher is normal, and pieces of ice may vary in size. When changing from CRUSH to CUBE, a few ounces of crushed ice will be dispensed along with the first cubes.

To dispense ice:

1. Press button for the desired type of ice.
2. Press a sturdy glass against the ice dispenser lever. Hold the glass close to the dispenser opening so ice does not fall outside of the glass.

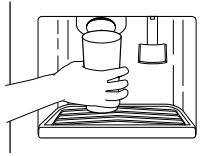

IMPORTANT: You do not need to apply a lot of pressure to the lever in order to activate the ice dispenser. Pressing hard will not make the ice dispense faster or in greater quantities.

3. Remove the glass to stop dispensing.

NOTE: The first few batches of ice may have an off-flavor from new plumbing and parts. Throw the ice away. Also, take large amounts of ice from the ice bin, not through the dispenser.

The Water Dispenser

If you did not flush the water system when the refrigerator was first installed, press the water dispenser bar with a glass or jar until you draw and discard 2 to 3 gal. (8 to 12 L) or approximately 6 to 7 minutes of water after water begins dispensing. It will take 3 to 4 minutes for the water to begin dispensing. The water you draw and discard cleans the system and helps clear air from the lines. Allow several hours for the refrigerator to cool down and chill water.

IMPORTANT: Depending on your model, the small removable tray at the bottom of the dispenser is designed to catch small spills and allow for easy cleaning. There is no drain in the tray. The tray can be removed from the dispenser and carried to the sink to be emptied or cleaned.

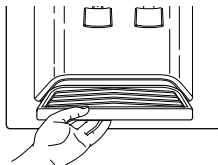

To dispense water:

1. Press a glass against the water dispenser lever.
2. Remove the glass to stop dispensing.

NOTE: Dispense enough water every week to maintain a fresh supply.

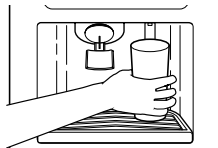

The Dispenser Light

The dispenser area has a light. It can be turned on manually by pressing the ON button at the right hand side of the control panel. The red indicator above the ON button will appear.

On some models: Whenever you use the dispenser the lever will automatically turn the light on.



NOTE: See the “Changing the Light Bulbs” section for information on changing the dispenser light bulb.

On models without crushed ice, the light switch is a rocker-style type. Push the switch to turn the light on, and push again to turn the light off.

The Dispenser Lock (on some models)

Your dispenser can be turned off for easy cleaning or to prevent accidental dispensing by small children and pets. To turn off the dispenser, press the LOCK button. The indicator will appear above the LOCK button and the ice and water dispensers will not work. To unlock the dispenser, press the UNLOCK button until the indicator appears. Then continue to dispense ice or water as usual.



NOTE: The lock feature does not shut off power to the product, to the ice maker, or to the dispenser light. It simply deactivates the dispenser levers.

Water Filtration System

(on some models)

The water filter indicator light

The water filter indicator light will help you know when to change your water filter cartridge. The light is located at the top of the refrigerator compartment. The light will change from green to yellow. This tells you that it is almost time to change the water filter cartridge (90% of the filter life has been used). It is recommended that you replace the water filter cartridge when the water filter indicator light changes to red OR water flow to your water dispenser or ice maker decreases noticeably. (See “Changing a water filter cartridge” later in this section.)

NOTE: Do not use with water that is microbiologically unsafe or of unknown quality without adequate disinfection before or after the system.

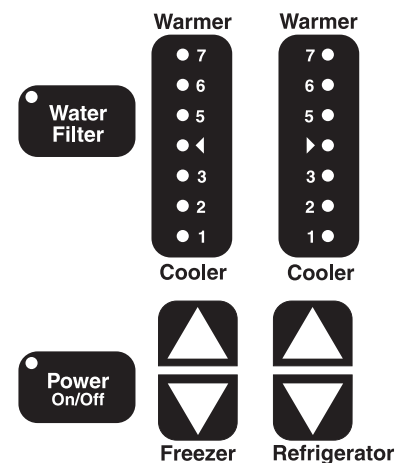

After changing the water filter cartridge, reset the water filter indicator light by pressing the WATER FILTER button 5 times. The indicator light will change from red to green when the system is reset.

Changing a water filter cartridge

The water filter is located below the freezer compartment door.

1. Locate the water filter cartridge cap in the front base grille below the freezer compartment door. Rotate the cap counterclockwise to a vertical position and pull the cap and filter cartridge out through the base grille.

NOTE: There will be water in the cartridge. Some spilling may occur.

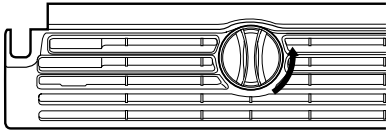

2. Remove the cartridge cap by sliding it off the end of the old cartridge. The cap will slide to the left or right. **DO NOT DISCARD THE CAP.**

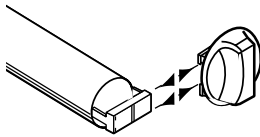

3. Take the new cartridge out of its packaging and remove protective cover from o-rings.

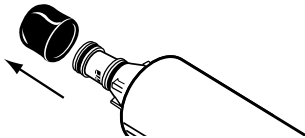

4. Slide the cartridge cap onto the new cartridge as shown in Step 2.
5. With cartridge cap in the vertical position, push the new filter cartridge into the base grille until it stops. Rotate the cartridge cap clockwise to a horizontal position.

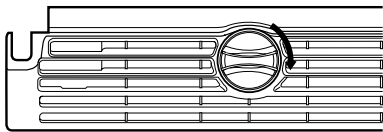

6. **RUN WATER THROUGH THE DISPENSER UNTIL THE WATER RUNS CLEAR** (about 2 to 3 gal. or 6 to 7 minutes). This will clean the system and clear air from the lines. Additional flushing may be required in some households.

NOTE: As air is cleared from the system, water may spurt out of the dispenser.

Using the dispenser without the water filter

You can run the dispenser without a water filter cartridge. Your water will not be filtered. If you run the dispenser without a water filter cartridge, keep the cartridge cap and replace it in the base grille for future use.

1. Remove the water filter cartridge (See "Changing a water filter cartridge" earlier in this section.) Then slide the cartridge cap off the end of the filter cartridge. **DO NOT DISCARD THE CAP.**
2. With the cartridge cap in the vertical position, insert the cap into the base grille until it stops.

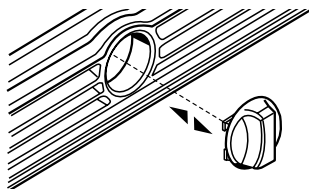

3. Rotate the cartridge cap to a horizontal position as shown in Step 5. (See "Changing a water filter cartridge" earlier in this section.)

NOTE: The cartridge cap may not be even with the base grille.

Ordering replacement filters

To order more water filter cartridges, see the "Accessories" section in the "Assistance or Service" section.

Ice Maker and Storage Bin/Bucket

(on some models - Accessory)

To turn the ice maker on/off:

The on/off switch for the ice maker is a wire shutoff arm located on the side of the ice maker.

1. To turn the ice maker on, simply lower the wire shutoff arm.

NOTE: Your ice maker has an automatic shutoff. As ice is made, the ice cubes will fill the ice storage bin and the ice cubes will raise the wire shutoff arm to the OFF (arm up) position.

2. To manually turn the ice maker off, lift the wire shutoff arm to the OFF (arm up) position and listen for the click to make sure the ice maker will not continue to operate.

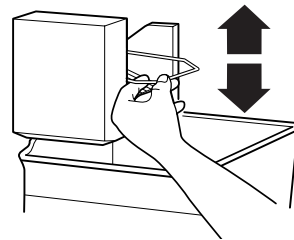

To remove and replace the ice bin:

1. Pull the covering panel out from the bottom and then slide it back toward the rear.
2. Lift the wire shutoff arm so it clicks into the OFF (up) position. Ice can still be dispensed, but no more can be made.
3. Lift up the front of the storage bin and pull it out.

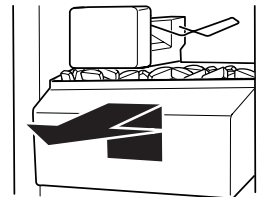

4. Replace the bin by pushing it in all the way or the dispenser will not work. Push the wire shutoff arm down to the ON position to restart ice production. Make sure the door is closed tightly.

To care for ice storage bin:

1. Empty the ice bin. Use warm water to melt the ice if necessary. Never use anything sharp to break up the ice in the bin. This can cause damage to the ice container and the dispenser mechanism.
2. Wash ice bin with a mild detergent, rinse well and dry thoroughly. Do not use harsh or abrasive cleaners or solvents.

REMEMBER:

- Allow 24 hours to produce the first batch of ice.
- Discard the first three batches of ice produced to avoid impurities that may be flushed out of the system.
- The quality of your ice will be only as good as the quality of the water supplied to your ice maker.
- Avoid connecting the ice maker to a softened water supply. Water softener chemicals (such as salt) can damage parts of the ice maker and lead to poor quality ice. If a softened water supply cannot be avoided, make sure the water softener is operating properly and is well maintained.
- It is normal for the ice cubes to be attached at the corners. They will break apart easily.
- Do not force the wire shutoff arm up or down.
- Do not store anything on top of the ice maker or in the ice storage bin.

REFRIGERATOR FEATURES

Your model may have some or all of these features. Features that can be purchased separately as product accessories are labeled with the word "Accessory." Not all accessories will fit all models. If you are interested in purchasing one of the accessories, contact your authorized Whirlpool dealer.

Important information to know about glass shelves and covers:

Do not clean glass shelves or covers with warm water when they are cold. Shelves and covers may break if exposed to sudden temperature changes or impact, such as bumping. For your protection, tempered glass is designed to shatter into many small, pebble-size pieces. This is normal. Glass shelves and covers are heavy. Use special care when removing them to avoid impact from dropping.

Refrigerator Shelves

Your model may have glass or wire shelves. Store similar foods together and adjust the shelves to fit different heights. This reduces the time the refrigerator door is open and saves energy.

Slide-out Shelves (on some models)

To remove and replace a shelf in a metal frame:

1. Pull the shelf forward to the stop. Tilt the front of the shelf up and lift it slightly as you pull the shelf from the frame.
2. Replace the shelf by guiding it back into the slots on the frame and pushing the shelf in past the stop.

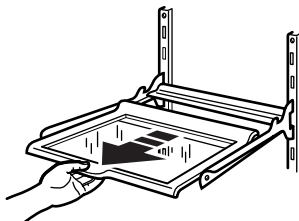

Shelves and Shelf Frames

To remove and replace a shelf/frame:

1. Remove the shelf/frame by tilting it up at the front and lifting it out of the shelf supports.
2. Replace the shelf/frame by guiding the rear shelf hooks into the shelf supports. Tilt the front of the shelf up until rear shelf hooks drop into the shelf supports. Check to make sure that the shelf is securely in position.

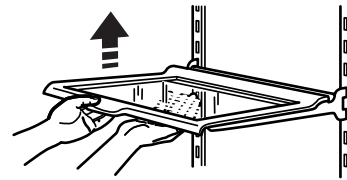

Meat Drawer, Crisper and Covers (on some models)

To remove and replace the crisper and meat drawers:

1. Slide crisper or meat drawer straight out to the stop. Lift the front of drawer with one hand while supporting the bottom of drawer with other hand and slide the drawer out the rest of the way.
2. Replace the crisper or meat drawer by sliding it back in fully past the drawer stop.

To remove and replace the crisper or meat drawer covers:

1. Remove the crisper and meat drawer. Press up in center of crisper glass insert until it rises above the plastic frame. Holding the crisper glass firmly, carefully slide the glass insert forward to remove.
2. Lift crisper cover frame and remove. Repeat steps to remove the meat drawer cover.

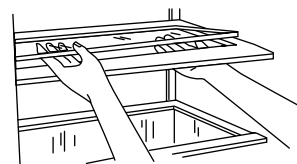

3. Replace back of meat drawer cover frame into supports or slides on side walls of the refrigerator and lower or slide the front of the cover frame into place.
4. Slide rear of glass insert into cover frame and lower front into place. Repeat steps to replace the crisper cover.

Meat storage guide

Store most meat in original wrapping as long as it is airtight and moisture-proof. Rewrap if necessary. See the following chart for storage times. When storing meat longer than the times given, freeze the meat.

Fresh fish or shellfish..... use same day as purchased
Chicken, ground beef, variety meat (liver, etc.) 1-2 days
Cold cuts, steaks/roasts 3-5 days
Cured meats 7-10 days
Leftovers - Cover leftovers with plastic wrap, aluminum foil, or plastic containers with tight lids.

Crisper Humidity Control

(on some models)

You can control the amount of humidity in the moisture-sealed crisper. Adjust the control to any setting between LOW and HIGH.

LOW (open) lets moist air out of the crisper for best storage of fruits and vegetables with skins.

- **Fruit:** Wash, let dry and store in refrigerator in plastic bag or crisper. Do not wash or hull berries until they are ready to use. Sort and keep berries in original container in crisper, or store in a loosely closed paper bag on a refrigerator shelf.
- **Vegetables with skins:** Place in plastic bag or plastic container and store in crisper.

HIGH (closed) keeps moist air in the crisper for best storage of fresh, leafy vegetables.

- **Leafy vegetables:** Wash in cold water, drain and trim or tear off bruised and discolored areas. Place in plastic bag or plastic container and store in crisper.

Humidity control location:

- Humidity Control on crisper drawer (**Style 1** - on left)
- Humidity Control on crisper cover (**Style 2** - on right)

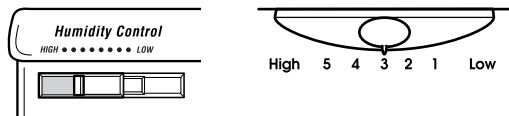

Beverage Drawer

To remove and replace the beverage drawer:

1. Remove the beverage drawer by sliding it straight out to the stop. Lift up at the front and slide the beverage drawer out the rest of the way.
2. Replace the beverage drawer by sliding it back in fully past the stop.

To remove and replace the beverage drawer shield:

1. Remove the beverage drawer shield by grasping it at the bottom center. Pull up in the center while turning the shield slightly to one side.
2. Replace the shield by grasping it at the bottom center and inserting one side into the beverage drawer cover.
3. Carefully bend the shield at the center to insert the other side into the cover.

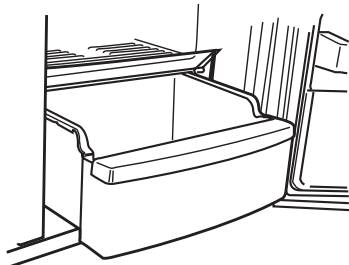

Wine or Can/Bottle Rack

(on some models - Accessory)

To remove and replace the wine rack (left) or can/bottle rack (right):

1. Remove the rack by pulling it straight out from the shelf.
2. Replace the rack by sliding it in between the shelf and the wall of the refrigerator.

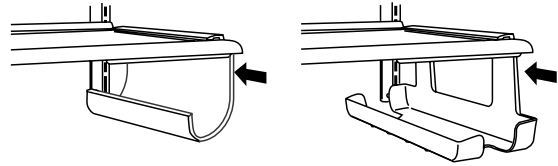

Utility Bin

(on some models - Accessory)

NOTE: For long-term storage, store eggs in a covered container or in their original carton on an interior shelf.

FREEZER FEATURES

Your model may have some or all of these features. Features that can be purchased separately as product accessories are labeled with the word "Accessory." Not all accessories will fit all models. If you are interested in purchasing one of the accessories, contact your authorized Whirlpool dealer.

Freezer Shelf

To remove and replace the shelf:

1. Remove the shelf by lifting it up and pulling it straight out.
2. Replace the shelf by putting it over the supports and lowering it into place.

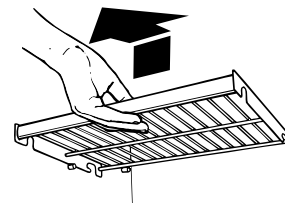

Frozen food storage guide

Storage times will vary according to the quality and type of food, the type of packaging or wrap used (should be airtight and moisture-proof), and the storage temperature. Ice crystals inside a sealed package are normal. This simply means that moisture in the food and air inside the package have condensed, creating ice crystals.

Put no more unfrozen food into the freezer than will freeze within 24 hours (no more than 2 to 3 lbs. of food per cubic foot [907 to 1,350 g per L] of freezer space). Leave enough space in the freezer for air to circulate around packages. Be careful to leave enough room for the door to close tightly.

For more information on preparing food for freezing, check a freezer guide or reliable cookbook.

Freezer Basket

(plastic bin on some models)

The freezer basket can be used to store bags of frozen fruits and vegetables that may slide off freezer shelves.

To remove and replace the freezer basket:

1. Remove basket by sliding it out to the stop.
2. Lift the front of the basket and slide it out the rest of the way.

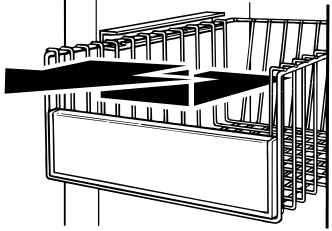

3. Replace the basket by positioning it on the side wall guide rails. Lift the basket front slightly while pushing it past the guide rail stops and slide basket in the rest of the way.

DOOR FEATURES

Your model may have some or all of these features. Features that can be purchased separately as product accessories are labeled with the word "Accessory." Not all accessories will fit all models. If you are interested in purchasing one of the accessories, contact your authorized Whirlpool dealer.

Door Rails

The door rails may be removed for easier cleaning.

Snap-on Door Rails

To remove and replace the rails:

1. Remove the rails by pushing in slightly on the front of the bracket while pulling out on the inside tab. Repeat these steps for the other end of the rail.
2. Replace the rails by aligning the ends of the brackets with the buttons on the sides of the door liner. Firmly snap bracket and rail assembly onto the tabs above the shelf as shown.



Drop-in Door Rails

To remove and replace the rails:

1. Remove the rails by pulling straight up on each end of the rail.
2. Replace the rails by sliding the shelf rail into the slots on the door and pushing the rail straight down until it stops.

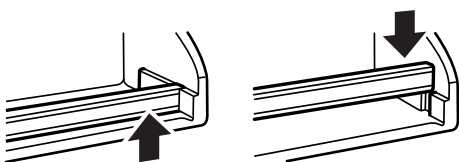

Door Bins

Large door bins hold gallon containers and the smaller door bins hold 2-liter bottles. The door bins are removable for easy cleaning and adjusting.

NOTE: Place large door bins in the upper part of the refrigerator door so the door will close properly. Small door bins will fit in either the upper or lower part of the door.

To remove and replace the door bins:

1. Remove the bin by lifting it up and pulling it out.
2. Replace the bin by insert the hooks into the slots on both sides of the refrigerator door. Push the bin down to lock it into place.

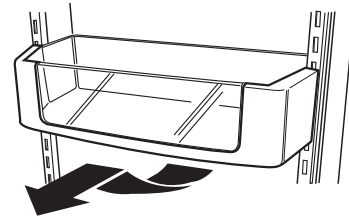

REFRIGERATOR CARE

Cleaning

! WARNING



Explosion Hazard

Use nonflammable cleaner.

Failure to do so can result in death, explosion, or fire.

Both the refrigerator and freezer sections defrost automatically. However, clean both sections about once a month to prevent odors from building up. Wipe up spills immediately.

Cleaning your refrigerator

1. Unplug refrigerator or disconnect power.
2. Remove all removable parts from inside, such as shelves, crispers, etc.
3. Hand wash, rinse, and dry removable parts and interior surfaces thoroughly. Use a clean sponge or soft cloth and a mild detergent in warm water.
 - Do not use abrasive or harsh cleaners such as window sprays, scouring cleansers, flammable fluids, cleaning waxes, concentrated detergents, bleaches or cleansers containing petroleum products on plastic parts, interior and door liners or gaskets. Do not use paper towels, scouring pads, or other harsh cleaning tools. These can scratch or damage materials.
 - To help remove odors, you can wash interior walls with a mixture of warm water and baking soda (2 tbs. to 1 qt. [26 g to .95 L] of water).

- Wash stainless steel and painted metal exteriors with a clean sponge or soft cloth and a mild detergent in warm water. Do not use abrasive or harsh cleaners. Dry thoroughly with a soft cloth. For additional protection against damage to painted metal exteriors, apply appliance wax (or auto paste wax) with a clean, soft cloth. Do not wax plastic parts.

NOTE: To keep your Stainless Steel refrigerator looking like new and to remove minor scuffs or marks, it is suggested that you use the manufacturer's approved Stainless Steel Cleaner & Polish.

IMPORTANT: This cleaner is for Stainless Steel parts only!

Do not allow the Stainless Steel Cleaner & Polish to come into contact with any plastic parts such as the trim pieces, dispenser covers or door gaskets. If accidental contact does occur, clean plastic part with a sponge and mild detergent in warm water. Dry thoroughly with a soft cloth. To order the cleaner, see the "Accessories" section.

- There is no need for routine condenser cleaning in normal home operating environments. If the environment is particularly greasy or dusty, or there is significant pet traffic in the home, the condenser should be cleaned every two to three months to ensure maximum efficiency.

If you need to clean the condenser:

- Remove the base grille (see "Base Grille" or "Door Removal" section).
- Use a vacuum with a soft brush to clean the grille, the open areas behind the grille and the front surface area of the condenser.
- Replace the base grille when finished.

- Plug in refrigerator or reconnect power.

Changing the Light Bulbs

NOTE: Not all appliance bulbs will fit your refrigerator. Be sure to replace the bulb with one of the same size and shape. The dispenser light requires a heavy duty 10-watt bulb. All other lights require a 40-watt appliance bulb. Replacement bulbs are available from your dealer.

- Unplug refrigerator or disconnect power.
- Remove light shield when applicable as shown.

NOTE: To clean a light shield, wash it with warm water and a liquid detergent. Rinse and dry the shield well.
- Remove light bulb and replace with one of the same size, shape and wattage.
- Replace light shield when applicable as shown.
- Plug in refrigerator or reconnect power.

Dispenser Light (on some models)

Reach through the dispenser area to remove and replace light bulb.

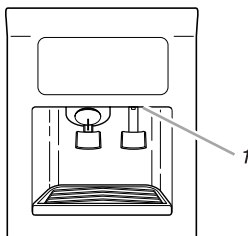

1. Dispenser Light

Control Panel Light

Reach behind the refrigerator control panel to remove and replace light bulb.

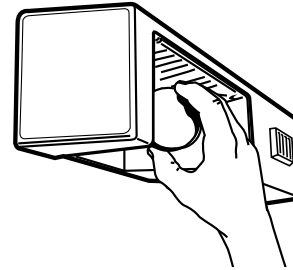

Crisper Light or Upper Freezer Light (on some models):

- Remove light shield by grasping the top center of the shield and pulling forward while turning it slightly to one side. If necessary, remove top crisper drawer to access crisper light shield.
- Replace the light shield by inserting the tabs on one end into the slotted holes in the refrigerator or freezer liner. Then, carefully bend the shield at the center to insert the tabs on the other end.



Lower Freezer Light Beneath Ice Bin (on some models):

- Remove the light shield by grasping the sides and squeezing in toward the center. Once the side hooks of shield are free from the freezer lining, pull down the shield.
- Replace the light shield by squeezing the sides toward the center and inserting the side hooks into the slotted holes. Once the side hooks are in place, snap the front tab into the slotted hole.

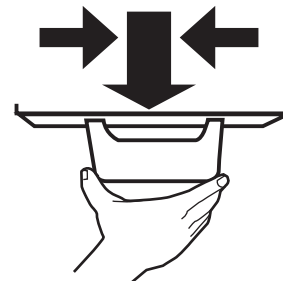

Power Interruptions

If the power will be out for 24 hours or less, keep both refrigerator doors closed to help food stay cold and frozen.

If the power will be out for more than 24 hours, do one of the following:

- Remove all frozen food and store it in a frozen food locker.
- Place 2 lbs. (907 g) of dry ice in the freezer for every cubic foot (28 L) of freezer space. This will keep the food frozen for two to four days.
- If neither a food locker nor dry ice is available, consume or can perishable food at once.

REMEMBER: A full freezer stays cold longer than a partially filled one. A freezer full of meat stays cold longer than a freezer full of baked goods. If you see that food contains ice crystals, it may be refrozen, although the quality and flavor may be affected. If the condition of the food is poor, dispose of it.

Holiday and Moving Care

Holidays

If you choose to leave the refrigerator on while you're away, use these steps to prepare your refrigerator before you leave.

1. Use up any perishables and freeze other items.
2. If your refrigerator has an automatic ice maker:
 - Raise wire shutoff arm to OFF (up) position.
 - Shut off water supply to the ice maker.
3. Empty the ice bin.

If you choose to turn the refrigerator off before you leave, follow these steps.

1. Remove all food from the refrigerator.
 2. If your refrigerator has an automatic ice maker:
 - Turn off the water supply to the ice maker at least one day ahead of time.
 - When the last load of ice drops, raise the wire shutoff arm to the OFF (up) position.
 3. Depending on your model, turn the Thermostat Control (or Refrigerator Control, depending on the model) to OFF. See the "Setting or Using the Controls" section.
 4. Clean refrigerator, wipe it, and dry well.
 5. Tape rubber or wood blocks to the tops of both doors to prop them open far enough for air to get in. This stops odor and mold from building up. Take care not to damage the door seal with the blocks.
-

Moving

When you are moving your refrigerator to a new home, follow these steps to prepare it for the move.

1. If your refrigerator has an automatic ice maker:
 - Turn off the water supply to the ice maker at least one day ahead of time.
 - Disconnect the water line from the back of the refrigerator.
 - When the last load of ice drops, raise the wire shutoff arm to the OFF (up) position.
2. Remove all food from the refrigerator and pack all frozen food in dry ice.
3. Depending on your model, turn the Thermostat Control (or Refrigerator Control, depending on the model) to OFF. See the "Setting or Using the Controls" section.
4. Unplug the refrigerator.
5. Empty water from the defrost pan. The pan is located behind the base grille.
6. Clean, wipe, and dry thoroughly.
7. Take out all removable parts, wrap them well, and tape them together so they don't shift and rattle during the move.
8. Depending on the model, raise the front of the refrigerator so it rolls more easily OR screw in the leveling legs so they don't scrape the floor. See the "Door Closing" section.
9. Tape the doors shut and the power cord to the refrigerator cabinet.

When you get to your new home, put everything back and refer to the "Refrigerator Installation" section for preparation instructions. Also, if your refrigerator has an automatic ice maker, remember to reconnect the water supply to the refrigerator.

TROUBLESHOOTING

Try the solutions suggested here first in order to avoid the cost of an unnecessary service call.

Your refrigerator will not operate

- **Is the power supply cord unplugged?** Plug into a grounded (earthed) outlet.
 - **Has a household fuse or circuit breaker tripped?** Replace the fuse or reset the circuit breaker.
 - **Is the refrigerator or freezer control turned to the OFF position?** Refer to the "Setting or Using the Controls" section.
 - **Is the refrigerator defrosting?** Recheck to see if the refrigerator is operating in 30 minutes. Your refrigerator will regularly run an automatic defrost cycle.
 - **Is the refrigerator not cooling?** For models with digital controls, turn the unit OFF then ON again to reset. See the "Setting or Using the Controls" section. If this does not correct the problem, call for service.
-

The lights do not work

- **Is the power supply cord unplugged?** Plug into a grounded (earthed) outlet.
 - **Is a light bulb loose in the socket or burned out?** See the "Changing the Light Bulb(s)" section.
-

There is water in the defrost drain pan

- **Is the refrigerator defrosting?** The water will evaporate. It is normal for water to drip into the defrost pan.
 - **Is it more humid than normal?** When it is humid, expect that the water in the defrost pan will take longer to evaporate.
-

The motor seems to run too much

- **Is the room temperature hotter than normal?** The motor will run longer under warm conditions. At normal room temperatures, expect your motor to run about 40% to 80% of the time. Under warmer conditions, it will run even more.
- **Has a large amount of food just been added to the refrigerator?** Adding a large amount of food warms the refrigerator. The motor normally will run longer to cool the refrigerator back down.
- **Are the doors opened often?** The motor will run longer when this occurs. Conserve energy by getting all items out at one time, keeping food organized, and closing the door as soon as possible.
- **Are the controls not set correctly for the surrounding conditions?** Refer to the "Setting or Using the Controls" section.
- **Are the doors not closed completely?** Close the doors firmly. If they do not close completely, see "The doors will not close completely" later in this section.

- **Are the condenser coils dirty?** This prevents air transfer and makes the motor work harder. Clean the condenser coils. Refer to the “Cleaning” section.
 - **Are the door gaskets not sealed all the way around?** Contact a technician or other qualified person.
- NOTE:** Your new refrigerator will run longer than your old one due to its high-efficiency motor.

The refrigerator seems to make too much noise

- The sounds may be normal for your refrigerator. See the “Normal Sounds” section.

The ice maker is not producing ice or not enough ice

- **Has the ice maker just been installed?** Wait 72 hours for full ice production to begin. Once your refrigerator is cooled, the ice maker should produce 70 to 120 cubes every 24 hours.
- **Is the freezer temperature cold enough to produce ice?** Wait 24 hours after ice maker hook-up for ice production. See the “Setting or Using the Controls” section.
- **Is the ice maker wire shutoff arm in the OFF (arm up) position (on some models)?** Lower the wire shutoff arm to the ON (arm down) position. See the “Ice Maker and Storage Bin/Bucket” section.
- **Is the ice maker switch in the OFF (right) position (on some models)?** Move ice maker switch to the ON (left) position. See the “Ice Maker and Storage Bin/Bucket” section.
- **Is the water line shutoff valve to the refrigerator turned on?** Turn on the water valve. See the “Water Supply Connection” section.
- **Does the ice maker mold have water in it or has no ice been produced?** Make sure your refrigerator has been connected to a water supply and the supply shutoff valve is turned on. See the “Water Supply Connection” section.
- **Is an ice cube jammed in the ice maker ejector arm?** For models with an interior ice bin, remove the ice from the ejector arm with a plastic utensil. For models with an ice bucket located on the freezer door, access the ice maker by depressing the ice sensor door on the upper left side of the freezer interior. While depressing the sensor door, lift the ice maker service door and remove the ice from the ejector with a plastic utensil. See the “Ice Maker and Storage Bin/Bucket” section.
- **Has a large amount of ice just been removed?** Allow 24 hours for ice maker to produce more ice.
- **Are the controls set correctly?** See the “Setting or Using the Controls” section.
- **Is there a water filter installed on the refrigerator?** The filter may be clogged or installed incorrectly. Check the filter installation instructions to ensure that the filter was installed correctly and is not clogged. If installation or clogging is not a problem, call a technician or other qualified person.

NOTE: If not due to any of the above, there may be a problem with the water line. Call for service.

Off-taste, odor or gray color in the ice

- **Are the plumbing connections new, causing discolored or off-flavored ice?** Discard the first few batches of ice.
- **Have the ice cubes been stored too long?** Throw old ice away and make a new supply.
- **Does the freezer and ice bin or bucket need to be cleaned?** See the “Cleaning” or “Ice Maker and Storage Bin/Bucket” section.
- **Has food in the freezer or refrigerator been wrapped properly?** Use airtight, moisture-proof packaging to help prevent odor transfer to stored food.
- **Does the water contain minerals (such as sulfur)?** A filter may need to be installed to remove the minerals.
- **Is there a water filter installed on the refrigerator?** Gray or dark discoloration in ice indicates that the water filtration system needs additional flushing. Run additional water through the water dispenser to flush the water filtration system more thoroughly (at least 2 to 3 gal. [8 to 12 L] or 6 to 7 minutes initially). Discard discolored ice.

The ice dispenser will not operate properly

- **Is the freezer door closed completely?** Push the door firmly shut. If it will not shut all the way, see “The doors will not close completely” later in this section.
- **Is the ice bin or bucket installed correctly?** For models with an interior ice bin, push the ice bin in all the way. If the ice bin does not go in all the way, it may not be put in straight. Pull it out and try again. For models with an ice bucket located on the freezer door, the bucket should sit level. To remove the bucket, press the release button on the right side of the bucket and lift straight up. Replace the bucket in the door making sure it is properly aligned and snapped securely into place. Refer to the “Ice Maker and Storage Bin/Bucket” section.
- **Has the wrong ice been added to the bin or bucket?** Use only cubes produced by the current ice maker. If other cubes have been added, remove all cubes and check to see that none have become stuck in the delivery chute.
- **Has the ice frozen in the ice bin or bucket?** Shake the ice bin or bucket to separate cubes. If cubes do not separate, empty bin or bucket and wait 24 hours for ice to restock.
- **Has the ice melted around the auger (metal spiral) in the ice bucket?** Dump the ice cubes and clean the ice bucket completely. Allow 24 hours for the ice maker to restock. Do not try to remove the melted ice with a sharp object. You could damage the ice bucket.
- **Is ice stuck in the delivery chute?** Clear the ice from the delivery chute with a plastic utensil. Do not use anything sharp to remove the ice. You could cause damage.
- **Is the ice dispenser stalling while dispensing “crushed” ice?** Stop dispensing ice. Change the ice button from “crushed” to “cubed.” Depress the ice dispenser arm using a sturdy glass. If cubed ice dispenses correctly, depress the button for “crushed” ice and begin dispensing again. Refer to the “Water and Ice Dispensers” section.
- **Is there ice in the bucket?** See “The ice maker is not producing ice” earlier in this section.
- **Has the dispenser arm been held in too long?** Release dispenser arm. Ice will stop dispensing when the arm is held in too long. Wait three minutes for dispenser motor to reset before using again. It is best to take large amounts of ice directly from the ice bin or bucket, not through the dispenser.

Ice bucket difficult to remove

- **Is the ice bucket difficult to remove (on some models)?** For models with an ice bucket located on the freezer door, select “cubed” ice. Using a sturdy glass, quickly depress and release the ice dispenser arm. Open the freezer door, depress the release button on the ice bucket and lift upward. Refer to the “Ice Maker and Storage Bin/Bucket” section.

The water dispenser will not operate properly

- **Has the water system not filled?** The water system needs to be filled the first time it is used. Use a sturdy container to depress the water dispenser bar until the water begins to flow. Flush the water system by dispensing and discarding 2 to 3 gal. (8 to 12 L) of water. Cleaning the system will take approximately 6 to 7 minutes and will help clear air from the line. Additional flushing may be required in some households. See the “Water and Ice Dispensers” section.
- **Is the water shutoff valve not turned on or the water line connected at the source?** Make sure the water shutoff valve is turned on and the water source is connected to the refrigerator. See the “Water Supply Connection” section.
- **Is the water shutoff valve clogged or incorrectly installed?** See the “Water Supply Connection” section. If clogging or installation is not a problem, call for service or contact a plumber.
- **Is there a kink in the home water source line?** If you find or suspect a kink in the water line, call for service.
- **Is there a water filter installed on the refrigerator?** The filter may be clogged or incorrectly installed. First, check the filter installation instructions to ensure that the filter was installed correctly and is not clogged. If installation or clogging is not a problem, call for service.

Water or ice is leaking from the dispenser

- **Is the glass not being held under the ice dispenser long enough, causing the ice to spill?** Hold the container under the ice chute for two to three seconds after releasing the dispenser lever. Water or ice may continue to dispense during this time.
- **Is an ice cube stuck in the chute and holding the trap door open?** Remove the cube.
- **Is there a water filter installed on the refrigerator?** The water filtration system may have air in the lines, causing water to drip. Additional flushing may help clear air from the lines. Normal dispenser use should flush air from the lines within 24 to 72 hours.

Water flow from the dispenser decreases noticeably

- **Is there a water filter installed on the refrigerator?** The filter may be full or incorrectly installed. Remove the water filter cartridge (see the “Water Filtration System” section). Operate the dispenser. If the water flow increases noticeably, replace the filter.

The dispenser water is not cool enough

- **Has the refrigerator been newly installed?** Allow 24 hours for the refrigerator to cool completely.
- **Has a large amount of water been recently dispensed?** Allow 24 hours for the water to cool completely.
- **Has water not been recently dispensed?** The first glass of water may not be cool. Discard the first glass of water.

The divider between the two compartments is warm

The warmth is probably due to normal operation of the automatic exterior moisture control. If still concerned, call for service.

Temperature is too warm

- **Are the air vents blocked in either compartment?** This prevents the movement of cold air from the freezer to the refrigerator. Remove any objects from in front of the air vents. See the “Ensuring Proper Air Circulation” section for the location of air vents.
- **Are the door(s) opened often?** The refrigerator will warm when this occurs. Keep the refrigerator cool by getting all items out at one time, keeping food organized, and closing the door as soon as possible.
- **Has a large amount of food just been added to the refrigerator or freezer?** Adding a large amount of food warms the refrigerator. It can take several hours for the refrigerator to return to the normal temperature.
- **Are the controls set correctly for the surrounding conditions?** See the “Setting or Using the Controls” section.
- **Is the refrigerator not cooling?** For models with digital controls, turn the unit OFF then ON again to reset. See the “Setting or Using the Controls” section. If this does not correct the problem, call for service.

There is interior moisture buildup

- **Are the air vents blocked in the refrigerator?** Remove any objects from in front of the air vents. See the “Ensuring Proper Air Circulation” section for the location of air vents.
- **Are the door(s) opened often?** Avoid humidity buildup by getting all items out at one time, keeping food organized, and closing the door as soon as possible.
- **Is the room humid?** It is normal for moisture to build up inside the refrigerator when the room air is humid.
- **Is the food packaged correctly?** Check that all food is securely wrapped. Wipe off damp food containers before placing in the refrigerator.
- **Are the controls set correctly for the surrounding conditions?** See the “Setting or Using the Controls” section.
- **Was a self-defrost cycle completed?** It is normal for droplets to form after the refrigerator self-defrosts.

The doors will not close completely

- **Are food packages blocking the door open?** Rearrange containers so that they fit more tightly and take up less space.
- **Is the ice bin or ice bucket out of position?** For models with an interior ice bin, push the ice bin in all the way. If the ice bin does not go in all the way, it may not be put in straight. Pull it out and try again. For models with an ice bucket located on the freezer door, the bucket should sit level. To remove the bucket, press the release button on the right side of the bucket and lift straight up. Replace the bucket in the door making sure it is properly aligned and snapped securely into place. See the “Ice Maker and Storage Bin/Bucket” section.
- **Are the pans, shelves, bins, or baskets out of position?** Put the crisper cover and all pans, shelves, bins, and baskets back into their correct positions. See the “Crisper and Crisper Covers” section for more information.
- **Are the gaskets sticking?** Clean gaskets according to the directions in the “Cleaning” section.
- **Does the refrigerator wobble or seem unstable?** Level the refrigerator. See the “Door Closing” or “Leveling Refrigerator” section, depending on your model.
- **Were the doors removed during product installation and not properly replaced?** Remove and replace the doors according to the “Door Removal” section on some models, or call a qualified service technician.

The doors are difficult to open

- **Are the gaskets dirty or sticky?** Clean gaskets according to the directions in the “Cleaning” section.

Computer Troubleshooting (on some models)

See the “Computer and Software User Guide” for information regarding your computer system.

ASSISTANCE OR SERVICE

Before calling for assistance or service, please check “Troubleshooting.” It may save you the cost of a service call. If you still need help, follow the instructions below.

When calling, please know the purchase date and the complete model and serial number of your appliance. This information will help us to better respond to your request.

If you need replacement parts

If you need to order replacement parts, contact the dealer from whom you purchased the unit or a Whirlpool designated service company.

Accessories

Replacement filters

To order accessories, contact your authorized Whirlpool dealer and ask for the appropriate part number listed below.

Stainless Steel Cleaner & Polish

Order Part #4396095

Cabinet Side Trim kits:

Part #2208187S - Stainless Trim Kit
Part #2208187W - White Trim Kit
Part #2208187B - Black Trim Kit
Part #2208187T - Biscuit Trim Kit

Decorative Door Panel kits:

Part #4378123 - White Cabinet Color
Part #4378124 - Black Cabinet Color
Part #4378125 - Biscuit Cabinet Color

Base grille water filter cartridges:

NOTE: Do not use with water that is microbiologically unsafe or of unknown quality without adequate disinfection before or after the system.

Standard Cartridge:

Order Part #4392857 (NL300 and L500)

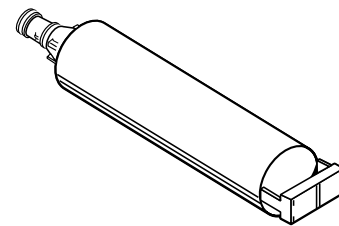

WHIRLPOOL® REFRIGERATOR WARRANTY

ONE-YEAR FULL WARRANTY ON REFRIGERATOR

For one year from the date of purchase, when this refrigerator is operated and maintained according to instructions attached to or furnished with the product, Whirlpool Corporation will pay for factory specified replacement parts and repair labor to correct defects in materials or workmanship. Service must be provided by a Whirlpool designated service company.

FIVE-YEAR FULL WARRANTY ON SEALED REFRIGERATION SYSTEM AS PARTS LISTED

For five years from the date of purchase, when this refrigerator is operated and maintained according to instructions attached to or furnished with the product, Whirlpool Corporation will pay for factory specified replacement parts and repair labor to correct defects in materials or workmanship in the sealed refrigeration system. These parts are: compressor, evaporator, condenser, dryer, connecting tubing. Service must be provided by a Whirlpool designated service company.

Whirlpool Corporation will not pay for:

1. Service calls to correct the installation of your refrigerator, to instruct you how to use your refrigerator, to replace house fuses or correct house wiring or plumbing or to replace light bulbs.
 2. Repairs when your refrigerator is used in other than normal, single-family household use.
 3. Pickup and delivery, your refrigerator is designed to be repaired in the home.
 4. Damage to your refrigerator caused by accident, misuse, fire, flood, improper installation, acts of God, or use of products not approved by Whirlpool Corporation.
 5. Any food loss due to product failure.
 6. Repairs to parts or systems resulting from unauthorized modifications made to the appliance.
 7. Replacement parts or repair labor costs for units operated outside the United States and Canada.
-

WHIRLPOOL CORPORATION SHALL NOT BE LIABLE FOR INCIDENTAL OR CONSEQUENTIAL DAMAGES

Outside the United States, a different warranty may apply. For details, please contact your authorized Whirlpool dealer.

If you need service, first see the "Troubleshooting" section of this book. After checking "Troubleshooting," additional help can be found by checking the "Assistance or Service" section.

For warranty information in Australia and New Zealand:

Please fill out the Product Registration Card and drop it in a post box. No stamp is required.

Specific warranty details are outlined in this booklet. However, the benefits conferred by this express warranty are additional to all other conditions, warranties, guarantees, rights or remedies expressed or implied by the Trade Practices Act and similar State or Territory laws and all other obligations and liabilities on the part of the manufacturer or supplier and nothing contained herein shall restrict or modify such rights, remedies, obligations, or liabilities.

Should you require any assistance or service, phone the Whirlpool Customer Service Centre in Australia at **1800 032 103** and New Zealand **0800 44 2584** (toll free).

Keep this book and your sales slip together for future reference. You must provide proof of purchase or installation date for in-warranty service.

Write down the following information about your refrigerator to better help you obtain assistance or service if you ever need it. You will need to know your complete model number and serial number. You can find this information on the model and serial number label, located on your appliance as shown in the "Parts and Features" section of this book.

Dealer name _____
Address _____
Phone number _____
Model number _____
Serial number _____
Purchase date _____

2254913

© 2002 Whirlpool Corporation.
All rights reserved.

© Registered Trademark/TM Trademark of Whirlpool, U.S.A.



9/02
Printed in U.S.A.

Free Manuals Download Website

<http://myh66.com>

<http://usermanuals.us>

<http://www.somanuals.com>

<http://www.4manuals.cc>

<http://www.manual-lib.com>

<http://www.404manual.com>

<http://www.luxmanual.com>

<http://aubethermostatmanual.com>

Golf course search by state

<http://golfingnear.com>

Email search by domain

<http://emailbydomain.com>

Auto manuals search

<http://auto.somanuals.com>

TV manuals search

<http://tv.somanuals.com>