

VENTED KITCHEN RANGE HOOD FOR 120 V. OPERATION



KITCHEN RANGE HOOD MODEL

RH4930XL

INSTALLATION INSTRUCTIONS

READ AND SAVE THESE INSTRUCTIONS

Before you begin, read the following instructions completely and carefully. If followed, they will simplify the installation job.

IMPORTANT: OBSERVE ALL GOVERNING CODES AND ORDINANCES

SAVE THESE INSTRUCTIONS FOR THE LOCAL ELECTRICAL INSPECTOR'S USE

Your range hood has been designed to filter out smoke odors and grease which rise from the cooking surface. Before you begin the installation be sure that all parts and accessories are removed from carton. For best results and ease in the installation of this range hood, read the instructions sheet to become familiar with the step by step installation.

YOUR HOOD CAN BE INSTALLED VENTLESS WHERE AIR IS CIRCULATED BACK INTO THE ROOM THROUGH THE FILTER OR VENTED WHERE AIR IS TAKEN OUT OF YOUR KITCHEN.

For most efficient operation, the top of the hood should be approximately 66 inches (167.6 cm) from the floor. See Page 2 for examples of typical ductwork installations. Choose the best method for your installation.

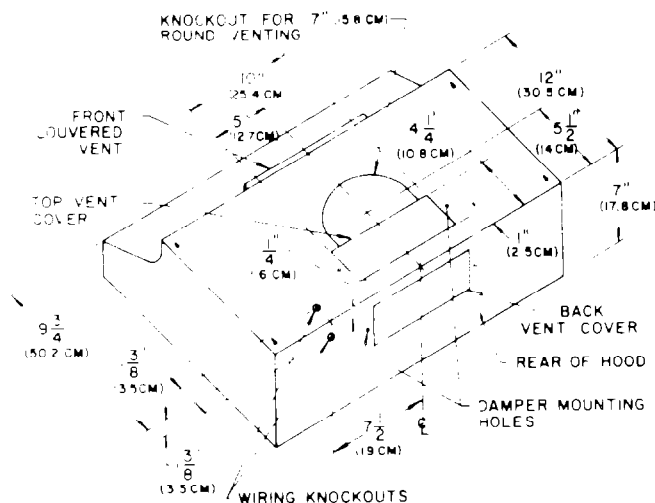

FIG. 1

TOOLS AND MATERIALS REQUIRED

	<ul style="list-style-type: none"> • Drill, electric or ratchet drive, with 1-1/4" wood bit (to drill an access hole in the cabinet or kitchen wall for the electric power line.) • One common head screwdriver (to secure hood mounting screws to the cabinet and hood sheet metal parts) • Pliers (for opening knockouts) • Pencil, ruler and level for marking cabinet locations • Saber saw or keyhole saw for cutting the wall or cabinet openings • Caulking, metal snips, duct tape, ducts (with elbow and transition, if necessary) and wall cap or roof cap, as required 	
--	---	--

1. For vented applications, see Figures 3, 4, and 5. Typical vented installations are shown for the 7" Round Vertical, 3" x 10" Vertical, and the 3" x 10" Horizontal Discharge respectively. Choose the best method for your installation.

2. Mark locations on cabinet or wall for ventilating duct and electrical wiring from dimensions given in Figure 1.

3. Cut holes at marked locations to accommodate ventilating duct and electrical wiring. Allow 1" (1.91 cm) extra on ventilating opening toward the front of cabinet directly above the hood. Be sure to minimize openings through outside walls or the ceiling. These will have to be sealed later.

4. Run wire through wall or cabinets according to the National Electrical Code and applicable local codes. **DO NOT** turn power on until installation is complete.

5. Remove screws holding junction box cover. See Figure 7.

6. Lift the hood into position and mark the hole locations on the cabinet for each of the four keyhole mounting slots.

7. Remove the hood and start all four screws in the center of the narrow neck of the keyhole slot marked on the cabinet bottom. See Figure 2.

8. Remove proper venting knockout. If 7" (17.8 cm) round vertical venting, entire top knockout including rectangular portion must be removed. The best performance from your hood, with most air taken from the kitchen and when the hood is most quiet, comes when you top vent with 7" round duct pipe as shown in Figure 3.

9. Install proper ductwork. For round vented installations, a round damper should be placed in the ductwork to prevent air infiltration.

10. Lift the hood into position simultaneously feeding the electrical wire through the knockout.

11. Tighten four mounting screws to secure hood to cabinet. Be sure the screw heads are in the narrow neck of the keyhole slot.

12. Complete electrical wiring in the junction box according to the National Electrical Code and applicable local codes.

NOTE: This unit must be permanently grounded.

13. Replace junction box cover.

14. Seal holes around ventilating pipe and wiring passing through ceiling or outside wall with caulking or insulation to prevent heat loss.

15. Be sure that damper which is supplied with this model is properly installed. (See Figures 3, 4, and 5.)

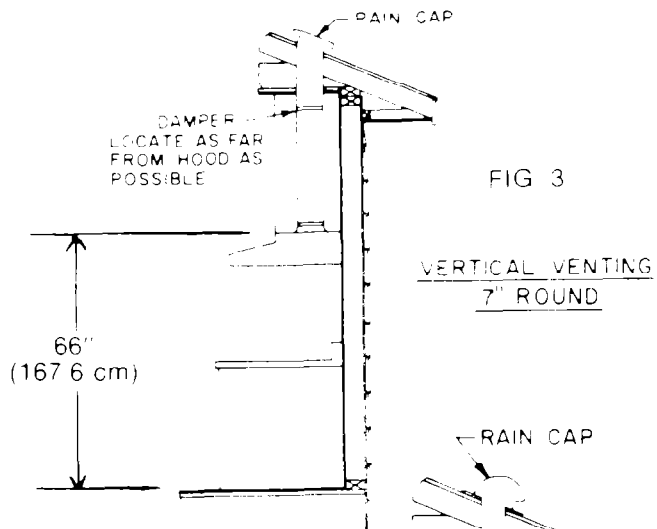

—KEYHOLE SLOT IN CANOPY

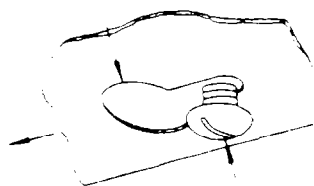

SCREW
(IN INSTALLATION PARTS BAG)

FIG 2

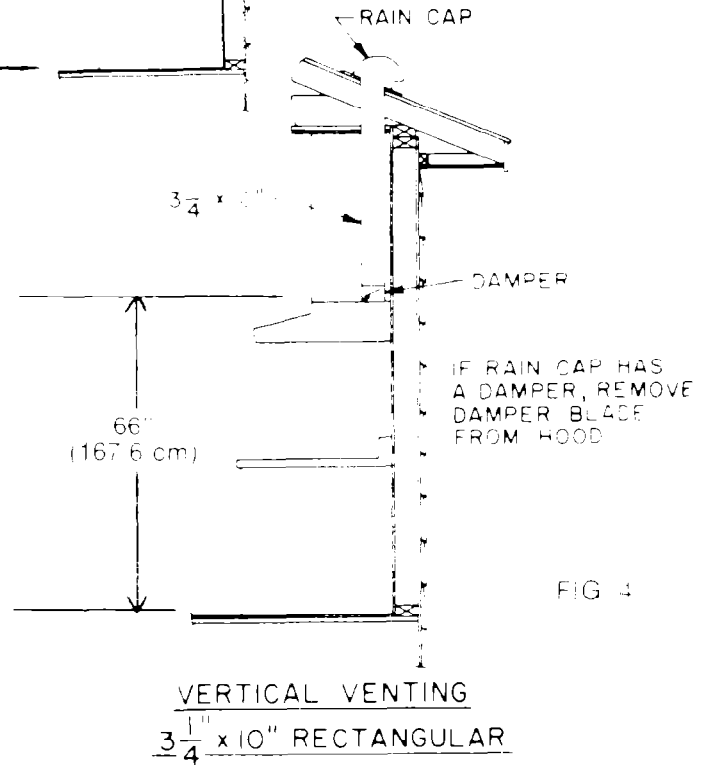

FIG 4

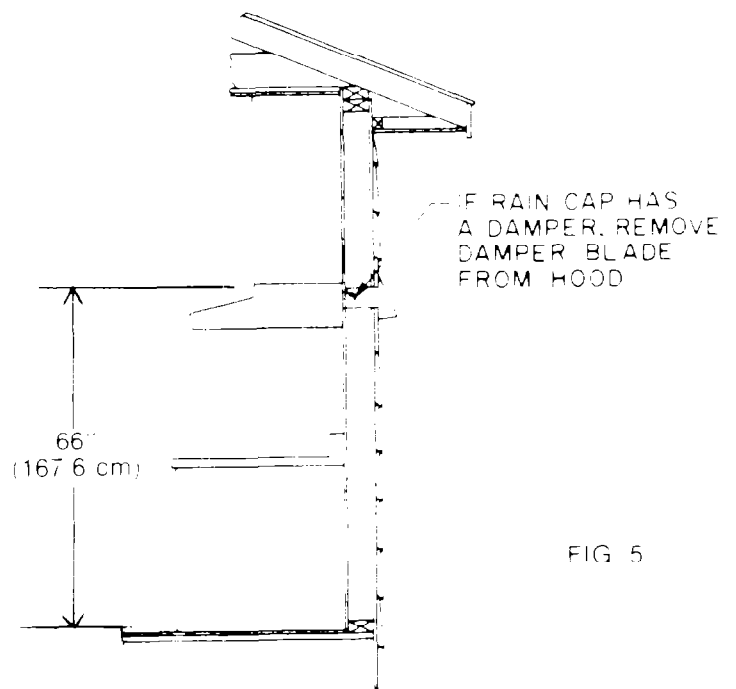

FIG 5

NOTE:

- A For round vertical venting, remove the entire top knock-out including the rectangular portion
- B For rectangular vertical venting, remove the 3 1/2 x 10 rectangular knockout only

FOR VENTLESS INSTALLATION

1. To convert your range hood to ventless, remove the discharge grill shown in Figure 6 by pulling with fingers. Remove the metal back seal from behind the louver.
2. Replace discharge grill and secure with plastic rivets by pushing with thumb.
3. Follow instructions under "Vented Installations" for wiring the mounting. Omit ductwork preparations.
4. Install charcoal filter from ventless kit **behind aluminum filter.** (See Figure 7).

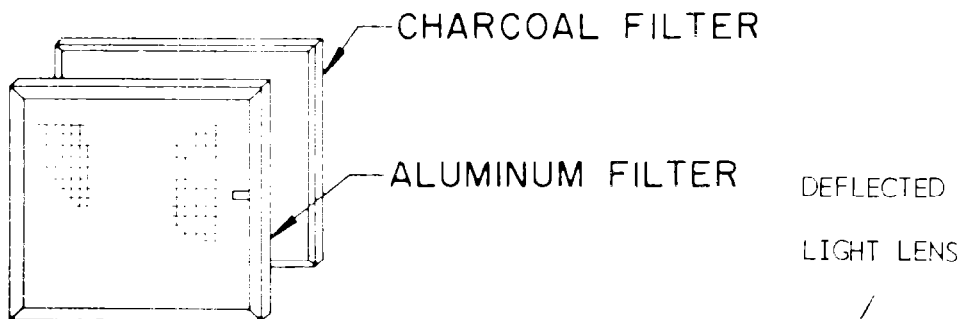
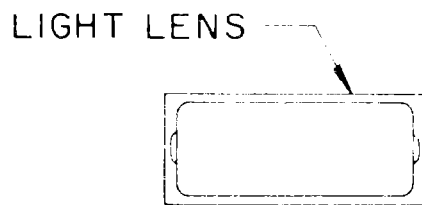
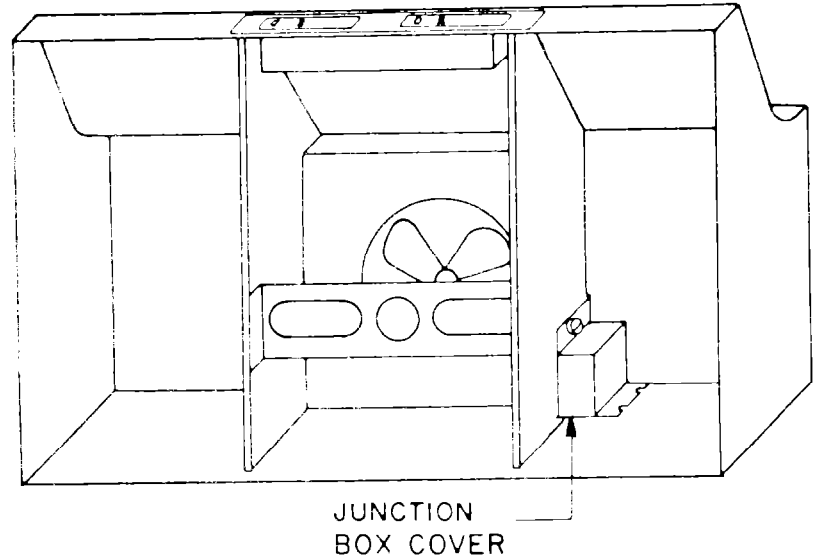
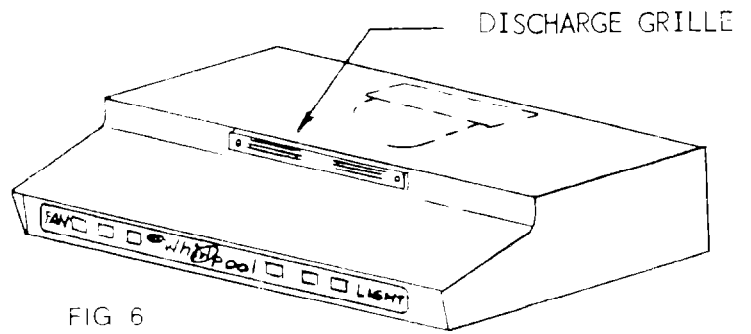

LIGHT LENS REMOVAL AND INSTALLATION

REMOVAL

1. Remove the filter, exposing the light lens (Figure 8).
2. Grasp the lens in the center with both hands and bend downward.
3. The light lens can now be deflected and pulled out from the range hood.

INSTALLATION

1. Deflect the lens (Step 2 above) placing the lower side flanges above the grease trap flanges.
2. Release the light lens allowing it to snap back into position.
3. Slide light lens to front of hood.
4. Replace filter.

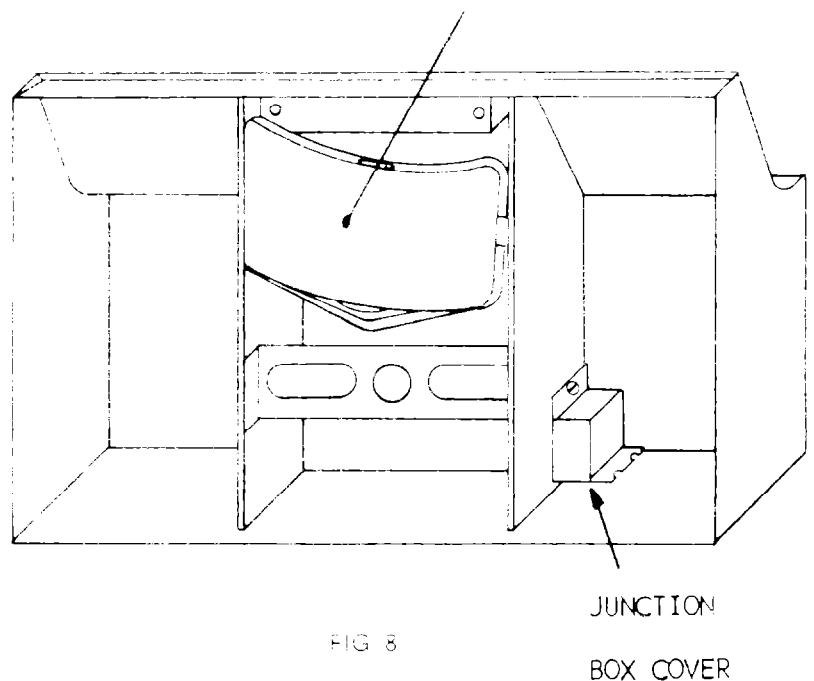

OPERATION AND CARE OF UNIT

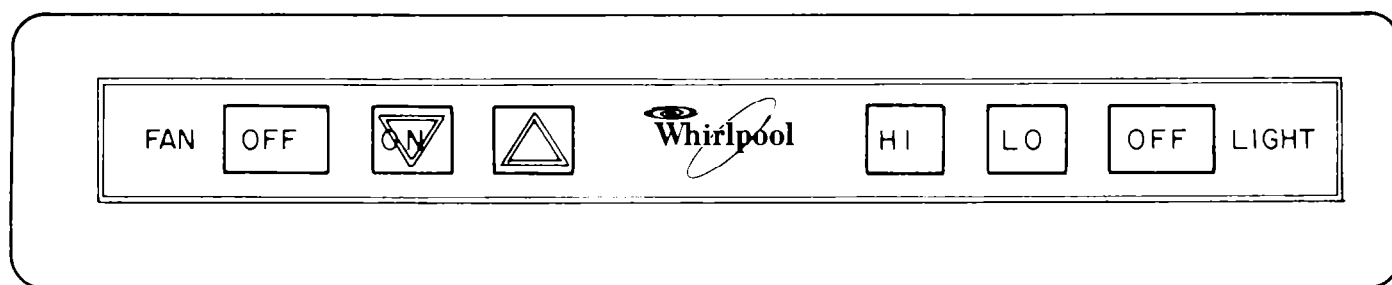

FAN AND LIGHT CONTROL PANEL

FAN:

For best results, turn the fan on at the beginning of cooking and allow it to run until all smoke and odors are removed from the room.

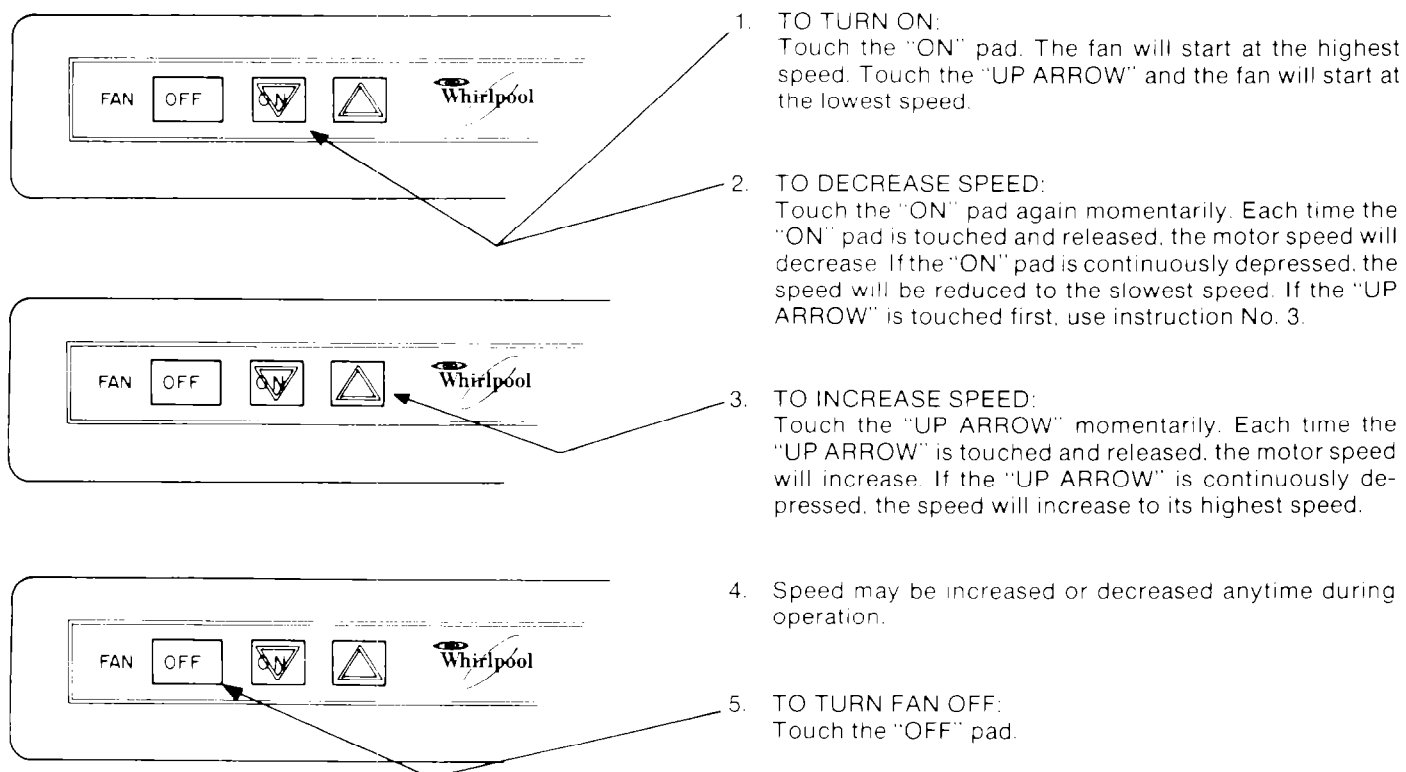

LIGHT:

Do not use bulb larger than 60 Watts.

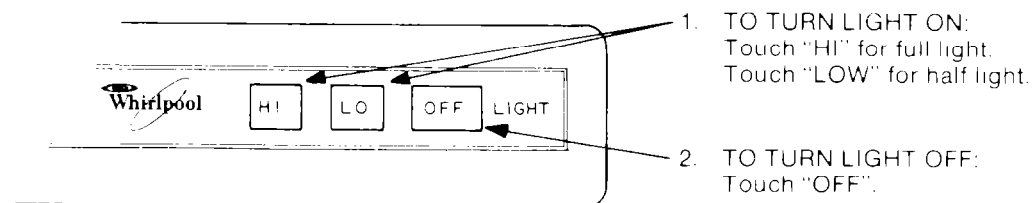

FILTER:

For best results, remove and clean often. The filter may be placed in the dishwasher or washed in hot sudsy water.

EXTERIOR SURFACES:

Clean the range hood with a mild detergent and soft cloth. Do not use abrasive cleansers or soapy steel wool pads.

OPERATING CHARACTERISTICS

If a power outage occurs, the following things may happen when power is restored:

1. The fan may come on.
2. The light may come on.
3. Both may come on.
4. Nothing will happen and the unit may be operated normally.

These conditions are normal for this type of digital electronic circuitry. When power is first applied to digital circuitry, it comes up at random either in the high mode or low mode. In the low mode nothing is energized but if it comes up in the high mode either the fan and/or the light will be energized.

Touching the OFF pads will reset the circuitry and allow normal operation of the unit.

To eliminate the possibility of the fan or light coming on due to a power outage and restoration during an extended absence from the home, power to the unit may be shut off at the breaker box.

If you need service or assistance, we suggest you follow these four steps:

1. Before calling for assistance...

Performance problems often result from little things you can find and fix yourself without tools.

If nothing operates:

- Have you checked the main fuse or circuit breaker box?

2. If you need assistance...

Call the Whirlpool COOL-LINE® service assistance telephone number. Dial free from:

Continental U.S.	(800) 253-1301
Michigan	(800) 632-2243
Alaska & Hawaii	(800) 253-1121

and talk with one of our trained Consultants. The Consultant can instruct you in how to obtain satisfactory operation from your appliance or, if service is necessary, recommend a qualified service company in your area.



3. If you need service...



Whirlpool has a nationwide network of franchised TECH-CARE® Service Companies. TECH-CARE service technicians are trained to fulfill the product warranty and provide after-

warranty service anywhere in the United States. To locate TECH-CARE service in your area, call our COOL-LINE service assistance telephone number (see Step 2) or look in your telephone directory Yellow Pages under

APPLIANCES—HOUSEHOLD
MAJOR—SERVICE & REPAIR

ELECTRICAL APPLIANCES—
MAJOR—REPAIRING & PARTS

WHIRLPOOL APPLIANCES
FRANCHISED TECH-CARE SERVICE
SERVICE COMPANIES
XYZ SERVICE CO.
123 Main St.
999-9999

OR

WHIRLPOOL APPLIANCES
FRANCHISED TECH-CARE SERVICE
SERVICE COMPANIES
XYZ SERVICE CO.
123 Main St.
999-9999

OR

WASHING MACHINES, DRYERS
& IRONERS—SERVICING

WHIRLPOOL APPLIANCES
FRANCHISED TECH-CARE SERVICE
SERVICE COMPANIES
XYZ SERVICE CO.
123 Main St.
999-9999

4. If you have a problem...

Call our COOL-LINE service assistance telephone number (see Step 2) and talk with one of our Consultants, or if you prefer, write to:

Mr. Jack Sparks, Vice President
Whirlpool Corporation
Administrative Center
2000 US-33 North
Benton Harbor, MI 49022

If you must call or write, please provide model number, serial number, date of purchase, and a complete description of the problem. This information is needed in order to better respond to your request for assistance.

Free Manuals Download Website

<http://myh66.com>

<http://usermanuals.us>

<http://www.somanuals.com>

<http://www.4manuals.cc>

<http://www.manual-lib.com>

<http://www.404manual.com>

<http://www.luxmanual.com>

<http://aubethermostatmanual.com>

Golf course search by state

<http://golfingnear.com>

Email search by domain

<http://emailbydomain.com>

Auto manuals search

<http://auto.somanuals.com>

TV manuals search

<http://tv.somanuals.com>