

# Installation Instructions

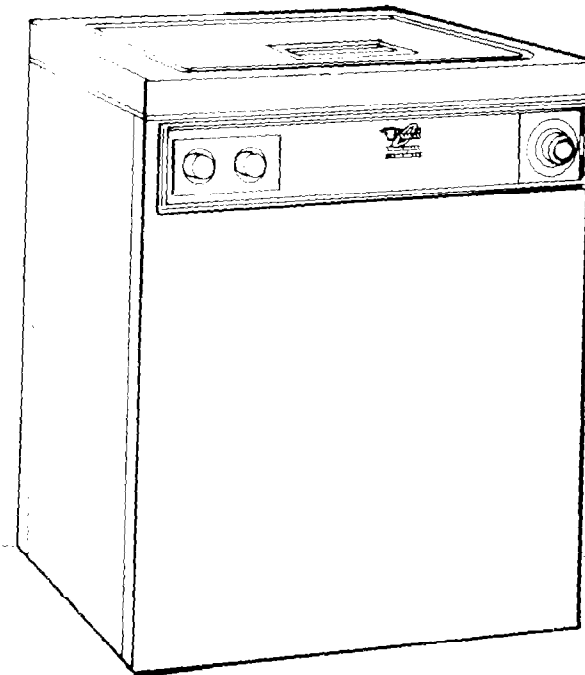

Part No. 3347020

## IMPORTANT

**Installer:** Leave Installation Instructions with the homeowner.

**Homeowner:** Keep Installation Instructions for future reference.

**Save** Installation Instructions for local electrical inspector's use.

## Convertible Compact Washer



## Before you start...

Check location where washer will be used. Proper installation for operation is your responsibility. Make sure you have everything necessary for correct operation.

Untape and open washer lid. Remove packages from washer. Do not remove combination hose or release shipping straps at this time. Close and retape lid.

**Hot and cold single-spout water faucet:** Must be accessible within 4 feet of back of washer and provide 5-100 PSI water pressure.

**Water Heater:** Set to deliver 140° F water to washer.

**Protection from weather:** Do not store or operate washer below 32° F. See Use and Care Guide for further information.

**Sink or laundry tub:** with minimum carry-away capacity of 7 gallons per minute to drain washer. Top of sink or tub must be at least 27 inches high and no higher than 48 inches from bottom of washer.

**Support:** Floor must be sturdy enough to support washer weight of 250 pounds.

**Important:** Observe all governing codes and ordinances.

**Level floor:** maximum floor slope under entire washer 1/8-inch

**SEE RECESSED AREA INSTRUCTIONS ON BACK COVER.**

## Tools needed for installation:

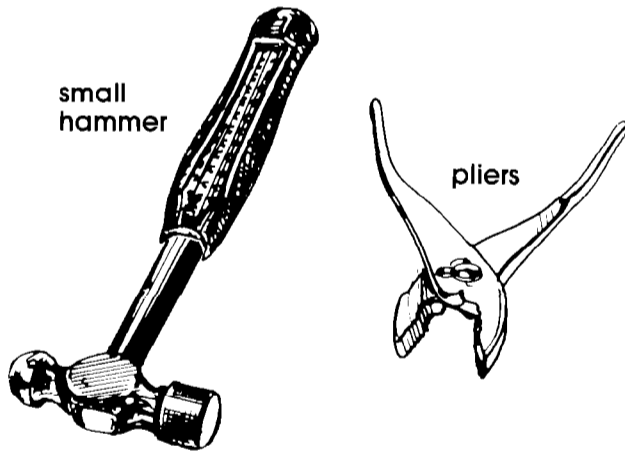

small hammer

pliers

## Parts supplied for installation:

Remove parts from packages. Check that all parts were included.

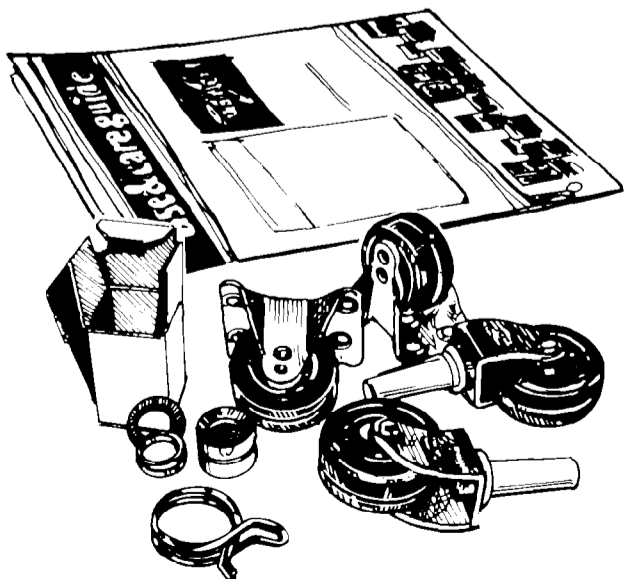

- 1 literature package
- 2 front casters
- 2 rear casters
- 1 hose clamp
- 1 faucet adapter kit

## Electrical requirements

120 volt, 60 Hz, AC only, 15 or 20 ampere fused electrical supply is required. (Time-delay fuse or circuit breaker is recommended.) It is recommended that a separate circuit serving only this appliance be provided.

receptacle is not available, it is the personal responsibility and obligation of the customer to have a properly grounded 3-prong wall receptacle installed by a qualified electrician.

### WARNING:

#### Electrical Shock Hazard

- Check with a qualified electrician if you are in doubt as to whether the appliance is properly grounded. Do Not modify the power supply cord plug – if it will not fit the outlet, have a proper outlet installed by a qualified electrician. Improper connection of the equipment-grounding conductor can result in a risk of electrical shock.
- Do Not use an extension cord with this appliance. Such use may result in a fire, electrical shock or other personal injury.
- Do Not have a fuse in the neutral or grounding circuit. This could result in a risk of electrical shock.

## Recommended grounding method

**Do Not, under any circumstances, remove the power supply cord grounding prong.**

For your personal safety, this appliance must be grounded. This appliance is equipped with a power supply cord having a 3-prong grounding plug. To minimize possible shock hazard, the cord must be plugged into a mating 3-prong grounding type wall receptacle, grounded in accordance with National Electrical Code, ANSI/NFPA 70-1987 (or to the latest) and local codes and ordinances. See Figure 1. If a mating wall

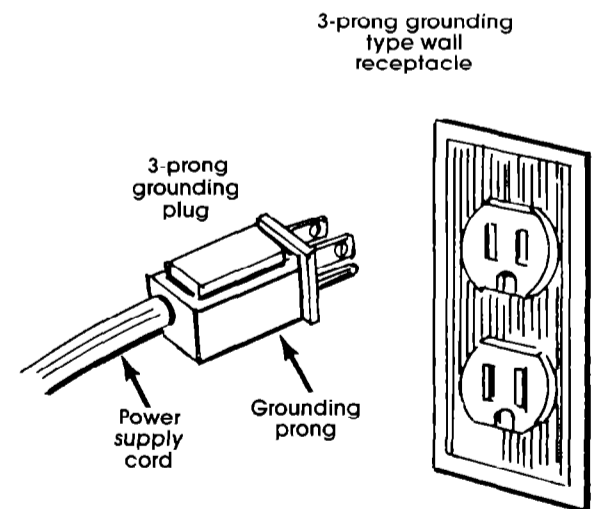

Figure 1

## Now start...

With washer in laundry area.



**1.**

Place two foam corners from the carton on the floor to the right side of the washer.

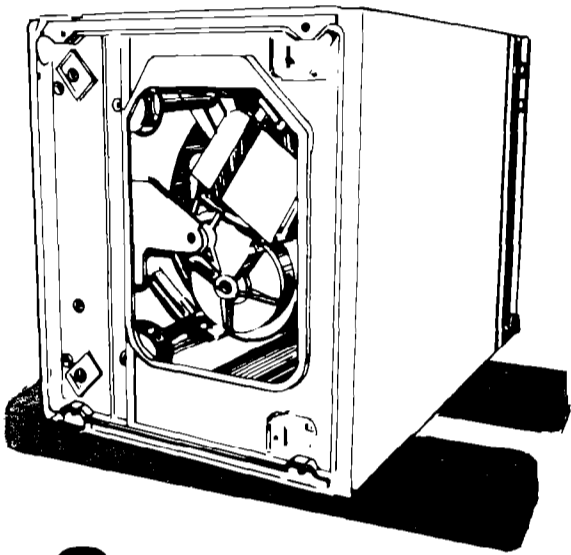

**2.**

Stand in front of washer. Firmly grasp washer and gently lay it right side down on foam corners.

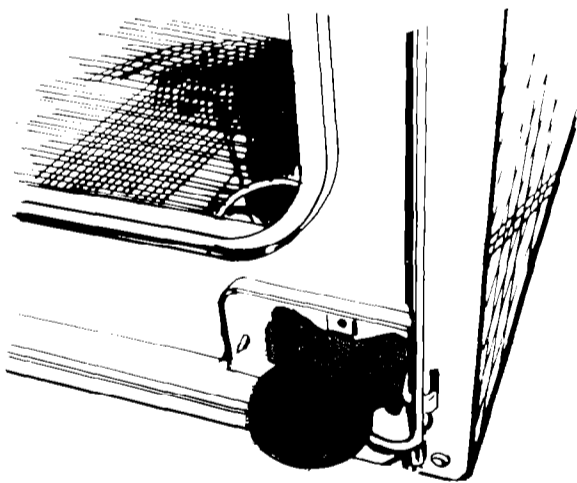

**3.**

Slide front casters into slots at front corners of washer. Lightly tap casters with small hammer until they lock in place.

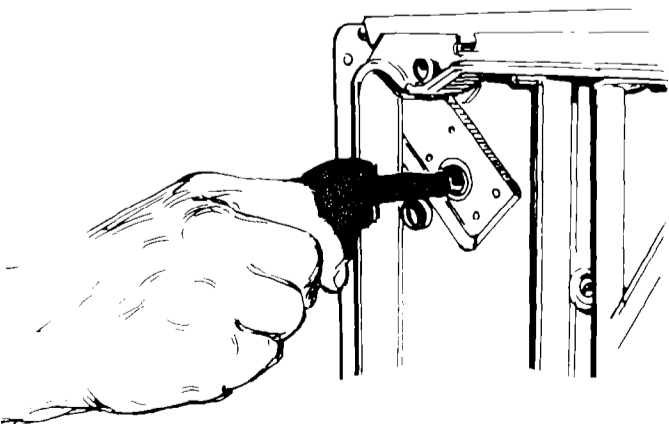

**4.**

Firmly push rear casters into holes at rear corners of washer. Lightly tap casters with small hammer until they lock in place. Check front and rear casters again. If casters are not locked in place, they may fall out when washer is moved or cause the washer to vibrate during use.

**5.**

Now stand the washer back up.

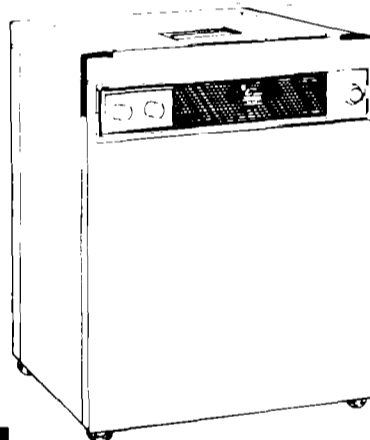

Read yellow card

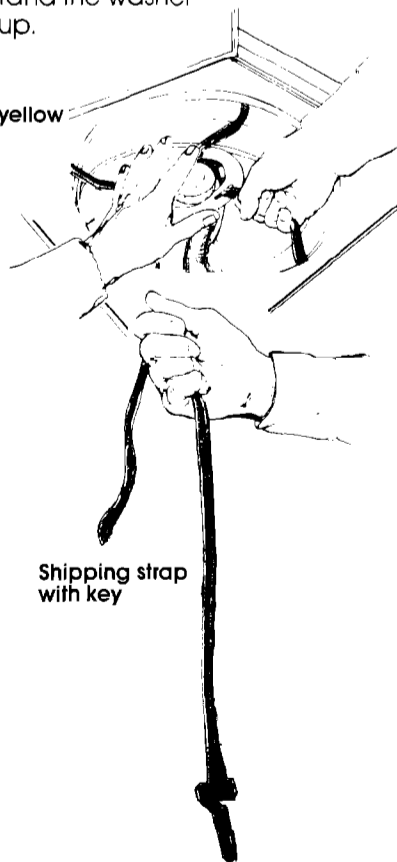

Shipping strap with key

**6.**

Untape and open washer lid. Read yellow card. Place hand on top of agitator when removing shipping straps. Firmly jerk then pull the three (3) shipping straps completely out of the washer, one at a time. Put straps close to your tools. Remove yellow tape from the top front corners.

**7.**

Remove yellow card. Take combination hose out of basket.

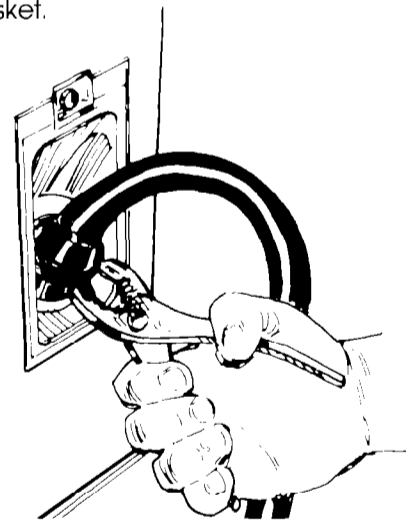

**8.**

Place hose clamp over washer drain connector. Push drain hose down over washer drain connector. Use pliers to open clamp and slide clamp up over drain hose and connector. Release clamp and check for good fit. DO NOT KINK OR TWIST HOSES.

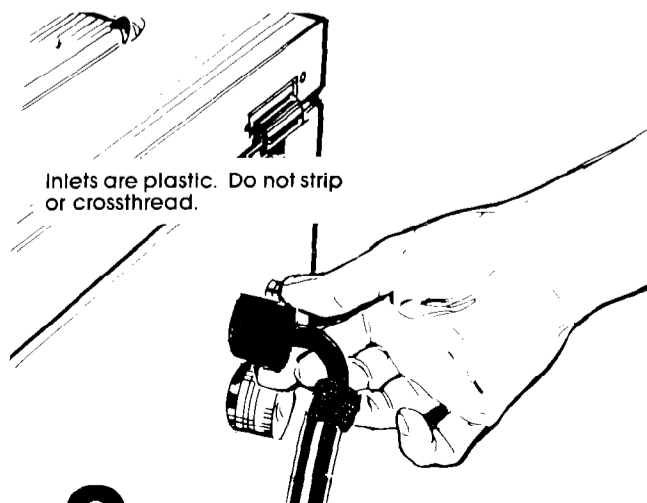

**9.**

Attach inlet hose to top inlet valve opening. Tighten coupling by hand. Use pliers to make an additional two-thirds turn.

Remove screen holder or aerator from end of faucet. For faucets with external threads, screw adapter directly onto faucet end.

If faucet has internal threads, first install washer and threaded bushing, then adapter screws onto the bushing. For other faucet types, see your Whirlpool dealer for a special adapter kit.

**Note:** If washer will be used at a faucet equipped with a spray hose attachment, constant pressure may cause the spray hose to leak. To prevent potential problems, permanently disconnect the spray hose or replace with a high pressure hose.

**12.** CHECK THE ELECTRICAL REQUIREMENTS TO BE SURE YOU HAVE THE CORRECT ELECTRICAL SUPPLY AND RECOMMENDED GROUNDING METHOD. Check the Installation Instructions to see that you have completed each step. If you have skipped a step, go back and complete that step before you continue with the following steps.

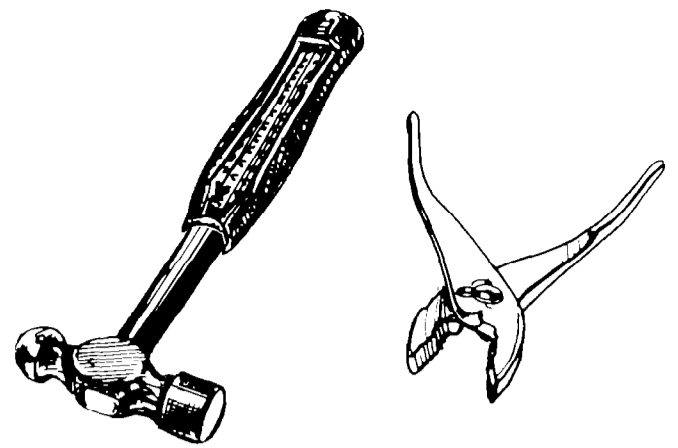

**17.** Check that you have all the tools that you started with and that you have removed the three shipping straps with keys from the washer.

**18.** Unwind electrical cord and plug into grounded outlet.

**19.** Now start the washer and allow it to complete the regular cycle.

**20.** When cycle is completed, unplug electrical cord, then turn water "OFF." Press the red bleeder button on the connector to release water pressure. With one hand move the locking collar downward while using the other hand to pull down on the connector. Turn water connector upside down to empty remaining water.

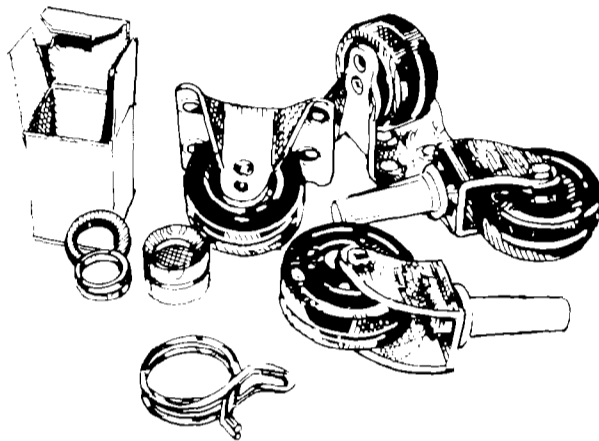

**13.** Check that all parts are now installed. See parts list, Panel A. If there is an extra part, go back through the steps to see which step was skipped.

**14.** Read the Use and Care Guide, so you can get the best use from your new washer. Move the washer to the location where it will be used.

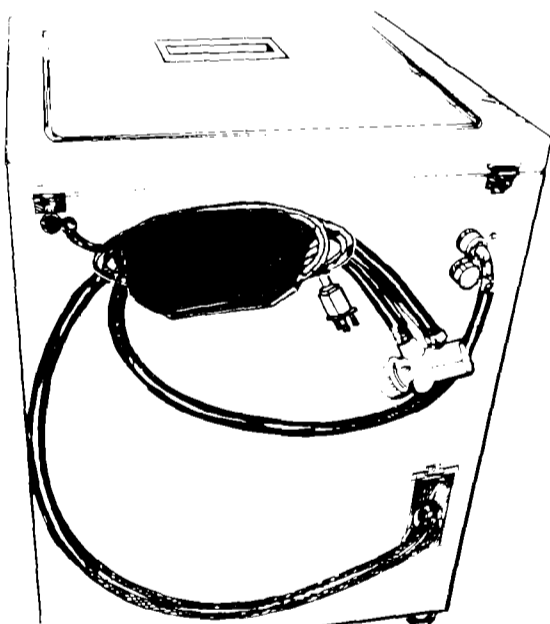

**10.** For storage, wrap the combination hose and power supply cord around bracket.

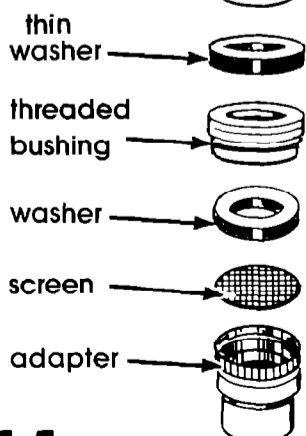

**11.** Use the faucet adapter kit that came with your washer to modify the faucet where washer will be used. (If you have a Whirlpool portable dishwasher, you do not need to modify your faucet. The same adapter can be used.)

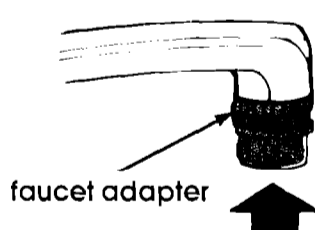

faucet adapter

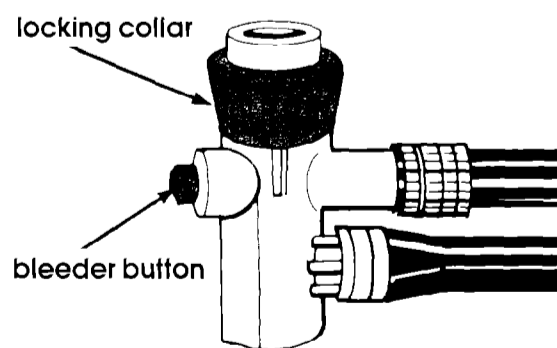

locking collar

bleeder button

**15.** Turn the hot water on until it is hot. Turn faucet off. Unwind combination hose from storage bracket. Attach hose connector to faucet by pulling down on the locking collar while pushing the connector over the faucet adapter. It will snap into place. Release locking collar.

**16.** Turn on the water faucet slowly to the full open position. Check for leaks. Tighten couplings if necessary.

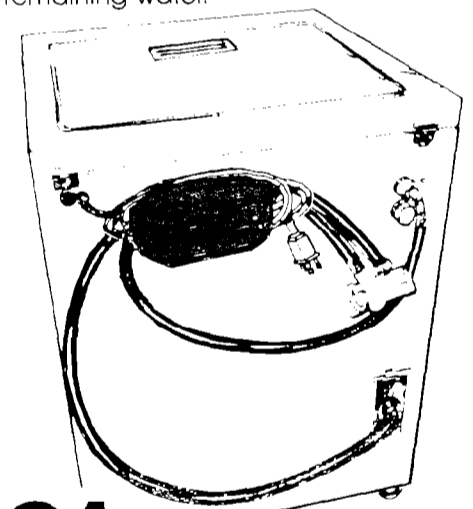

**21.** Wrap electrical cord and combination hose around storage bracket.

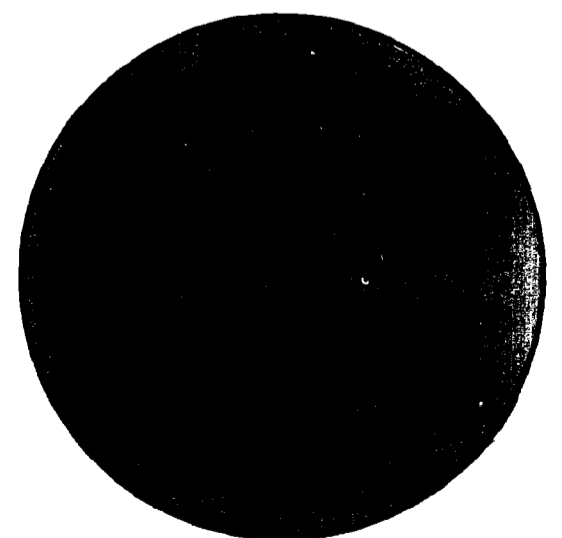

### Permanent installation

To permanently install your convertible compact washer you need the Permanent Installation Kit 285418 available from your Whirlpool dealer.

Numbers correspond to steps.

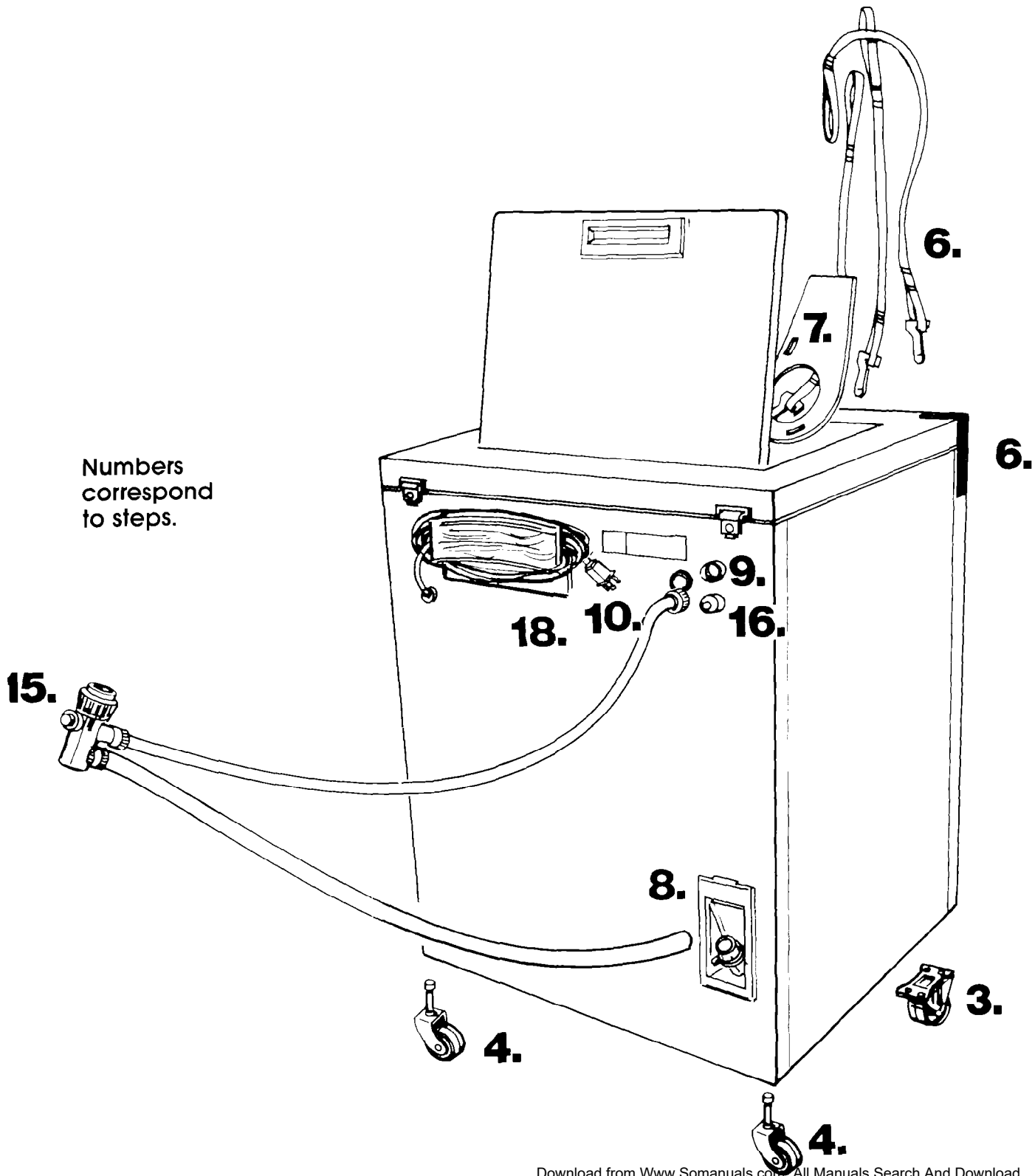

## Recessed area instructions.

This washer may be installed in a recessed area or closet.

The installation spacing is in inches and is the minimum allowable. Additional spacing should be considered for ease of installation and servicing.

If closet door is installed, the minimum air openings in top and bottom are required. Louvered doors with air openings in top and bottom are acceptable.

Companion appliance spacing should be considered.

This compact washer may be installed with the compact dryer companion appliance using the Stack Stand Kit, Part No. 695570. Only permanently installed units may be used with Stack Kits, Part Nos. 3390175 (White) or 3390196 (Almond).

Note: There are exhaust restrictions on recess and closet installations for dryers. Refer to dryer instructions for proper installation.

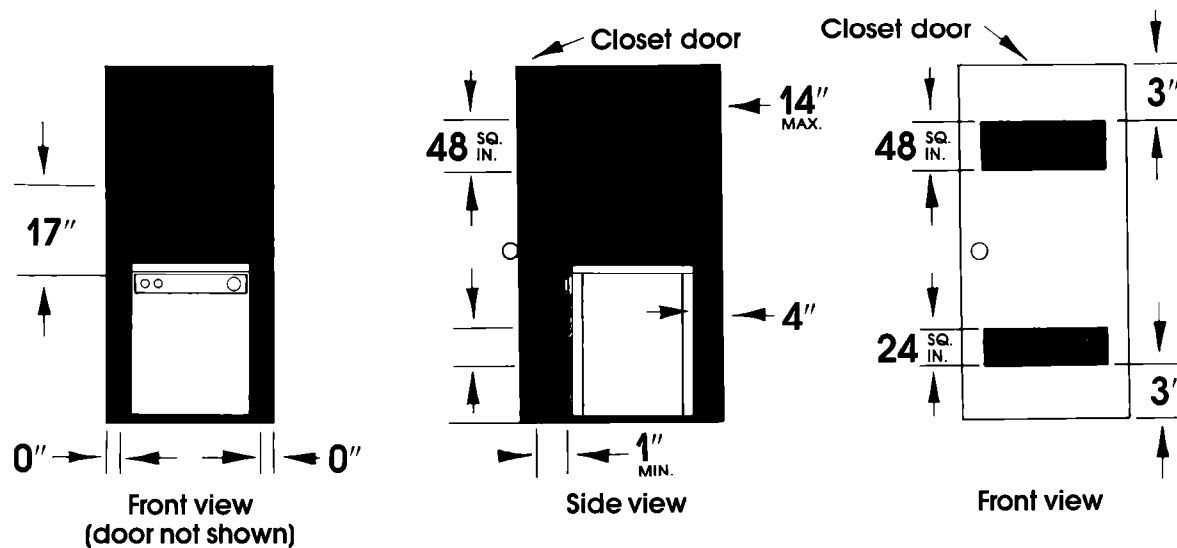

17" required for complete lid opening – 9" minimum allowable.

Minimum installation spacing.



## Free Manuals Download Website

<http://myh66.com>

<http://usermanuals.us>

<http://www.somanuals.com>

<http://www.4manuals.cc>

<http://www.manual-lib.com>

<http://www.404manual.com>

<http://www.luxmanual.com>

<http://aubethermostatmanual.com>

Golf course search by state

<http://golfingnear.com>

Email search by domain

<http://emailbydomain.com>

Auto manuals search

<http://auto.somanuals.com>

TV manuals search

<http://tv.somanuals.com>