

Estate

Use And Care

GUIDE

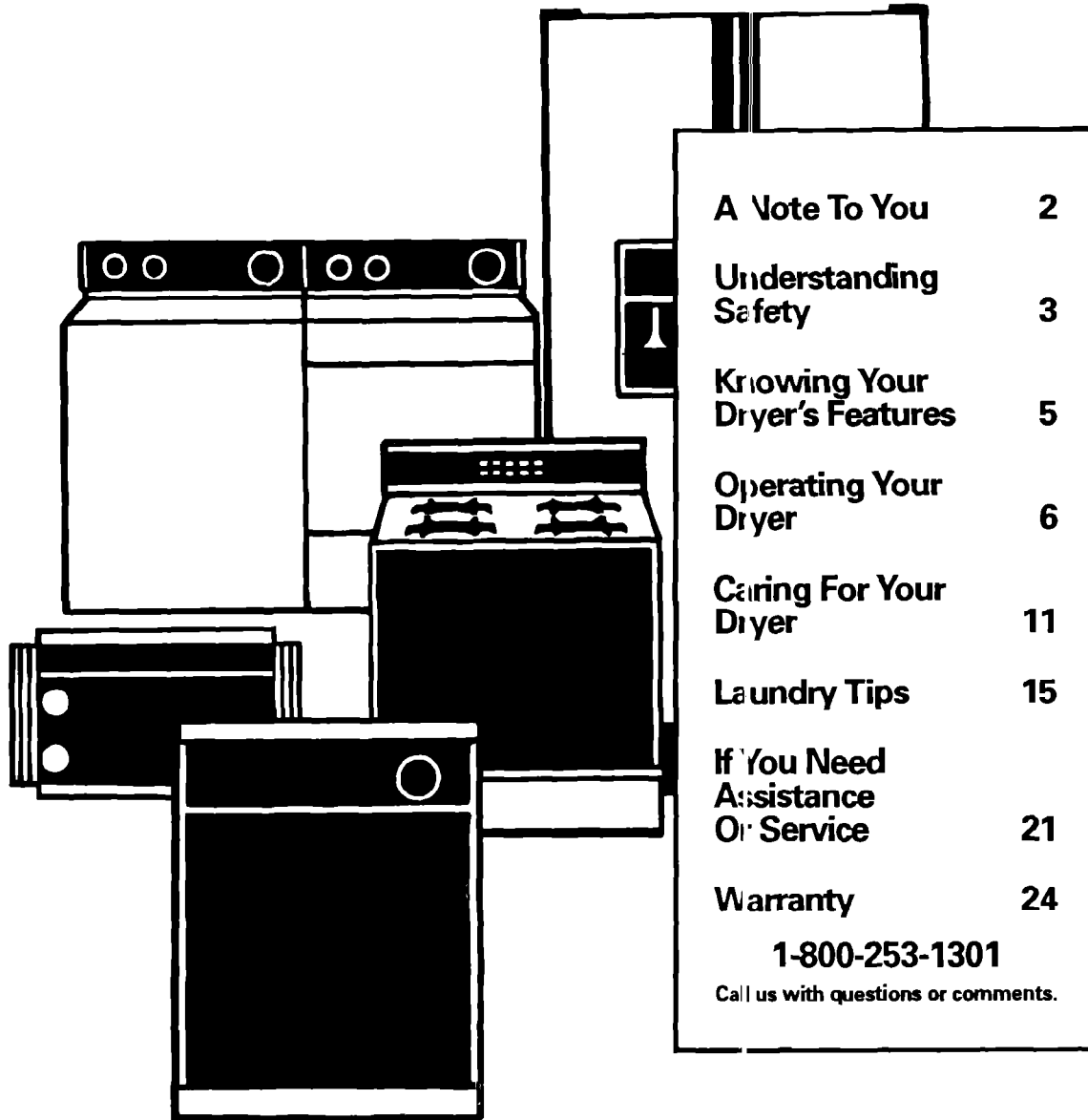

A Note To You 2

Understanding Safety 3

Knowing Your Dryer's Features 5

Operating Your Dryer 6

Caring For Your Dryer 11

Laundry Tips 15

If You Need Assistance Or Service 21

Warranty 24

1-800-253-1301

Call us with questions or comments.

ELECTRIC AND GAS DRYERS

PART NO. 3396311

9/93

A NOTE TO YOU

A Note To You

Thank you for buying an Estate® appliance.

You have purchased a quality, *world-class* home appliance. Years of engineering experience have gone into its manufacturing. Use this Use and Care Guide to safely and efficiently operate and maintain your appliance. Complete and mail the Ownership Registration Card provided with your appliance. This will help us notify you about any new information on your appliance.

Your safety is important to us.

This guide contains safety symbols and statements. Please pay special attention to these symbols and follow any instructions given. Here is a brief explanation of the use of each symbol.

WARNING

This symbol will help alert you to such dangers as personal injury, burns, fire and electrical shock.

CAUTION

This symbol will help you avoid actions which could cause product damage (scratches, dents, etc.) and damage to your personal property.

Our Consumer Assistance Center, 1-800-253-1301, is toll-free 24 hours a day.

If you have a question concerning your appliance's operation, or if you need service, first see "If You Need Assistance Or Service" on page 21. If you need further help, call us. When calling, you will need to know your appliance's complete model number and serial number. You can find this information on the model and serial number label (see diagram on page 5). For your convenience, we have included a handy place below for you to record these numbers, the purchase date from the sales slip and your dealer's name and telephone number. Keep this book and the sales slip together in a safe place for future reference.

Model Number _____

Dealer Name _____

Serial Number _____

Dealer Phone _____

Purchase Date _____

Understanding Safety

⚠ WARNING

For your safety the information in this manual must be followed to minimize the risk of fire or explosion or to prevent property damage, personal injury or loss of life.

–Do not store or use gasoline or other flammable vapors and liquids in the vicinity of this or any other appliance.

–WHAT TO DO IF YOU SMELL GAS:

- Do not try to light any appliance.
- Do not touch any electrical switch; do not use any phone in your building.
- Clear the room, building or area of all occupants.
- Immediately call your gas supplier from a neighbor's phone. Follow the gas supplier's instructions.
- If you cannot reach your gas supplier, call the fire department.

Installation and service must be performed by a qualified installer, service agency or the gas supplier.

IMPORTANT SAFETY INSTRUCTIONS

⚠ WARNING

To reduce the risk of fire, electrical shock, or injury to persons when using your dryer, follow basic precautions, including the following:

- Read all instructions before using your dryer.
- Do not machine wash or machine dry items cleaned, washed, soaked in, or spotted with wax, paint, gasoline, oil, dry cleaning solvents, and other flammable fluids. The fumes can create a fire hazard or explosion. Always hand wash and line dry items containing these materials.
- Do not allow children to operate, play with or crawl inside your dryer. Supervise children when your dryer is used near children.
- Do not reach into a dryer if the drum is moving.
- When removing from service or discarding a dryer, always remove the door to prevent accidental entrapment.
- Do not dry rubber, rubber-like, and heat sensitive materials with heat.
- Install and/or store dryer where it will not be exposed to the weather.
- Do not tamper with the controls.
- You are responsible for making sure that your dryer is installed, repaired and has parts replaced by a qualified person.
- Use only fabric softeners specifically labeled as not being harmful to the dryer.
- Do not allow lint to build-up inside the dryer or exhaust system. Cleaning should be done periodically by a qualified person.
- Clean lint screen before or after each load.
- Do not let dust, lint, paper, rags, chemicals, etc. pile up around or under the dryer.
- Dryer must be electrically grounded. See the Installation Instructions.

Understanding your responsibilities

- Never operate the dryer if:
 - it is not working right (i.e. noisy, too hot).
 - it is damaged.
 - parts are missing.
 - all panels are not in place.
 - the lint screen is loose, damaged or missing.
 - Unplug the power supply cord or turn off electrical power before attempting to service your dryer. Shut off gas valve if you have a gas dryer.
 - Do not wash or dry items that are soiled with vegetable or cooking oil. These items may contain some oil after laundering. Due to the remaining oil, the fabric may smoke or catch fire by itself.
 - Store flammable solvents or fluids away from your dryer.
 - Dry cleaning solvents or fluids should never be put directly into your dryer.
 - Be sure that your dryer:
 - is properly installed and leveled on a floor that can support the weight in a well-ventilated room.*
 - is connected to the proper outlet and electrical supply.*
 - is properly connected to fuel and exhaust systems (gas dryers must be vented outdoors).*
 - is not installed against draperies or curtains, or on carpet.*
 - is located in an area where the temperature is above 45°F (7°C).
 - is properly maintained.
 - is used only for jobs normally expected of home clothes dryers.
 - is not used by anyone unable to operate it properly.
- *See the Installation Instructions for complete information.

– SAVE THESE INSTRUCTIONS –

Knowing Your Dryer's Features

The parts and features of your dryer are illustrated below. Become familiar with all parts and features before using your dryer.

NOTE: The drawings in this book may vary from your dryer model. They are designed to show the different features of all models covered by this book. Your model may not include all features.

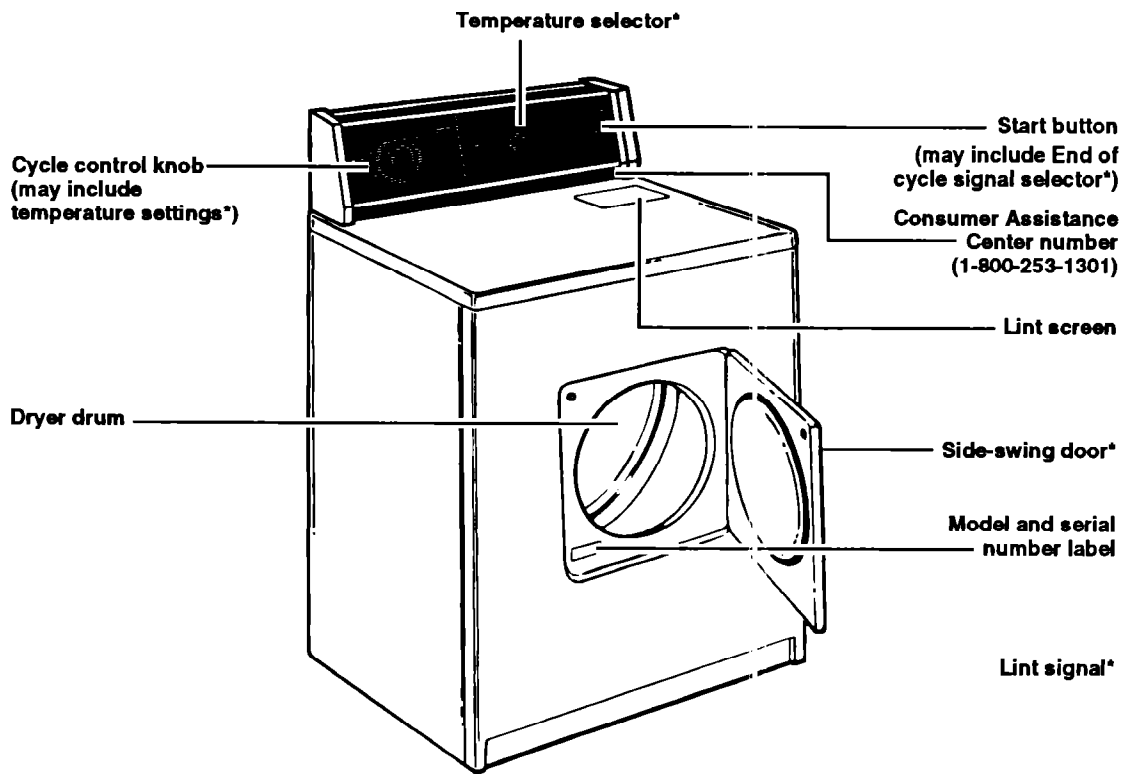

Other doors:

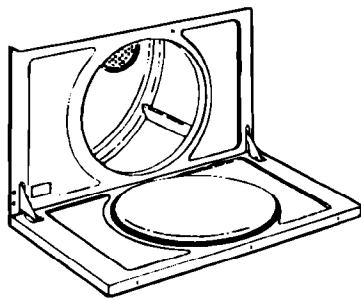

Full-width hamper door*

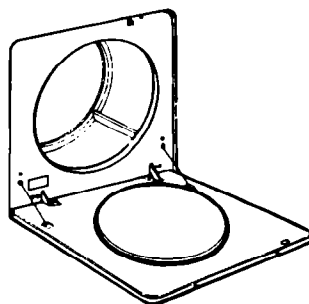

Mini-hamper door*

*Available on some models

Operating Your Dryer

In This Section

	Page		Page
Before starting your dryer	6	Understanding your cycles	7
Starting your dryer	6	Selecting the right cycle	9
Stopping your dryer	6	End of cycle signal	10
Restarting your dryer	6		

The information in this section helps you learn to use your dryer efficiently and safely. Refer to "Laundry Tips" on page 15 for additional control setting, sorting, and loading information.

Before starting your dryer

Wipe the dryer drum with a damp cloth before using to remove dust from storing and shipping.

If your dryer has a Consumer Buy Guide, remove it and place it with your Use and Care Guide.

Starting your dryer

1. Load clothes into the dryer and close the door.
2. Turn the Cycle Control Knob either way to the desired setting. (If your dryer has a Temperature Selector, set the selector to the desired setting.)
3. Push the Start Button.

NOTE: Your dryer stops automatically when a cycle ends.

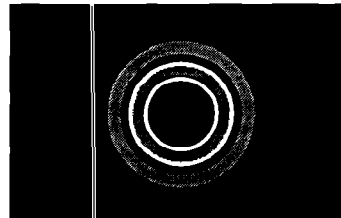

Push to start

Stopping your dryer

You can stop your dryer any time during a cycle. Open the dryer door or turn the Cycle Control Knob to OFF.

NOTE: The Cycle Control Knob should point to an OFF area when the dryer is not in use. If you want to stop the dryer before the cycle is finished, turn the Cycle Control Knob to an OFF area.

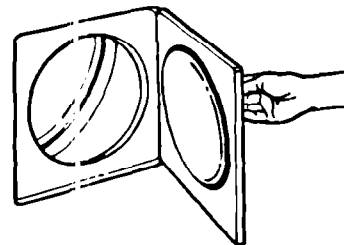

Restarting your dryer

1. Close the door.
2. Select a new cycle and temperature (if necessary).
3. Press the Start Button.

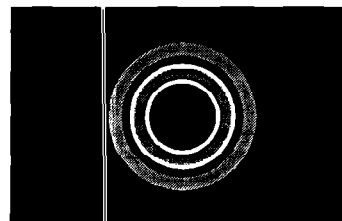

Push to start

Understanding your cycles

See the chart below for descriptions of the cycles that are on your dryer. See page 9 for help in selecting the right cycle.

NOTES:

- Use the Energy Preferred Automatic Setting (+) to dry most loads.
- The last few minutes of all cycles are without heat to make the load easier to handle.

- To help reduce wrinkling, remove the load from the dryer as soon as tumbling stops. This is important for permanent press, knits, and synthetic fabrics.
- Shaded areas in the illustrations show cycle locations.

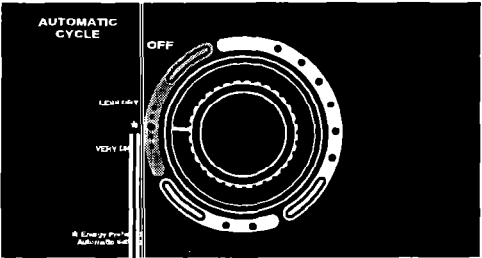
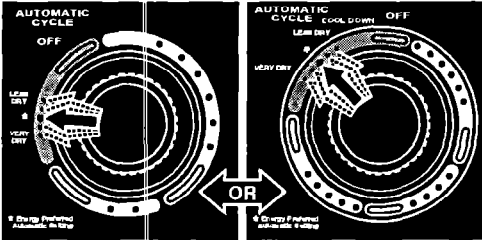
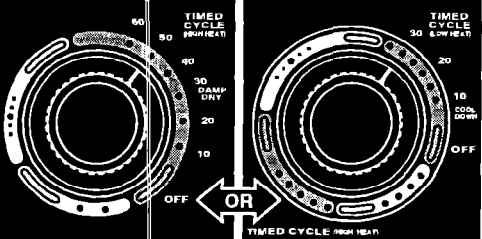
CYCLES (cycle names may vary with model)	CYCLE CONTROL KNOB (settings may vary with model)
<p>Automatic cycle(s) Use your automatic cycle to dry most loads.</p> <ul style="list-style-type: none"> • Your automatic cycle(s) shuts off when the selected dryness is reached. • The Cycle Control Knob will not move until the load is almost dry and the cool-down portion of the cycle has been reached. After the cool-down, the Cycle Control Knob automatically moves to an OFF area and tumbling stops. <p>The Energy Preferred Automatic Setting(+) correctly dries most loads.</p> <ul style="list-style-type: none"> • If the load is drier than you like, select a setting closer to LESS DRY the next time you dry a similar load. • If the load is not as dry as you like, complete drying using a Timed cycle. Select a setting closer to VERY DRY the next time you dry a similar load. <p>NOTE: Some models offer high heat and low heat automatic cycles. Select the cycle to match your load.</p>	 <p>Energy preferred automatic setting</p> 
<p>Timed cycle(s) Use your Timed cycle to complete drying if some items are damp after automatic drying. Timed drying is also useful to dry delicate items that require a short drying time.</p> <p>NOTE: Some models offer high heat and low heat timed cycles. Select the cycle to match your load.</p>	

continued on next page

OPERATING YOUR DRYER

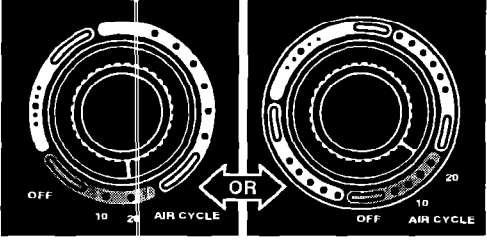
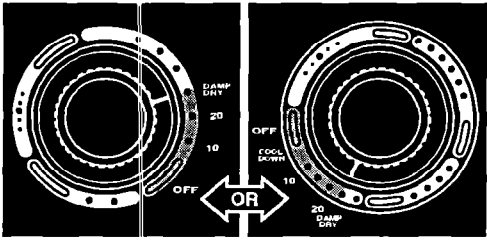
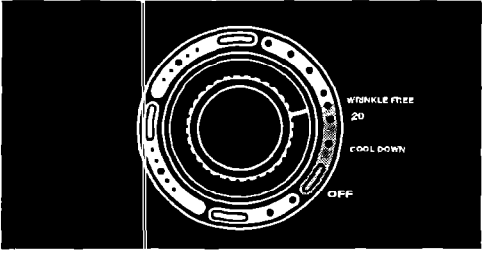
CYCLES (cycle names may vary with model)	CYCLE CONTROL KNOB (settings may vary with model)
<p>Air cycle (no heat)</p> <p>The Air cycle is unheated. Use this cycle to fluff or air dry bedding, plastic tablecloths, foam pillows, sneakers, etc. See Warning on page 9.</p>	
<p>Using the Damp Dry cycle (on some models)</p> <p>Use this cycle to dry items to damp level or to dry damp items that do not require an entire drying cycle. Two examples are heavy cottons, such as jeans, which you do not want to become stiff, or cotton clothes which are easier to press when damp.</p>	
<p>Using the Wrinkle Free cycle (on some models)</p> <p>The Wrinkle Free cycle removes wrinkles from clothes that have been packed in a suitcase, or from items not removed from the dryer at the end of a cycle. As soon as the dryer stops, fold or put the items on hangers.</p>	

Selecting the right cycle

Use the chart below to guide you when making drying selections. Use a timed cycle only if the recommended automatic cycle is not available on your dryer. (Your model may have cycles with one or two temperature settings.)

- Do not overdry. Overdrying can cause shrinkage, static cling, and damage to some fabrics.

⚠ WARNING

Fire Hazard

Do not dry heat-sensitive fabrics, plastic, rubber, or some stuffed items with heat. Use the Air cycle, or line dry.

Failure to do so could result in fire or damaged items.

TYPE OF LOAD <i>Check mark (✓) denotes the recommended setting. Select the setting available on your dryer.</i>	AUTO CYCLE(S)		TIMED CYCLE(S) minutes	
	High	Low	High	Low
COTTONS AND LINENS Extra Heavy—Bedspreads, mattress pads, quilts Heavyweight—Towels, jeans, corduroys, work clothes Mediumweight—Sheets, cotton underwear, diapers Lightweight—Batistes, organdies, lingerie	✓ ✓ ✓	✓	✓ 20	✓ 30
PERMANENT PRESS, SYNTHETICS AND BLENDS Heavyweight—Work clothes, jackets, raincoats Mediumweight—Shirts, play clothes, sheets, slacks Lightweight—Lingerie, blouses, dresses	✓ ✓	✓	✓ 20	✓ 30
KNITS Heavyweight—Cottons, rayons, blends, T-shirts, slacks, shirts Mediumweight—Synthetics (polyester, acrylic, etc.), dress slacks, skirts, sweaters Lightweight—Synthetics (polyester, acrylic, etc.) and blends, lingerie, blouses, dresses	✓ ✓	✓	✓ 20	✓ 30
DELICATE FABRICS Sheer curtains (2 or 3 panels), gauze, lace, etc.	Use Air cycle, 20-30 min			
RUBBER, PLASTIC, HEAT-SENSITIVE FABRICS Foam Rubber—Pillows, bras, stuffed toys Plastic—Shower curtains, tablecloths Rubber-backed rugs Olefin, Polypropylene, Sheer nylon	Use Air cycle, 20-30 min Use Air cycle, 20-30 min Use Air cycle, 40-50 min Use Air cycle, 10-20 min			

End of cycle signal

(on some models)

The dryer sounds a signal to let you know when the cycle is finished. The signal is helpful when you are drying permanent press, synthetics, and other items that should be taken out as soon as the dryer stops.

The signal is not adjustable but can be turned off (on some models). If your model has an End of Cycle Signal selector:

- Turn the Start Button (End of Cycle Signal Selector) to ON if you desire a signal; turn to OFF if you do not desire a signal.

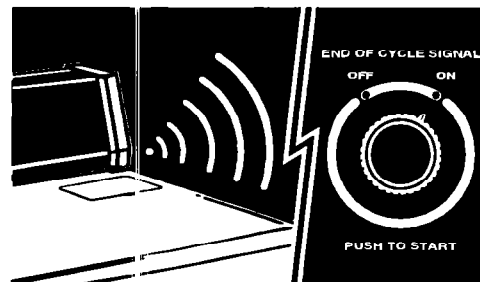

Caring For Your Dryer

In This Section	Page	Page	
Maintenance-every load	11	Maintenance-as needed	12

Dryers require regular maintenance. Follow the suggestions below to maintain your dryer properly.

Maintenance-every load

Cleaning the lint screen

The lint screen is located under a lid on top of the dryer. **Clean it before each load.** A screen blocked by lint can increase drying time.

1. Open the lid and pull the lint screen straight out.
2. Roll lint off the screen with your fingers. Do not rinse or wash the screen to remove lint. Wet lint is hard to remove.
3. Push the lint screen firmly back into place and close the lid.

CAUTION

Product and Fabric Damage Hazard

Do not run the dryer with the lint screen loose, damaged, blocked or missing. Doing so can cause overheating and damage to both the dryer and fabrics.

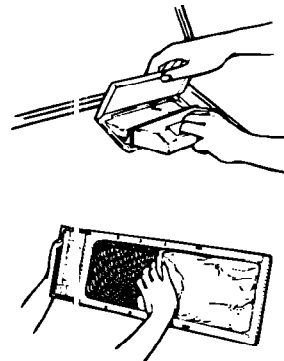

Lint signal

(on some models)

Restricted airflow reduces drying efficiency. The signal (a whistle tone) lets you know if the airflow is restricted.

- Turn off the dryer and clean the lint screen.

NOTE: Clean your lint screen before each load. Do not wait for the lint signal. The lint signal indicates excessive lint present on your lint screen. If you wait for the lint signal before you clean the lint screen, drying efficiency will be reduced.

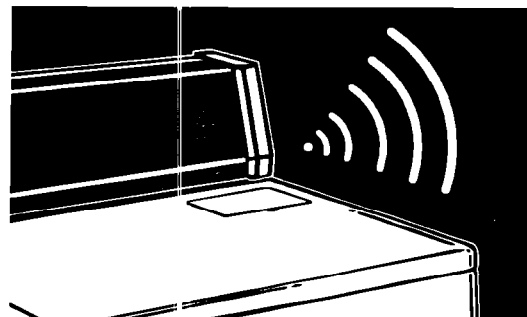

Maintenance-as needed

Use the following suggestions about cleaning and lint removal to maintain your dryer and keep it operating efficiently.

Cleaning a clogged lint screen

Laundry detergents and fabric softeners can cause a residue build-up on the lint screen. A clogged lint screen can extend drying times. Clean the lint screen every six months or more frequently if it becomes clogged due to a residue build-up. Use the following method:

1. Wet both sides of lint screen with hot water.
2. Wet a nylon brush with hot water and liquid detergent.
3. Scrub lint screen with the brush until all residue build-up is removed.
4. Rinse with hot water.
5. **Thoroughly** dry lint screen with a clean towel and replace in dryer.

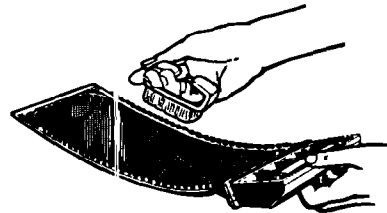

Cleaning the dryer interior

⚠ WARNING

Electrical Shock, Personal Injury and Fire Hazard

- Turn off the electrical power before cleaning the interior.
 - Make sure the dryer is cool.
 - Use nonflammable cleaner.
- Failure to do so could result in electrical shock or injury, fire or explosion.

Garments which contain unstable dyes, such as denim blue jeans or brightly colored cotton items, may discolor the dryer interior. If you want to remove stains from dryer drum, use powdered laundry detergent.

1. Make a paste with detergent and very warm water.
2. Apply paste to a soft cloth and scrub area until all excess dye is removed.
3. Wipe thoroughly with a damp cloth.
4. Tumble a load of rags to dry.

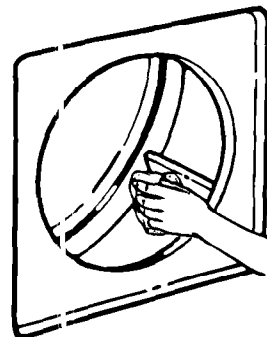

Cleaning the dryer exterior

Wipe with a soft, damp cloth.

Removing accumulated lint

Lint can gather inside the dryer and be a fuel for fire. It is recommended that lint be removed every 2 to 3 years, or more often, depending on dryer usage. Cleaning should be done by a qualified person. If you have any questions, please call our Consumer Assistance Center at 1-800-253-1301.

For all electric dryers, or gas dryers which have a lower front access panel

NOTE: See page 14 if your dryer is gas and has a full front panel.

1. Unplug the power supply cord or turn off the electrical power.
2. Remove back panel (electric) or lower front access panel (gas). See the Installation Instructions.
3. Remove lint from shaded area in illustration with a soft brush or vacuum cleaner. Avoid damaging wires, thermostats (electric), funnel (gas) or ignitor (gas).
4. Replace panel; reconnect and level dryer again, if necessary.

⚠ WARNING

Electrical Shock and Personal Injury Hazard

- Unplug the power supply cord or turn off the electrical power before removing dryer panels.
- Make sure the dryer is cool.
- Dryer parts can have sharp edges. Use care when handling.
- When replacing front panel after lint removal, the wire clips holding the door switch wires must be anchored to top of front and side panels. Wires **MUST NOT** touch rotating drum. (See page 14, Step 7.)

Failure to do so could result in electrical shock or personal injury.

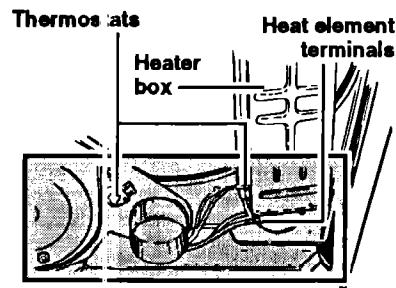

Electric dryer with back panel removed

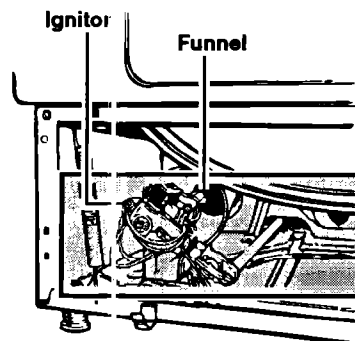

Gas dryer with lower front access panel removed

CARING FOR YOUR DRYER

If your dryer is gas and has a full front panel, remove front panel as follows

1. Unplug the power supply cord or turn off the electrical power.
2. Open lint screen lid. Remove two screws from lint screen area.
3. Open top by pulling forward and up at each front corner (see View A). Rest raised top against wall behind dryer (top is hinged at rear).
4. Remove two internal screws from front panel flanges (near top front corners). Lift front panel slightly, lifting off lower clips (see View B). Slowly pull front panel forward, disengaging panel from drum. (Drum will drop slightly.)
5. Move front panel aside and rest edge against side of dryer. Avoid disconnecting wire clips (see View C) or damaging wires.
6. Remove lint from area shown in "gas dryer" illustration on page 13 with soft brush or vacuum cleaner. Avoid damaging wires, funnel or ignitor.
7. Reassemble in reverse order. Before closing the top, check the following:
 - Drum seal must be flared out (see View D) and properly positioned against panel at back of drum. Rotate drum counter-clockwise one full turn to check drum seal.
 - Belt should be centered and tight on dryer drum.
 - Wire clips which hold the door switch wires must be anchored in slot in top of front panel (see View C) and along top edge of side panel. Door wires must not touch drum when dryer is operating. **See Warning, page 13.**
8. Replace top panel and lint screen screws. Top and front panels must be securely in place before operating dryer.
9. Reconnect power and level dryer again (if necessary).

NOTE: Call our Consumer Assistance Center at 1-800-253-1301 for assistance or more information.

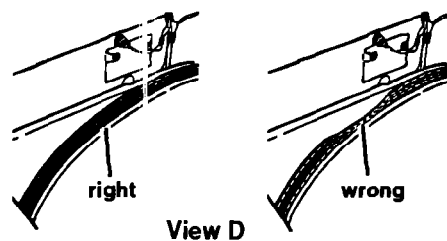
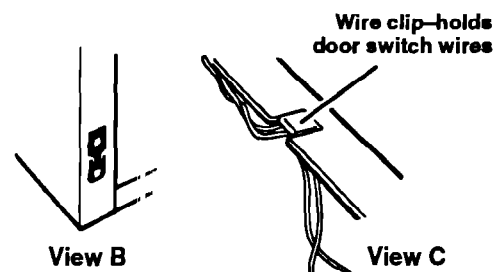
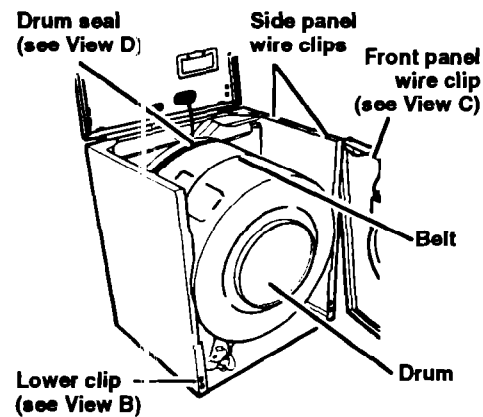
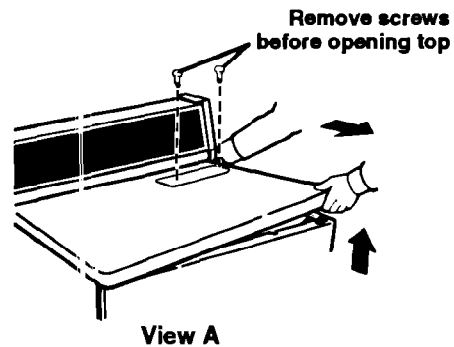

Laundry Tips

In This Section			
	Page		Page
Before you dry	15	Saving energy	18
Drying special-care items	16	Vacation care	18
Using dryer fabric softeners	18	Solving laundering problems	19

This section reviews proper drying techniques, gives you additional drying information, and discusses causes or solutions to common drying problems.

Before you dry

Before using your dryer, see pages 3 and 4 for Important Safety Information.

Drying tips

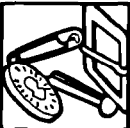
- Close zippers, snaps, and hooks to avoid snagging other items. Remove pins, buckles, and other hard objects to avoid scratching the dryer drum. Remove heat-sensitive trim that can be damaged by drying.
 
- Check garments to make sure all spots and stains were removed during the wash. If stains were not removed, do not tumble dry. Heat may permanently set stain. Soiled items can also leave stains on the dryer drum. These stains can be picked up by other items in the load.
- Empty all pockets. Sharp or heavy objects can damage your washer or dryer. Do not lay these objects on your washer or dryer after emptying pockets. Turn pockets of heavy items inside out for even drying.
 
- Tie strings and sashes so they will not tangle.
- Turn lint takers and dark items inside out to help prevent lint pickup.
- Place small items such as baby socks or hankies in a mesh bag for easier removal.
- Articles to be ironed should be removed from the dryer while still damp.

Sorting

- Separate dark from light colors; colorfast from noncolorfast. Items properly sorted for washing are usually properly sorted for drying. Separate heavy fabrics (denim, towels) from light fabrics (synthetics, permanent press).
 
- Separate lint givers (towels, chenille) from lint takers (corduroy, synthetics, permanent press). When possible, turn lint takers inside out.

Load sizes

- Mix large items with smaller items. Load the dryer by the amount of space items take up, not by their weight. Do not overload the dryer. Overcrowding causes uneven drying and wrinkling, and can cause items to wear out faster (because of pilling).
 
- You may need to rearrange large items (sheets, blankets, tablecloths) during a cycle to reduce balling or rolling up.
- Reduce wrinkling of permanent press and synthetics by drying smaller loads and removing items from the dryer as soon as tumbling stops.
- For better tumbling action when drying only a few small items, add one or two lint-free towels. This also prevents small, lightweight items from blocking airflow.

Drying special-care items

Most garments and household textiles have care labels with laundering instructions. Always follow label directions when they are available. General drying instructions for some special washables are included in this section.

<p>Air drying (heat sensitive items)</p> <hr/> <p>Heat-sensitive fabrics</p> <ul style="list-style-type: none"> • Olefin, polypropylene, sheer nylon • Cotton and canvas shoes <p>Pillows, stuffed toys</p> <ul style="list-style-type: none"> • Feather, foam, polyester <p>Plastic, rubber items</p> <ul style="list-style-type: none"> • Shower curtains, tablecloths, baby panties <p>Scatter rugs</p>	<p>Heat sensitive fabrics, plastic, rubber or some stuffed items require drying without heat. Use an Air setting or line dry. The Air setting is useful for fluffing bedding and pillows, and dusting draperies and clothing. See Warning on page 9.</p> <p>Follow care label directions.</p> <p>If shoes can be machine laundered:</p> <ol style="list-style-type: none"> 1. Place several bath towels in the dryer to act as a buffer, or place shoes on drying rack if your dryer has one. 2. If rubber or foam rubber materials are part of the shoe, use an Air setting. For other materials, see page 9 for cycle, time, and temperature recommendations. 3. Remove shoes from dryer while still damp and allow to air dry. <p>If manufacturer recommends machine washing, dry one pillow at a time and:</p> <ol style="list-style-type: none"> 1. Make sure coverings are securely stitched. 2. Shake and fluff the items by hand several times during the cycle. 3. Make sure pillows are completely dry. Feather pillows take a long time to dry. <p>Follow care label directions.</p> <p>Follow care label directions.</p>
<p>Blankets and woolens</p> <hr/> <ul style="list-style-type: none"> • Cotton, rayon, synthetic blankets • Electric blankets, electric sheets, woolen blankets, washable woolen garments 	<p>Machine drying knitted woolens is not recommended. Block to shape when wet and allow to air dry. Line dry blankets in shade on a breezy day over two lines. Pin edges together and straighten them. When partly dry, turn the blanket over, repin and restraighten. When dry, brush nap.</p> <p>Dray as recommended for permanent press fabrics on page 9.</p> <p>If manufacturer recommends machine drying:</p> <ol style="list-style-type: none"> 1. Place one or two dry towels in the dryer and preheat 3-5 minutes on a high setting. This will dry blankets faster and help avoid pilling. 2. Put blanket in dryer with warm towels. Set control for 20 minutes. 3. Check after 10 minutes. Remove when still damp. Overdrying and long tumbling can cause shrinking and pilling. 4. Place blanket on flat surface or over two lines to finish drying. Gently stretch to original size and shape. 5. When completely dry, brush gently to raise nap. Press binding with cool iron if needed.

LAUNDRY TIPS

<p>Curtains, slipcovers</p> <ul style="list-style-type: none"> • Draperies, slipcovers • Sheers, some synthetic curtains • Bonded or laminated fabrics 	<p>Remove drapery weights and hooks before laundering. For slipcovers, replace while still slightly damp. They will dry to fit tightly. Dry only a few minutes.</p> <ol style="list-style-type: none"> 1. Leave room in dryer for load to fluff. 2. Remove from dryer while slightly damp. Do not overdry. <p>Dry only a few minutes.</p> <p>Line dry these items.</p>
<p>Diapers, baby clothes</p>	<p>Wash and dry small items in a mesh bag or pillowcase for convenient handling.</p> <ol style="list-style-type: none"> 1. Dry according to manufacturer's instructions. 2. Remove diapers and cotton knit items while still slightly damp. They will feel softer, shrink less, and be easier to fold.
<p>Elastic items</p>	<p>Remove from dryer while still slightly damp.</p>
<p>Fiberglass materials</p>	<p>Do not machine wash or dry fiberglass materials. Small particles can stick to fabrics washed or dried in following loads and cause skin irritation.</p>
<p>Flame-retardant finishes</p>	<p>Some items have been treated with a flame-retardant finish to improve their resistance to burning. Such items are clearly labeled. To retain flame-retardant qualities through continuous use and washing, clean and dry according to the manufacturer's instructions.</p>
<p>Napped items</p> <ul style="list-style-type: none"> • Corduroy, velveteen 	<p>Dry separately or with similar colors to avoid lint transfer. Follow care label directions.</p> <ol style="list-style-type: none"> 1. Dry according to manufacturer's instructions. 2. Remove from dryer while there is still a trace of moisture. 3. Smooth, reshape and air dry before putting away.
<p>Quilted, down-filled items</p>	<p>Follow care label instructions.</p> <ol style="list-style-type: none"> 1. Dry one at a time. 2. Remove from dryer and shake or fluff the item during the drying cycle. 3. Smooth and reshape before putting away.
<p>Snowsuits, jackets</p> <ul style="list-style-type: none"> • Nylon, polyester-base 	<p>Check label for fiber content, then follow care label directions.</p> <p>Dry according to manufacturer's instructions.</p> <ol style="list-style-type: none"> 1. Dry garment for about 10 minutes. Remove and turn inside out. Dry for 10 more minutes. 2. Remove from dryer immediately and hang on a nonrusting hanger to finish drying. This will help eliminate wrinkles.
<p>Tinted, dyed or noncolorfast items</p>	<p>Dry according to fabric, weight and care label instructions. Wipe the dryer drum carefully to remove any dye or lint that can be transferred to other loads. See "Cleaning the dryer interior" on page 12.</p>

continued on next page

LAUNDRY TIPS

Towels	Select cycle according to fabric type. Some towels, particularly those made of a blend of synthetic fibers and natural fibers (polyester and cotton blends), may shed more lint than other towels causing your dryer's lint screen to get full faster. Be sure to remove lint from the dryer lint screen before and after drying new towels.
Washable knits	Do not overdry knits. Overdrying can cause shrinking and static cling. <ol style="list-style-type: none">1. Select cycle according to fabric and construction.2. Turn synthetics and blends inside out when drying to avoid pilling.3. Remove cotton and rayon knits while still slightly damp. Stretch into shape and lay flat to finish drying.

Using dryer fabric softeners

Dryer fabric softeners are recommended for reducing static cling (static can also be reduced by not overdrying) and for softening fabrics. Always follow package instructions carefully.

- Put fabric softener sheet on top of the load **before starting the dryer**. Do not add a fabric softener sheet **after** the cycle has started. Instant heat can cause the fabric softener to spot fabrics.
- Clear, grease-like spots can result from the fabric softener sheet becoming tangled in an item during tumbling. If fabric softener causes a stain, wet the stain and rub with liquid detergent or bar soap, rewash.
- Some fabric softeners can clog the lint screen and slow drying. Use fabric softeners labeled as dryer safe.

Saving energy

- Use your automatic cycle to dry most loads.
- Dry only full loads without overdrying.
- Avoid overloading dryer, adding wet items to a partly dried load, or opening the door unnecessarily.
- Plan your laundry to dry one load after another. A warm dryer shortens drying time.
- Shorten drying times by exhausting dryer properly and cleaning exhaust duct and outside exhaust hood as needed.
 - Keep the lint screen clean.
 - Use your dryer in a room where room air temperature is above 45°F (7°C).
 - Sort loads by fabric weight and type.

Vacation care

1. Unplug power supply cord or turn off electrical power supply.
2. Clean lint screen.

Solving laundering problems

Most laundering problems are easily solved. Check the following list for problems you may have and possible causes. If you need additional help, check the "Assistance or Service" section of this book.

PROBLEM	CHECK IF	CAUSES/SOLUTIONS
Greasy spots	<p>Dryer fabric softeners were used</p> <p>Undiluted washer fabric softener was used</p> <p>Enough detergent was used</p> <p>Items were clean before they were dried</p>	<p>Follow manufacturer's directions carefully.</p> <p>Dilute fabric softener before adding to the final rinse.</p> <p>Use enough detergent to hold soil in the wash water until it drains away. Undrained soil can stick to outer tub of the washer and cause greasy spots with next load.</p> <p>Soiled items can stain other items in the load. They can also leave stains on the dryer drum that can be picked up by items in later loads. Dryer heat may permanently set these stains.</p>
Lint	<p>Lint screen is clogged</p> <p>Load is properly sorted</p> <p>Static electricity is attracting lint</p> <p>Load is too big or heavy</p> <p>Paper or tissue was in pocket</p> <p>Enough detergent was used</p> <p>Pilling is being mistaken for lint</p>	<p>Clean lint screen. (See page 11.)</p> <p>Sort lint-givers (bath towels, etc.) from lint-takers (synthetics, permanent press).</p> <p>Use fabric softener in the washer's final rinse. Use correct dryer settings for fabric. Overdrying synthetics can cause lint-attracting static electricity.</p> <p>Dry smaller loads. When items can't tumble freely, air is unable to carry lint to lint screen.</p> <p>Empty pockets carefully. A small scrap of paper can cause a lot of lint.</p> <p>Use enough detergent to hold the lint in the water until it drains away. Base detergent amount on water hardness and soil in wash load.</p> <p>Pilling (surface fuzz) is caused by normal wear and laundering. Pills do not break away easily from the fabric and can often collect lint. Synthetic fabrics are more likely to pill than others, especially at neckbands, elbows and knees.</p>

continued on next page

LAUNDRY TIPS

PROBLEM	CHECK IF	CAUSES/SOLUTIONS
Shrinking	<p>Items are overdried</p> <p>Fabric type and quality is suitable for drying</p>	<p>Remove items while there is still a trace of moisture. Some items should be removed while damp, then shaped and air dried.</p> <p>Some knits are stretched during manufacturing. Washing and drying returns them to the original size. This is normal. Check quality of garment before buying. Follow fabric care label directions carefully.</p>
Slow drying	<p>There is a large amount of moisture in the load to be dried</p> <p>Cold rinse water is used</p> <p>Room air temperature is below 45°F (7°C)</p> <p>Dryer is exhausted according to Installation Instructions</p> <p>Lint screen is clogged</p> <p>Exhaust duct or outside exhaust hood is clogged</p> <p>Proper electrical supply is used</p>	<p>Some items hold more moisture than others (cottons more than polyester). They take longer to dry. Full loads take longer to dry than small loads of the same fabric.</p> <p>A load rinsed in cold water will take slightly longer to dry than a warm one. Cold rinses, however, help save energy and reduce wrinkling more than warm rinses do.</p> <p>Install dryer in a room where the air temperature is warmer than 45°F (7°C). Cold air increases drying time and may cause wrinkles not to be removed.</p> <p>Install and exhaust your dryer according to the Installation Instructions provided.</p> <p>Clean lint screen before or after each use.</p> <p>Clean if needed.</p> <p>Properly connect the dryer to a grounded electrical circuit that meets the electrical requirements stated in the Installation Instructions</p>
Static electricity	<p>Load is overdried</p> <p>Fabric softener is used</p> <p>Synthetics, synthetic blends, permanent press and knits are in load</p>	<p>Remove items while there is still a trace of moisture.</p> <p>Use a fabric softener and follow package directions carefully.</p> <p>Synthetics, synthetic blends, permanent press and knits build up static electricity. Use a fabric softener and be careful not to overdry the load.</p>

If You Need Assistance Or Service

1. Before calling for assistance ...



Is the power cord plugged in?

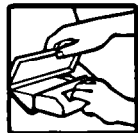

Is lint screen clogged with lint?

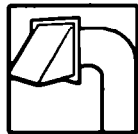

Is exhaust duct or outside exhaust hood clogged with lint?



Have you blown a fuse or tripped the circuit breaker?

If you need more help, check the chart below.

PROBLEM	CHECK THE FOLLOWING
Dryer will not run	Is the power cord firmly plugged into a live circuit with proper voltage? Has a household fuse blown or circuit breaker tripped? Has a time-delay fuse been used? Is the dryer door firmly closed? Did you firmly push the Start Button? Are the controls set in an ON position?
Dryer will not heat	Is the cycle in the last few minutes? (There is no heat during that time.) Has a household fuse blown or circuit breaker tripped? Has a time-delay fuse been used? If you have a gas dryer, are the valves open on both the dryer and the supply line?
Drying time too long	Is your lint screen clean? (See the "Slow drying" section of the table on page 20 for additional information.) Is your exhaust duct or outside exhaust hood clogged with lint?

IF YOU NEED ASSISTANCE OR SERVICE

2. If you need assistance* ...

Call our toll-free number. Dial toll-free from anywhere in the U.S.A.:

1-800-253-1301

and talk with one of our trained consultants. The consultant can instruct you in how to obtain satisfactory operation from your appliance or, if service is necessary, recommend a qualified service company in your area.

If you prefer, write to:

Mr. William Clark
Consumer Assistance Representative
Whirlpool Corporation
2000 M-63
Benton Harbor, MI 49022

Please include a daytime phone number in your correspondence.

3. If you need service* ...

Contact the dealer from whom you purchased the appliance or the authorized servicer in your area. For help finding an authorized servicer in your area, call our toll-free telephone number in Step 2.

***When asking for help or service:**

Please provide a detailed description of the problem, your appliance's complete model and serial numbers and the purchase date. (See page 2.) This information will help us respond properly to your request.

4. If you need FSP® replacement parts ...

FSP is a registered trademark of Whirlpool Corporation for quality parts. Look for this symbol of quality whenever you need a replacement part for your Estate® appliance. FSP replacement parts will fit right and work right, because they are made to the same exacting specifications used to build every new Estate appliance.

To locate FSP replacement parts in your area, refer to Step 3 above or call our toll-free telephone number in Step 2.

5. If you are not satisfied with how the problem was solved ...

- Contact the Major Appliance Consumer Action Panel (MACAP). MACAP is a group of independent consumer experts that voices consumer views at the highest levels of the major appliance industry.
- Contact MACAP only when the dealer, authorized servicer and Whirlpool have failed to resolve your problem.
Major Appliance Consumer Action Panel
20 North Wacker Drive
Chicago, IL 60606
- MACAP will in turn inform us of your action.

ESTATE® Dryer Warranty

LENGTH OF WARRANTY	WHIRLPOOL WILL PAY FOR
FULL ONE-YEAR WARRANTY From Date of Purchase	FSP® replacement parts and repair labor to correct defects in materials or workmanship. Service must be provided by an authorized Whirlpool SM service company.
WHIRLPOOL WILL NOT PAY FOR	
<p>A. Service calls to:</p> <ol style="list-style-type: none"> 1. Correct the installation of your dryer. 2. Instruct you how to use your dryer. 3. Replace house fuses or correct house wiring or plumbing. 4. Replace owner accessible light bulbs. <p>B. Repairs when your dryer is used in other than normal, single-family household use.</p> <p>C. Pickup and delivery. Your dryer is designed to be repaired in the home.</p> <p>D. Damage to your dryer caused by accident, misuse, fire, flood, acts of God or use of products not approved by Whirlpool.</p> <p>E. Repairs to parts or systems caused by unauthorized modifications made to the appliance.</p>	

8-82

WHIRLPOOL CORPORATION SHALL NOT BE LIABLE FOR INCIDENTAL OR CONSEQUENTIAL DAMAGES. Some states do not allow the exclusion or limitation of incidental or consequential damages, so this limitation or exclusion may not apply to you. This warranty gives you specific legal rights, and you may also have other rights which vary from state to state.

Outside the United States, a different warranty may apply. For details, please contact your authorized Whirlpool distributor or military exchange.

If you need service, first see the "Assistance or Service" section of this book. After checking "Assistance or Service," additional help can be found by calling our Consumer Assistance Center telephone number, **1-800-253-1301**, from anywhere in the U.S.A.



Printed on recycled paper—
10% post consumer waste
50% recovered materials

PART NO. 3396311

© 1993 Whirlpool Corporation

® Registered Trademark/SM Service Mark of Whirlpool Corporation.

Printed in U.S.A.

Free Manuals Download Website

<http://myh66.com>

<http://usermanuals.us>

<http://www.somanuals.com>

<http://www.4manuals.cc>

<http://www.manual-lib.com>

<http://www.404manual.com>

<http://www.luxmanual.com>

<http://aubethermostatmanual.com>

Golf course search by state

<http://golfingnear.com>

Email search by domain

<http://emailbydomain.com>

Auto manuals search

<http://auto.somanuals.com>

TV manuals search

<http://tv.somanuals.com>