

Use And Care

G U I D E

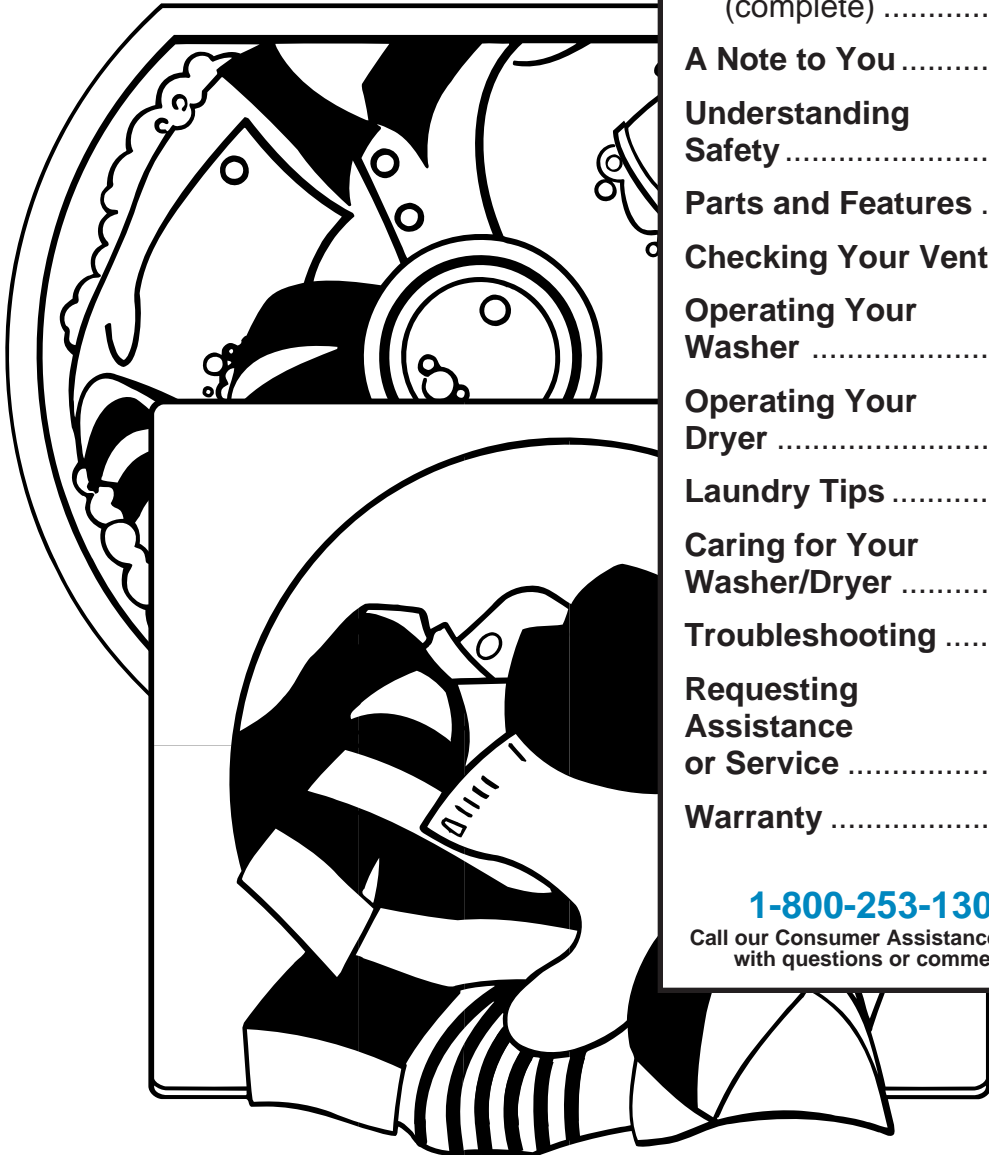

Table of Contents	
(complete)	2
A Note to You	3
Understanding Safety	4-5
Parts and Features	6
Checking Your Vent	7
Operating Your Washer	9
Operating Your Dryer	15
Laundry Tips	20
Caring for Your Washer/Dryer	29
Troubleshooting	33
Requesting Assistance or Service	37
Warranty	40

1-800-253-1301

Call our Consumer Assistance Center with questions or comments.

**LARGE CAPACITY
AUTOMATIC COMBO WASHER/DRYER**

PART NO. 3406874

Table of Contents

A Note to You	3	Laundry Tips	20
Understanding Safety	4-5	Sorting clothes	20
Parts and Features	6	Choosing load sizes	20
Checking Your Vent	7	Washing and drying tips	20
Venting	7	Using dryer fabric softeners	21
Operating Your Washer	9	Water guidelines	21
Starting your washer	9	Removing stains	23
Stopping/restarting your washer	10	Washing special-care items	26
Selecting a cycle and time	11	Drying special-care items	27
Using Rinse and Spin	12	Caring for Your Washer/Dryer	29
Using Drain and Spin	12	Every load cleaning – dryer	29
What happens in each cycle	13	As needed cleaning – washer	29
Self-cleaning lint filter	13	As needed cleaning – dryer	30
Adding liquid chlorine bleach	14	Removing accumulated lint from inside the dryer cabinet	31
Adding liquid fabric softener	14	Winter storage or moving care	32
Operating Your Dryer	15	Non-use or vacation care	32
Starting your dryer	15	Saving energy	32
Stopping/restarting your dryer	16	Troubleshooting	33
Selecting a cycle and setting	16	Requesting Assistance or Service	37
End of cycle signal	19	Warranty	40

A Note to You

Thank you for buying this appliance.

You have purchased a quality world-class appliance. To ensure that you enjoy years of trouble-free operation, we developed this Use and Care Guide. It contains valuable information about how to operate and maintain your washer properly and safely. Please read it carefully.

Also, please complete and mail in the Ownership Registration Card provided with your appliance. The card helps us notify you about any new information on your appliance.

Please record your model's information.

Whenever you call to request service on your appliance, you need to know your complete model number and serial number. You can find this information on the model and serial number label (see diagram in the "Parts and Features" section for location of label).

Please also record the purchase date of your appliance and your dealer's name, address, and telephone number.

Model Number _____

Serial Number _____

Purchase Date _____

Dealer Name _____

Dealer Address _____

Dealer Phone _____

Keep this book and the sales slip together in a safe place for future reference.

**Our Consumer Assistance Center
number is toll-free from anywhere
in the U.S.A.**

1-800-253-1301

Understanding Safety

Your safety and the safety of others is very important.

We have provided many important safety messages in this manual and on your appliance. Always read and obey all safety messages.



This is the safety alert symbol.

This symbol alerts you to hazards that can kill or hurt you and others.

All safety messages will be preceded by the safety alert symbol and the word "DANGER" or "WARNING." These words mean:

⚠ DANGER

You will be killed or seriously injured if you don't follow instructions.

⚠ WARNING

You can be killed or seriously injured if you don't follow instructions.

All safety messages will identify the hazard, tell you how to reduce the chance of injury, and tell you what can happen if the instructions are not followed.

IMPORTANT SAFETY INSTRUCTIONS

WARNING: To reduce the risk of fire, electric shock, or injury to persons when using the washer/dryer, follow basic precautions, including the following:

- Read all instructions before using the washer/dryer.
- Do not wash or dry articles that have been previously cleaned in, washed in, soaked in, or spotted with gasoline, dry-cleaning solvents, other flammable, or explosive substances as they give off vapors that could ignite or explode.
- Do not add gasoline, dry-cleaning solvents, or other flammable, or explosive substances to the wash water. These substances give off vapors that could ignite or explode.
- Under certain conditions, hydrogen gas may be produced in a hot water system that has not been used for 2 weeks or more. **HYDROGEN GAS IS EXPLOSIVE.** If the hot water system has not been used for such a period, before using the washing machine, turn on all hot water faucets and let the water flow from each for several minutes. This will release any accumulated hydrogen gas. As the gas is flammable, do not smoke or use an open flame during this time.

- Do not allow children to play on or in the washer/dryer. Close supervision of children is necessary when the washer/dryer is used near children.
- Before the washer/dryer is removed from service or discarded, remove the doors to the washing/drying compartments.
- Do not reach into the washer/dryer if the tub, agitator, or drum is moving.
- Do not install or store the washer/dryer where it will be exposed to the weather.
- Do not tamper with controls.
- Do not repair or replace any part of the washer/dryer or attempt any servicing unless specifically recommended in this Use and Care Guide or in published user-repair instructions that you understand and have the skills to carry out.
- Do not use fabric softeners or products to eliminate static unless recommended by the manufacturer of the fabric softener or product.
- Do not use heat to dry articles containing foam rubber or similarly textured rubber-like materials.
- Clean dryer lint screen before or after each load.
- Keep area around the dryer exhaust opening and adjacent surrounding areas free from the accumulation of lint, dust, and dirt.
- The interior of the machine and dryer exhaust vent should be cleaned periodically by qualified service personnel.
- See Installation Instructions for grounding requirements.

– SAVE THESE INSTRUCTIONS –

Parts and Features

The parts and features of your washer/dryer are illustrated on this page. Become familiar with all parts and features before using your washer/dryer. Page references are included next to some features. Refer to those pages for more information about the features.

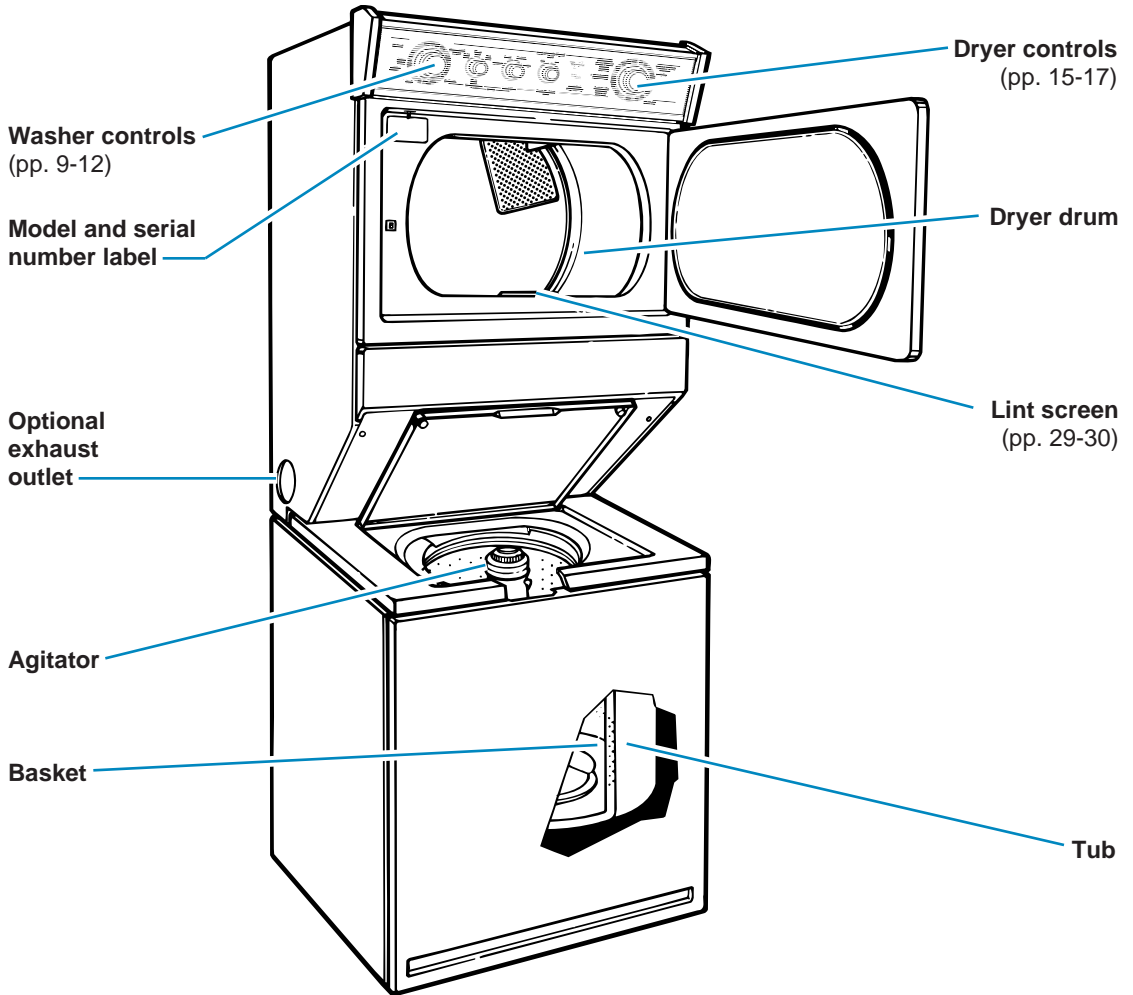

Additional features your washer/dryer has:

Self-cleaning lint filter (p. 13)

Automatic dryness control (Auto Sense Dry) (p. 17)

Selectable end of cycle signal (dryer) (p. 19)

Checking Your Vent

Your washer/dryer must be properly installed and vented to achieve maximum drying efficiency. Install your washer/dryer in a well-ventilated room where the temperature is always above 45°F (7°C). Also make sure that your washer/dryer is leveled. Refer to your Installation Instructions for more information.



⚠ WARNING

Fire Hazard

- Use a heavy metal vent.
- Do not use a plastic vent.
- Do not use a metal foil vent.
- Failure to follow these instructions can result in death or fire.

Venting

If the washer/dryer is not properly installed and vented, it will not be covered under the warranty.

NOTE: Service calls caused by improper venting will be paid for by the customer, whether it was a paid installation or self-installed. For paid installation, call the company that installed the vent for adjustment.

1. **Do not** use plastic vent or flexible metal foil vent. Use four-inch heavy metal or flexible metal vent. Do not kink or crush flexible metal vent. It must be completely extended to allow adequate exhaust air to flow. Check vent after installation. Refer to your Installation Instructions for proper length requirements of vent.

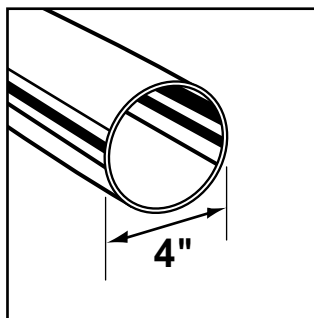

2. Use a 4" exhaust hood. Smaller hoods increase drying times.

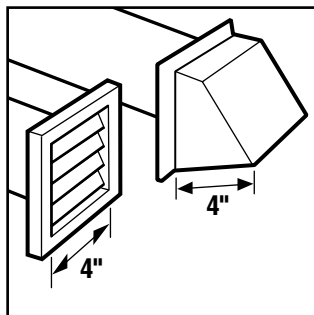

continued on next page

CHECKING YOUR VENT

3. The exhaust vent can be routed up, down, left, right, or straight out the back of the dryer. Space requirements are listed in your Installation Instructions.

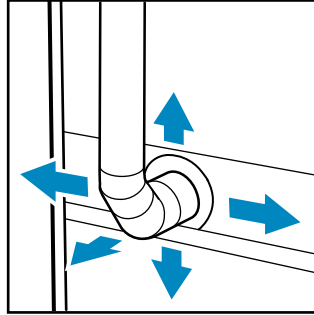

4. Use the straightest path possible when routing the exhaust vent. Avoid 90° turns, if possible. Allow room when using elbows or making turns. Bend vent gradually to avoid kinking.

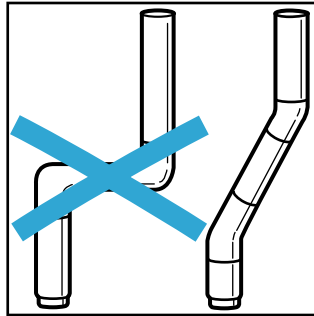

5. Use duct tape to seal all joints. **Do not** use screws to secure vent. Lint may catch on screws.

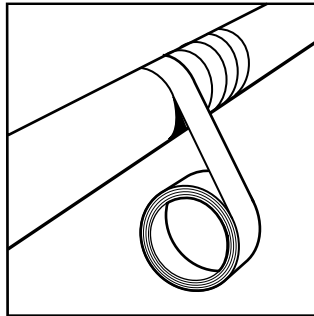

6. Clean exhaust vent periodically, depending on use, but at least every 2 years, or when installing your washer/dryer in a new location.
- Disconnect vent from the washer/dryer and clean one section at a time until you reach the exhaust hood.
 - Use the hose attachment on your vacuum, or a pole or wire with a feather duster or rag attached, to clean out lint.
 - Be sure the flapper on the outside end of vent moves freely.
 - When cleaning is complete, be sure to follow the Installation Instructions supplied with your washer/dryer for final product check.

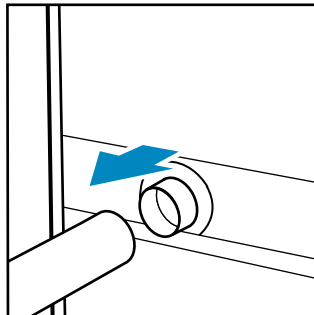

Operating Your Washer

To obtain the best washing results, you must operate your washer properly. This section gives you this important information.

⚠ WARNING



Explosion Hazard

Never place items in the washer that are dampened with gasoline or other flammable fluids.

No washer can completely remove oil.

Do not dry anything that has ever had any type of oil on it (including cooking oils).

Doing so can result in death, explosion, or fire.

Starting your washer

1. Add measured detergent to the washer. Then place a sorted load of clothes in the washer.

- Sort and load clothes as described in the “Laundry Tips” section.
- If desired, you may also add color safe bleach.

2. Close the washer lid.

3. Select a water level.

Turn the Water Level selector to the setting that corresponds with the size of the wash load and the type of fabric being washed.

- To change the water level setting after the washer has started, move the selector to the desired new setting.
- See the “Laundry Tips” section for loading tips.

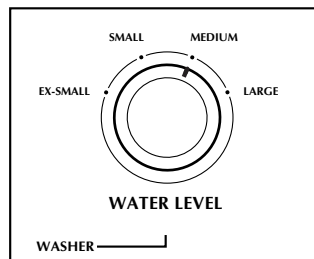

continued on next page

OPERATING YOUR WASHER

4. **Select a wash-rinse temperature with the Temperature selector. Match the water temperature with the type of fabric and soils being washed. See “Water guidelines” in the “Laundry Tips” section.**
 - Three wash-rinse temperatures are available: Cold-Cold, Warm-Cold, and Hot-Cold.
5. **Push in and turn the Cycle Control Knob clockwise. Stop when the indicator on the outer ring points to the number in the wash cycle you want.**
 - The numbers are minutes of wash time.
 - The cycles are described in “Selecting a cycle and time.”
6. **Pull out Cycle Control Knob to start washer.**
7. **(OPTIONAL STEP) If desired, add liquid chlorine bleach AFTER washer starts agitating.** See “Adding liquid chlorine bleach.”
8. **(OPTIONAL STEP) If desired, add measured and diluted fabric softener to the final rinse cycle.** See “Adding liquid fabric softener.”

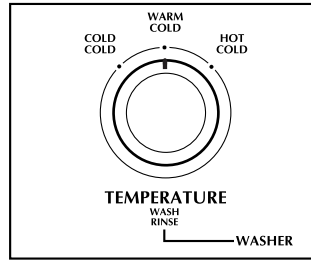

Stopping/restarting your washer

If necessary, you can stop your washer during a cycle to add more clothes.

- To **stop** the washer at any time, push in the Cycle Control Knob.
- To **restart** the washer, close the lid (if open) and pull out the Cycle Control Knob.

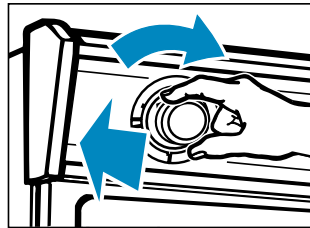

Selecting a cycle and time

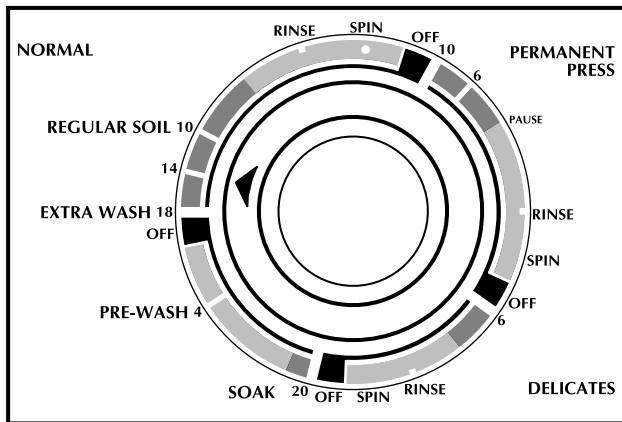

Use the information in this section to help you make the best cycle selections for your wash loads. Each cycle is designed for different types of fabrics and soil levels.

- The washer pauses briefly throughout each cycle. These pauses are normal for washer operation.
- To help you understand what happens during a wash cycle, see “What happens in each cycle.”

Normal cycle

The Normal cycle features the Gentle Wash system and high spin speeds to shorten drying time.

- Use 14 minutes of wash time to clean sturdily-constructed cotton and linen fabrics that are heavily soiled.
- Use 10 minutes of wash time to clean cotton and linen fabrics that are lightly to moderately soiled.

Permanent Press cycle

The Permanent Press cycle features the Gentle Wash system, a cool-down rinse, and low spin speeds to reduce wrinkling.

- Use 10 minutes of wash time to clean permanent press and some synthetic fabrics that are moderately soiled.
- Use 6 minutes of wash time to clean permanent press and some synthetics that are lightly soiled.

Delicates cycle

The Delicates cycle features a reduced agitation speed for gentle soil removal. Low spin speeds reduce wrinkling.

- Use 6 minutes of wash time to clean delicate items and washable knits that are lightly soiled.

Soak cycle

The Soak cycle features brief periods of agitation and soak time to help remove heavy soils and stains that need pretreatment.

- Use warm water when soaking laundry. (Hot water can set stains.) See “Removing stains” for stain removal information.
- Use the amount of detergent or presoak additive recommended by manufacturer.
- After the 20-minute Soak cycle ends, add detergent and set a new wash cycle.
- The **4-minute Pre-Wash** time features high-speed agitation to loosen stains. Once the Pre-Wash period ends, add detergent and start a new wash cycle.

continued on next page

Extra Wash cycle

The Extra Wash cycle automatically pre-washes the laundry and advances into the Normal wash cycle. (The washer does not need to be reset after the Super Wash cycle.) Use this 18-minute cycle when washing heavily soiled loads that need maximum soil removal.

- For proper cleaning, use double the amount of detergent recommended for a wash cycle.

Using Rinse and Spin

When using extra detergent for heavily soiled clothes, or washing special-care items, you may want an extra rinse and spin.

1. Push in Cycle Control Knob and turn clockwise to Rinse, as illustrated.
2. Pull out Cycle Control Knob. The washer fills to selected load size, agitates, drains, and spins.

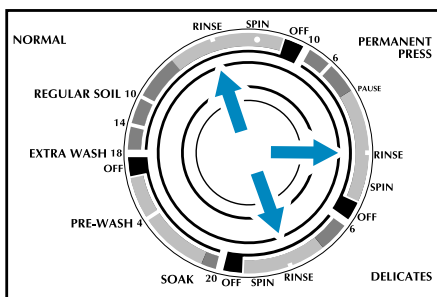

Using Drain and Spin

A drain and spin may help shorten drying times for some heavy fabrics or special-care items by removing excess water.

1. Push in Cycle Control Knob and turn clockwise to Spin, as illustrated.
2. Pull out Cycle Control Knob. The washer drains and then spins.

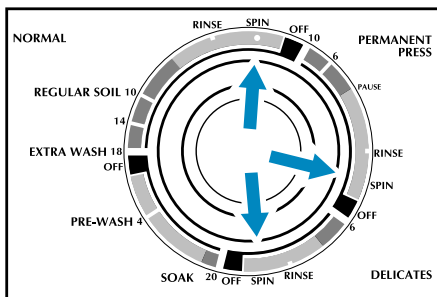

What happens in each cycle

When the Cycle Control Knob is set to a number and pulled out, the washer fills (to the selected water level) before agitation and timing start. The washer begins agitating immediately after filling; agitation can occur with the washer lid up or down. After agitation starts, the Cycle Control Knob turns clockwise until it points to Off and the cycle ends.

The washer pauses briefly throughout each cycle. These pauses are normal for washer operation.

NOTE: A Gentle Wash system helps protect your fabrics by reducing wash agitation speed during the last few minutes of wash agitation in the Normal and Permanent Press cycles.

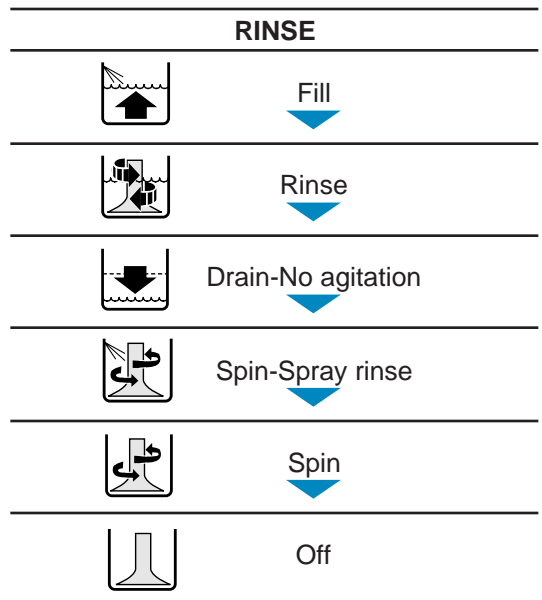
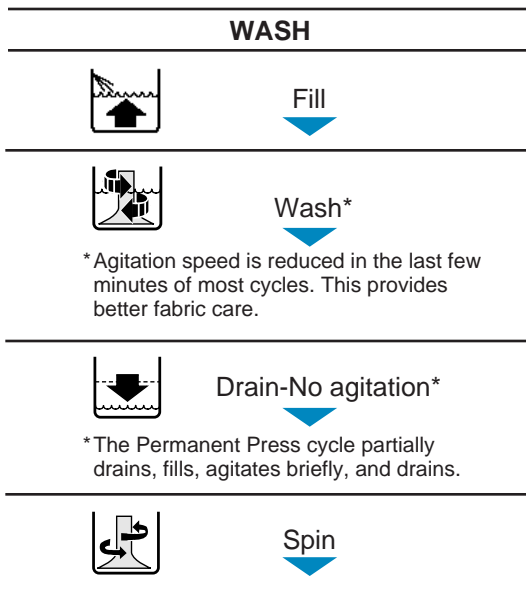

Self-cleaning lint filter

The lint filter at the bottom of the washer basket cleans itself. During agitation, wash and rinse water passes over the filter, separating the lint from the water. The lint is then spun away from the filter and out of the system during the spin part of the cycle.

If your washer drains into a tub, remove any lint collected in the tub or strainer.

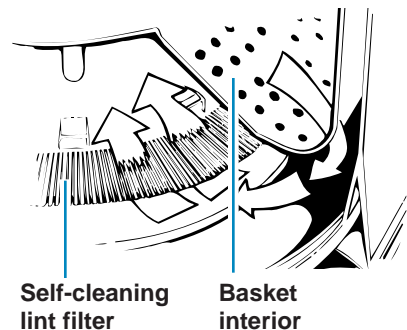

Adding liquid chlorine bleach

Always measure liquid chlorine bleach. **Do not guess. Never use more than 1 cup (250 mL) for a full load.** Use less with lower load size settings. Follow manufacturer's directions for safe use. Use a cup with a pouring spout to avoid spilling.

1. Let the washer fill and begin agitating the load.
2. Add bleach to wash cycle so it can be removed in the rinse cycle. Pour bleach around agitator, not directly on load.
 - Follow directions on care labels. Do not use chlorine bleach on wool, silk, spandex, acetates, or some flame-retardant fabrics.

- When soaking with chlorine bleach, add detergent to soak water.

NOTE: Undiluted bleach will damage any fabric it touches. The damage appears as rips, holes, tears, or color loss and may not show up until several washings later.

Adding liquid fabric softener

NOTE: Your washer does not come with a fabric softener dispenser installed.

To order the fabric softener dispenser (Part# 3350834), contact the store where you purchased your washer/dryer.

- Always dilute liquid fabric softener with $\frac{1}{2}$ to 1 cup (125 to 250 mL) warm water. Undiluted fabric softener can stain fabrics.
- Add diluted fabric softener only in the final rinse.
- Fabric softener should not be mixed with other laundry products because greasy stains may form. If stains form, remove by wetting the stain and rubbing with liquid detergent or a bar of soap. Rewash the stained item.
- Too much fabric softener can make some items (diapers and towels) nonabsorbent. If this happens, use less fabric softener or do not use it every time.

Operating Your Dryer

The information in this section helps you learn to use your dryer efficiently and safely. Refer to the “Laundry Tips” section for additional information on sorting, loading, and drying most types of washables.

NOTE: Before using your dryer, wipe the dryer drum with a damp cloth to remove dust from storing and shipping.

⚠ WARNING



Explosion Hazard

Keep flammable materials and vapors, such as gasoline, away from dryer.

Do not dry anything that has ever had anything flammable on it (even after washing).

Failure to follow these instructions can result in death, explosion, or fire.

⚠ WARNING



Fire Hazard

No washer can completely remove oil.

Do not dry anything that has ever had any type of oil on it (including cooking oils).

Items containing foam, rubber, or plastic must be dried on a clothesline or by using an Air Cycle.

Failure to follow these instructions can result in death or fire.

Starting your dryer

1. Load clothes into the dryer and close the door.



2. Turn the Cycle Control Knob to the desired cycle and setting. Use the Energy Preferred Automatic Setting (*) to dry most loads. See “Selecting a cycle and setting” for descriptions of the cycles.



3. Push the Start button.



NOTE: Your dryer stops automatically when a cycle ends.

Stopping/restarting your dryer

You can stop your dryer anytime during a cycle.

To stop the dryer, either:

- Open the dryer door



OR

- Turn the Cycle Control Knob to Off.

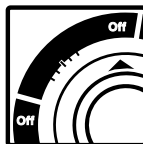

NOTE: The Cycle Control Knob should point to an Off area when the dryer is not in use.

To restart the dryer:

1. Close the dryer door.
2. Select a new cycle, if desired.
3. Push the Start button.

Selecting a cycle and setting

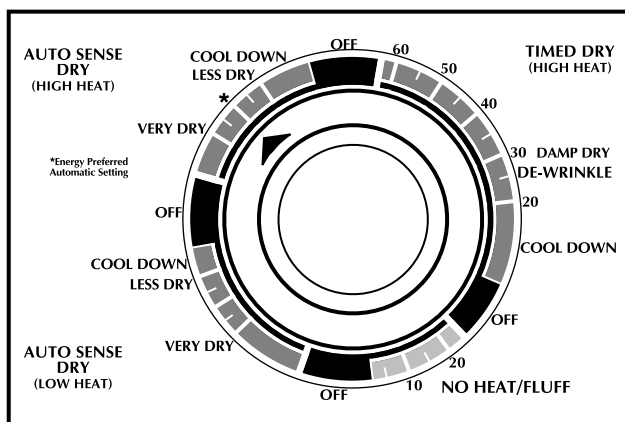

Your dryer's Cycle Control Knob is shown above. Use the drying guidelines and cycle descriptions on this and the following pages for help in selecting the right drying cycles.

- Always follow care label directions when they are available.
- To dry delicate fabrics, rubber, plastic, and heat-sensitive fabrics, always use the No Heat/Fluff cycle or dry these items on a line or rack.
- The last few minutes of all cycles are without heat to make the load easier to handle.
- To help reduce wrinkling, remove the load from the dryer as soon as tumbling stops. This is especially important for permanent press, knits, and synthetic fabrics.

- Overdrying can cause shrinkage, static cling, and damage to some fabrics.
- See the "Laundry Tips" section for information about:
 - sorting clothes for drying
 - choosing load sizes
 - using dryer fabric softeners
 - drying special-care items

Cycle Descriptions

Auto Sense Dry Cycle(s)

Dry most loads using the Energy Preferred Automatic Setting (*). Your Auto Sense Dry cycle(s) shuts off when the selected dryness is reached. The Cycle Control Knob will not move until the load is almost dry. After the cool-down, the Knob automatically turns to an Off area and tumbling stops.

- If the load is drier than you like, select Less Dry the next time you dry a similar load.
- If the load is not as dry as you like, complete drying using the Timed Dry cycle. Select Very Dry the next time you dry a similar load.

Your dryer has both a High Heat cycle (Auto Sense Dry or Timed Dry) and a Low Heat cycle (Auto Sense Dry). Refer to the Drying chart within the “Operating Your Dryer” section to guide you when making drying selections.

NOTE: The Auto Sense Dry cycles use an automatic dryness control that senses the exhaust temperature and determines the dryness of the load.

Timed Dry Cycle

Your dryer offers High Heat in the Timed Dry cycle. Use the Timed Dry cycle to complete drying if some items are damp after using an Auto Sense Dry cycle. Timed Dry is also useful for:

- Bulky items and large loads that require a long drying time.
- Damp drying items; turn the Cycle Control Knob to 30 minutes or less.

Refer to the Drying chart within the “Operating Your Dryer” section for Timed Drying suggestions.

Damp Dry Feature

Use this feature to dry items to damp level or to dry damp items that do not require an entire drying cycle. Two examples are heavy cottons, such as jeans, which you do not want to become stiff, or cotton clothes which are easier to press when damp.

De-Wrinkle Feature

The De-Wrinkle feature removes wrinkles from clothes that have been packed in a suitcase, or from items not removed from the dryer at the end of a cycle. Put only a few items in your dryer for best results when using this cycle. As soon as the dryer stops, fold or put the items on hangers.

No Heat/Fluff Cycle

The No Heat/Fluff cycle has no heat. Use this unheated cycle to fluff or air dry bedding, plastic tablecloths, foam pillows, etc. Refer to the Drying chart within the “Operating Your Dryer” section for more information.

Drying chart

Use the chart below and the one on the next page to guide you when making drying selections. The charts suggest settings and drying times for various loads.

- The check mark (✓) denotes recommended temperature settings. If some types of loads in the chart have more than one suggested temperature setting, choose the setting according to fabric type.

- Always follow care label directions when they are available, especially for delicate items.

TYPE OF LOAD	AUTOMATIC CYCLES (heat settings)		TIMED DRY CYCLE (minutes)
	Auto Sense Dry (High Heat)	Auto Sense Dry (Low Heat)	(High Heat)
COTTONS AND LINENS Extra Heavy Bedspreads, mattress pads, quilts Heavyweight Towels, jeans, corduroys, work clothes Mediumweight Sheets, cotton underwear, diapers Lightweight Batistes, organdies, lingerie	✓ ✓ ✓	✓ ✓	40-50 30-40 20-30 10-20*
PERMANENT PRESS, SYNTHETICS, AND BLENDS Heavyweight Work clothes, jackets, raincoats Mediumweight Shirts, play clothes, sheets, slacks Lightweight Lingerie, blouses, dresses	✓ ✓	 ✓	20-30 10-20 10-20*
KNITS Heavyweight Cottons, rayons, blends, T-shirts, slacks, shirts Mediumweight Synthetics (polyester, acrylic, etc.), dress slacks, skirts, sweaters Lightweight Synthetics (polyester, acrylic, etc.) and blends, lingerie, blouses, dresses	✓ ✓	 ✓	20-30 10-20 10-20*

* To remove moisture from clothing, use 10 minutes High Heat then No Heat/Fluff, or use No Heat/Fluff only.

No Heat/Fluff cycle

The chart below includes examples of items that require drying without heat. Use the No Heat/Fluff cycle, or place the items on a line or rack to air dry.

NOTES:

- Line dry bonded or laminated fabrics.
- Always follow care label directions when they are available.

TYPE OF LOAD	NO HEAT/FLUFF CYCLE* (minutes)
DELICATE FABRICS Sheer curtains (two or three panels), gauze, lace, etc.	10-20
RUBBER, PLASTIC, HEAT-SENSITIVE FABRICS Foam Rubber – Pillows, padded bras, stuffed toys <ul style="list-style-type: none"> • Make sure coverings are securely stitched. • Shake and fluff pillows by hand several times during the No Heat/Fluff cycle. • Make sure pillows are completely dry. Foam rubber pillows take a long time to dry. Plastic – Shower curtains, tablecloths Rubber-backed rugs Olefin, Polypropylene, Sheer nylon	20-30 20-30 40-50 10-20

* Reset cycle as needed to complete drying.

End of cycle signal

The dryer sounds a signal to let you know when the cycle is finished. The signal is helpful when you are drying permanent press, synthetics, and other items that should be removed from the dryer as soon as it stops. The signal can be turned On or Off.

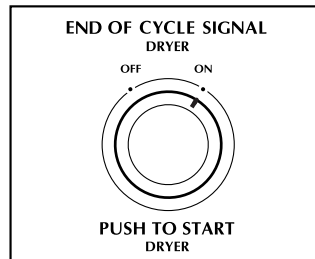

Laundry Tips

This section provides information on preparing clothes for laundering, removing stains, and handling special-care items.

Sorting clothes

- Separate dark from light colors; colorfast from noncolorfast. Items properly sorted for washing are usually properly sorted for drying.



- Separate lint givers (towels, chenille) from lint takers (corduroy, synthetics, permanent press). When possible, turn lint takers inside out.

- Separate heavy fabrics (denim, towels) from light fabrics (synthetics, permanent press).

Choosing load sizes

- Mix large items with smaller items. Load the washer or dryer by the amount of space items take up, not by their weight. Overcrowding causes poor cleaning, uneven drying, and wrinkling, and can cause items to wear out faster (because of pilling).
- You may need to rearrange large items (sheets, blankets, tablecloths) during a cycle to reduce balling or rolling up.



- For better tumbling action, when drying only a few small items, add one or two lint-free towels. This also prevents small, lightweight items from blocking airflow.
- To reduce wrinkling when washing, permanent press and synthetic knits should have more room to move in the water than heavy items (towels, jeans).

Washing and drying tips

- Close zippers, snaps, and hooks to avoid snagging other items. Remove heat-sensitive trim that can be damaged by drying. Tie strings and sashes so they will not tangle.
- Check garments to make sure all spots and stains were removed during the wash. Do not tumble dry soiled or stained items. Heat may permanently set stains.



- Sharp or metal objects can damage your washer interior or dryer drum. Check pockets for pins, clips, money, bolts, nuts, etc. Do not lay these objects on your washer or dryer after emptying pockets. Turn pockets of heavy items inside out for even drying.
- Place small items such as baby socks or hankies in a mesh bag for easier removal.
- Articles to be ironed should be removed from the dryer while still damp.



Using dryer fabric softeners

Dryer fabric softeners are recommended for reducing static cling and for softening fabrics. Always follow package instructions carefully. Use fabric softeners labeled as dryer safe.

- Put one fabric softener sheet on top of the load **before starting the dryer**. Do not add a fabric softener sheet **after** the drying cycle has started. Instant heat can cause the fabric softener to spot fabrics.

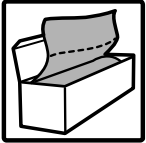

- Remove fabric softener stains by wetting the stains and rubbing them with liquid detergent or bar soap and rewash.
- Some fabric softeners may cause a build-up on the lint screen. See “As needed cleaning – dryer.”

Water guidelines

Washer loading suggestions

For these suggested full-sized loads, use the highest water level setting.

LARGE CAPACITY WASHERS			
Heavy Work Clothes 2 pairs pants 3 shirts 3 pairs jeans 1 coverall	Knits 2 slacks 2 blouses 4 shirts 4 tops 2 dresses	Mixed Load 2 double or 1 king size sheet 4 pillowcases 6 T-shirts 6 pairs shorts 2 shirts 2 blouses 6 handkerchiefs	Permanent Press 1 double sheet 1 tablecloth 1 dress 1 blouse 2 slacks 3 shirts 2 pillowcases
Towels 8 bath towels 8 hand towels 10 wash cloths 1 bath mat	Delicates 2 camisoles 4 slips 4 panties 2 bras 2 nighties		

Selecting water temperatures

WASH WATER TEMPERATURE*	SUGGESTED FABRICS	COMMENTS
HOT 130°F (54°C) or above	<ul style="list-style-type: none"> • Work clothes • Sturdy whites/colorfast pastels • Diapers 	<ul style="list-style-type: none"> • Best cleaning for heavily soiled items • Removes oils, perspiration, greasy soils, and stains • Prevents graying or yellowing
WARM 90-110°F (32-44°C)	<ul style="list-style-type: none"> • Dark/noncolorfast colors • Permanent press items • Nylon, polyester, acrylics, silks, woolens • Knits/delicate fabrics 	<ul style="list-style-type: none"> • Best for lightly soiled to moderately soiled items • Safe for most fabric finishes • Less fading and dye bleeding • Reduces wrinkling
COLD 70-90°F (21-32°C)	<ul style="list-style-type: none"> • Extra-sensitive colors • Noncolorfast items • Hand washables 	<ul style="list-style-type: none"> • Best for very lightly soiled items • Saves hot water • Best rinse water temperature

* The washer features cold rinses for all wash temperatures.

Checking hot water temperature

Your hot water should be 130°F (54°C) or above. If you do not know your hot water temperature, you can check it easily. You may need to raise the temperature of your water heater. To check your hot water:

1. Fill a pan with the hottest water available from the faucet that fills your washer.
NOTE: If you do not have a faucet at your washer site, collect the water from the faucet closest to your washer.
2. Place a candy thermometer or cooking thermometer in the water to check the temperature.

NOTE: In wash water temperatures colder than 70°F (21°C), detergents do not dissolve well. Also, soils may be difficult to remove, and some fabrics may retain wear wrinkles and may have increased pilling.

Water hardness

Many poor washing results can be traced to the hardness of the wash water. To check your water hardness:

- City water – ask the city water company.
- Well water – ask the local water authority.

Ask for the mineral content in grains/gallon or parts/million. If your water is more than 8 grains/gallon or more than 137 parts/million, you should consider:

- Installing a water softener.
- Using more detergent.
- Using a packaged water conditioner.
- Not using soap.

Removing stains

Stained, heavily soiled, or greasy items may need to be prewashed or soaked for best results. Soaking helps remove protein-type stains like blood, milk, or grass. Prewashing helps loosen soil before washing.

Stain removal rules

- Use warm water for soaking or prewashing stained laundry. Hot water can set stains.
- Most stains are easier to remove when they are fresh. Old or set stains may not come out. Follow package directions for pretreatment products.
- Before treating any stain, find out what kind of stain it is, how old the stain is, what kind of fabric it is, and if the fabric is colorfast. (Check the care label.)
- Washing and drying can set some stains.
- Start with cold or warm water. Hot water can set some stains.
- When bleach is recommended, use a bleach that is safe for the fabric.
- Test stain removers on an inside seam or hidden corner of the item to see if the color is removed.
- Put the stained area face down on a paper towel or white cloth. Apply the stain remover to the back of the stain. This forces the stain off the fabric instead of through it.
- Meat tenderizer or enzyme presoaks help break down some protein stains so they are easier to remove.

Stain removal guide

STAIN	TO REMOVE
Alcoholic beverage	These stains turn brown with age, so treat immediately. Sponge or soak fresh stains with cold water. Wash. If stain remains, soak 15 minutes in a solution of lukewarm water, liquid detergent, and a few drops of white vinegar. Rinse. Wash.
Blood	Rinse immediately or soak in cold water with enzyme presoak for 30 minutes or longer. Rinse. Rub detergent into any remaining stains. Rinse. If stain remains, put a few drops of 3% hydrogen peroxide on stain for 3-5 minutes. Rinse thoroughly. Wash.
Chewing gum	Use ice to make gum hard. Scrape off what you can. Sponge with a nonflammable fabric cleaner. Let dry. Wash.
Chocolate or coffee	Sponge immediately with a nonflammable fabric cleaner or apply a prewash soil and stain remover. Rinse. Wash. If stain remains, apply a liquid detergent to stain or soak in warm water with an enzyme presoak. Rewash.
Crayon and candle wax	Scrape off excess with a dull knife. Place fabric between two blotters or facial tissue. Press with warm iron. Remove color stain with nonflammable fabric cleaner. Hand wash until stain is gone. If full load is crayon stained, take to cleaners or coin-operated dry cleaning machine.
Cream, milk, or ice cream	Sponge with a nonflammable fabric cleaner, or a prewash soil and stain remover. Rinse. Wash. Repeat if necessary. If stain remains, apply a few drops of liquid detergent and a few drops of ammonia. Blot dry and rinse. If stain remains, soak in an enzyme presoak. Wash.

continued on next page 23

LAUNDRY TIPS

STAIN	TO REMOVE
Deodorants and anti-perspirants	Light stain: Treat with liquid detergent or your regular laundry detergent. Wash in hottest water safe for fabric.
	Heavy stain: Place face down on towel and treat with a paste of ammonia and color safe bleach. Let stand for 30 minutes. Wash in hottest water safe for fabric.



⚠ WARNING

Fire Hazard

No washer can completely remove oil.

Do not dry anything that has ever had any type of oil on it (including cooking oils).

Doing so can result in death or fire.

Fat, grease, or oil	<p>Items soiled with vegetable or cooking oil should not be washed or dried. For other types of greasy stains, use one of the methods below:</p> <ul style="list-style-type: none"> • Use pretreatment stain remover. Follow label directions. Wash in hottest water safe for fabric. • Use talcum powder to absorb as much grease as possible. Sponge with a nonflammable fabric cleaner. Rinse. Wash. • Treat with liquid detergent or rub a detergent paste on the stain. Wash using hottest water safe for fabric.
Fruit stains	<p>Fresh stains: Soak immediately in cool water. Wash. If stain remains, cover area with a paste made of color safe bleach, a few drops of hot water, and a few drops of ammonia. Wait 15-30 minutes. Wash.</p> <p>Old stains: Sponge with white vinegar. Rinse. Repeat procedure for fresh stains.</p>
Grass or green vegetables	Soak in warm or cold water with an enzyme presoak for at least 30 minutes, or sponge with denatured alcohol. Wash in water temperature and bleach safe for the fabric. For colored fabrics, check colorfastness before applying alcohol. For acetate, sponge with a nonflammable fabric cleaner. If stain remains, bleach with 3% hydrogen peroxide. Rinse. Rewash.
Ink or ballpoint pen ink	Spray stain with an aerosol hair spray or rubbing alcohol. Sponge stain continuously until all bleeding stops. Let dry. Repeat if necessary. Wash. If stain remains, bleach, if safe for fabric. (India and other indelible inks are almost impossible to remove completely.)
Iron or rust	<p>Colored or noncolorfast items: Apply lemon juice and salt. Place in the sun to dry. Rinse thoroughly. Repeat if necessary.</p> <p>White or colorfast items: Try a rust remover. Test first on inside seam or hem. Some rust removers are not washer safe. Follow package directions.</p>

STAIN	TO REMOVE
Ketchup or tomato products	Sponge immediately with a nonflammable fabric cleaner or apply a prewash soil and stain remover. Rinse. Wash. If stain remains, apply a liquid detergent to stain or soak in warm water with an enzyme presoak. Rewash.
Lipstick	Apply nonflammable fabric cleaner or prewash soil and stain remover. Blot with absorbent material. Repeat if necessary. Rinse. If stain remains, rub with liquid detergent. Wash.
Meat juice, egg	Scrape off excess with a dull knife. Soak in cold or warm water with enzyme presoak at least 30 minutes, or treat stains with a nonflammable fabric cleaner. Wash.
Mildew	Wash in hottest water safe for fabric. If stain remains, soak in warm water and a color safe bleach for 15-30 minutes. Rewash. (Old mildew stains are almost impossible to remove. Mildew fungus destroys or weakens fabrics.) An alternative to bleach is to treat with salt and lemon juice and dry in direct sunlight. Rinse and rewash. Mildew may form if wet or damp laundry remains in your washer for extended periods of time. To prevent mildew, promptly dry laundry after washing.
Mustard	Treat immediately. Scrape off excess mustard. Sponge with a nonflammable fabric cleaner or a prewash soil and stain remover. Rinse. Work liquid detergent and a few drops of vinegar into stain. Rinse. If stain remains, apply 3% hydrogen peroxide. Rinse and wash.
Paint	Hand wash paint-stained items. Water base: Treat stains while still wet. (These paints cannot be removed after they have dried.) Rinse in warm water to flush out paint. Sponge with a nonflammable fabric cleaner. Rinse. Wash. Oil base: Scrape off fresh paint. Sponge with a nonflammable fabric cleaner. While stain is still wet with solvent, rub liquid detergent into it. Wash with hottest water safe for fabric.
Perspiration	Remove stains before ironing. Perspiration stains may weaken fabric. Wash or sponge stain thoroughly with detergent and warm water. If perspiration has changed the color of the fabric, use one of the following treatments: Fresh stains: Apply ammonia to stain. Rinse. Launder to remove ammonia odor. Old stains: Apply white vinegar to stain. Rinse. Launder to remove vinegar odor.
Scorch	Severe scorch cannot be removed. Wet stain with 3% hydrogen peroxide. Cover with a dry cloth and press with an iron as hot as is safe for fabric. Rinse well. Wash. OR Wet with lemon juice and spread in the sun to dry. Wash.
Soft drinks	Sponge immediately with cold water and alcohol. Heat and detergent may set stain.

Washing special-care items

Most garments and household textiles have care labels with laundering instructions. **Always follow care label directions when they are available.** Below are general washing instructions for some special washables.

ITEM	CARE INSTRUCTIONS
Blankets (electric or woolen)	Pretreat spots and stains. Select water temperature, cycle, and time according to the type of blanket being washed. An extra rinse may be necessary (see "Using Rinse and Spin"). Check care label to see if manufacturer recommends machine washing.
Curtains, drapes, slipcovers	Wash small loads. Crowding may cause wrinkling. Replace slipcovers while still slightly damp. They will dry to fit tightly. NOTE: Sun-damaged curtains and draperies will tear whether hand or machine washed.
Diapers	When using chlorine bleach for soaking, add extra detergent to the load. Avoid overuse of fabric softeners – absorbency will be reduced.
Elastic, spandex	Elastic picks up oil from the body. Oil can damage elastic. Wash often to reduce the damage. Use warm water and sufficient detergent to remove oils. Do not use chlorine bleach.
Flame-retardant clothing	Items will be clearly labeled as flame-retardant. Follow manufacturer's instructions to retain flame-retardant qualities.
Knits, washable	Knits are comfortable to wear because they stretch. However, this means that knits are more likely to be stretched and damaged when washed (especially bulky knits). Knits made of synthetic fabrics such as polyester, nylon, and acrylic tend to keep their original shape more than a knit made of cotton or ramie.
Pillows, stuffed toys	Washing feather pillows is not recommended unless they will be dried in a dryer.
Plastic, rubber items	Treat as delicate items. Wash in warm water. Wash small items in a mesh bag.
Quilts, bedspreads	Do not wash cotton-filled comforters unless they are quilted or stitched. Tucked cotton batting tends to slip and become lumpy. An extra rinse may be necessary.
Scatter rugs	Shake or vacuum rugs to remove loose dirt. Wash more than one rug at a time. If washing only one rug, add bath towels to balance the load.
Snowsuits, jackets	Wash only one or two items at a time. You may need to stop the washer occasionally to press air from the items being washed. An extra rinse may be necessary.

Drying special-care items

Most garments and household textiles have manufacturer's care labels with laundering instructions. **Always follow care label directions when they are available.** The Drying chart in the "Operating Your Dryer" section includes drying instructions for most types of washables. The chart below provides drying instructions for special-care washables.

ITEMS	DRYING INSTRUCTIONS
<p>Blankets and woolens</p> <ul style="list-style-type: none"> • Cotton, rayon, synthetic blankets • Electric blankets, electric sheets, woolen blankets, washable woolen garments 	<p>Machine drying knitted woolens is not recommended. Block to shape when wet and allow to air dry. Line dry blankets in shade on a breezy day over two lines. Pin edges together and straighten them. When partly dry, turn the blanket over, repin, and restraighten. When dry, brush nap.</p> <p>Dry as recommended for permanent press fabrics. Refer to the Drying chart in the "Operating Your Dryer" section.</p> <p>If manufacturer recommends machine drying:</p> <ol style="list-style-type: none"> 1. Place one or two dry towels in the dryer and preheat three to five minutes on a high setting. This will dry blankets faster and help avoid pilling. 2. Put blanket in dryer with warm towels. Set control for 20 minutes. 3. Check after 10 minutes. Remove when still damp. Overdrying and long tumbling can cause shrinking and pilling. 4. Place blanket on flat surface or over two lines to finish drying. Gently stretch to original size and shape. 5. When completely dry, brush gently to raise nap. Press binding with cool iron if needed.
<p>Curtains, slipcovers</p> <ul style="list-style-type: none"> • Draperies, slipcovers 	<p>Remove drapery weights and hooks before laundering. For slipcovers, replace while still slightly damp. They will dry to fit tightly.</p> <p>Dry only a few minutes.</p> <ol style="list-style-type: none"> 1. Leave room in dryer for load to fluff. 2. Remove from dryer while slightly damp. Do not overdry.
<p>Diapers, baby clothes</p>	<p>Wash and dry small items in a mesh bag or pillowcase for convenient handling.</p> <p>Remove diapers and cotton knit items while still slightly damp. They will feel softer, shrink less, and be easier to fold.</p>
<p>Elastic items</p>	<p>Remove from dryer while still slightly damp.</p>
<p>Flame-retardant clothing</p>	<p>Some items have been treated with a flame-retardant finish to improve their resistance to burning. Such items are clearly labeled. To retain flame-retardant qualities through continuous use and washing, clean and dry according to the manufacturer's instructions.</p>

continued on next page

LAUNDRY TIPS

ITEMS	DRYING INSTRUCTIONS
Knits, washable	Do not overdry knits. Overdrying can cause shrinking and static cling. <ol style="list-style-type: none">1. Select cycle according to fabric and construction.2. Turn synthetics and blends inside out when drying to avoid pilling.3. Remove cotton and rayon knits while still slightly damp. Stretch into shape and lay flat to finish drying.
Napped items <ul style="list-style-type: none">• Corduroy, velveteen	Dry separately or with similar colors to avoid lint transfer. Follow care label instructions. <ol style="list-style-type: none">1. Remove from dryer while there is still a trace of moisture.2. Smooth, reshape, and air dry before putting away.
Quilted, down-filled items	Follow care label instructions. <ol style="list-style-type: none">1. Dry one at a time.2. Remove from dryer and shake or fluff the item during the drying cycle.3. Smooth and reshape before putting away.
Snowsuits, jackets <ul style="list-style-type: none">• Nylon or polyester	Check label for fiber content, then follow care label instructions. <ol style="list-style-type: none">1. Dry garment for about 10 minutes. Remove and turn inside out. Dry for 10 more minutes.2. Remove from dryer immediately and hang on a nonrusting hanger to finish drying. This will help eliminate wrinkles.

Caring for Your Washer/Dryer

Proper care of your washer/dryer can extend its life. This section explains how to care for your washer/dryer properly and safely.

Every load cleaning – dryer

Cleaning the lint screen

The lint screen is located at the front of the dryer door opening. **Clean it before each load.** A screen blocked by lint can increase drying time.

1. Open the door and pull the lint screen straight up.

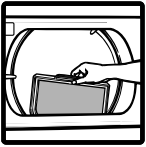

2. Roll lint off the screen with your fingers. Do not rinse or wash the screen to remove lint. Wet lint is hard to remove.

3. Push the lint screen firmly back into place and close the door.

IMPORTANT:

- Do not run the dryer with the lint screen loose, damaged, blocked, or missing. Doing so can cause overheating and damage to both the dryer and fabrics.
- Some towels made of synthetic fibers and natural fibers (polyester and cotton blends) may shed more lint than other towels, causing your dryer's lint screen to fill up faster. Be sure to remove lint from the lint screen before and after drying new towels.

As needed cleaning – washer

Exterior

Wipe up detergent, bleach, and other spills with a soft, damp cloth or sponge as they occur. Occasionally wipe the outside of the washer to keep it looking like new.



Interior

Clean interior with 1 cup (250 mL) of chlorine bleach mixed with 2 cups (500 mL) of detergent. Run washer through a complete cycle using hot water. Repeat process if necessary.

NOTE: Remove hard water deposits using only cleaners labeled as washer safe.

As needed cleaning – dryer

Exterior

Wipe with a soft, damp cloth.

Interior

Garments which contain unstable dyes, such as denim blue jeans or brightly colored cotton items, may discolor the dryer interior. Even after cleaning, these stains may reappear when similar loads are dried. These stains are **not** harmful to your dryer and will not stain future loads of clothes. It may be helpful to dry unstable dye items inside out to prevent dye transfer.

⚠ WARNING



Explosion Hazard

Use nonflammable cleaner.

Failure to do so can result in death, explosion, or fire.

To clean dryer drum:

1. Make a paste with powdered laundry detergent and very warm water.
2. Apply paste to a soft cloth and scrub area until all excess dye is removed.



OR

Apply a liquid, non-flammable household cleaner to the stained area and rub with a soft cloth until all excess dye is removed.

3. Wipe drum thoroughly with a damp cloth.
4. Tumble a load of clean cloths or towels to dry drum.

Clogged lint screen

Laundry detergents and fabric softeners can cause a residue buildup on the lint screen. Clean the lint screen with a nylon brush every six months or more frequently if it becomes clogged due to a residue buildup.

Use the following method:

1. Wet both sides of lint screen with hot water.
2. Wet a nylon brush with hot water and liquid detergent; scrub lint screen with the brush to remove residue buildup.

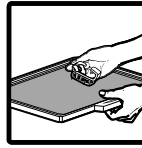

3. Rinse screen with hot water.
4. **Thoroughly** dry lint screen with a clean towel; replace in dryer.

Removing accumulated lint from inside the dryer cabinet

Lint can gather inside the dryer and be a fuel for fire. Lint should be removed every two to three years, or more often, depending on dryer usage. Cleaning should be done by a qualified person. If you need more information, please call our Consumer Assistance Center at **1-800-253-1301**.

⚠ WARNING



Electrical Shock Hazard

Disconnect power before cleaning.
Replace all panels before operating.
Use two or more people to move washer/dryer.
Failure to do so can result in death, electrical shock, or other injury.

1. Unplug washer/dryer or disconnect power.
2. Remove the rear panel using a hex-head screwdriver.
3. Remove any lint using a vacuum cleaner or soft brush. Avoid damaging wires and thermostats.
4. Replace rear panel.
5. Level the washer/dryer if necessary.
6. Plug in washer/dryer or reconnect power.

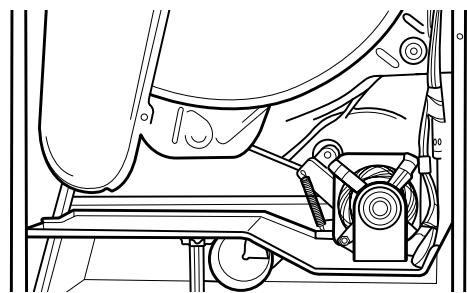

Dryer with rear panel removed

Winter storage or moving care

Install and store your washer/dryer where it will not freeze. Because some water may stay in the hoses, freezing can damage your washer/dryer. If storing or moving your appliance during freezing weather, winterize it.

To winterize or move washer:

1. Shut off both water faucets.
2. Disconnect and drain water inlet hoses.
3. Put one quart (1L) of R.V.-type antifreeze in the basket.
4. Unplug the power supply cord.

NOTE: If you are moving, run washer on a drain and spin setting (see “Using Drain and Spin”) for about 30 seconds to mix the antifreeze and water.

To use washer again:

1. Flush water pipes and hoses.
2. Reconnect water inlet hoses.
3. Turn on both water faucets.
4. Reconnect power supply cord.
5. Run the washer through a complete cycle with one cup (250 mL) of detergent to clean out antifreeze.

Non-use or vacation care

Operate your washer/dryer only when you are at home. If you will be on vacation or will not be using your washer/dryer for an extended period of time, you should:

- Unplug the power supply cord or turn off electrical power to the washer/dryer.
- Turn off the water supply to the washer. This helps avoid accidental flooding (due to a water pressure surge) while you are away.

Saving energy

Washer

- Use warm or cold wash water for most loads. Use hot water only when washing heavy, greasy soils or whites.
- Wash full loads.
- Avoid rewashing. Use enough detergent and pretreat stains or heavy soils. Use the cycles and wash times recommended for the fabric and soil.
- Use your washer during off-peak hours – usually early morning and late evening. (Ask your power company for details.)

Dryer

- Use an Automatic cycle to dry most loads.
- Dry only full loads without overdrying.
- Avoid overloading dryer, adding wet items to a partly dried load, or opening the door unnecessarily.
- Plan your laundry to dry one load after another. A warm dryer shortens drying time.
- Shorten drying times by exhausting dryer properly and cleaning exhaust vent and outside exhaust hood as needed.
 - Keep the lint screen clean.
 - Use your dryer in a room where room air temperature is above 45°F (7°C).
 - Sort loads by fabric weight and type.

Troubleshooting

Most laundering problems are easily solved if you understand the cause. Check the following lists for **laundry** problems you may have and their possible causes. Also refer to “Common washer/dryer problems” within this section for a **washer/dryer** checklist which can help you solve some simple problems without calling for service. If you still need help, see the “Requesting Assistance or Service” section.

Common laundry problems – washer

PROBLEM	CAUSE
Brown, yellow stains	<ul style="list-style-type: none">• Chlorine staining• Iron in water heater or pipes; iron and manganese in water
Dye transfer	<ul style="list-style-type: none">• Improper sorting• Load not immediately removed from washer after end of cycle
Gray whites, dingy colors	<ul style="list-style-type: none">• Improper sorting• Water temperature too low• Not enough detergent• Using soap in very hard water (use detergent in hard water)
Greasy looking spots	<ul style="list-style-type: none">• Fabric softener poured directly on clothes• Not enough detergent or dispenser not used
Lint	<ul style="list-style-type: none">• Improper sorting• Paper or tissue in pockets• Pilling being mistaken for lint• Not enough detergent
Load too wet after spin	<ul style="list-style-type: none">• Cold rinses• Cycle stopped before spinning is complete
Shrinking	<ul style="list-style-type: none">• Fabric type (some knits stretch during manufacturing – laundering returns fabric to original size)• Care label directions not followed
Snags, rips, and holes	<ul style="list-style-type: none">• Items damaged before washing• Misuse of color safe bleach (do not pour directly on clothes); dispenser not used• Sharp items not removed from pockets; fasteners not fastened
Stiff, rough fabrics	<ul style="list-style-type: none">• Using soap in very hard water (use detergent in hard water)• Not enough detergent• Line drying
Twisting/Tangling	<ul style="list-style-type: none">• Overloading• Clothes wrapped around agitator
Wrinkling	<ul style="list-style-type: none">• Overloading (leave more room for permanent press and knits)• Load not immediately removed from washer after cycle• Warm rinse water• Cycle selection incorrect
Yellow areas (from body oils)	<ul style="list-style-type: none">• Water temperature too low• Not enough detergent

Common laundry problems – dryer

PROBLEM	CAUSE
Slow drying or clothes still wet	<ul style="list-style-type: none"> • Incorrect cycle setting selected. • Full or clogged lint screen. (See the “As needed cleaning – dryer” section.) • Exhaust vent clogged, restricted, or too long. (See the “Checking Your Vent ” section and Installation Instructions.) • Washer/dryer located in room with temperature below 45° (7°C). • Load too large and bulky to dry quickly. • Drying heavy fabrics (denim, towels) with light fabrics (synthetics, permanent press). • Fabric softener sheet blocking exhaust grill inside dryer drum.
Lint	<ul style="list-style-type: none"> • Full lint screen. (See the “As needed cleaning – dryer” section.) • Load not properly sorted. • Overdrying, especially synthetic fabrics that cause lint-attracting static electricity. • Load size too big or heavy. • Tissue or paper left in pockets. • Pilling (surface fuzz caused by normal wear and laundering) attracts lint.
Static electricity	<ul style="list-style-type: none"> • Overdrying. • Dryer fabric softener improperly used. See package directions. • Load includes synthetics, synthetic blends, permanent press, and knit fabrics that build up static electricity.
Wrinkling	<ul style="list-style-type: none"> • Overloading. • Overdrying, especially permanent press and synthetic fabrics. • Large items balling or rolling up. • Clothes left in dryer at end of cycle.
Shrinking	<ul style="list-style-type: none"> • Overdrying. • Fabric or garment is not designed for tumble drying. • Dryer settings incorrect for fabric type. • Care label instructions not followed.
Greasy spots/stains	<ul style="list-style-type: none"> • Dryer fabric softener improperly used. Do not add to a warm load. • Drying soiled items.
Color change	<ul style="list-style-type: none"> • Drying dark colors with light colors. • Drying colorfast colors with noncolorfast colors.
Garment damage	<ul style="list-style-type: none"> • Zippers, snaps, and hooks left open. • Strings and sashes not tied to prevent tangling. • Care label instructions not followed.

Common washer/dryer problems

1. Washer/dryer will not start

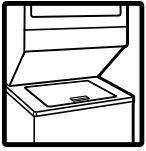

Is the washer lid closed?



OR



Is the dryer door firmly closed?

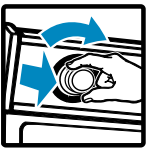

Is the washer Cycle Control Knob set and pulled out?



OR



Are the dryer controls set in an On position?



Did you firmly push the dryer Start Button?

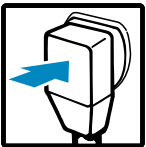

Is the power cord plugged in?



Have you blown a household fuse or tripped the circuit breaker? Electric dryers use 2 household fuses or breakers.

2. Lint accumulation in hood or exhaust vent, or extended drying times

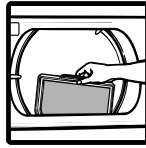

Is the lint screen full?

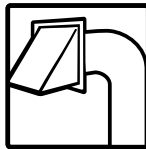

Is exhaust vent or outside exhaust hood clogged with lint? Refer to the "Checking Your Vent" section.

3. No water – washer

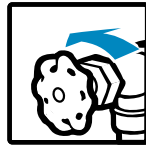

Are both the hot and cold water faucets turned on?



Are the water hoses kinked or clogged?

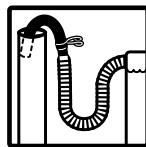

Is the drain hose higher than the water level in the washer? It must be higher for proper operation.

NOTE: Washer stops briefly during a wash cycle. These pauses are normal.

4. No heat – dryer



Have you blown a household fuse or tripped the circuit breaker? Electric dryers use 2 household fuses or breakers.

continued on next page

5. Noises – dryer



If the dryer hasn't been used for awhile, there may be a thumping sound during the first few minutes of operation.

If noises continue, call the Consumer Assistance Center.

6. Odor – dryer



When operating a new dryer, the new electric heating element may have an odor.

Are household chemical odors being drawn into the dryer?

Proper ventilation must be used if painting or staining near the dryer.

NOTE: Store and use paints, varnishes, etc. away from your washer/dryer whenever possible.

If you still have problems, see the "Requesting Assistance or Service" section.

Requesting Assistance or Service

Before calling for assistance or service, please check the “Troubleshooting” section. It may save you the cost of a service call. If you still need help, follow the instructions below.

1. If you need assistance* ...

Call our toll-free number. Dial toll-free from anywhere in the U.S.A.:



1-800-253-1301

and talk with one of our trained consultants. The consultant can instruct you in how to obtain satisfactory operation from your appliance or, if service is necessary, recommend a qualified service company in your area.

2. If you need service* ...

Contact the dealer from whom you purchased the appliance or the authorized servicer in your area. For help finding an authorized service company in your area, call our toll-free telephone number in Step 1.



3. If you need replacement parts ...

To locate replacement parts in your area, refer to step 2 or call our Consumer Assistance Center number in step 1.

Gear case assembly covered by your warranty.

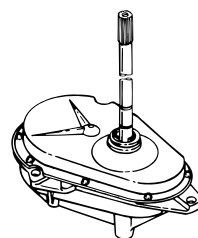

* When asking for help or service:

Please provide a detailed description of the problem, your appliance's complete model and serial numbers, and the purchase date. (See the “A Note to You” section.) This information will help us respond properly to your request.

Combo Washer/Dryer Warranty

LENGTH OF WARRANTY	CROSLEY WILL PAY FOR
FULL ONE-YEAR WARRANTY FROM DATE OF PURCHASE	Replacement parts and repair labor to correct defects in materials or workmanship. Service must be provided by an authorized service company.
LIMITED FIVE-YEAR WARRANTY FROM DATE OF PURCHASE	Replacement parts for any part of gearcase assembly if defective in materials or workmanship. The gearcase assembly is shown in the "Requesting Assistance or Service" section of this book. Replacement parts for any top and lid rust.
LIMITED TEN-YEAR WARRANTY FROM DATE OF PURCHASE	Replacement of outer tub should it crack, or fail to contain water, due to defective materials or workmanship.
CROSLEY WILL NOT PAY FOR	
<p>A. Service calls to:</p> <ol style="list-style-type: none"> 1. Correct the installation of your washer/dryer, including venting. Heavy four-inch metal exhaust vent must be used. Refer to the "Checking Your Vent" section of this Use and Care Guide, and your Installation Instructions. 2. Instruct you how to use your washer/dryer. 3. Replace house fuses or correct house wiring or plumbing. 4. Replace light bulbs. <p>B. Repairs when your washer/dryer is used in other than normal, single-family household use.</p> <p>C. Pickup and delivery. Your washer/dryer is designed to be repaired in the home.</p> <p>D. Damage to your washer/dryer caused by accident, misuse, fire, flood, improper installation (including, but not limited to, venting with plastic or flexible foil), installation not in accordance with local electrical or plumbing codes, acts of God, or use of products not approved by the washer/dryer manufacturer.</p> <p>E. Any labor costs during the limited warranties.</p> <p>F. Repairs to parts or systems caused by unauthorized modifications made to the appliance.</p>	

4/97

CROSLEY SHALL NOT BE LIABLE FOR INCIDENTAL OR CONSEQUENTIAL DAMAGES.

Some states do not allow the exclusion or limitation of incidental or consequential damages, so this exclusion or limitation may not apply to you. This warranty gives you specific legal rights, and you may also have other rights which vary from state to state.

Outside the United States, a different warranty may apply. For details, please contact your authorized distributor or dealer.

If you purchased your washer/dryer in the United States, for use in a foreign country, this warranty does NOT apply.

If you need service, first see the "Troubleshooting" section of this book. After checking "Troubleshooting," additional help can be found by checking the "Requesting Assistance or Service" section, or by calling our Consumer Assistance Center telephone number, **1-800-253-1301**, from anywhere in the U.S.A.

PART NO. 3406874

5/97
Printed in U.S.A.

Free Manuals Download Website

<http://myh66.com>

<http://usermanuals.us>

<http://www.somanuals.com>

<http://www.4manuals.cc>

<http://www.manual-lib.com>

<http://www.404manual.com>

<http://www.luxmanual.com>

<http://aubethermostatmanual.com>

Golf course search by state

<http://golfingnear.com>

Email search by domain

<http://emailbydomain.com>

Auto manuals search

<http://auto.somanuals.com>

TV manuals search

<http://tv.somanuals.com>