

# use & care guide

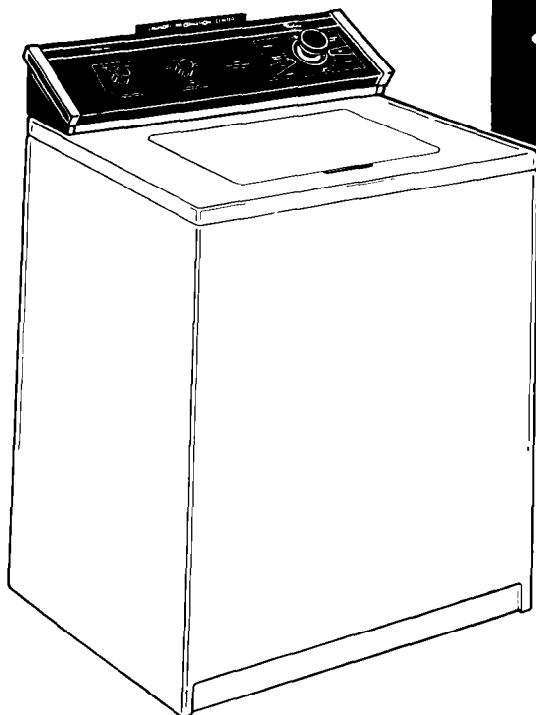

The Whirlpool logo consists of a stylized swirl above the word "Whirlpool" in a serif font.

*Estate* SERIES

**AUTOMATIC  
WASHER**

**Super Capacity  
Model  
LA6380XS**

Microwave Ovens, Trash Compactors, Room Air Conditioners, Dehumidifiers, Automatic Washers, Clothes Dryers, Freezers, Refrigerator-F



# Contents

	Page		Page
<b>PARTS AND FEATURES</b> .....	2	For a Drain and Spin .....	10
<b>IMPORTANT SAFETY</b>		For a Soak .....	10
<b>INSTRUCTIONS</b> .....	3	Liquid Bleach Dispenser .....	11
<b>OPERATING INSTRUCTIONS</b> .....	4	Cleaning the Lint Filter .....	11
Starting Your Washer .....	4	<b>CARING FOR YOUR WASHER</b> .....	12
What Happens in Each Cycle .....	6	Winterizing .....	13
<b>OTHER OPERATING</b>		<b>IF YOU NEED SERVICE OR</b>	
<b>INSTRUCTIONS</b> .....	10	<b>ASSISTANCE</b> .....	14
For a Rinse and Spin .....	10	<b>WASHER WARRANTY</b> .....	16

©1987 Whirlpool Corporation

## Parts and features

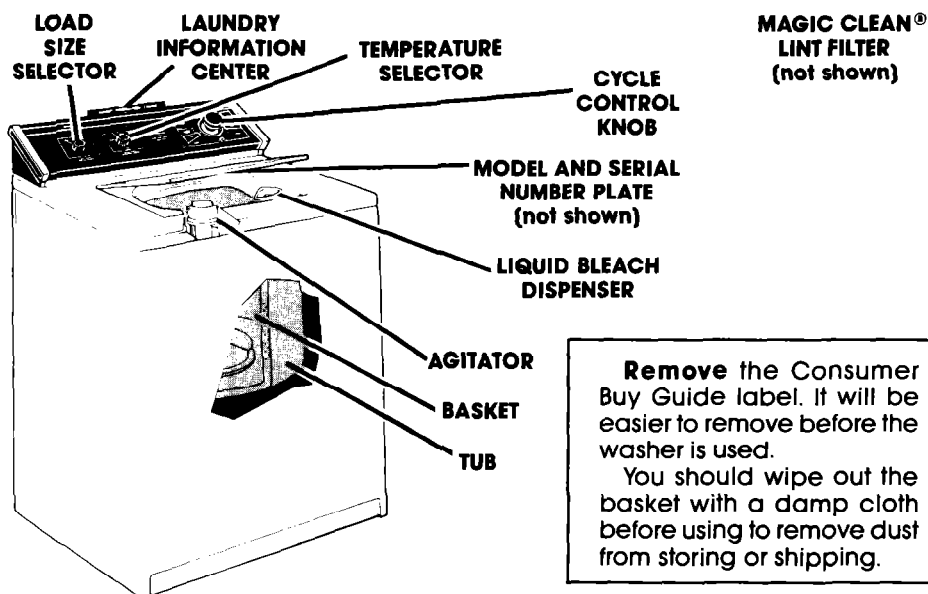

**Remove** the Consumer Buy Guide label. It will be easier to remove before the washer is used.

You should wipe out the basket with a damp cloth before using to remove dust from storing or shipping.

## Copy your Model and Serial Numbers here

When you need service or call with a question, have this information ready:

**1. Complete** Model and Serial Numbers (from plate under the lid near the hinge).

**2.** Purchase date from sales slip.

Copy this information in these spaces. Keep this book, your "Laundry Guide" and sales slip in the Laundry Information Center.

**Please complete and mail the Owner Registration Card furnished with this product.**

\_\_\_\_\_

Model Number

\_\_\_\_\_

Serial Number

\_\_\_\_\_

Purchase Date

\_\_\_\_\_

Service Company  
Phone Number

## Important safety instructions



**WARNING** – To reduce the risk of fire, electric shock, or injury to persons when using your washer, follow basic precautions, including the following:

**Read these Laundry Instructions for important use and safety information before using your washer.**

**NEVER** wash items cleaned, washed, soaked in or spotted with wax, paint, gasoline, or flammable fluids in the washer. The fumes can create a **FIRE HAZARD** or **EXPLOSION**. **ALWAYS** hand launder and air dry fabrics containing these materials.

**NEVER** allow children to operate, play with, or crawl inside the washer. Close supervision of children is necessary when the washer is used near children. When discarding an old washer, **ALWAYS** remove the lid to prevent accidental entrapment.

**NEVER** put your hands into the washer until all motion stops. If the lid is opened while the basket is spinning, the basket will automatically stop in a few seconds.

**DO NOT** tamper with controls.

**NEVER** use or store flammable fluids (dry-cleaning solvents, gasoline, kerosene) in or near your washer. Do not add flammable fluids to the wash water. These substances give off vapors that can create a **FIRE HAZARD** or **EXPLOSION**.

**WARNING:** If hot water has not been used recently (usually two weeks or longer), hydrogen gases may build up in the water heater and the hot water pipes. **HYDROGEN GAS IS EXPLOSIVE**. To prevent injury or damage, before using your washer, turn on all hot water faucets and allow water to run for several minutes. This will allow gases to escape. Do not smoke or use any open flame near the faucet while it is open.

**You are personally responsible for making sure that your washer:**

- is installed, repaired, and parts replaced by a qualified person.
- is properly installed and leveled on a floor that can support the weight.\*
- is connected to the right kind of outlet, electric supply, water supply and drain.\*
- is properly grounded.\*
- is properly maintained.
- is protected from the weather and kept where the temperature will not fall below freezing.

\*See the "Installation Instructions."

– SAVE THESE INSTRUCTIONS –

### Additional Safety Instructions and Your Responsibilities

**ALWAYS** store detergent, laundry aids and other materials in a cool, dry place where children can't reach them – in a locked cabinet if possible.

**ALWAYS** read and follow instructions on packages of detergent and laundry aids – especially warnings and precautions.

**HAZARDOUS FUMES** can be formed if chlorine bleach is used in the same wash as ammonia or acids such as vinegar or rust remover.

**ALWAYS** unplug the power supply cord before attempting to service the washer.

**DO NOT** machine wash glass fiber materials. Small particles can stick to fabrics washed in following loads and cause skin irritation.

**You are personally responsible for making sure that your washer:**

- is used only for jobs normally expected of home automatic washers.
- is not run by children or anyone un-

# Operating instructions



## Starting Your Washer

Be sure to measure and add detergent, then place a sorted load in the washer before starting it.

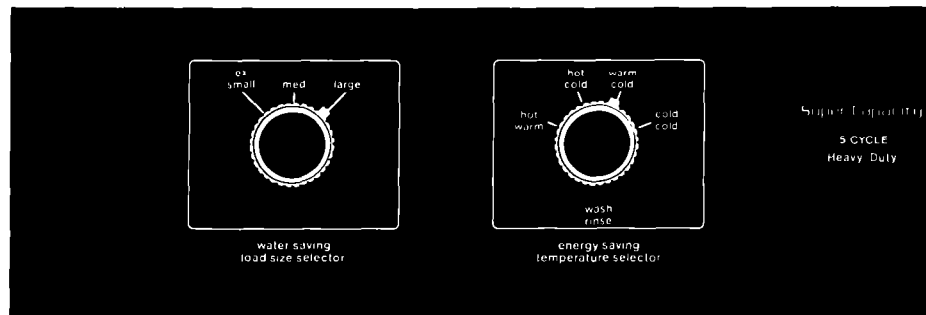

## 1. Select a LOAD SIZE

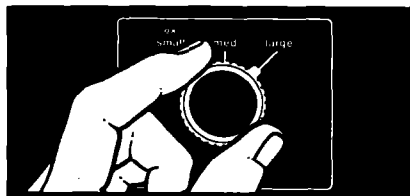

- Turn the knob to point at a setting that describes the size of load you want to wash.
- Set the knob anywhere on or between EX SMALL (a few small items) and LARGE (a full load).

**NOTE: Use the LARGE water level for best permanent press results.**

## 2. Select WATER TEMPERATURES

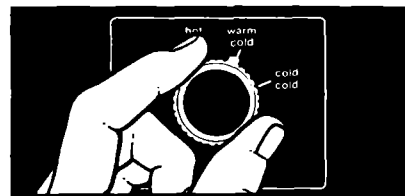

- Match the wash and rinse water temperature to the type of fabrics and soils being washed.

Recommended wash temperatures can be found in your "Laundry Guide."

## LOAD SIZES AND WATER LEVELS

For best cleaning results, the load must be able to move freely in the water. Too big a load or too little water can cause wear or tearing of load items.

\*Approximate fill with load.

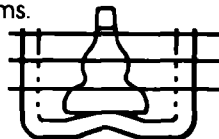

**CAUTION:  
DO NOT  
OVERLOAD WASHER.**

**EX LARGE** (21.7 gals./82.1L)\*  
**MEDIUM** (16.4 gals./62.1L)\*  
**EX SMALL** (11.9 gals./45.0 L)\*

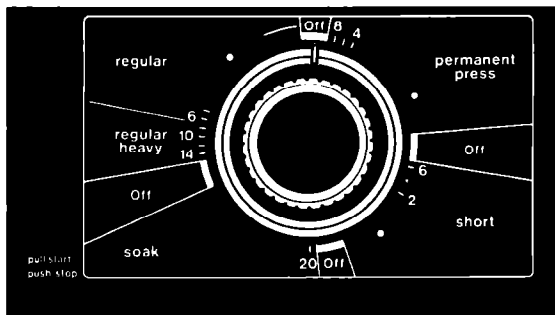

### 3. Select CYCLE and WASH TIME;

#### Start the washer

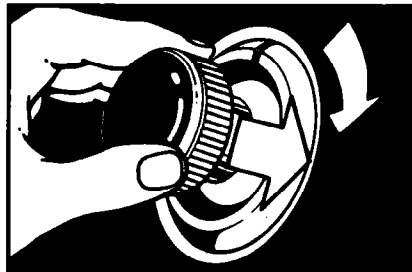

**A.** Push in the Control Knob and turn it to the right. It must be pushed in and turned only clockwise.

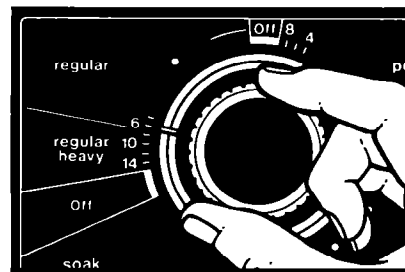

**B.** Stop on a number in the cycle you want. The numbers are minutes of wash time. The drawing shows 6 minutes of agitation in the REGULAR Cycle.

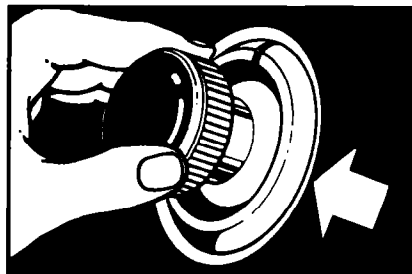

**C.** Start the washer by pulling out the Control Knob. The washer will fill to the level you set with wash water of the selected temperature. After filling, the washer will agitate for the selected number of minutes.

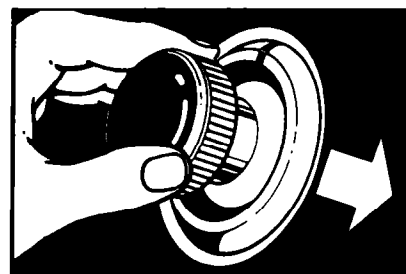

**D.** To stop the washer at any time, push in the Control Knob. To restart the washer, pull out the Control Knob.

## What Happens in Each Cycle\*

Each cycle has been designed for different kinds of fabrics. Numbers on the dial in each cycle are the minutes of WASH agitation time.

When the Cycle Control Knob is set to a number and pulled out, the washer fills before agitation and timing starts. After agitation starts, the knob turns clockwise until it points to OFF and the cycle ends.

### REGULAR HEAVY Cycle

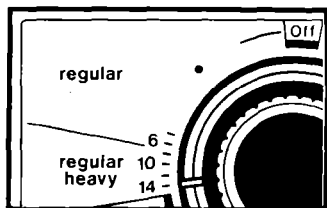

A cycle for sturdily constructed fabrics that are heavily soiled.

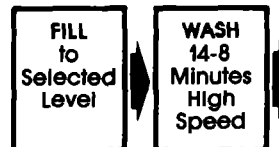

### REGULAR Cycle

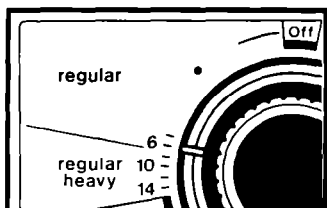

A cycle for regular loads of fabrics that are moderately soiled.

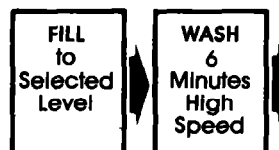

### PERMANENT PRESS Cycle

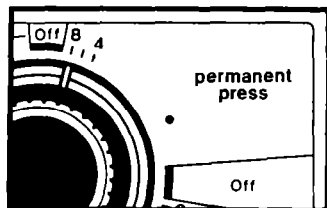

A cycle designed for lightly to moderately soiled permanent press and some synthetic fabrics. The **cool-down** rinse helps keep wrinkles from setting into these fabrics.

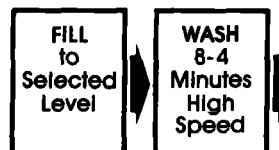

**NOTE:** You may hear the sound of water spraying during the spin parts of some cycles. In some cycles, cold water is sprayed on the spinning load to help with the rinsing.

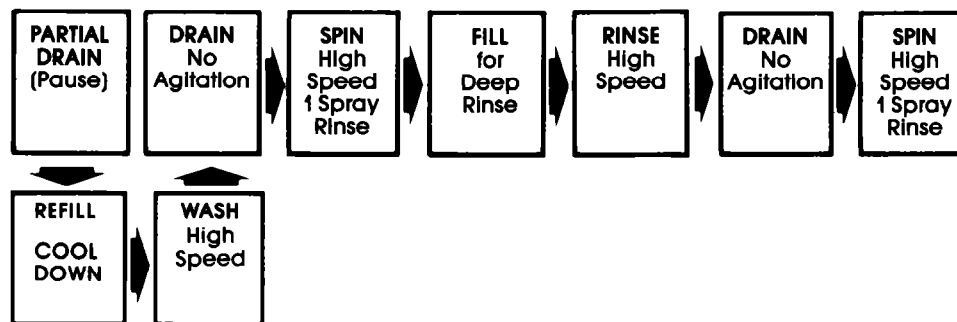
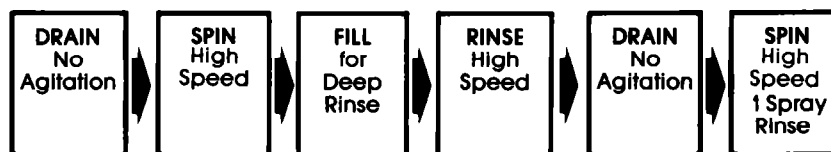
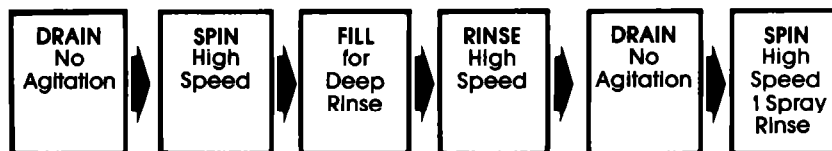

**\* IMPORTANT: THE WASHER WILL PAUSE BRIEFLY THROUGHOUT EACH CYCLE.** These pauses are normal. They allow for the reversing of the motor, normal washer operation, and the cool down portion of the **PERMANENT PRESS** Cycle.

## SHORT Cycle

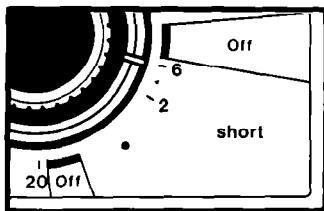

Use for delicate items that need a short wash and spin time. Wash nylon hose or panty hose in a net laundry bag.

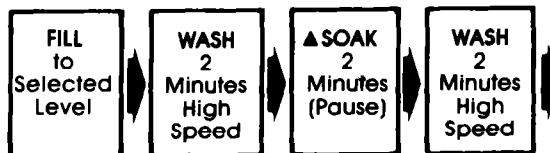

▲ Indicates the machine is pausing for a brief soak period.

## SOAK Cycle

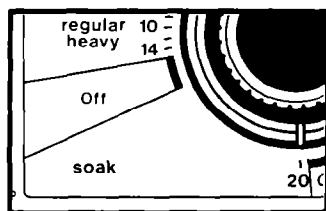

Brief periods of agitation and soak time help remove heavy soils and certain stains that need extra pretreatment. Use recommended amount of detergent or pre-soak additive. **The SOAK Cycle should always be followed by a Wash Cycle.**

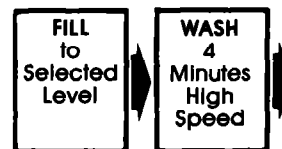



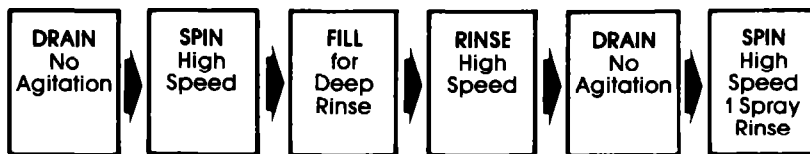

**IMPORTANT: THE WASHER WILL PAUSE BRIEFLY THROUGHOUT EACH CYCLE.** These pauses are normal. They allow for the reversing of the motor, normal washer operations, and the cool down portion of the **PERMANENT PRESS** Cycle.

# Other operating instructions

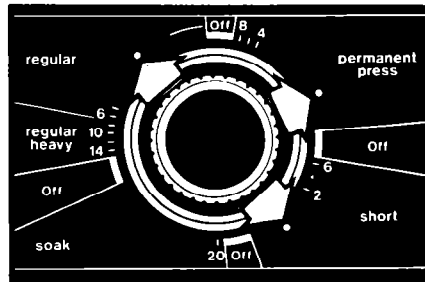

## For a rinse and spin

You may need an extra rinse and spin for heavily soiled loads which need more detergent. (Extra detergent can require an extra rinse.)

1. Push Control Knob in.
2. Turn clockwise to any ● on the dial. **See above drawing.**
3. Pull Control Knob out. The washer will fill to selected level; agitate 2 minutes; drain and spin.

For agitation and spin speeds in each cycle, see pages 6-9.

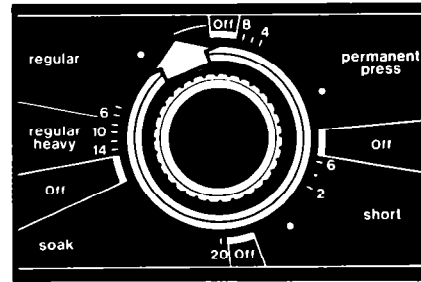

## For a drain and spin

Your washer can be set to drain and spin out water.

1. Push Control Knob in.
2. Turn clockwise to the bar just before the OFF area. **See above drawing.**
3. Pull Control Knob out. The washer will drain and spin.

## For a soak

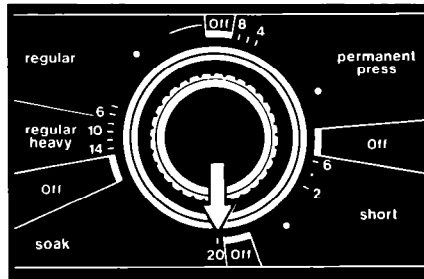

For best results, use **warm** water for soaking or pre-washing stained laundry. **Hot water can set stains.**

1. Use recommended amount of detergent or pre-soak product.
2. Push Control Knob in.
3. Turn clockwise to point to the **number** in the SOAK Cycle.
4. Pull Control Knob out. The washer will start.
5. When the cycle is over, add detergent for the next selected wash cycle. **The SOAK Cycle should always be followed by a Wash Cycle.**

**Important: See additional care information in your "Laundry Guide."**

\*To start soak with agitation, the Control Knob must point to a number in the SOAK Cycle.

## Liquid bleach dispenser

Always measure bleach. Do not guess. Never use more than 1 cup (250 mL) for a full load. Use less with lower water level settings. Follow directions on bottle for safe use. Use a cup with a pouring spout to avoid spilling.

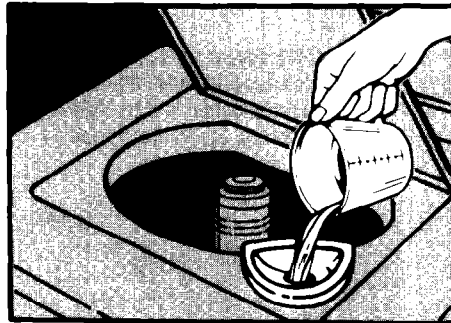
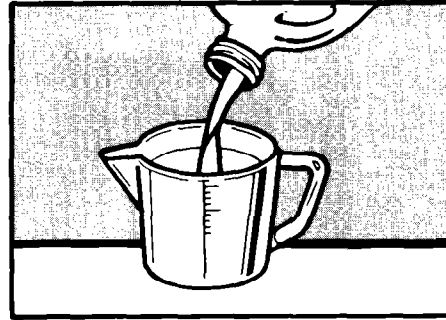

1. Load the washer first.
2. Pour **measured** bleach carefully into dispenser. **DO NOT** let bleach splash, drip or run down into the washer basket. **Undiluted bleach will damage any fabric it touches.**
3. Start the washer. Bleach will be diluted automatically during the wash part of the cycle.

For more information on bleaching, see your "Laundry Guide."

## Cleaning the lint filter

Clean filter after every load for best filtering results. **NOTE: The load type will vary the amount of lint build-up.**

To clean:

1. Lift off the agitator barrel.
2. Wash or wipe the filter clean in the bottom of the agitator barrel. **The filter is not removable.**
3. Replace the agitator barrel and snap into place.

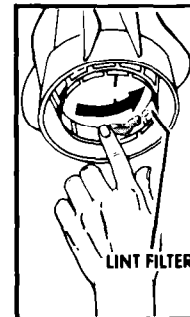
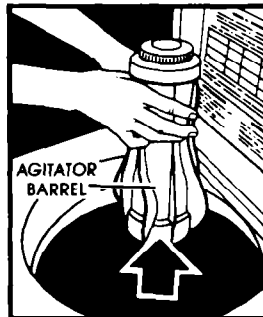

# Caring for your washer

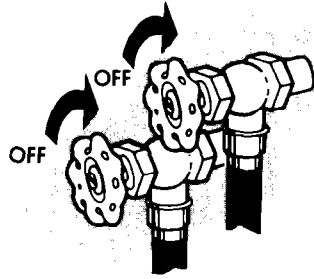

**WHEN NOT WASHING**, keep both water faucets turned off, this takes the pressure off the water inlet valve and hoses.



**AFTER WASHING**, use a soft dry cloth to wipe the outside and inside dry. Leave the lid up until the basket is dry. **Wipe up spills right away.** Spills can dull or damage the finish.

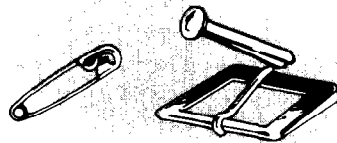

**REMOVE SHARP OBJECTS** such as pins, buckles, etc., from clothes before washing. Close metal zippers.

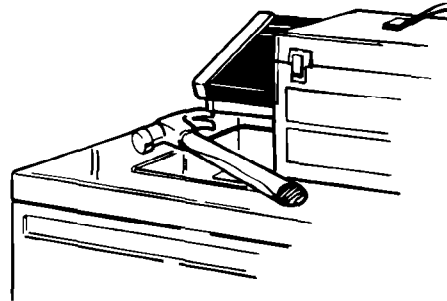

**SHARP OR HEAVY OBJECTS** should never be put on or in the washer. Check pocket for bolts, nuts, tools, etc.

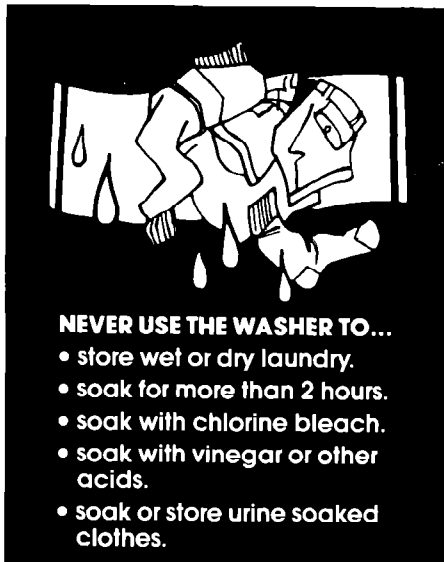

## **NEVER USE THE WASHER TO...**

- store wet or dry laundry.
- soak for more than 2 hours.
- soak with chlorine bleach.
- soak with vinegar or other acids.
- soak or store urine soaked clothes.

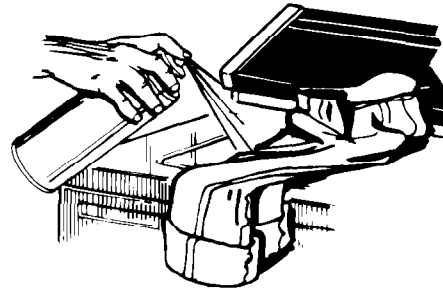

**SOME PRETREATMENT PRODUCTS** can damage washer and dryer dials, consoles and finishes. Do not use these products on or near your washer or dryer.

Service or performance problems caused by the use of any product not manufactured by Whirlpool Corporation are the responsibility of the manufacturer of that product.

## Winterizing

Because some water stays in the washer, freezing can cause a lot of damage. If your washer is **stored or moved** during the cold weather...

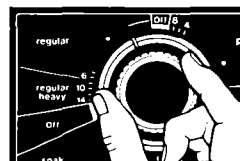
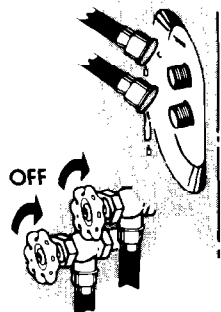
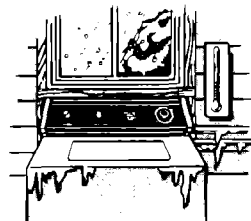

1. Shut off both water faucets. Disconnect and drain water inlet hoses.
2. Put a quart of R.V. or automobile type antifreeze in the basket.
3. Set the washer for a DRAIN and SPIN (see page 10). Let it run for about 30 seconds to mix the antifreeze and water.

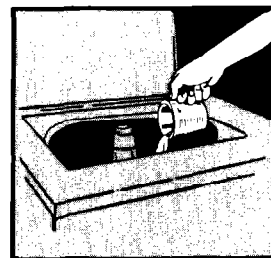
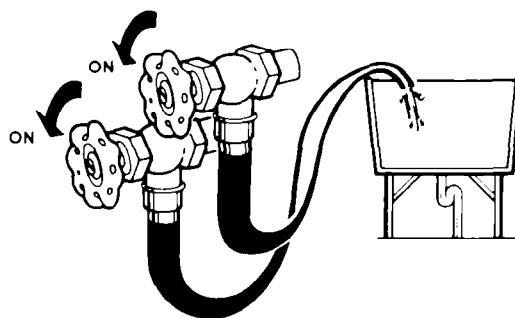

### To use the washer again...

1. Flush water pipes and hoses.
  2. Connect hoses to the washer
  3. Turn on the water faucets.
4. Run the washer through a complete cycle with one cup of detergent to clean out the antifreeze.

# If you need service or assistance, we suggest you follow these five steps:



## 1. Before calling for assistance...

Performance problems often result from little things you can find and fix yourself without tools of any kind.

### If your washer does not fill:

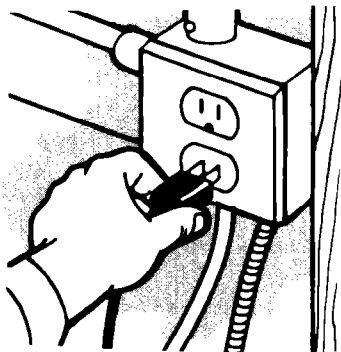

- Is the power supply cord plugged into a live circuit with the proper voltage?

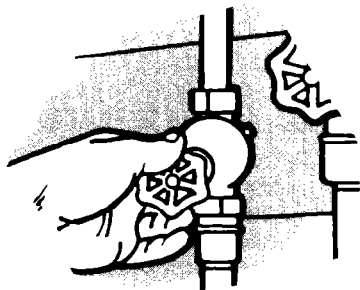

- Are both water faucets open?

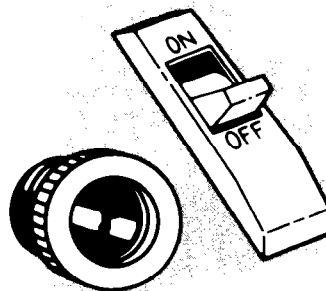

- Have you checked your home's main fuses or circuit breaker box?
- Are the water supply hoses kinked?
- Is the Cycle Control Knob set and pulled out?

### If your washer does not spin:

- Is the lid closed?
- Is the power supply cord plugged into a live circuit with the proper voltage?
- Have you checked your home's main fuses or circuit breaker box?

### If your washer stops during a cycle:

- Remember, the washer pauses briefly at different times in each cycle. These pauses are normal.

### If your washer fills and drains without running:

- Make sure that the Cycle Control Knob is pointing to a number in the cycle.

### Make sure the drain hose is higher than the water level in the washer.

#### If it isn't:

- The washer may seem to be draining during wash and rinse cycles.
- Water can siphon out. (See "Installation Instructions.")

## 2. If you need assistance\*...

Call Whirlpool COOL-LINE® service assistance telephone number. Dial free from anywhere in the U.S.:  
**1-800-253-1301**

and talk with one of our trained Consultants. The Consultant can instruct you in how to obtain satisfactory operation from your appliance or, if service is necessary, recommend a qualified service company in your area.

## 3. If you need service\*...



Whirlpool has a nationwide network of franchised TECH-CARE® Service Companies, TECH-CARE service technicians

are trained to fulfill the product warranty and provide after-warranty service, anywhere in the United States. To locate TECH-CARE service in your area, call our COOL-LINE service assistance telephone number (see Step 2) or look in your telephone directory Yellow Pages under:

APPLIANCES - HOUSEHOLD -  
 MAJOR - SERVICE & REPAIR

ELECTRICAL APPLIANCES -  
 MAJOR - REPAIRING & PARTS

OR

WHIRLPOOL APPLIANCES  
 FRANCHISED TECH-CARE SERVICE

WHIRLPOOL APPLIANCES  
 FRANCHISED TECH-CARE SERVICE

SERVICE COMPANIES

SERVICE COMPANIES

XYZ SERVICE CO  
 123 MAPLE

XYZ SERVICE CO  
 123 MAPLE

999 9999

999 9999

OR

WASHING MACHINES, DRYERS  
 & IRONERS - SERVICING

WHIRLPOOL APPLIANCES  
 FRANCHISED TECH-CARE SERVICE

SERVICE COMPANIES

XYZ SERVICE CO  
 123 MAPLE

999 9999

## 4. If you have a problem\*...

Call our COOL-LINE service assistance telephone number (see Step 2) and talk with one of our Consultants, or if you prefer, write to:

Mr. Robert Stanley  
 Division Vice President  
 Whirlpool Corporation  
 2000 M-63  
 Benton Harbor, MI 49022

## 5. If you need FSP® replacement parts\*...

FSP is a registered trademark of Whirlpool Corporation for quality parts. Look for this symbol of quality whenever you need a replacement part for your Whirlpool appliance. FSP replacement parts will fit right and work right, because they are made to the same exacting specifications used to build every new Whirlpool appliance.

\*If you must call or write, please provide: model number, serial number, date of purchase, and a complete description of the problem. This information is needed in order to better respond to your request for assistance.

# WHIRLPOOL® AUTOMATIC WASHER WARRANTY

LENGTH OF WARRANTY	WHIRLPOOL WILL PAY FOR
<b>FULL ONE-YEAR WARRANTY</b> From Date of Purchase	FSP® replacement parts and repair labor to correct defects in materials or workmanship. Service must be provided by a franchised TECH-CARE® service company.
<b>LIMITED FIVE-YEAR WARRANTY</b> From Date of Purchase	FSP replacement parts for any part of gearcase assembly if defective in materials or workmanship. The gearcase assembly is shown below.
<b>LIMITED TEN-YEAR WARRANTY</b> From Date of Purchase	FSP replacement of outer tub should it crack, or fail to contain water, due to defective materials or workmanship.
<b>WHIRLPOOL WILL NOT PAY FOR</b>	
<p><b>A.</b> Service calls to:</p> <ol style="list-style-type: none"> <li>1. Correct the installation of the washer.</li> <li>2. Instruct you how to use the washer.</li> <li>3. Replace house fuses or correct house wiring or plumbing.</li> </ol> <p><b>B.</b> Repairs when washer is used in other than normal, single-family household use.</p> <p><b>C.</b> Pick up and delivery. This product is designed to be repaired in the home.</p> <p><b>D.</b> Damage to washer caused by accident, misuse, fire, flood, acts of God or use of products not approved by Whirlpool.</p> <p><b>E.</b> Any labor costs during the limited warranties.</p>	

WHIRLPOOL CORPORATION SHALL NOT BE LIABLE FOR INCIDENTAL OR CONSEQUENTIAL DAMAGES. Some states do not allow the exclusion or limitation of incidental or consequential damages so this limitation or exclusion may not apply to you. This warranty gives you specific legal rights, and you may also have other rights which vary from state to state.

Outside the United States, a different warranty may apply. For details, please contact your franchised Whirlpool distributor or military exchange.

**GEARCASE ASSEMBLY  
COVERED BY YOUR  
WARRANTY**

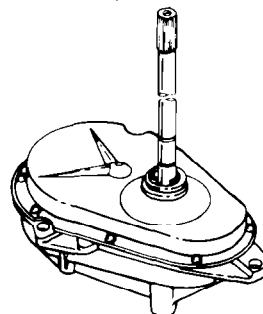

Part No. 3349137  
©1987 Whirlpool Corporation

Printed in U.S.A.

Download from [Www.Somanuals.com](http://Www.Somanuals.com). All Manuals Search And Download.



## Free Manuals Download Website

<http://myh66.com>

<http://usermanuals.us>

<http://www.somanuals.com>

<http://www.4manuals.cc>

<http://www.manual-lib.com>

<http://www.404manual.com>

<http://www.luxmanual.com>

<http://aubethermostatmanual.com>

Golf course search by state

<http://golfingnear.com>

Email search by domain

<http://emailbydomain.com>

Auto manuals search

<http://auto.somanuals.com>

TV manuals search

<http://tv.somanuals.com>