

# use & care guide

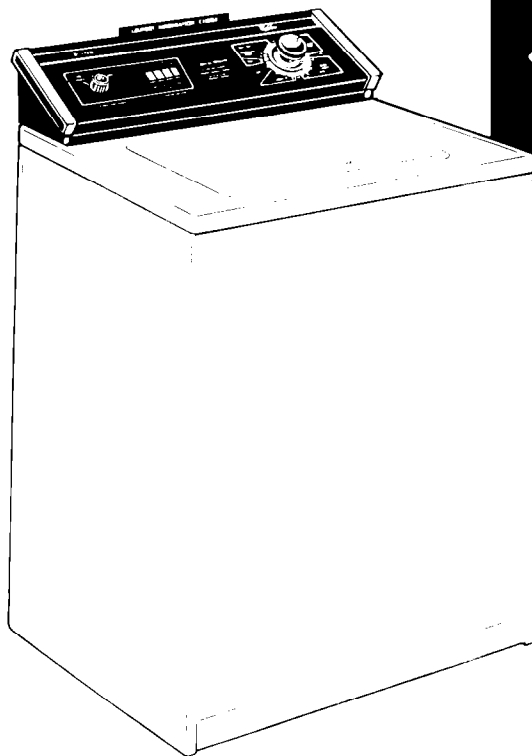

The Whirlpool logo consists of a stylized swirl icon above the word "Whirlpool" in a serif font, all contained within a black rectangular background.

## **AUTOMATIC WASHER**

**Design 2000  
Large Capacity  
Model  
LA7700XP**

rowave Ovens, Trash Compactors, Room Air Conditioners, Dehumidifiers, Automatic Washers, Clothes Dryers, Freezers, Refrigerator-Freezer

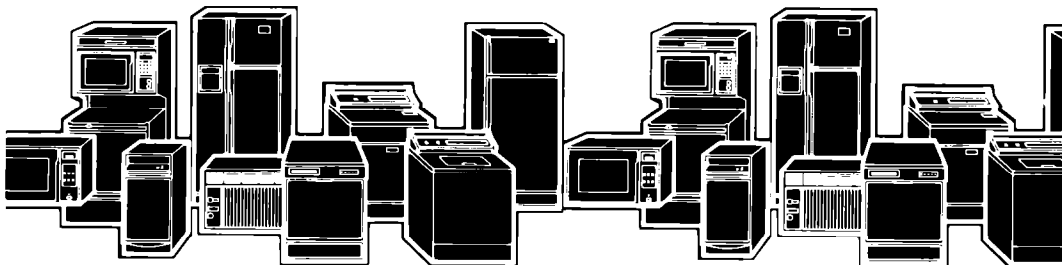

Download from [www.Somanuals.com](http://www.Somanuals.com). All Manuals Search And Download.

# Parts and features

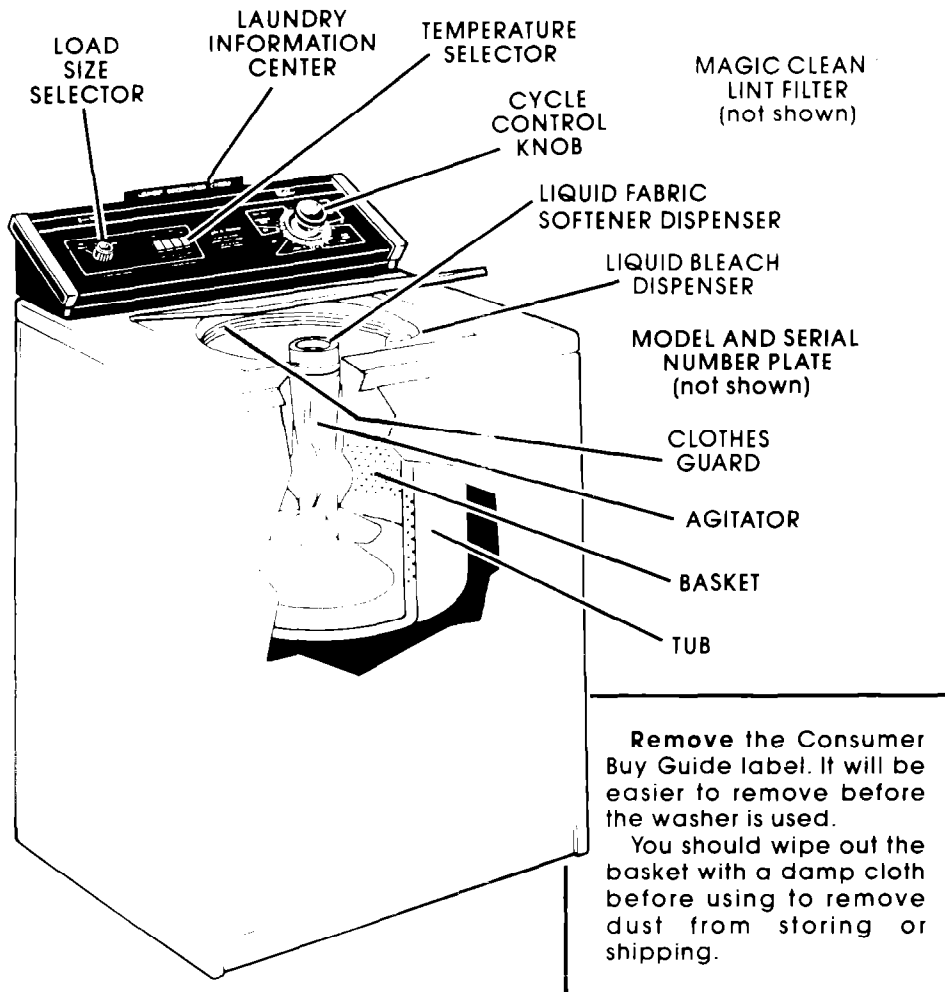

## Copy your Model and Serial Numbers here

When you need service or call with a question, have this information ready:

1. **Complete** Model and Serial Numbers (from plate under the lid near the hinge).
2. Purchase date from sales slip

Copy this information in these spaces. Keep this book in the Laundry Information Center with your "Laundry Guide," sales slip and warranty.

Model Number \_\_\_\_\_

Serial Number \_\_\_\_\_

Purchase Date \_\_\_\_\_

Service Company  
Phone Number \_\_\_\_\_

There is no warranty registration to return. Proof-of-purchase is all that is required for in-warranty service.

# Your responsibilities

Read this "Use and Care Guide" and your "Laundry Guide" carefully for important use and safety information.

You are personally responsible for making sure that your washer...

- is installed by a qualified installer.
- is properly installed and leveled on a floor that can support the weight.
- is connected to the right kind of outlet, electric supply, water supply and drain.
- is properly grounded.
- is used only for jobs normally expected of home automatic washers.
- is properly maintained.
- is protected from the weather and kept where the temperature will not fall below freezing.
- is not run by children or anyone unable to operate it properly.

• See the "Installation Instructions" for complete information.

## Contents

	Page
<b>PARTS AND FEATURES</b>	2
<b>YOUR RESPONSIBILITIES</b>	3
<b>SAFETY FIRST</b>	3
<b>STARTING YOUR WASHER</b>	4
<b>WHAT HAPPENS IN EACH CYCLE</b>	6
<b>OTHER OPERATING INSTRUCTIONS</b>	10
For a Rinse and Spin	10
For a Drain and Spin	10
For a Soak or Pre-Wash	10
Liquid Bleach Dispenser	11
Fabric Softener Dispenser	11
MAGIC CLEAN® Lint Filter	11
<b>CARING FOR YOUR WASHER</b>	12
Winterizing	13
<b>IF YOU NEED SERVICE OR ASSISTANCE</b>	14
1. Before Calling for Assistance	14
2. If You Need Assistance	15
3. If You Need Service	15
4. If You Have a Problem	15

## Safety first

**ALWAYS** unplug the power supply cord before attempting to service the washer.

**NEVER** put flammable fluids (dry-cleaning solvents, gasoline, kerosene) into your washer. **NEVER** use them near your washer.

**ALWAYS** hand launder or air dry fabrics treated with flammable fluids before putting them into your washer.

**NEVER** put your hands into the washer until all motion stops. If the lid is opened while the basket is spinning, the basket will automatically stop in a few seconds.

**DO NOT** allow children to operate or play with the washer.

**ALWAYS** store detergent, laundry aids and other materials in a cool, dry place where children can't reach them – in a locked cabinet, if possible.

**ALWAYS** read and follow instructions on packages of detergent and laundry aids – especially warnings and precautions.

**POISON GAS** can be formed if chlorine bleach is used in the same wash as ammonia or acids such as vinegar or rust remover.

**DO NOT** machine wash glass fiber materials. Small particles can stick to fabrics washed in following loads and cause skin irritation.

**SPECIAL CAUTION:** If hot water has not been used recently (usually two weeks or longer), flammable hydrogen gases may build up in the water heater and hot water pipes. To prevent injury or damage, turn on all hot water faucets and allow water to run for several minutes. This will allow gases to escape. Do not smoke or use any open flame near the faucet while it is open.

– SAVE THESE INSTRUCTIONS –

# Starting your washer

Before starting your washer:



- 1 Measure and add detergent
- 2 Place sorted load in washer
- 3 Start washer

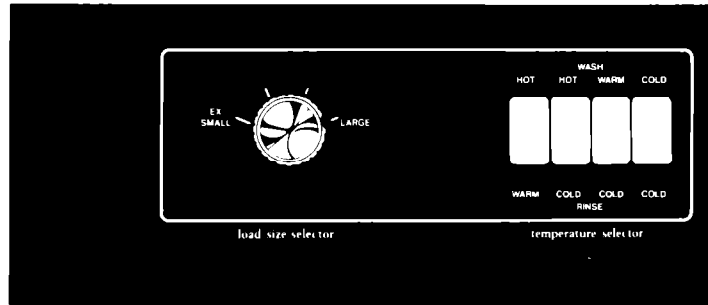

## 1. Select a LOAD SIZE

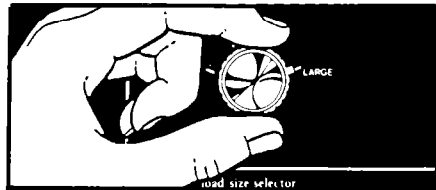

- Turn the knob to point at a setting that describes the size of load you want to wash.
- Set the knob anywhere on or between EX SMALL (a few items) and LARGE (a full load).



**DO NOT LOAD ABOVE CLOTHES GUARD**

**NOTE: Use the LARGE water level for best permanent press results.**

## 2. Select WATER TEMPERATURES

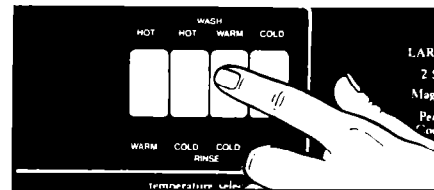

- Select wash and rinse water temperatures by pushing a button.
- This drawing shows a warm wash (top temperature) and cold rinse (bottom temperature) selection.

Recommended wash temperatures can be found in your "Laundry Guide."

**IMPORTANT: Use warm water with the PER'T PRESS or KNITS/ GENTLE cycles. For heavily soiled permanent press or knit clothes, pre-wash or pre-soak before washing in warm water.**

## LOAD SIZES AND WATER LEVELS

For best cleaning results, the load must be able to move freely in the water. Too big a load or too little water can cause wear or tearing of load items.

\*Approximate fill with load.

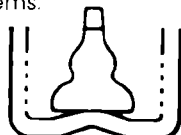

**DO NOT OVERLOAD WASHER.**

**LARGE** (17.3 gals./65.5 L)\*  
 - (14.7 gals./55.7 L)\*  
 - (12.1 gals./45.8 L)\*  
**EX SMALL** (9.5 gals./36.0 L)\*

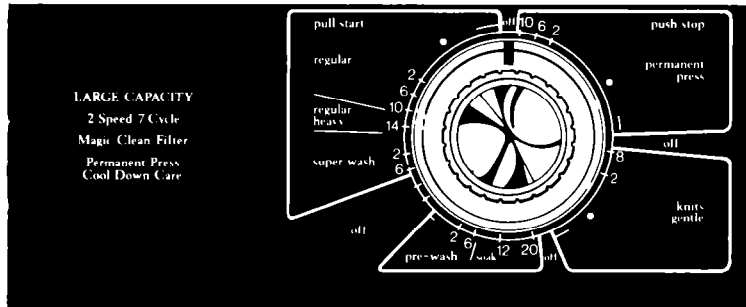

### Select CYCLE and WASH TIME; 3. Start the washer

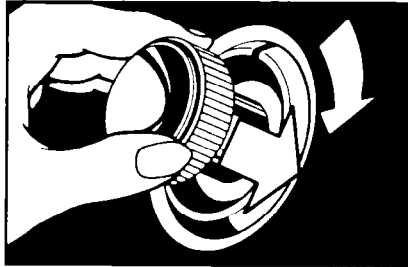

**A.** Push in the Control Knob and turn it to the right. It must be pushed in and turned only clockwise

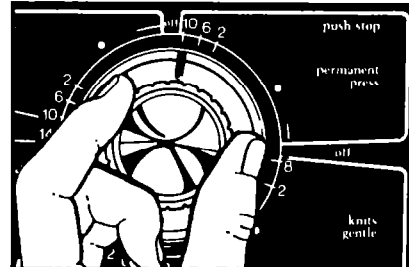

**B.** Stop on a number in the cycle you want. The numbers are minutes of wash time. The drawing shows 10 minutes of agitation in the REGULAR Cycle.

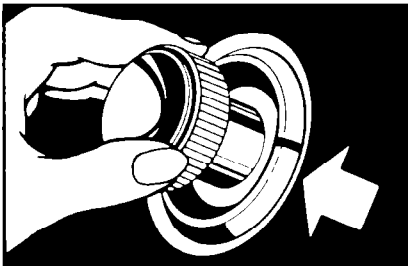

**C.** Start the washer by pulling out the Control Knob. The washer will fill to the level you set with wash water of the selected temperature. After filling, the washer will agitate for the selected number of minutes

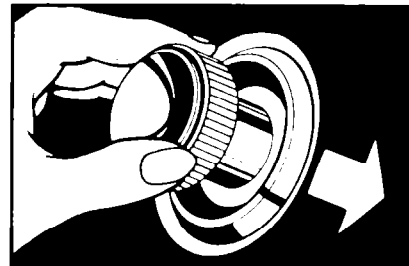

**D.** To stop the washer at any time push in the Control Knob. To restart the washer, pull out the Control Knob.

# What happens in each cycle \*

Each cycle has different agitation and spin speeds designed for different kinds of fabrics. Numbers on the dial in each cycle are the minutes of WASH agitation time.

When the Cycle Control Knob is set to a number and pulled out, the washer fills before agitation and timing starts. After agitation starts, the knob turns clockwise until it points to OFF and the cycle ends.

## REGULAR HEAVY Cycle

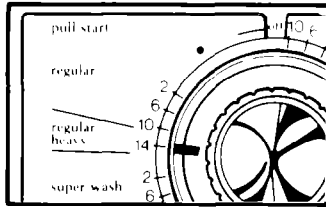

A cycle for sturdily constructed fabrics that are heavily soiled

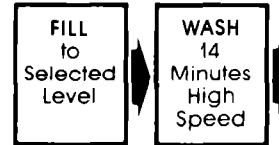

## REGULAR Cycle

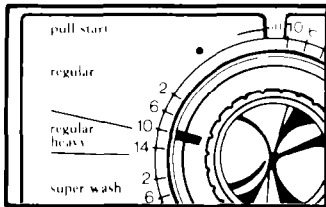

A cycle for regular loads of fabrics that are moderately soiled.

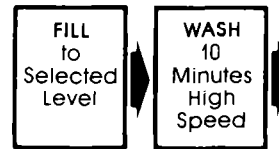

## PERMANENT PRESS Cycle

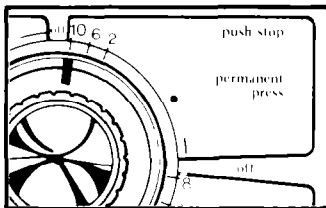

A special cycle with the necessary **cool down** rinse which helps keep wrinkles from setting into Permanent Press and some synthetic fabrics.

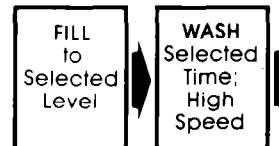

**\* IMPORTANT: THE WASHER WILL PAUSE BRIEFLY AT DIFFERENT TIMES IN EVERY CYCLE. These pauses are normal. They allow for the reversing of the motor and normal washer operations.**

**NOTE:** You may hear the sound of water spraying during the spin parts of some cycles. In some cycles, cold water is sprayed on the spinning load to help with the rinsing.

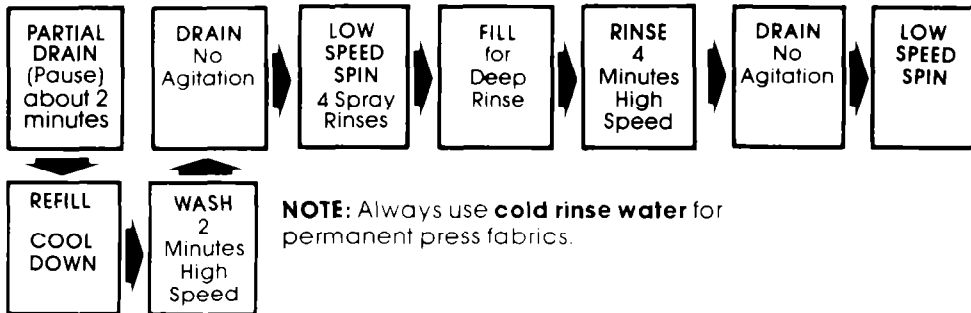
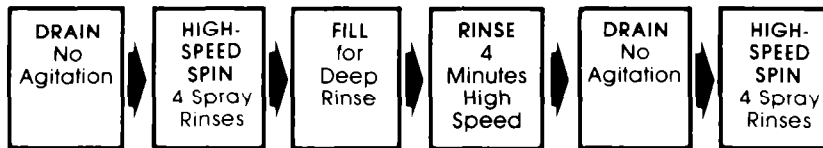
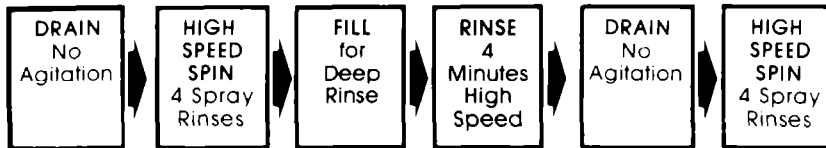

## KNITS/GENTLE Cycle

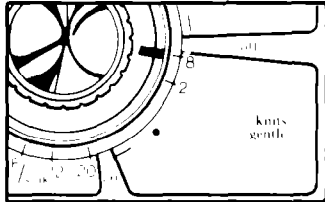

A cycle that gently washes and spins delicate items and washable knits.

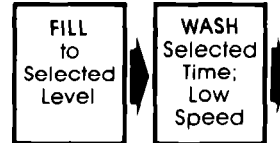

## SOAK AND PRE-WASH Cycles

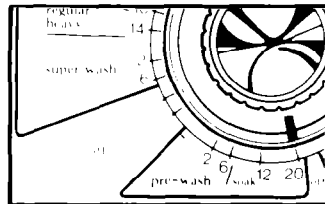

Brief periods of agitation and soak time help remove heavy soils and certain stains that need extra pretreatment. Use recommended amount of detergent or pre-soak additive. **The SOAK Cycle should always be followed by a Wash Cycle.**

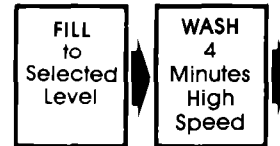

## SUPER WASH Cycle

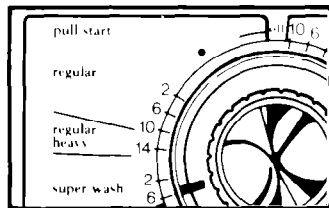

Use for washing heavily soiled loads that require maximum soil removal. **Double** the amount of detergent recommended when using the SUPER WASH Cycle.

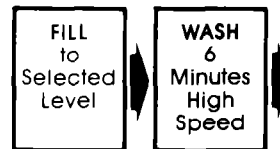

**\* IMPORTANT: THE WASHER WILL PAUSE BRIEFLY AT DIFFERENT TIMES IN EVERY CYCLE. These pauses are normal. They allow for the reversing of the motor and normal washer operations.**



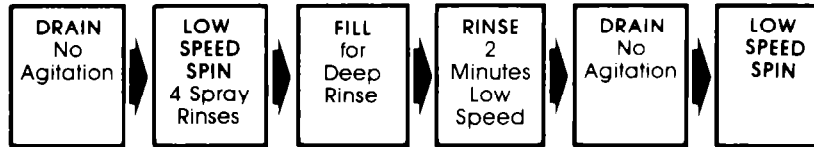

← Pre-wash setting begins here, (see page 10).

Special care is needed when soaking or pre-washing laundry.  
See your "Laundry Guide" for proper use of this cycle.

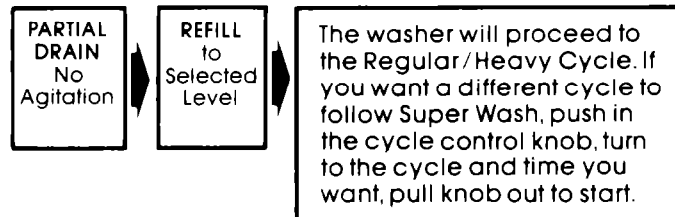

# Other operating instructions

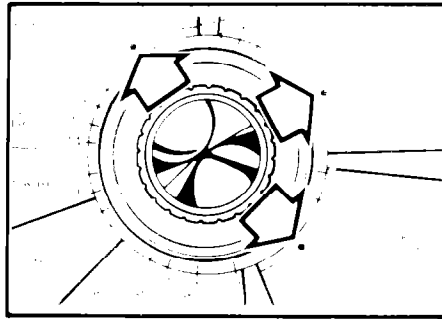

## For a rinse and spin

You may need an extra rinse and spin for heavily soiled loads which need more detergent. (Extra detergent can require an extra rinse.)

- Push Control Knob in.
- Turn clockwise to any ● on the dial. **See above drawing.**
- Pull Control Knob out.
- The washer will fill to selected level; agitate 2 minutes; drain and spin.

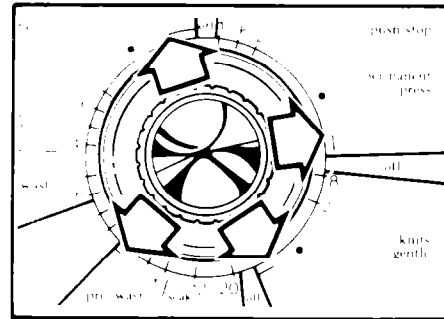

## For a drain and spin

Your washer can be set to drain and spin out water.

- Push Control Knob in.
- Turn clockwise to the bar just before OFF in any cycle. **See above drawing.**
- Pull Control Knob out.
- The washer will drain and spin.

For agitation and spin speeds in each cycle, see pages 6-9.

## For a soak or pre-wash

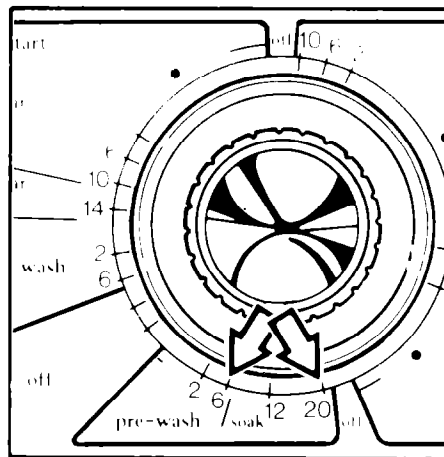

For best results, use **warm** water for soaking or pre-washing stained laundry. **Hot water can set stains.**

- Use recommended amount of detergent or pre-soak product.
- Push Control Knob in.
- Turn clockwise to point at a **number** in the SOAK Cycle...use the 6-minute mark for a pre-wash.\*
- Pull Control Knob out to start washer.
- When the cycle is over, add detergent for the next selected wash cycle. **The SOAK Cycle should always be followed by a Wash Cycle.**

**Important: See additional care information on page 7 of your "Laundry Guide."**

\*To start soak or pre-wash with agitation, the Cycle Control Knob must point to a number in the SOAK Cycle.

## Liquid bleach dispenser

**Always measure bleach.** Do not guess. **Never use more than 1 cup (250 mL) for a full load.** Use less with lower water level settings. Follow directions on bottle for safe use. Use a cup with a pouring spout to avoid spilling.

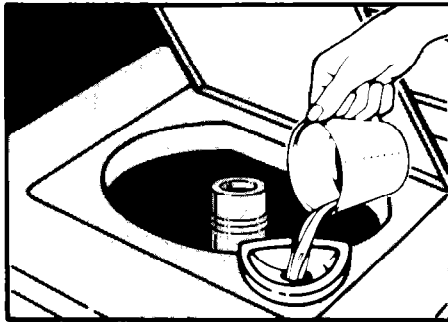
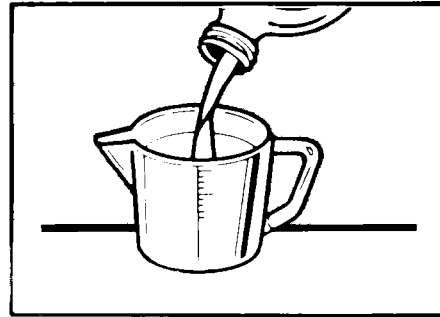

For more information on bleaching, see "Laundry Guide" page 11.

1. Load the washer first.
2. Pour **measured** bleach carefully into dispenser. **DO NOT** let bleach splash, drip or run down into the washer basket. **Undiluted bleach will damage any fabric it touches.**
3. Start the washer. Bleach will be diluted automatically during the wash part of the cycle.

## Liquid fabric softener dispenser

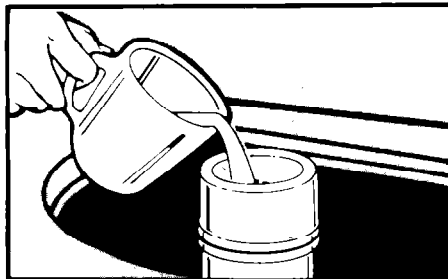

1. Add detergent and load to the basket.
2. Add liquid fabric softener to the dispenser using the amount recommended on the bottle.
3. Avoid dripping or spilling any fabric softener on the load.

4. **Dilute** fabric softener with hot water. Add enough hot water to fill the dispenser up to the opening.
5. Start the washer. Diluted liquid fabric softener will be added to the load during the deep rinse portion of the cycle.

**NOTE: Do not stop the washer during this time.** If you do, the softener will mix with the remaining soapy wash water. This will cause stains. **Do not put detergent in the liquid fabric softener dispenser.**

6. If dispenser needs cleaning, flush with hot water. **NOTE: Do not wash clothes with dispenser removed.**

## MAGIC CLEAN® lint filter

The lint filter in your washer cleans itself. Collected lint is drained away with the wash and rinse water.

If your washer drains into a tub, remove any lint collected in the drain or strainer

# Caring for your washer

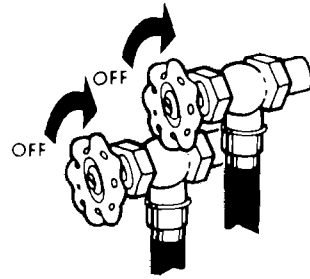

**WHEN NOT WASHING**, keep both water faucets turned off. This takes the pressure off the water inlet valve and hoses.

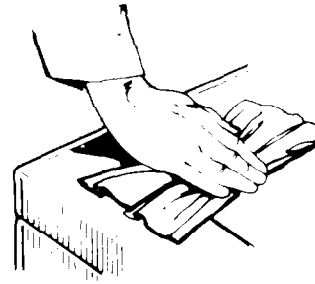

**AFTER WASHING**, use a soft dry cloth to wipe the outside and inside dry. Leave the lid up until the basket is dry. **Wipe up spills right away.** Spills can dull or damage the finish.

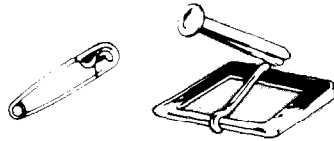

**REMOVE SHARP OBJECTS** such as pins, buckles, etc., from clothes before washing. Close metal zippers.

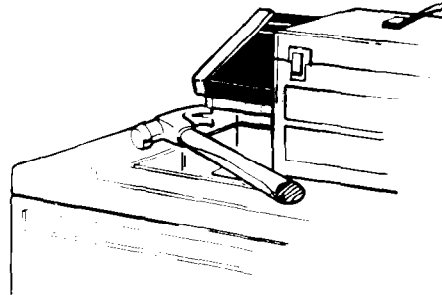

**SHARP OR HEAVY OBJECTS** should never be put on or in the washer. Check pockets for bolts, nuts, tools, etc.



## **NEVER USE THE WASHER TO...**

- store wet or dry laundry.
- soak for more than 2 hours.
- soak with chlorine bleach.
- soak with vinegar or other acids.
- soak or store urine soaked clothes.

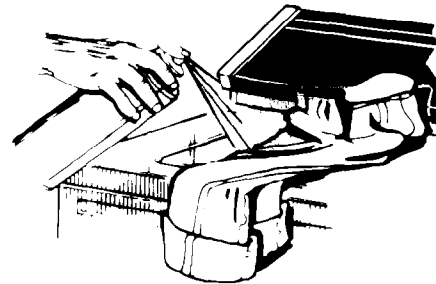

**SOME PRETREATMENT PRODUCTS** can damage washer and dryer dials, consoles and finishes. Do not use these products on or near your washer or dryer.

Service or performance problems caused by the use of any product not manufactured by Whirlpool Corporation are the responsibility of the manufacturer of that product.

## Winterizing

Because some water stays in the washer, freezing can cause a lot of damage. If your washer is **stored or moved** during the cold weather

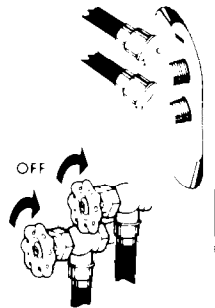
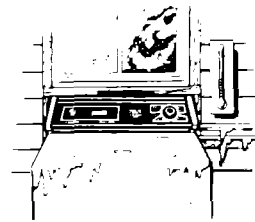

1. Shut off both water faucets. Disconnect and drain water inlet hoses



2. Put a quart of automobile-type antifreeze in the basket

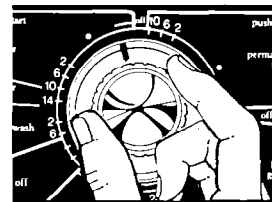

3. Set the washer for a DRAIN and SPIN (see page 10). Let it run for about 30 seconds to mix the antifreeze and water.

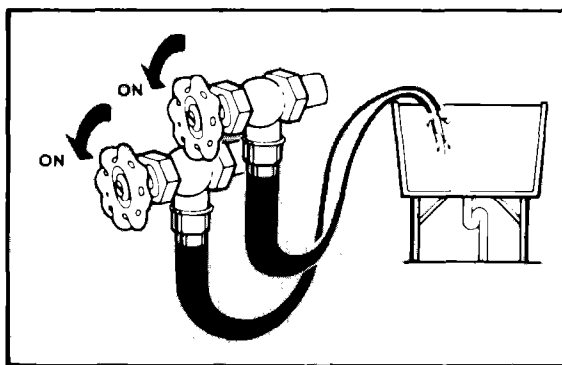

### To use the washer again...

1. Flush water pipes and hoses.
2. Connect hoses to the washer.
3. Turn on the water faucets

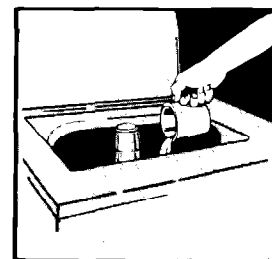

4. Run the washer through a complete cycle with one cup of detergent to clean out the antifreeze.

## If you need service or assistance, we suggest you follow these four steps:

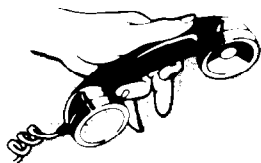

### 1. Before calling for assistance...

Performance problems often result from little things you can find and fix yourself without tools of any kind.

#### IF YOUR WASHER DOES NOT FILL:

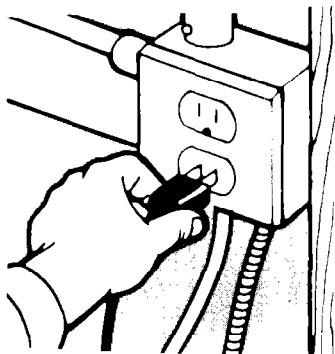

- Is the power supply cord plugged in?

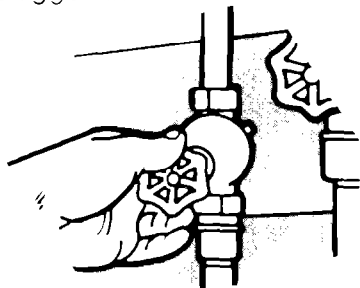

- Are both water faucets open?

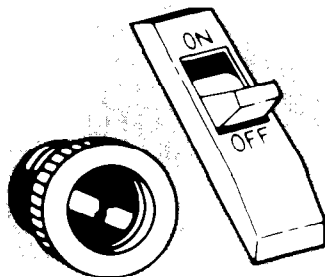

- Are fuses blown or circuit-breaker tripped?
- Are the water supply hoses kinked?
- Is the Cycle Control Knob set and pulled out?

#### IF YOUR WASHER DOES NOT SPIN:

- Is the lid closed?
- Is the power supply cord plugged in?
- Is a fuse blown or circuit-breaker tripped?

#### IF YOUR WASHER STOPS DURING A CYCLE:

- Remember, the washer pauses briefly at different times in each cycle. These pauses are normal.

#### IF WASHER FILLS AND DRAINS WITHOUT RUNNING:

- Make sure that the Cycle Control Knob is pointing to a number in the cycle.

#### MAKE SURE THE DRAIN HOSE IS HIGHER THAN THE WATER LEVEL IN THE WASHER. IF IT ISN'T...

- The washer may seem to be draining during wash and rinse cycles.
- Water can siphon out. (See "Installation Instructions.")

**2. If you need assistance...**

Call Whirlpool **COOL-LINE**™ service assistance telephone number. Dial free from:

**Continental U.S. . . . . (800) 253-1301**  
**Michigan . . . . . (800) 632-2243**  
**Alaska & Hawaii (800) 253-1121**

and talk with one of our trained Consultants. The Consultant can instruct you in how to obtain satisfactory operation from your appliance or, if service is necessary, recommend a qualified service company in your area.

**3. If you need service...**



Whirlpool has a nationwide network of franchised **TECH-CARE** Service Companies. **TECH-CARE** service technicians are trained to fulfill the product warranty and provide after-warranty service, anywhere in the United States. To locate **TECH-CARE** service in your area, call our **COOL-LINE** service assistance telephone number (see Step 2) or look in your telephone directory Yellow Pages under:

APPLIANCES, HOUSEHOLD MAJOR SERVICE & REPAIR	OR	ELECTRICAL APPLIANCES, MAJOR REPAIRING & PARTS
WHIRLPOOL APPLIANCES, FRANCHISED TECH-CARE SERVICE		WHIRLPOOL APPLIANCES, FRANCHISED TECH-CARE SERVICE
SERVICE COMPANIES KTC SERVICE CO. 721 Maple 298-3999		SERVICE COMPANIES KTC SERVICE CO. 721 Maple 999-9999
OR		
WASHING MACHINES, DRYERS & IRONERS, SERVICING		
WHIRLPOOL APPLIANCES, FRANCHISED TECH-CARE SERVICE		
SERVICE COMPANIES KTC SERVICE CO. 721 Maple 441-1111		

**4. If you have a problem...**

Call our **COOL-LINE** service assistance telephone number (see Step 2) and talk with one of our Consultants, or if you prefer, write to:

Mr. Robert F. Gunts, Vice President  
 Whirlpool Corporation  
 Administrative Center  
 2000 US-33, North  
 Benton Harbor, MI 49022

If you must call or write, please provide: model number, serial number, date of purchase, and a complete description of the problem. This information is needed in order to better respond to your request for assistance.



FSP is a registered trademark of Whirlpool Corporation for quality parts. Look for this symbol of quality whenever you need a replacement part for your Whirlpool appliance. FSP replacement parts

will fit right and work right, because they are made to the same exacting specifications used to build every new Whirlpool appliance.



Making your world a little easier

Part No. 386898  
© 1984 Whirlpool Corporation

Printed in U.S.A.

Automatic Washers, Clothes Dryers, Freezers, Refrigerator-Freezers, Ice Makers, Dishwashers, Built-In Ovens, and Surface Units, Ranges, Mic

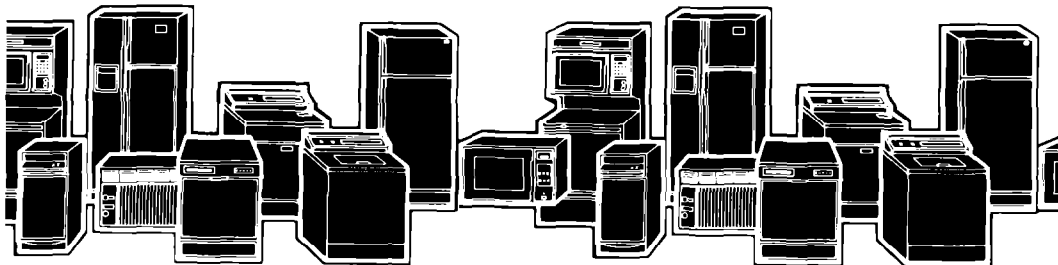



## Free Manuals Download Website

<http://myh66.com>

<http://usermanuals.us>

<http://www.somanuals.com>

<http://www.4manuals.cc>

<http://www.manual-lib.com>

<http://www.404manual.com>

<http://www.luxmanual.com>

<http://aubethermostatmanual.com>

Golf course search by state

<http://golfingnear.com>

Email search by domain

<http://emailbydomain.com>

Auto manuals search

<http://auto.somanuals.com>

TV manuals search

<http://tv.somanuals.com>