

use & care guide

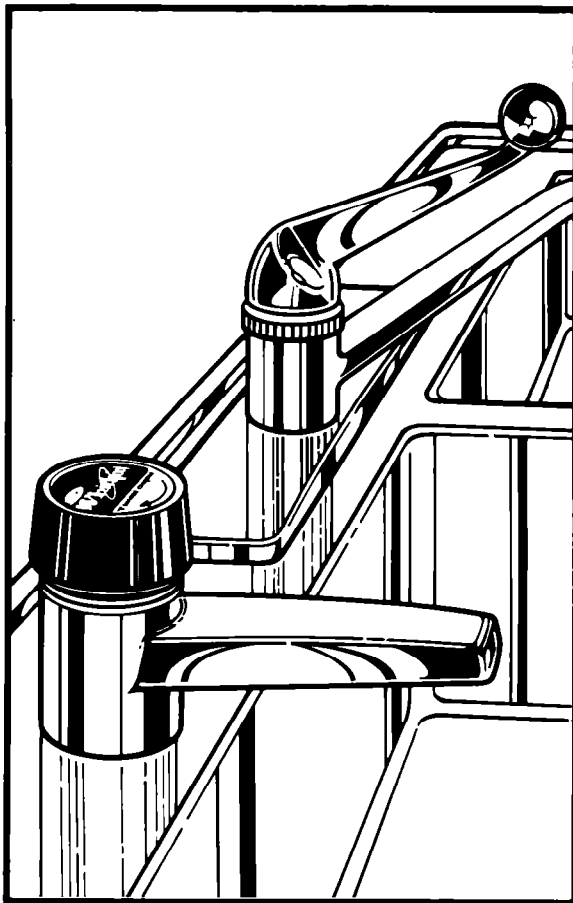

HOT WATER DISPENSER

Model HD1000XS

Freezers. Ice Makers. Dishwashers. Built-In Ovens and Surface Units. Ranges. Microwave Ovens. Trash Compactors. Room Air Conditioners. Dehumidifiers. Automatic Washers. Clothes Dryers. Freezer

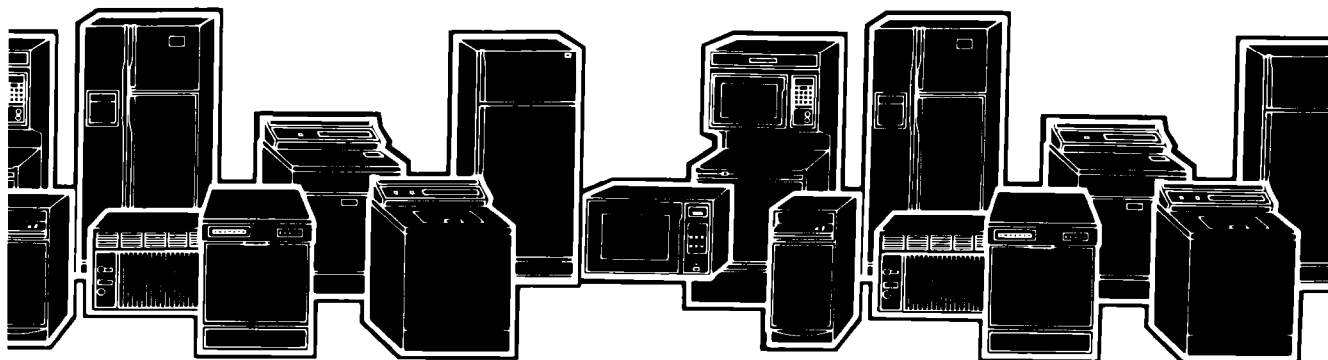

Contents

	Page		Page
BEFORE USING YOUR HOT WATER DISPENSER	2	CARING FOR YOUR HOT WATER DISPENSER	4
PARTS AND FEATURES	3	IF YOU NEED SERVICE OR ASSISTANCE	5
USING YOUR HOT WATER DISPENSER ENERGY SAVING TIP	4	WHIRLPOOL HOT WATER DISPENSER WARRANTY	6

©1987 Whirlpool Corporation

Before using your hot water dispenser

It is your personal responsibility and obligation to be sure your hot water dispenser:

- Is properly installed where it is protected from the elements
- Has been properly connected to electricity and water.*
- Has been properly electrically grounded.*
- Is not used by children or anyone unable to operate it properly.
- Is properly maintained.

*See **Installation Instructions** for complete information.



WARNING – Use care when operating this appliance. Water from the dispenser is hot enough to cause severe burns. Avoid contact with skin.

Parts and features

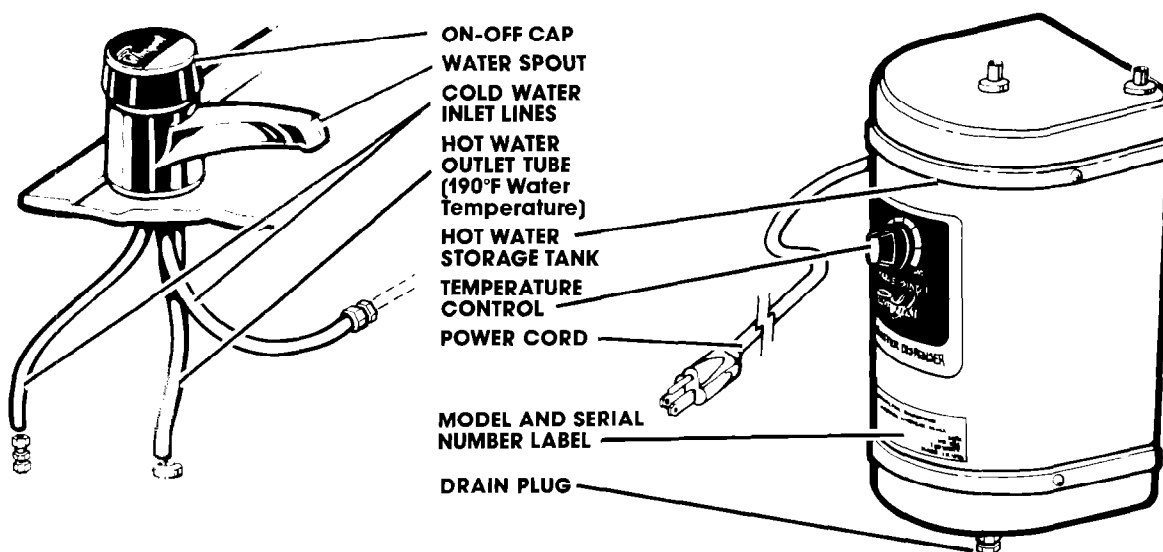

Copy your Model and Serial Numbers here...

When you need service or call with a question, have this information ready:

1. **Complete** Model and Serial Numbers (from the label located as shown)
2. Purchase date from sales slip

Copy this information in these spaces. Keep this book and your sales slip together in a handy place.

Model Number _____

Serial Number _____

Purchase Date _____

Service Company Telephone Number _____

Energy saving tip

If you plan to be away from home more than two days, you may want to turn the temperature control to "OFF" to eliminate energy consumption during your absence. You **will not** save any energy by turning the dispenser off at night and back on the next morning.

Caring for your hot water dispenser

Winterizing

Be sure to safeguard your dispenser when it is exposed to freezing temperatures. Drain the storage tank to prevent the water inside from freezing. Freezing will ultimately damage the storage tank.

To Drain:

1. Unplug the power cord.
2. Turn Temperature Control Knob to "OFF."
3. Run hot water dispenser until water is cold.
4. Place at least a 3-quart capacity container under the drain plug on the storage tank.
5. Unscrew the drain plug with a $\frac{9}{16}$ " wrench and allow all water to drain.
6. Replace and tighten the drain plug. **Do not overtighten.**

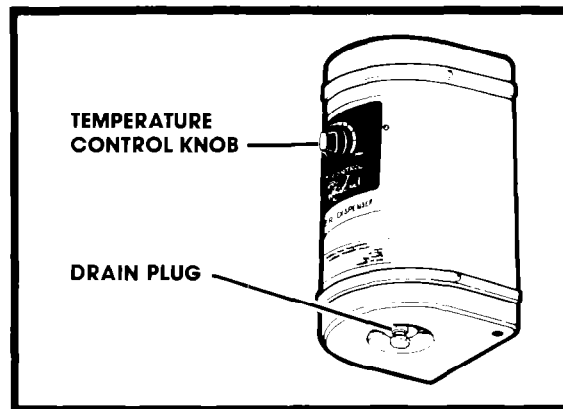

When ready to use the dispenser again, see "Using your hot water dispenser."

CAUTION: DO NOT TURN UNIT ON IF TANK IS EMPTY. Damage to the unit will result and is not covered by the warranty.

Cleaning the Spout Screen

If you have very hard water, it may be necessary to clean the Spout Screen occasionally.

To Remove:

1. Remove the two spout screws.
2. Remove spout base plate.
3. Pull the screen assembly out of the hot water tube.

To Clean:

1. Use a small brush and vinegar to remove deposit.
2. If deposit has hardened, soak in vinegar for an hour or two. Then brush clean.
3. Replace screen assembly in tube and screw plate back onto spout.

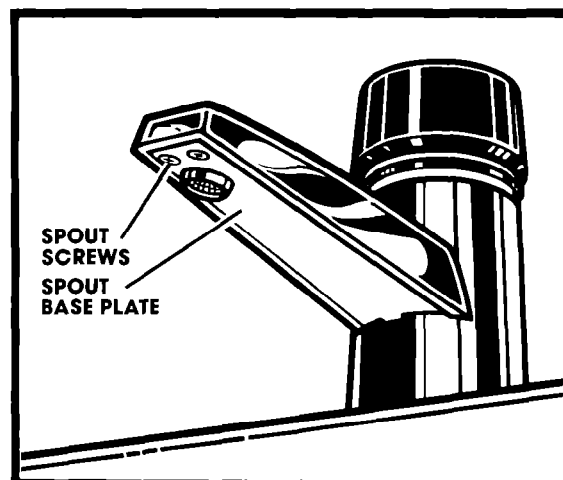

If you need service or assistance, we suggest you follow these five steps:

1. Before calling for assistance...

Performance problems often result from little things you can find and fix yourself.

If water isn't hot:

- Is temperature control set on HIGH? Set on HIGH and test temperature again after 15 minutes.
- Have you checked your home's main fuses or circuit breaker box?

If hot water drips or sputters from spout:

- Is temperature setting too high? Lower the temperature setting and test again after 15 minutes.
- Are there any restrictions in the flexible tubing connecting faucet to storage tank?
- Is the spout screen clogged? See page 4.
- Check for proper installation of copper tubing from faucet to storage tank and faucet to cold water line. If connected backwards, valve may be damaged. See the "Installation Instructions."

If water does not flow:

- Make sure valve on water supply line is open.

Be sure to read this Use & Care Guide for complete instructions.

2. If you need assistance*...

Call Whirlpool COOL-LINE service assistance telephone number. Dial free from anywhere in the U.S.:

1-800-253-1301

and talk with one of our trained Consultants. The Consultants can instruct you in how to obtain satisfactory operation from your appliance or, if service is necessary, recommend a qualified service company in your area.

3. If you need service*...



product warranty and provide after-warranty

Whirlpool has a nationwide network of franchised TECH-CARE® service Companies. TECH-CARE service technicians are trained to fulfill the

service, anywhere in the United States. To locate TECH-CARE service in your area, call our COOL-LINE service assistance telephone number (see Step 2) or look in your telephone directory Yellow Pages under:

APPLIANCES - HOUSEHOLD - MAJOR - SERVICE & REPAIR
WHIRLPOOL APPLIANCES FRANCHISED TECH-CARE SERVICE
SERVICE COMPANIES
XYZ SERVICE CO
123 MAPLE

OR

ELECTRICAL APPLIANCES - MAJOR - REPAIRING & PARTS
WHIRLPOOL APPLIANCES FRANCHISED TECH-CARE SERVICE
SERVICE COMPANIES
XYZ SERVICE CO
123 MAPLE

OR

WASHING MACHINES, DRYERS & IRONERS - SERVICING
WHIRLPOOL APPLIANCES FRANCHISED TECH-CARE SERVICE
SERVICE COMPANIES
XYZ SERVICE CO
123 MAPLE

999-9999

4. If you have a problem*...

Call our COOL-LINE service assistance telephone number (see Step 2) and talk with one of our Consultants, or if you prefer, write to:

Mr. Robert Stanley
Division Vice President
Whirlpool Corporation
2000 M-63
Benton Harbor, MI 49022

5. If you need FSP® replacement parts*...

FSP is a registered trademark of Whirlpool Corporation for quality parts. Look for this symbol of quality whenever you need a replacement part for your Whirlpool appliance. FSP replacement parts will fit right and work right, because they are made to the same exacting specifications used to build every new Whirlpool appliance.

To locate FSP replacement parts in your area, refer to Step 3 above or call the Whirlpool COOL-LINE service assistance number in Step 2.

*If you must call or write, please provide: model number, serial number, date of purchase, and a complete description of the problem. This information is needed in order to better respond to your request for assistance.

Using your hot water dispenser

Before Using the First Time

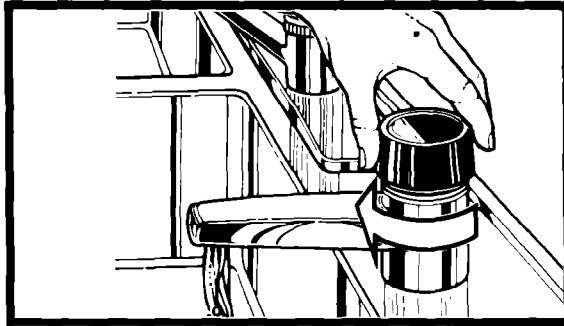

1. Make sure unit is unplugged. Turn the On-Off Cap clockwise and hold open until water flows out the spout. The dispenser will turn off automatically when you release the cap.

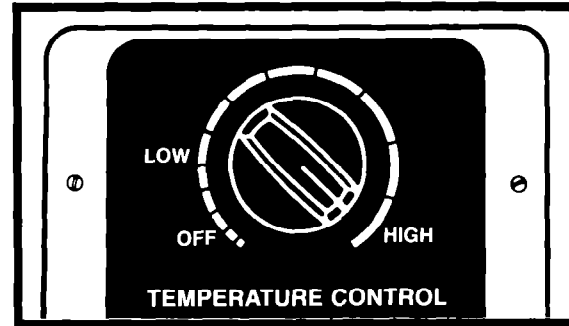

2. Plug unit in and turn the temperature control clockwise to HIGH. Maximum temperature will be reached in about 15 minutes and your dispenser will be ready to use.

Temperature Control

The water temperature is thermostatically controlled to maintain selected temperature. It can be adjusted from "OFF" to approximately 190°. However, under certain conditions, it is possible for the water to boil when the temperature control is set on "HIGH." If you see any vapor or hear boiling, simply lower the temperature control as necessary.

To raise or lower the temperature, turn the temperature control knob. The highest setting is recommended for best performance.

Dispensing Hot Water

Turn the ON-OFF Cap **clockwise** and hold until desired amount of hot water is obtained. The flow of water will increase as cap is turned clockwise. For maximum flow, turn cap until it stops. Release the ON-OFF Cap to turn off.

Hot Water Dispenser Uses

Regardless of what meal or food you're preparing, you'll appreciate the convenience and time saved by your Whirlpool Hot Water Dispenser. The dispenser allows you to draw the amount of hot water you require (up to 2 quarts at one time). It eliminates the need to heat a full teakettle for a cup of hot water.

Preparing Instant Foods and Drinks

Instant foods that only require 190° water for complete preparation include:

- coffee
- tea
- hot chocolate
- soup or bouillon
- mashed potatoes
- instant cereal
- frosting mix

Cooking Short Cuts

190° water will give you a fast start for any food you cook that requires boiling water such as:

- packaged dinners
- fresh or frozen vegetables
- dried soup
- meat cooked in liquid
- hot cereals
- pasta and rice
- boiling eggs

Other Uses

- loosening jar lids
- warming baby bottles and baby food
- filling hot water bottles
- peeling tomatoes or peaches
- dissolving gelatin
- thawing frozen foods
- preparing vegetables for canning

WHIRLPOOL® HOT WATER DISPENSER WARRANTY

LENGTH OF WARRANTY	WHIRLPOOL WILL PAY FOR
FULL ONE-YEAR WARRANTY From Date of Purchase	Replacement parts and repair labor to correct defects in materials or workmanship. Service must be provided by a franchised TECH-CARE® service company.
WHIRLPOOL WILL NOT PAY FOR	
<p>A. Service calls to:</p> <ol style="list-style-type: none"> 1. Correct the installation of the Hot Water Dispenser. 2. Instruct you how to use the Hot Water Dispenser. 3. Replace house fuses or correct house wiring. <p>B. Repairs when Hot Water Dispenser is used in other than normal, single-family household use.</p> <p>C. Pick up and delivery. This product is designed to be repaired in the home.</p> <p>D. Damage to Hot Water Dispenser caused by accident, misuse, fire, flood, or acts of God or use of products not approved by Whirlpool.</p>	

WHIRLPOOL CORPORATION SHALL NOT BE LIABLE FOR INCIDENTAL OR CONSEQUENTIAL DAMAGES. Some states do not allow the exclusion or limitation of incidental or consequential damages so this limitation or exclusion may not apply to you. This warranty gives you specific legal rights, and you may also have other rights which vary from state to state.

Outside the United States, a different warranty may apply. For details, please contact your franchised Whirlpool distributor or military exchange.



Part No. 3177000
 ©1987 Whirlpool Corporation

Printed in U.S.A.

Refrigerators, Dishwashers, Built-In Ovens and Surface Units, Ranges, Microwave Ovens, Trash Compactors, Room Air Conditioners, Dehumidifiers, Automatic Washers, Clothes Dryers, Freezers, Refrigerators

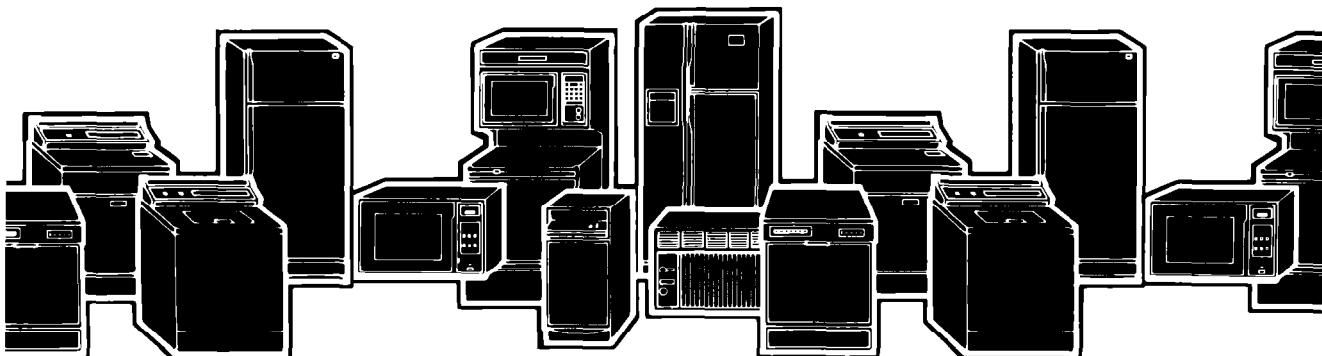

Free Manuals Download Website

<http://myh66.com>

<http://usermanuals.us>

<http://www.somanuals.com>

<http://www.4manuals.cc>

<http://www.manual-lib.com>

<http://www.404manual.com>

<http://www.luxmanual.com>

<http://aubethermostatmanual.com>

Golf course search by state

<http://golfingnear.com>

Email search by domain

<http://emailbydomain.com>

Auto manuals search

<http://auto.somanuals.com>

TV manuals search

<http://tv.somanuals.com>