



WHITE-RODGERS

COMFORT-SET 90[®] SERIES

HEAT PUMP INSTALLATION/CONFIGURATION

INSTALLATION

DESCRIPTION

This White-Rodgers Automatic Setback Digital Thermostat uses microcomputer technology to provide precise time and

temperature control. This thermostat offers the flexibility to design heating and cooling programs that fit building needs. This

thermostat is adaptable to most 24 volt residential forced air heat pump systems with electric or fossil fuel auxiliary.

SPECIFICATIONS

1F94-371: 7 Day programming; residential applications

ELECTRICAL DATA

Electrical Rating:

20 to 30 VAC, 50/60 Hz with common
0.05 to 1.5 Amps per terminal
2.5 Amps maximum total load (all terminals combined)

Standard Systems:

Single-stage or two-stage compressor heat pump.

THERMAL DATA

Setpoint Temperature Range:

45° to 99°F (7° to 37°C)

Operating Ambient Temperature:

32° to 110°F (0° to 43°C)

Operating Humidity Range:

90% non-condensing max.

Shipping Temperature Range:

-4° to 149°F (-20° to 65°C)

PRECAUTIONS

⚠ WARNING

Do not short out terminals on gas valve or primary control to test. Short or incorrect wiring will damage thermostat and could cause personal injury and/or property damage.

Do not use on circuits exceeding specified voltage. Higher voltage will damage thermostat and could cause shock or fire hazard.

Thermostat installation and all components of the system shall conform to Class II circuits per the NEC code.

⚠ CAUTION

To prevent electrical shock and/or equipment damage, disconnect electric power to system at main fuse or circuit breaker box until installation is complete.

NOTE

Read all instructions thoroughly before beginning installation.

This thermostat is intended for use with a low voltage system. Do not use on a line voltage system.

Do not exceed ratings shown in the Specifications section, above. If in doubt about the electrical ratings of your heating/cooling system, have it inspected by a qualified heating and air conditioning contractor or licensed electrician.

All wiring must conform to local and national electrical codes and ordinances.

This control is a precision instrument, and should be handled carefully. Rough handling or distorting components could cause the control to malfunction.

Part No. 37-6186B

Replaces 37-6186A

0121

INSTALLATION

ATTENTION!

This product does not contain mercury. However, this product may replace a unit which contains mercury.

Do not open mercury cells. If a cell becomes damaged, do not touch any spilled mercury. Wearing nonabsorbent gloves, take up the spilled mercury and place into a container which can be sealed. If a cell becomes damaged, the unit should be discarded.

Mercury must not be discarded in household trash. When the unit this product is replacing is to be discarded, place in a suitable container and return to White-Rodgers at 9797 Reavis Road, St. Louis, MO, 63123-5398 for proper disposal.

REMOVE OLD THERMOSTAT

Shut off electricity at main fuse or circuit breaker box until installation is complete **AND** the new thermostat is configured properly.

Remove the front cover of the old thermostat. With wires still attached, remove wall plate from the wall.

Identify each wire attached to the thermostat using one of the labels enclosed with the new thermostat.

Disconnect the wires from the old thermostat one at a time. **DO NOT** let the wires fall back into the wall.

Install the new thermostat using the following procedures.

ATTACH BASE TO WALL

Remove packing material from the thermostat. Place fingers of one hand on the center top and bottom portion of the thermostat. Grasp the base in the other hand on top and bottom center and gently pull straight out. Forcing or prying on the thermostat will cause damage to the unit.

Place the base over the hole in the wall where the wires come out and mark mounting hole locations using the base as a template. Drill $\frac{3}{16}$ " pilot holes, and install screw anchors in the wall.

Run wires through hole in base and attach base to wall (see fig. 1).

Insert the labeled wires into the appropriate terminals on the base and tighten the terminal screws.

CONFIGURING AND PROGRAMMING

Before the power is turned on, the thermostat must be configured to operate properly with the system. See the CONFIGURATION section of this manual.

This thermostat can be programmed for automatic temperature control. Refer to Operating Instructions for programming.

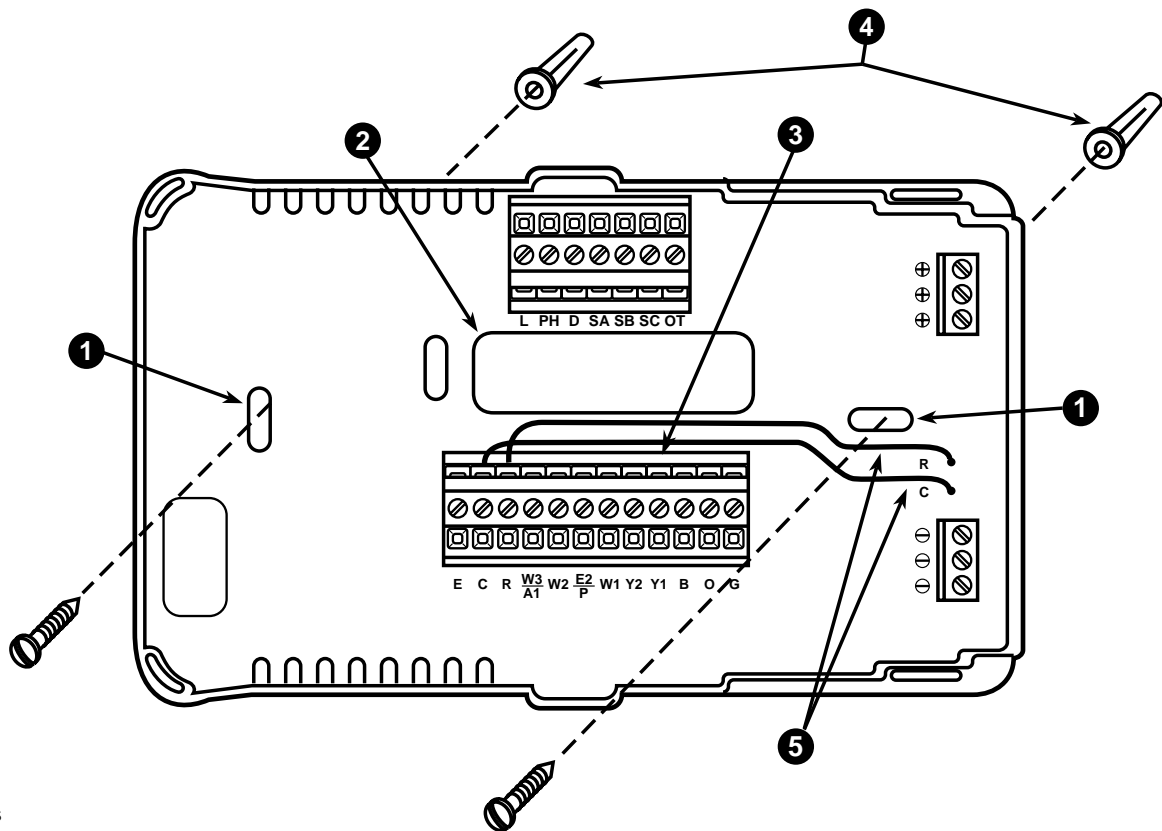

- 1 Mounting screws
- 2 Pull wires through this opening
- 3 Insert wires into terminal holes, then tighten screws
- 4 Screw anchors
- 5 Jumper connections for remote sensor power (Do not remove)

Figure 1. Thermostat base and terminals

HEAT PUMP TERMINAL OUTPUTS

Refer to equipment manufacturers' instructions for specific system wiring information.

You can configure the thermostat for use with the following heat pump system types:

HEAT PUMP TYPE 1. Single-stage compressor system; gas or electric backup.

HEAT PUMP TYPE 2. Multi-stage or two-compressor system; gas or electric backup.

HEAT PUMP TYPE 3. System requiring separate signals for heat (**W1, W2, W3**) and cool (**Y1**); gas or electric backup.

This thermostat is designed to operate a single-transformer system. If you have a two-transformer system, cut and tape off one transformer. If transformer safety circuits are in only one of the systems, remove the transformer of the system with NO safety circuits. If required, replace remaining transformer with a 75VA Class II transformer. After disconnecting one transformer, the two commons must be jumpered together.

Use the terminal output information below to help you wire the thermostat properly for your heat pump system type. After wiring, see **CONFIGURATION** section for proper thermostat configuration.

THERMOSTAT TERMINALS (Upper)						
L	PH	D	SA	SB	SC	OT
Malfunction Light	X-10 Module Input	Not Used	Remote Sense A	Remote Sense B	Remote Sense C	Outdoor Sensor

THERMOSTAT TERMINALS (Lower)												
SYSTEM	E	C	R	W3/A1	W2	E2/P	W1	Y2	Y1	B	O	G
Single-stage compressor system; gas or electric backup												
Heat Pump 1*	Emergency mode first stage	24 Volt (Common)	24 Volt (Hot)	Emergency mode 3rd stage	Heat mode 3rd stage. Emergency mode 2nd stage.	E2 - Emergency mode constant output. P - All other modes constant output.	Heat mode 2nd stage	No Output	Heat and cool modes 1st stage (compressor)	Energized in Heat, Off, Emergency Mode	Energized in Cool Mode	Blower/Fan Energized on call for Heat and Cool
Multi-stage or two compressor system; gas or electric backup												
Heat Pump 2*	Emergency mode first stage	24 Volt (Common)	24 Volt (Hot)	Emergency mode 3rd stage	Emergency mode 2nd stage.	E2 - Emergency mode constant output. P - All other modes constant output.	Heat mode 3rd stage	Heat and cool modes 2nd stage (compressor 2)	Heat and cool modes 1st stage (compressor 1)	Energized in Heat, Off, Emergency Mode	Energized in Cool Mode	Blower/Fan Energized on call for Heat and Cool
System requiring separate signals for heat (W1, W2) and cool (Y1); gas or electric backup												
Heat Pump 3**	Emergency mode first stage	24 Volt (Common)	24 Volt (Hot)	Heat mode 3rd stage. Emergency mode 3rd stage	Heat mode 2nd stage. Emergency mode 2nd stage	E2 - Emergency mode constant output. P - All other modes constant output.	Heat mode 1st stage	No Output	Cool mode 1st stage	Energized in Heat, Off, Emergency Mode	Energized in Cool Mode	Blower/Fan Energized on call for Heat and Cool

* If system does not provide connection to E, jumper W1 to E to provide Aux heating in emergency mode.

** If system does not provide connection to E, jumper W2 to E to provide Aux heating in emergency mode.

CONFIGURATION

SWITCHES

RESET SWITCH

See the **Troubleshooting** section at the end of this document for more information about the function of this switch.

E2/P SWITCH

The **E2/P** switch is located on the back of the thermostat body (see fig. 2). This switch controls how the **E2/P** terminal of the thermostat will be energized. When the switch is in the **E2** position (down), the **E2/P** terminal will be energized only when in emergency heat. When the switch is in the **P** position (up), the **E2/P** terminal will always be energized **except** when in emergency heat. Consult the equipment manufacturer or a qualified heating/cooling service person before setting this switch. If your system has no connection to **E2/P**, no change in the switch setting is required.

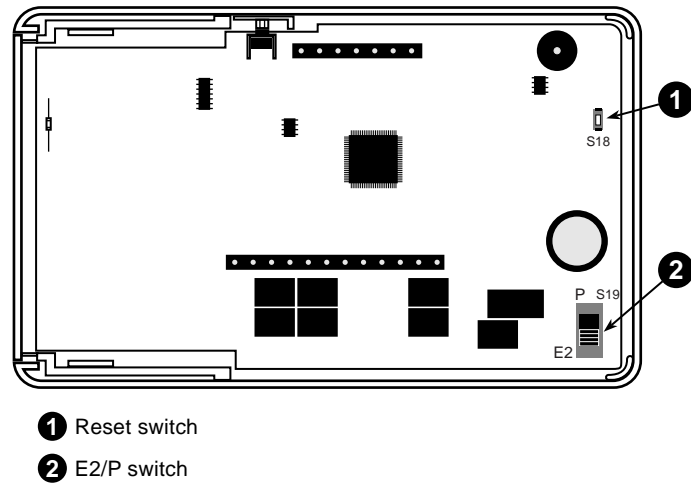

Figure 2. Switch locations on back of thermostat body

INSTALLER CONFIGURATION

BEFORE TURNING POWER ON, please read the following instructions. Before operating the system, you must configure the thermostat to operate properly with your equipment.

The thermostat, as it comes from the factory, is configured to operate a **standard single stage heat pump system**. In this configuration, the thermostat will turn on the fan immediately on a call for heat. If you are unsure whether your system requires the thermostat to control the fan, contact your furnace/air conditioning system manufacturer or a qualified heating/air conditioning service person.

Your new thermostat has an **Installer menu**, which allows you to customize the thermostat to meet your requirements. (The thermostat also has a **User menu** and a **Keypad Lockout menu**. These menus are explained further in the Operating Instructions.)

The menu settings can be changed at any time to meet system or personal requirements.

ENTERING THE CONFIGURATION MENUS.

After properly wiring the thermostat, turn on power to the system. Momentarily press **PROGRAM** (RUN) to make certain the thermostat is in the run program mode, then press **TIME** (FWD) and **TIME** (BACK) at the same time to enter the User Configuration menu. When the display changes to the first item in the configuration menu, release the

buttons. Then press and hold **SET** (TIME) and **SET** (DAY) for approximately 3 seconds to enter the **Installer menu**. The display will change to show the first item on the Installer menu (multi-stage/heat pump selection). Use the following text, along with the **Installer table** on page 5, to guide you through the menu.

Once in the menu, you set each item to the proper selection using **▲** or **▼**, then momentarily press **TIME** (FWD) to change the display to the next step or **TIME** (BACK) to return to the previous item.

To exit the menu at any time and return to program operation, press **PROGRAM** (RUN).

HEAT PUMP COMPRESSOR CONFIGURATION.

(Installer table step 1) Use this item to select the number of heat pump compressors and how they are connected.

ELECTRIC HEAT FAN CONFIGURATION.

(Installer table step 2.) This menu item determines whether fan control will be through the thermostat or through the heating system. If you have an electric heat or other system that **REQUIRES** the thermostat to control the fan, set this item ON. This allows the thermostat to energize the fan immediately on a call for heat. If you are unsure if the system requires the thermostat to control the fan, contact the equipment manufacturer

or a qualified heating and air conditioning service person. If your system controls fan operation (as with most fossil fuel systems), set this item to OFF. Note that with heat pump systems, the fan always cycles with the compressor.

SET CYCLE HEAT, COOL, AUX (ANTICIPATION).

(Installer table steps 3 through 5). These items allow the cycle times in heating, cooling and auxiliary to be increased or decreased. The factory set values can be adjusted higher for longer cycles or lower for shorter cycles.

NOTE: Some manufacturers still instruct you to set the anticipator to the current draw of the equipment. That instruction applies only to mercury bulb or mechanical thermostats; it does not apply to this digital thermostat. As configured at the factory, this thermostat will maintain an accurate temperature. **No further adjustment is necessary**, although you can use these menu items to customize the performance of the thermostat to your requirements.

The adjustment range for HEATING is from 9 to 40 for heat pump. The factory preset is 13. The adjustment range for COOLING is from 9 to 40. The factory preset is 13. The heating and cooling settings will not go below 9 because compressors require a longer cycle. The adjustment range for AUXILIARY is from 1 to 40. The factory preset is 6.

(Continued on page 6)

INSTALLER TABLE

NOTE: You must be in the User Configuration Menu to enter the Installer Menu. Press TIME **FWD and TIME **BACK** at same time.**

Step	Press Button(s)	Displayed (Factory Default)	Press ▲ or ▼ to select:	COMMENTS	See Page
1	SET TIME and SET DAY (hold for approx. 3 seconds)	HEAT PUMP (1)	2 OR 3	Selects: 1. one compressor on Y1. 2. two compressors on Y1, Y2. 3. one compressor on W1.	4
2	TIME FWD	ELECT HEAT FAN (ON)	OFF	Fan cycles with call for Emergency heat if ON. Fan always cycles with pump stages.	4
3	TIME FWD	SET CYCLE HEAT (13)	9 to 40	Selects HEAT anticipation adjustment.	4
4	TIME FWD	SET CYCLE COOL (13)	9 to 40	Selects COOL anticipation adjustment.	4
5	TIME FWD	SET CYCLE AUX (06)	1 to 40	Selects AUXILIARY stage anticipation adjustment.	4
6	TIME FWD	COOL FAN DELAY OFF (00)	0 to 127 seconds	Selects time delay for COOL fan OFF.	6
7	TIME FWD	FAN DELAY ON (01)	1 to 30 seconds	Selects time delay for fan ON for compressor stages.	6
8	TIME FWD	HEAT FAN DELAY OFF (00)	0 to 127 seconds	Selects time delay for HEAT fan OFF in Emergency mode only when ELECT HEAT FAN (Step 2) is ON.	6
9	TIME FWD	PUMP (ON)	OFF	Fossil Fuel Kit Alternative option. Turns compressor OFF if Auxiliary is ON for longer than one minute. (Heat Pump 1 & 2)	6
10	TIME FWD	COMP LOCK (OFF)	ON	Selects compressor short-cycle protection enabled or OFF.*	6
11	TIME FWD	ECON (OFF)	ON	Economizer option. Long Y1 cycles for cooling with outdoor air	6
12	TIME FWD	HEAT-EMER-OFF-COOL-AUTO	HEAT-EMER-OFF-COOL	Allows selection of HEAT, EMER and COOL or HEAT, EMER, COOL and AUTO with SYSTEM button.	6
13	TIME FWD	REMT SEN A (OFF)	ON	Selects Remote Sensor A (connected to SA) if ON.	6
14	TIME FWD	REMT SEN b (OFF)	ON	Selects Remote Sensor B (connected to SB) if ON.	6
15	TIME FWD	REMT SEN C (OFF)	ON	Selects Remote Sensor C (connected to SC) if ON.	6
16	TIME FWD	STAT SEN L (ON)	OFF	When OFF, disables local sensor if a remote sensor is enabled.	7
	PROGRAM RUN			Returns to normal operation	

* **NOTE:** COMP LOCK OFF permanently defeats compressor lockout. **You must turn this selection ON if you do not have a system that already provides compressor short-cycle protection.** Please see "Lockout Bypass Option" to temporarily override compressor lockout.

The chart below shows how this adjustment range affects thermostat performance.

PROGRAMMABLE COOL FAN-OFF AND FAN-ON DELAY.

(Installer table steps 6 and 7.) These items allow a selection of 0 to 127 seconds of fan-off delay after the thermostat has satisfied the call for cool, or a fan-on delay of 1 to 30 seconds on a call for cool (or heat pump compressor activation).

The fan-off delay allows the fan to continue running after the compressor has shut off. This distributes the cool air that would otherwise stay trapped in the air conditioning coils through the ducts. Ideally the timing would be set so the fan shuts off just as the cool air is exhausted. If this timing is set *too* long the fan may begin blowing warm air before it shuts off. Shortening the fan-off delay will prevent this.

A short delay to allow the A-coil to cool off (or warm up in heat pump) before the fan turns on may be preferred. This also allows the compressor and the fan to come on at slightly different times, which allows full power to the compressor on start up. Recommended setting for fan-on delay is 10 seconds or less. A system that does not have a high head pressure cutout should have a delay of 10 seconds or less.

PROGRAMMABLE HEAT FAN-OFF DELAY.

(Installer table step 8.) This item allows a selection of 0 to 127 seconds of fan-off delay after the thermostat has satisfied the call for heat when ELECT HEAT FAN is selected ON and system is in Emergency mode.

The fan-off delay allows the fan to continue running after the burner, heating element, etc. has shut off. This distributes the heat that would otherwise stay trapped in the ducts. Ideally the timing would be set so the fan shuts off just as the warm air is exhausted. If this timing is set *too* long the fan may begin blowing cool air before it shuts off. Shortening the fan-off delay will prevent this.

PUMP (FOSSIL FUEL KIT ALTERNATIVE).

(Installer table step 9) This item controls heat pump compressor operation with a fossil fuel auxiliary. This menu item may eliminate the

need for a separate fossil fuel kit, although we recommend that you consult the heat pump system manufacturer before using this feature instead of a kit. This item will allow the thermostat to turn the heat pump compressor off if the auxiliary is on for more than one minute, to prevent compressor head pressure from getting too high. To use this feature instead of a kit, select PUMP OFF.

COMPRESSOR LOCKOUT.

(Installer table step 10). This thermostat is capable of protecting the system against premature compressor failure by “locking out” the compressor for at least five minutes after each cycle. When the thermostat is in compressor lockout, the word COOL will flash on the display. With heat pump systems, the word HEAT will flash if the lockout occurs during a heat cycle. During this period, the compressor will not be energized.

If the **system** has short-cycle protection, this item should not need to be enabled. However, **if your system does not have short-cycle protection, turn COMP LOCK ON.** This will protect the compressor from short-cycling and potential premature compressor failure.

Note that COMP LOCK OFF **permanently** disables compressor lockout. If you need to **temporarily** disable compressor lockout, please see **Lockout Bypass Option.**

Lockout Bypass Option

FOR QUALIFIED SERVICE TECHNICIANS' USE ONLY. HOMEOWNERS SHOULD NOT USE THIS FEATURE DUE TO POSSIBILITY OF EQUIPMENT OR PROPERTY DAMAGE, OR PERSONAL INJURY.

COMPRESSOR SHORT TERM CYCLE PROTECTION

If this thermostat has been configured to provide short-cycle protection, during the 5-minute lockout period the thermostat will lock out the compressor to allow head pressure to stabilize. To override this feature for one cycle while testing thermostat operation, press **SET** **TIME** and **SET** **DAY** buttons at the same time.

ECONOMIZER FEATURE.

(Installer table step 11). This item allows longer Y1 cycles for cooling with outdoor air.

DISABLING AUTOMATIC CHANGEOVER MODE.

(Installer table step 12). This thermostat, as configured at the factory, provides automatic changeover, which allows the thermostat to switch between heating and cooling to maintain temperature. In this configuration, when you press the SYSTEM button, the thermostat will go through HEAT-EMER-OFF-COOL-AUTO. Select HEAT-EMER-OFF-COOL to disable the automatic changeover feature.

OPTIONAL REMOTE TEMPERATURE SENSE.

(Installer table steps 13 through 15). Up to three remote sensors (part # F145-1328) can be attached to this thermostat to sense indoor temperature at locations away from the thermostat. Each sensor may be located as far as 200 feet away from the thermostat.

This is an excellent feature if the thermostat is in a poor location for sensing temperature or if you want to install the thermostat in a separate room to prevent tampering. (Refer to the installation instructions included with the remote sensor for proper installation and wiring.) After installing and connecting the remote sensor(s) to the thermostat, use these menu items to enable each remote indoor temperature sensor (A, b and/or C). Note that if SENSOR A, b or C are set to ON in the menu, but no sensor is installed, or if the sensor is not functioning, when you exit the menu, **CHECK STAT SYSTEM** will be displayed. To correct this, check for proper remote sensor installation and wiring. If necessary, return to the menu and be sure that the remote sensor items are set correctly.

The temperature at each remote sensor can be displayed by pressing the light button twice within one second with the thermostat in program run or hold mode. Temperatures at the outdoor and indoor remote sensors will be displayed with subsequent presses of the light button in the following order (if connected): outdoor sensor, sensor L, A, b, C.

(Continued on page 7)

Anticipation Value	HEATING		COOLING	
	Cycle Length	Differential Temperature	Cycle Length	Differential Temperature
1-8	Aux Only	0.4-0.6°F (0.2-0.3°C)	N/A	N/A
9-20	Shorter	0.6-1.0°F (0.3-0.6°C)	Shorter	0.6-1.0°F (0.3-0.6°C)
21-40	Longer	1.0-1.6°F (0.6-0.9°C)	Longer	1.0-1.6°F (0.6-0.9°C)

These numbers are approximate and represent operation with a typical system. Actual temperature differentials and run times may vary widely based on your building and equipment, as well as outdoor temperature conditions.

(Installer table step 16). If you wish to sense indoor temperature using ONLY the remote sensor(s), use this menu item to disable the temperature sensor in the thermostat (designated as the L sensor).

When operating with remote sensor(s), the thermostat will calculate an average of the sensed temperatures in all enabled sensor locations (A, B, C and/or L), then display the average temperature as the room temperature. During programming, you can also assign each enabled sensor different priorities during different program periods. This allows the system to maintain a comfortable environment by giving higher priority to occupied locations. At the same time, efficient system operation is enhanced by giving lower priority to unoccupied locations. For detailed instructions on this feature, see the Operating Instructions.

After using the **Installer menu** to properly configure the thermostat for your system, press **PROGRAM** **RUN**.

OUTDOOR TEMPERATURE SENSE.

This thermostat can also display outdoor temperature, if you install an outdoor remote temperature sensor with an outdoor temperature sensor probe (F145-1378). Refer to the remote sensor installation instructions for proper installation and wiring. Refer to the Operating Instructions to enable this feature and display outdoor temperature on the thermostat.

OPTIONAL ACTIVATE RUN PRG BY TELEPHONE

With the optional X-10 Telephone Responder (Model TR551, Radio Shack catalog RSU# 10037778) and Universal Low Voltage Module (UM506, Radio Shack catalog RSU# 10037752) installed, you can make a telephone call to run your program if the thermostat has been set to Hold or Vacation Hold. Figure 3 shows typical wiring connections for installing the X-10 equipment. The switch on the Universal Low Voltage module must be set to the "Momentary" position.

This option must be enabled on the User menu (see Operating Instructions).

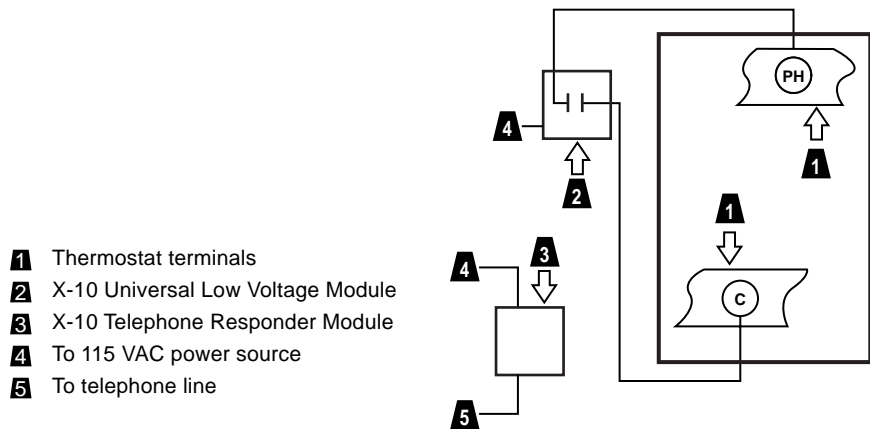

Figure 3. Optional X-10 connection

CHECK THERMOSTAT OPERATION

FAN OPERATION

If your system **does not** have a **G** terminal connection, skip to "Heating System" section.

1. Turn power on to the system.
2. Press **PROGRAM** **RUN**.
3. Press **FAN** until **FAN ON** is displayed. The fan should begin to operate.
4. Press **FAN** until **FAN AUTO** is displayed. The fan should stop operating.

HEATING SYSTEM

1. Press **PROGRAM** **RUN**.
2. Press **SYSTEM** until **HEAT** is displayed. If the heating system has a standing pilot, ensure that it is lit.
3. Press **▲** to adjust thermostat setting above room temperature. The heating system should begin to operate.
4. Press **▼** to adjust temperature below room temperature. The heating system should stop operating.

COOLING SYSTEM

CAUTION
 To prevent compressor and/or property damage, if the outdoor temperature is below 50°F (10°C), DO NOT operate the cooling system.

1. Press **PROGRAM** **RUN**.
2. Press **SYSTEM** until **COOL** is displayed.
3. Press **▼** to adjust thermostat setting below room temperature. The fan should come on (after the fan-on delay time, if any), followed by cold air circulation.
4. Press **▲** to adjust temperature setting above room temperature. The cooling system should stop operating, and the fan should stop running (after the fan-off delay time, if any).

HEAT PUMP AUXILIARY OPERATION TEST

Follow these steps to energize all stages of heat or cool to permit system checks during installation.

HEAT: Press **▲** to raise temperature setting to 99°F, then hold for five seconds. The second and third stage heat relays will energize immediately for test purposes. The LED indicator will glow green for first stage and yellow for second stage.

COOL: Press **▼** to lower temperature setting to 45°F, then hold for five seconds. The second stage cool relay will energize immediately for test purposes. The LED indicator will glow green for first stage and yellow for second stage.

EMERGENCY: Press **SYSTEM** to select **EMER** mode. The LED indicator will glow red for emergency mode. A flashing light indicates a malfunction in the system.





TROUBLESHOOTING

RESET BUTTON

If the thermostat does not respond when keys are pressed, or the thermostat is not operating properly, you may use the reset button located on the back of the thermostat body (see fig. 2). Thermostat programming and configuration will **not** be affected by pressing the reset button. However, the clock will need to be reset.

RESETTING THERMOSTAT CONFIGURATION AND PROGRAMMING

The thermostat can be reset back to default programs and configuration. Removing power from the thermostat **will not** reset it, because the default settings are maintained in permanent memory. **Before resetting the thermostat**, you may want to make note of the previously selected configuration and programming. **You must reconfigure and reprogram the thermostat after resetting it using this method.**

To reset the thermostat, press and release **PROGRAM** , then press the **FAN** , **TIME**  and  buttons at the same time. This will reset the thermostat to factory default programs and configuration. The display will momentarily go blank, then all segments on the display will momentarily be shown. The thermostat will then go into the **HOLD** mode and will maintain factory preset temperatures.



WHITE-RODGERS
EMERSON ELECTRIC CO.
9797 REAVIS ROAD
ST. LOUIS, MISSOURI 63123-5398
www.white-rodgers.com



Free Manuals Download Website

<http://myh66.com>

<http://usermanuals.us>

<http://www.somanuals.com>

<http://www.4manuals.cc>

<http://www.manual-lib.com>

<http://www.404manual.com>

<http://www.luxmanual.com>

<http://aubethermostatmanual.com>

Golf course search by state

<http://golfingnear.com>

Email search by domain

<http://emailbydomain.com>

Auto manuals search

<http://auto.somanuals.com>

TV manuals search

<http://tv.somanuals.com>