

OPERATION GUIDE

1F90-71

5 Day/2 Day Electronic
Digital Thermostat



WHITE-RODGERS

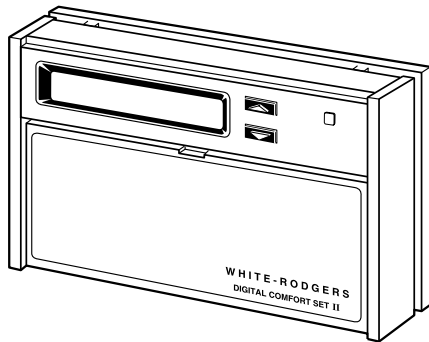

Operator: Save this booklet for future use!

About Your New Thermostat . . .

Your new White-Rodgers Digital Thermostat uses the technology of a solid-state microcomputer to provide precise time/temperature control. This thermostat offers you the flexibility to design heating and cooling programs that fit your needs.

Please read this manual thoroughly before operating or programming your thermostat. If you have questions, write to us at the address shown on the back cover of this manual.

In This Guide . . .

YOUR NEW THERMOSTAT'S

FEATURES 4

OPERATING YOUR THERMOSTAT 5

PARTS OF THE THERMOSTAT

The Back Of the Thermostat Body

The Display

The Thermostat Buttons

OPERATING FEATURES

PROGRAMMING YOUR

THERMOSTAT 19

PLANNING FOR YOUR NEEDS

ENTERING YOUR PROGRAM

Set Current Time and Day

Enter Heating Program

Enter Cooling Program

CHECK YOUR PROGRAMMING

QUESTIONS AND ANSWERS 29

**Operator: Save this
booklet for future use!**

YOUR NEW THERMOSTAT'S FEATURES

- Separate 5-day (weekday) and 2-day (week-end) setback programming
- Simultaneous heat and cool program storage
- Four separate time/temperature settings per 24-hour period
- Computed Energy Management Recovery (EMR)
- Automatic changeover (operator-selectable)
- Armchair programming capability
- Backlit LCD displays continuous set point, time, and room temperature
- 1.5 volt "AA" Energizer® alkaline battery backup
- Preprogrammed temperature control
- Adjustable cycle times
- Compressor short cycle protection
- Programmable blower control
- Blower delay in the cooling cycle
- Audio and visual prompting during operation
- Two hour temperature override
- Manual program override (HOLD temperature)
- "Advance Program" key
- °F/°C convertibility
- Keypad lockout and limited temperature range (operator-selectable)
- Temperature range 40° to 99°F
- Compatible with Remote Sensor (installer-selectable)

OPERATING YOUR THERMOSTAT

Before you begin programming your thermostat, you should be familiar with its features and with the display and the location and operation of the thermostat buttons. The information in this section will help you become familiar with your new thermostat so that you can easily program it.

Your thermostat consists of two parts: the **thermostat body** and the **subbase**.

CAUTION

Remove power from the system at the circuit breaker/fuse box before removing or attaching the thermostat body. Equipment damage and/or personal injury could occur.

The subbase is attached to the wall, but you can remove the thermostat body for easy programming. To remove the thermostat body from the subbase, grasp the thermostat body and gently pull it straight out from the subbase. To attach the thermostat body, line up the three terminal pins on the lower section of the thermostat back with the matching connector on the subbase. Insert these, then gently pivot the thermostat body up to connect the six pin connectors on the upper portion of the thermostat back. Gently push until the snap connectors engage. **DO NOT FORCE OR PRY THE THERMOSTAT**, as this may damage the unit.

PARTS OF THE THERMOSTAT

The Back of The Thermostat Body

Turn the thermostat body over. On the back are the 3 “AA” Energizer® alkaline batteries and the two option switch groups (A and B).



1. The “AA” Energizer® alkaline batteries provide power to the thermostat when the 24 VAC power is interrupted (for example, when you remove the thermostat from the wall for programming). Fresh batteries will maintain the stored program for approximately a year. If power loss is long enough for the program to be lost, the thermostat will automatically return to the factory programmed temperatures (64°F heating and 82°F cooling) when power is restored. You must reprogram the thermostat if this happens.

If the word **BATTERY** is flashing in the display window, the batteries are low and should be replaced with fresh “AA” Energizer® alkaline batteries.

CAUTION

Use  to turn the thermostat **OFF** before removing the thermostat from the wall to replace batteries.

2. You may adjust the option switches for keypad lockout, limited temperature range, and automatic changeover from heat to cool (see **OPERATING FEATURES**).

Other than  and , the buttons are located behind the thermostat door. To open the door, put your fingernail in the indentation at the top of the door, then pull the door out from the top and swing it down on its hinges.

On the following pages there are brief descriptions of the display and the thermostat buttons.

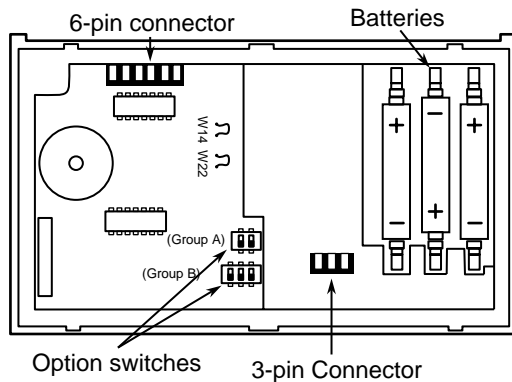



BACK OF THERMOSTAT BODY

The Display

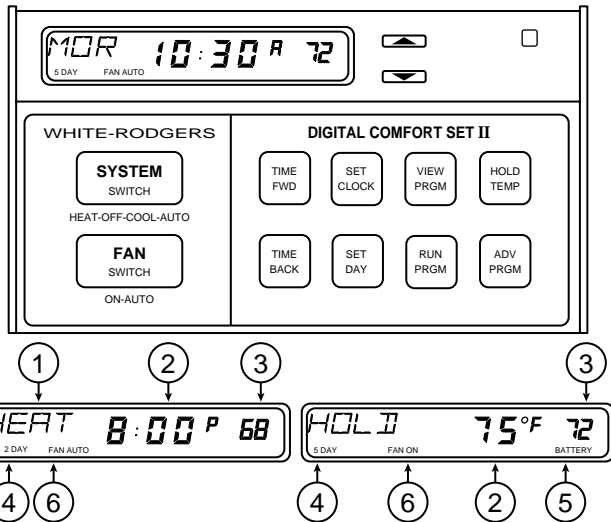
- ① Continuously displays system mode (**HEAT**, **OFF**, **COOL**, **AUTO**, **HOLD**). During programming, the program period is displayed (**MOR**, **DAY**, **EVE**, or **NHT**).
- ② Alternately displays room temperature (**F** denotes degrees Fahrenheit and **C** denotes degrees Celsius) and time of day (**A** denotes AM time and **P** denotes PM time).
- ③ Displays the setpoint temperature.
- ④ **5 DAY** indicates that the displayed program is the weekday program. **2 DAY** indicates that the displayed program is the weekend program.
- ⑤ The word **BATTERY** flashes on the display when the “AA” alkaline batteries are weak and should be replaced. The word **BATTERY** is displayed continuously (non-flashing) when thermostat is running on battery power only.
- ⑥ **FAN ON** is displayed when the blower is operating continuously. **FAN AUTO** is displayed during automatic fan operation (when the blower cycles with the heating or cooling system).



The Thermostat Buttons

- ⑦ Sets the system mode (**HEAT**ing, **OFF**, **COOL**ing, or **AUTO**matic changeover).
- ⑧ Selects fan operation (see #6, above). This button is also used to program the fan to run continuously during a program period.
- ⑨ Runs display forward or backward through time, day, or anticipation settings during programming.
- ⑩ Used with  and  to set current time and day of the week.
- ⑪ Used during programming to set the day of the week to be programmed. Also used in conjunction with  to enter anticipation setting mode.
- ⑫ Used to initiate or review thermostat programming.
- ⑬ Used to start program operation after programming. Also used to return thermostat to program operation after being in **HOLD** mode.
- ⑭ Used to manually override programming to hold at a selected temperature (when **HOLD** is displayed).
- ⑮ Used to advance thermostat program to the next program period (for example, from the **MOR** program to the **DAY** program).
- ⑯ (Red arrow) Raises temperature setting (99°F or 37°C maximum).

①⑦ (Blue arrow) Lowers temperature setting (40°F or 4°C minimum).

①⑧ The red indicator light glows whenever heating, cooling, or fan are in operation.

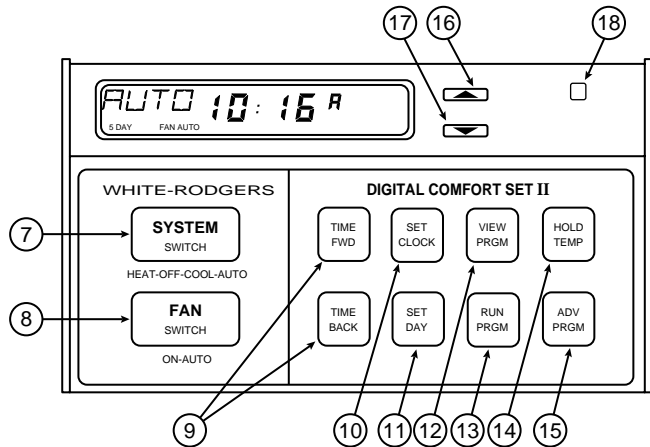

OPERATING FEATURES

Now that you are familiar with the thermostat display and buttons, read the following information to learn about the many features of the thermostat.

- **COMPUTED ENERGY MANAGEMENT RECOVERY (EMR)** — The thermostat's microcomputer can be set to automatically calculate the time it will take to change the temperature to the next program setting. Then the thermostat will activate the heating or cooling system to change the temperature so that the desired temperature is reached at the beginning of the next program period. As an example of this feature, assume that you have programmed your thermostat to provide an overnight heating temperature of 62°F, and that during the

next program period, beginning at 6:00 AM, you have programmed a temperature of 70°F. The thermostat will automatically activate the heating system at about 5:00 AM, so that the programmed 70°F temperature is reached by about 6:00 AM.

This feature is controlled by Group B option switch #3. To **enable** the EMR function, first you must move option switch #3 (located on the back of the thermostat body) to the **OFF** position, if it has not already been done. To do this, turn off 24 VAC power to the thermostat. Then remove the thermostat body from the wall. Check the position of switch #3 (the last switch on the right). If it is **OFF** (down), simply put the thermostat back on the wall and restore 24 VAC power. If the switch is **ON** (up), remove the battery, then use a pencil or small screwdriver to move the

switch to the **OFF** position (see figure below). Leave the battery out of the thermostat for at least **two minutes**, to allow the thermostat to reset itself. See **AUTOMATIC CHANGEOVER** to determine proper positions of Group B option switches #1 and #2.

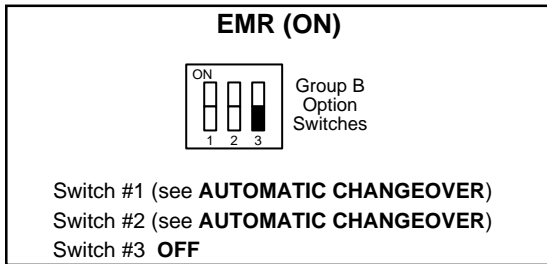

- **AUTOMATIC CHANGEOVER** — If you have a heating/cooling system, you can set the thermostat to automatically switch the system from heating to cooling as needed. (If you have a heating only system, Group B

option switch #1 should be **OFF** and option switch #2 should be **ON**.) To enable automatic changeover, you must move Group B option switch #1 to the **ON** position and switch #2 to the **OFF** position. Turn off 24 VAC power to the thermostat. Then remove the thermostat body from the wall. Check the position of Group B option switches #1 and #2 (the first two switches on the left). If they are in the correct positions, simply put the thermostat back on the wall and restore 24 VAC power. If the switches are not correctly positioned, remove the battery, then use a pencil or small screwdriver to move the switches to the correct positions (see figure on next page). Leave the battery out of the thermostat for at least **two minutes**, to allow the thermostat to reset itself. Replace the battery, reprogram the thermo-

stat, if necessary, put the thermostat back on the wall, and restore 24 VAC power. To set the thermostat for automatic changeover after programming, press  to set the thermostat to **AUTO** (the setpoint temperature display is **blank** in the **AUTO** mode). The system will now automatically switch between heating and cooling, depending on the actual room temperature.

Automatic Changeover

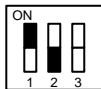

Group B
Option
Switches

Switch #1 **ON**

Switch #2 **OFF**



Switch #3 (see **Energy Management Recovery**)

NOTE

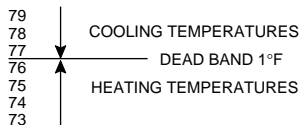



In the **AUTO** mode, the thermostat will not allow the temperature separation between the highest heat setting and the lowest cool setting to be less than 1°F. For example, if the highest heat setting is 76°F, the lowest cool setting cannot be below 77°F (see diagram below).





For manual changeover, Group B option switches #1 and #2 should be in the **OFF** position.

- **TWO HOUR TEMPERATURE OVERRIDE** — Press  or  until the display shows the temperature you want. The

thermostat will override current programming and keep the room temperature at the selected temperature for two hours. After two hours, the thermostat will automatically revert to the program.

- **HOLD TEMPERATURE** — The thermostat can hold any temperature within its range for an indefinite period, without reverting to the program. Press . **HOLD** will be displayed. Then choose the desired hold temperature by pressing  or . The thermostat will hold the room temperature at the selected setting until you press  to start program operation again. This feature is ideal for energy conservation when the building is unoccupied for an extended period of time.

- **“ADVANCE PROGRAM” KEY** — Press  to change the thermostat to the next program period. This will temporarily override the program, until the next program period begins (for example, pressing this key while in the **DAY** program will advance the thermostat to the **EVE** program, which will remain in effect until the **NHT** program begins).
- **°F/°C CONVERTIBILITY** — Press  and  at the same time until the temperature display is in °C (Celsius). To display °F, repeat the process.
- **ADJUSTABLE HEATING AND COOLING CYCLE TIMES (ANTICIPATION)** — If the heating/cooling system is turning on and off too often (short cycles) or not often enough

(long cycles), you may want to adjust the anticipation setting.

! CAUTION

A cooling anticipation setting of less than 10 may cause decreased compressor life.

To adjust **heat** anticipation, press  and

 at the same time. The display will show **HEAT 5** (this is the factory preprogrammed heating anticipation setting). You may select any anticipation setting from 2 to 40 (**note that for hydronic systems, a minimum anticipation setting of 15 is recommended**). Whenever adjusting anticipation, increase or decrease the displayed number by only one or two digits, then let the system run for a while to see if the adjustment is

sufficient. If the heat cycles are too short, press  to increase the cycle time. If the

heat cycles are too long, press  to decrease the cycle time. To set **cooling** antici-

pation, press  and  at the same time

again. The display will show **COOL 14** (factory preprogrammed cooling anticipation).

You may select any anticipation setting from

4 to 40. Use  and  to adjust antici-

pation. Press  to return to your program.

- **LOW BATTERY INDICATOR** — The word **BATTERY** will flash on the display if the “AA” alkaline batteries are low and should be replaced. The word **BATTERY** will be displayed continuously (non-flashing) when

24 VAC power is not being supplied to the thermostat and the thermostat is operating on battery power only.

- **AUDIO PROMPTING** — Each time you press a button, the thermostat will beep.
- **BACKLIT DISPLAY** — When you press any button on the thermostat, the display is lit for approximately eight seconds.
- **SYSTEM INDICATOR LIGHT** — The red light on the upper right part of the thermostat indicates system operation (see **PARTS OF THE THERMOSTAT**).
- **COMPRESSOR SHORT CYCLE PROTECTION** — To protect your compressor from potential damage due to rapid cycling, this thermostat has a built-in delay of 5 minutes between cooling cycles. The following may cause a time delay in **COOL**:
 - a) Return of power after a power outage.

b) Pressing  to change operating modes.

c) Pressing , creating a call for **COOL** too soon after a previous call.

- **TOTAL KEYPAD LOCKOUT**—When Group A option switch #1 is in the total keypad lockout position (**ON**), programs cannot be altered and all buttons are disabled (see next page for illustration).

NOTE

Programming should be completed and batteries should be installed **before** changing Group A option switches #1 or #2.



Total Keypad Lockout

Switch #1 **ON**
Switch #2 **OFF**



Group A
Option
Switches

To **enable** total keypad lockout, move Group A option switch #1 to **ON** (see figure above). To disable total keypad lockout, move option switch #1 to **OFF**.

- **LIMITED TEMPERATURE RANGE** — When Group A option switch #1 is in the **OFF** position and option switch #2 is in the **ON** position, the heating and cooling temperatures may be changed using the  and  buttons, but the temperatures may not be set to exceed **any programmed** maximum heating or minimum cooling temperatures. When this option is set, the following buttons are disabled:

SET
DAY

HOLD
TEMP

ADV
PRGM

NOTE

Programming should be completed and batteries should be installed **before** changing Group A option switches #1 or #2.

Limited Temperature Range

Switch #1 **OFF**
Switch #2 **ON**



Group A
Option
Switches

To **enable** limited temperature range, move Group A switch #1 to the **OFF** position and switch #2 to the **ON** position (see figure below). To disable limited temperature range, move switch #2 to the **OFF** position (see **TOTAL KEYPAD LOCKOUT** to determine the correct position of option switch #1).

PROGRAMMING YOUR THERMOSTAT

Now you are ready to program your thermostat. This section will help you plan your thermostat's program to meet your needs.

For maximum comfort and efficiency, keep the following guidelines in mind when planning your program.

- When heating (cooling) your building, program the temperatures to be cooler (warmer) when the building is vacant or during periods of low activity.
- During early morning hours, the need for cooling is usually minimal.

PLANNING FOR YOUR NEEDS

First, answer the following questions to help you decide what your needs are. If you are using the

thermostat for a commercial application (a store, office building, etc.), answer questions 1 through 4. If you are using the thermostat in your home, answer questions 5 through 8.

FOR COMMERCIAL APPLICATIONS:

- 1a. What time does the first person arrive at the building in the morning?
 - b. What temperature should the building be at this time? (heating? cooling?) These will be your **MOR** (morning) temperature settings.
- 2a. What time do the building occupants reach a maximum activity level (using lights, equipment, meeting rooms, etc.)?
 - b. What temperature should the building be at this time? These will be your **DAY** temperature settings.

- 3a. What time do the building occupants reach a minimum activity level (limited personnel in building)?
- b. What temperature should the building be at this time? These will be your **EVE** (evening) temperature settings.
- 4a. What time does the building become vacant?
- b. What temperature should the building be at this time? These will be your **NHT** (night) temperature settings.

IN YOUR HOME:

- 5a. What time does the first person get up in the morning?
- b. What temperature should the house be at this time? These will be your **MOR** (morning) temperature settings.

- 6a. What time does the last person leave the house in the morning?
- b. What temperature should the house be at this time? These will be your **DAY** temperature settings.
- 7a. What time does the first person arrive home in the evening?
- b. What temperature should the house be at this time? These will be your **EVE** (evening) temperature settings.
- 8a. What time does the last person go to bed at night?
- b. What temperature should the house be at this time? These will be your **NHT** (night) temperature settings.

Now look at the factory preprogrammed times and temperatures shown below. If this program will suit your needs, simply press  to begin running the factory preset program.

If you want to change the preprogrammed times and temperatures, do the following.

NOTE

To operate properly in the **AUTO** mode, there must be a **minimum 1°F separation** between the highest heat temperature and the lowest cool temperature (see diagram at right).

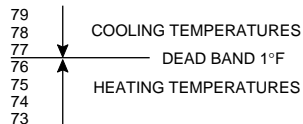

Determine the time periods and heating and cooling temperatures for your weekday program. You must program 4 periods for each day (**MOR**, **DAY**, **EVE**, and **NHT**). However, you may use the same heating and cooling temperatures for consecutive time periods. You can choose start times, heating temperatures, and cooling temperatures independently for both

FACTORY PREPROGRAMMING

Heating Program for ALL days of the Week:

PERIOD	TIME	TEMP
MOR	5:00 AM	70
DAY	9:00 AM	70
EVE	4:00 PM	70
NHT	10:00 PM	64

Cooling Program for ALL Days of the Week:

PERIOD	TIME	TEMP
MOR	5:00 AM	78
DAY	9:00 AM	82
EVE	4:00 PM	78
NHT	10:00 PM	78

Download from Www.Somanuals.com. All Manuals Search And Download.

weekday and weekend programs (for example, you may select 5:00 AM and 70° as the weekday **MOR heating** start time and temperature, and choose 7:00 AM and 76° as the weekday **MOR cooling** start time and temperature). Use the following table to plan your program time periods, and the temperatures you want during each period. You may also want to look at the sample program table to get an idea of how the thermostat can be programmed.

ENTERING YOUR PROGRAM

Follow these steps to enter the heating and cooling programs you have selected.

NOTE

We recommend that you remove the thermostat from the wall for programming (especially for entering cooling programming). Fresh “AA” En-

ergizer® alkaline batteries must be installed to perform off-wall programming. **BE SURE TO USE**  **TO TURN THERMOSTAT OFF BEFORE REATTACHING THERMOSTAT TO SUBBASE!**



NOTE

You cannot program the thermostat with the **SYSTEM SWITCH** in the **AUTO** position.

Set Current Time and Day

1. Press  once. The display will show minutes only.

EXAMPLE: 

2. Press and hold either  or  until you reach the correct minutes.

Heating/Cooling Schedule Plan





	WEEKDAY (5 DAY)		WEEKEND (2 DAY)	
	Start Time	Temperature	Start Time	Temperature
MOR HEAT				
DAY HEAT				
EVE HEAT				
NHT HEAT				
MOR COOL				
DAY COOL				
EVE COOL				
NHT COOL				

SAMPLE Heating/Cooling Schedule Plan

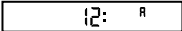
	WEEKDAY (5 DAY)		WEEKEND (2 DAY)	
	Start Time	Temperature	Start Time	Temperature
MOR HEAT	5:30 AM	68°F	7:00 AM	68°F
DAY HEAT	8:00 AM	65°F	11:00 AM	70°F
EVE HEAT	5:00 PM	70°F	6:00 PM	70°F
NHT HEAT	10:30 PM	65°F	11:30 PM	65°F
MOR COOL	6:30 AM	76°F	7:00 AM	76°F
DAY COOL	2:00 PM	78°F	12:30 PM	74°F
EVE COOL	5:00 PM	72°F	6:00 PM	72°F
NHT COOL	10:30 PM	78°F	11:30 PM	78°F



3. Press  once. The display window will show the hour only.



EXAMPLE: 

4. Press and hold either  or  until you reach the correct hour and AM/PM designation (**AM** begins at midnight; **PM** begins at noon).
5. Press  once. The display will show the day of the week as an abbreviation (**MO** for Monday, **TU** for Tuesday, etc.).
6. Press and hold either  or  until you reach the current day of the week.

7. Press  once. The display will show the correct time and room temperature alternately.

Enter Heating Program



During programming, if you don't press any buttons for 5 minutes, the thermostat will enter the **HOLD** mode and will maintain a constant temperature. The display will revert to the alternating time/temperature display. To resume programming after this happens, press  until you are at the point where you stopped programming. Then you may continue to enter your programs normally. If you want to stop programming at any time, simply press  to resume program operation.





1. Press  until **HEAT** is displayed.
2. Press  once. **5 DAY** (indicating weekday program), and **MOR**, representing the **morning** heating period, will appear in the display. Also displayed are the currently programmed start time for the **MOR** period and the currently programmed temperature.

EXAMPLE: 

This display window shows that for the weekday **MOR** period, the start time is 5:00 AM, and 70° is the programmed temperature (this example reflects factory preprogramming).

3. To change the displayed start time to your selected start time for weekday **MOR** heat

program, press  or  until your selected time appears. The time will change in 15 minute increments.

4. Press  or  until you reach your selected weekday **MOR** heating temperature.
5. If you want the fan to run continuously during this period, press  until **PRG FAN** is displayed.
6. Press . The currently programmed start time and heating temperature for weekday **DAY** will be displayed.
7. Repeat steps 3 through 5 to select the start time and heating temperature for the weekday **DAY** program.

8. Repeat steps 3 through 7 for the weekday **EVE** and **NHT** heating programs.
9. After entering your weekday heating program, repeat steps 1 through 8 for your weekend programming (keep in mind that for weekend programming, the display should be changed from **5 DAY** to **2 DAY**).
10. When you have completed entering your heating program, press .

Enter Cooling Program



CAUTION



If outside temperature is below 50°F, we recommend that you remove the thermostat from the wall before proceeding with the following steps to program cooling temperatures. Personal injury or property damage may occur due to air conditioner compressor slugging. Fresh “AA” Energizer® alkaline batteries must be installed to perform off-wall programming. Programming away from the wall should prevent accidental compressor operation. USE  TO TURN THERMOSTAT OFF BEFORE REATTACHING THE THERMOSTAT TO THE SUBBASE!

1. Press  until **COOL** appears.
2. Follow the procedure for entering your heating program, using your selected cooling times and temperatures.



CHECK YOUR PROGRAMMING

Follow these steps to check your thermostat programming one final time before beginning thermostat operation.

1. Press  until **HEAT** is displayed.
2. Press and hold  to view the heating period times and temperatures in sequence for weekday, then weekend **MOR**, **DAY**, **EVE**, and **NHT** program periods.
3. Press .



4. Press  until **COOL** is displayed.
5. Repeat step 2 to check cooling temperatures.
6. Press  to begin program operation.

YOUR THERMOSTAT IS NOW COMPLETELY PROGRAMMED AND READY TO AUTOMATICALLY PROVIDE MAXIMUM COMFORT AND EFFICIENCY!

Press  until **OFF** is displayed. Reattach thermostat to subbase. Turn on power to the system. Then press  to select the operation mode you want (**HEAT**, **COOL**, **AUTO**). Press  until **FAN AUTO** is displayed (automatic cycling).

QUESTIONS AND ANSWERS

1. **How can I permanently change a part of my program?**

Press  until you reach the time/temperature schedule you want. Then press  or

 and  and  to change the program. See **PROGRAMMING YOUR THERMOSTAT**.

2. **How can I have no change in temperature from one time period to another?**

Simply select the same temperature for each consecutive time period. For example, you may select the same weekday **EVE** cooling temperature as you did for weekday **DAY**, which means the temperature will not

change when the **EVE** period begins. See **PROGRAMMING YOUR THERMOSTAT**.

3. **How can I finish my programming if the display has already changed to time/temperature?**

During programming, if no buttons are pressed for five minutes, the thermostat will enter the **HOLD** mode and maintain a constant temperature. The display will change to the time/temperature mode. To resume

programming, press  until you return to the point where you stopped programming. Then you may continue to program the thermostat normally. If you want to stop

programming at this point, press  to start

the normal program function. See **PROGRAMMING YOUR THERMOSTAT**.

4. What happens if the electricity goes off or is manually shut off?

If you have not installed 3 “AA” alkaline batteries, the display will go blank and the program will be lost in approximately one minute. When electricity is restored, the clock will reset itself to 12:00 PM (noon) and the thermostat will maintain a heating temperature of 64°F and a cooling temperature of 82°F until you reenter your program. Setpoint temperature will not be displayed.

If fresh “AA” Energizer® alkaline batteries are installed, the program will be maintained for about one year with no 24 VAC power present to the thermostat. See **OPERATING YOUR THERMOSTAT**.



5. Why can't I program the thermostat in the AUTO mode?

The thermostat can only be programmed in the **HEAT** and **COOL** modes. See **PROGRAMMING YOUR THERMOSTAT**.

6. What can cause the thermostat display to freeze or go blank?

A completely blank display may indicate that power has been lost to the thermostat and the backup battery is also dead. However, if there is power to the thermostat and the display is blank or frozen, static discharge is probably the cause.

During periods of low humidity (especially during cold weather), you may feel or see a spark discharge when you touch the thermostat. This may cause the program to be lost or the thermostat to display incorrectly.

To correct this, remove the thermostat from the wall and disconnect the battery. Wait about one minute, then reconnect the battery. The thermostat will revert to the factory preset program until you reprogram the thermostat. If you don't want to reprogram the thermostat immediately, press  until **OFF** is displayed and replace the thermostat on the wall. Then press  to begin the factory preset program. Or you may reprogram the thermostat, then replace it on the wall.

To prevent further static discharge problems, touch another object to release static build-up before touching the thermostat. See **OPERATING YOUR THERMOSTAT**.

7. Why won't the setpoint temperature go to the temperature I want?

In the **AUTO** mode, the highest heating setpoint temperature you select must be at least 1°F lower than the lowest cooling setpoint temperature you select (for example, if 70°F is your lowest selected cooling temperature, you cannot select a heating temperature any higher than 68°F). If such a conflict exists, you must set the lowest cooling temperature higher in order to set the heating temperature higher. To set a lower cooling temperature, you must select a lower heating temperature. See **PROGRAMMING YOUR THERMOSTAT**.

8. The display is flashing BATTERY. What does this mean?

The “AA” batteries installed in the thermostat are low and should be replaced with fresh “AA” Energizer® alkaline batteries. See **OPERATING YOUR THERMOSTAT**.

9. The display shows a continuous (non-flashing) BATTERY. What does this mean?

The thermostat is not being supplied with 24 VAC power. The thermostat is operating on battery power alone. See **OPERATING YOUR THERMOSTAT**.

10. Why won't the compressor turn on, even though the thermostat display is functioning normally?

Either the compressor lockout feature is in operation or the thermostat is not currently

calling for cool. Wait about 5 minutes for the compressor lockout to expire. If the system is still not running, read the cautionary statement below. Then, **if conditions permit**, use the  button to move the temperature below the setpoint temperature. See **OPERATING YOUR THERMOSTAT**.

⚠ CAUTION



If the outside temperature is below 50°F, DO NOT use the  button to move the temperature below the setpoint temperature. Property damage may result due to compressor slugging.

11. Why doesn't the temperature change at the time I programmed?

There may be a number of causes for this situation. The following are primary reasons.

- The **EMR** function is operating. The **EMR** function will automatically bring on the system automatically to bring the temperature to the selected level by the beginning of the next program period. See **OPERATING YOUR THERMOSTAT**.
 - You have programmed the incorrect day or time. Check your programming (be sure that the times you programmed are correct AM or PM times). See **PROGRAMMING YOUR THERMOSTAT**.
 - The thermostat is in the **HOLD** mode. Press  to start program operation. See **OPERATING YOUR THERMOSTAT**.
 - The compressor lockout feature is operating; wait about 5 minutes for system to begin running. See **OPERATING YOUR THERMOSTAT**.
- 12. Why does the blower fan keep running after the system has turned off?**
- You have programmed the fan to run continuously during this period. See **PROGRAMMING YOUR THERMOSTAT**.
 - The blower delay feature is operating. This energy saving feature continues to blow conditioned air through the ducts after the system has turned off, rather than letting the air dissipate.
- 13. Why is the system turning on and off so frequently (seldom)?**
- The anticipation setting is too low (high). To change anticipation settings, see **OPERATING YOUR THERMOSTAT**.

14. Between heating and cooling seasons, I want to turn my system off. Can I do this without affecting my thermostat programming?



Any time you wish to turn your system off, simply press  until the display shows **OFF**. This will not affect your thermostat's programming in any way. To turn the system back on, press  until **HEAT**, **COOL**, etc. is displayed. The system will automatically begin operating according to the current thermostat program, unless the thermostat is in the **HOLD** mode. See **OPERATING YOUR THERMOSTAT**.

15. I live in an area where daylight savings time is observed. How do I change the thermostat clock twice a year without affecting thermostat programming?

To change your clock, follow the instructions for setting current time and day. See **ENTERING YOUR PROGRAM**. Thermostat programming is not affected when you change the clock.

16. Do I have to reprogram my thermostat after I change the batteries?

When the thermostat is on the wall and the system has power, the thermostat is being powered by a 24 VAC source. If power is lost, or if the thermostat is removed from the wall, the program will be retained for approximately **one minute** if there are no batteries installed or if the installed batteries are dead. If you are changing the batteries after seeing a flashing **BATTERY** on the display, the installed batteries may be dead. If you remove the old batteries and install fresh ones within one minute, you should not lose your thermostat programming. After installing new batteries, follow the procedures in **CHECK YOUR PROGRAMMING**

to determine whether your programming was maintained. If the thermostat maintains programming, press  until **OFF** is displayed, put the thermostat back on the wall, press  to select the operating mode you want, then press  to start program operation. If the program is lost, reprogram the thermostat. See **PROGRAMMING YOUR THERMOSTAT**.

If you need further information on programming or operation, write to:

White-Rodgers Division, Emerson Electric Co.
9797 Reavis Road
St. Louis, MO 63123
Attn: Technical Service Department



Part No. 37-5098B

Replaces 37-5098A

9518

Free Manuals Download Website

<http://myh66.com>

<http://usermanuals.us>

<http://www.somanuals.com>

<http://www.4manuals.cc>

<http://www.manual-lib.com>

<http://www.404manual.com>

<http://www.luxmanual.com>

<http://aubethermostatmanual.com>

Golf course search by state

<http://golfingnear.com>

Email search by domain

<http://emailbydomain.com>

Auto manuals search

<http://auto.somanuals.com>

TV manuals search

<http://tv.somanuals.com>