



**USER'S MANUAL**  
MANUEL DE L'UTILISATEUR  
MANUAL DEL USUARIO

**WD43FC2380**

## TABLE OF CONTENTS

<b>1</b>	<b>Important Safety Instructions</b>	<b>2</b>
<b>2</b>	<b>Safety Information</b>	<b>3</b>
<b>3</b>	<b>Preparation</b>	What's Included <b>4</b>
		Front View <b>5</b>
		Rear View <b>6</b>
		Installing the Stand <b>7</b>
		Removing the Stand for Wall-Mounting <b>7</b>
	Remote Control <b>8</b>	
<b>4</b>	<b>Connecting External Devices</b>	<b>9</b>
<b>5</b>	<b>Customizing TV Settings</b>	Initial Setup <b>10</b>
		Navigating the Setup Settings <b>11</b>
		APPS <b>12</b>
		Media <b>13</b>
		Viewing JPEG <b>13</b>
		Viewing MJPEG <b>14</b>
		Source <b>14</b>
		Setup <b>15</b>
		Settings <b>15</b>
		Audio <b>16</b>
		Picture <b>17</b>
Channel <b>18</b>		
Time <b>18</b>		
Lock <b>19</b>		
Network <b>20</b>		
<b>6</b>	<b>Parental Control</b>	<b>22</b>
<b>7</b>	<b>Troubleshooting</b>	<b>24</b>
<b>8</b>	<b>Maintaining</b>	<b>25</b>
<b>9</b>	<b>Specification</b>	<b>26</b>
<b>10</b>	<b>OTT APP Service</b>	<b>27</b>

## IMPORTANT SAFETY INSTRUCTIONS

- **Read these instructions** – All the safety and operating instructions should be read before this product is operated.
- **Keep these instructions** – The safety and operating instructions should be retained for future reference.
- **Heed all warnings** – All warnings on the appliance and in the operating instructions should be adhered to.
- **Follow all instructions** – All operating and use instructions should be followed.
- **Do not use this apparatus near water** – The appliance should not be used near water or moisture – for example, in a wet basement or near a swimming pool, and the like.
- Clean only with dry cloth.
- **Do not** block any ventilation openings. Install in accordance with the manufacturer's instructions.
- **Do not** install near any heat sources such as radiators, heat registers, stoves, or other apparatus (including amplifiers) that produce heat.
- **Do not** defeat the safety purpose of the polarized or grounding-type plug. A polarized plug has two blades with one wider than the other. A grounding-type plug has two blades and a third grounding prong. The wide blade or the third prong are provided for your safety. If the provided plug does not fit into your outlet, consult an electrician for replacement of the obsolete outlet.
- Protect the power cord from being walked on or pinched particularly at plugs, convenience receptacles, and the point where they exit from the apparatus.
- Only use attachments/accessories specified by the manufacturer.
- Use only with the cart, stand, tripod, bracket, or table specified by the manufacturer, or sold with the apparatus. When a cart is used, use caution when moving the cart/apparatus combination to avoid injury from tip-over.
- Unplug this apparatus during lightning storms or when unused for long periods of time.



- Unplug this apparatus during lightning storms or when unused for long periods of time.
- Refer all servicing to qualified service personnel. Servicing is required when the apparatus has been damaged in any way, such as the power-supply cord or plug is damaged, liquid has been spilled or objects have fallen into the apparatus, the apparatus has been exposed to rain or moisture, does not operate normally, or has been dropped.
- Please keep the unit in a well-ventilated environment.

**WARNING:** To reduce the risk of fire or electric shock, do not expose this apparatus to rain or moisture. The apparatus should not be exposed to dripping or splashing. Objects filled with liquids, such as vases should not be placed on apparatus.

**WARNING:** The batteries shall not be exposed to excessive heat such as sunshine, fire or the like.

**WARNING:** The mains plug is used as disconnect device, the disconnect device shall remain readily operable.

**WARNING:** To reduce the risk of electric shock, do not remove cover (or back) as there are no user-serviceable parts inside. Refer servicing to qualified personnel.



This lightning flash with arrowhead symbol within an equilateral triangle is intended to alert the user to the presence of non-insulated "dangerous voltage" within the product's enclosure that may be of sufficient magnitude to constitute a risk of electric shock.



The exclamation point within an equilateral triangle is intended to alert the user to the presence of important operating and maintenance instructions in the literature accompanying the appliance.



This equipment is a Class II or double insulated electrical appliance. It has been designed in such a way that it does not require a safety connection to electrical earth.



This product contains electrical or electronic materials. The presence of these materials may, if not disposed of properly, have potential adverse effects on the environment and human health. Presence of this label on the product means it should not be disposed of as unsorted waste and must be collected separately. As a consumer, you are responsible for ensuring that this product is disposed of properly.



This product meets ENERGY STAR® guidelines for energy efficiency. ENERGY STAR and the ENERGY STAR mark are registered U.S. marks. ENERGY STAR is a registered mark owned by the U.S. government.

### Licensing and Patent Information

This WESTINGHOUSE product may be covered by one or more U.S. and foreign patents and patent applications.

## SAFETY INFORMATION

To ensure reliable and safe operation of this equipment, please carefully read all the instructions in this user guide, especially the safety information below.

### Electrical Safety

- The TV set should only be connected to a main power supply with voltage that matches the label at the rear of the product.
- To prevent overload, do not share the same power supply socket with too many other electronic components.
- Do not place any connecting wires where they may be stepped on or tripped over.
- Do not place heavy items on any connecting wire, which may damage the wire.
- Hold the main plug, not the wires, when removing from a socket.
- During a thunderstorm or when not in using the television for long periods, turn off the power switch on the back of the television.
- Do not allow water or moisture to enter the TV or power adapter. Do not use in wet, moist areas, such as bathrooms, steamy kitchens or near swimming pools.
- Pull the plug out immediately, and seek professional help if the main plug or cable is damaged, liquid is spilled onto the set, if the TV set accidentally exposed to water or moisture, if anything accidentally penetrates the ventilation slots or if the TV set does not work normally.
- Do not remove the safety covers. There are no user serviceable parts inside. Trying to service the unit yourself is dangerous and may invalidate the product's warranty. Qualified personnel must only service this apparatus.
- To avoid a battery leakage, remove batteries from the remote control, when the remote is not use for long period, or when the batteries are exhausted.
- Do not break open or throw exhausted batteries into a fire.

### Physical Safety

- Do not block ventilation slots in the back cover. You may place the TV in a cabinet, but ensure at least 5cm (2") clearance all around.
- Do not tap or shake the TV screen, or you may damage the internal circuits. Take good care of the remote control.
- To clean the TV use a soft dry cloth. Do not use solvents or petroleum based fluids.
- Do not install near any heat sources such as radiators, heat registers, stoves or other apparatus (including amplifiers) that produce heat.
- Do not defeat the safety purpose of the polarized or grounding-type plug. A polarized plug has two blades with one wider than the other. A grounding plug has two blades and a third grounding prong, the wide blade, or the third prong is provided for your safety. If the provided plug does not fit into your outlet, consult an electrician for replacement of the obsolete outlet.
- Protect the power cord from being walked on or pinched particularly at plugs.
- Unplug the apparatus during lightning storms or when unused for long periods.
- Refer all servicing to a qualified service personnel. Servicing is required if the apparatus does not operate normally or if the apparatus, including the power supply cord or plug, has been damaged in any way.
- Servicing is also required if liquid has been spilled, or objects have fallen into the apparatus; when the apparatus has been exposed to rain or moisture; or if the apparatus has been dropped.
- Always connect your television to a power outlet with protective ground connection.

## PREPARATION

### What's Included

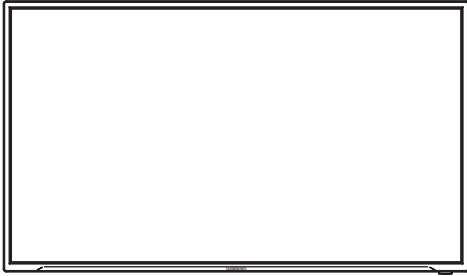

TV Set

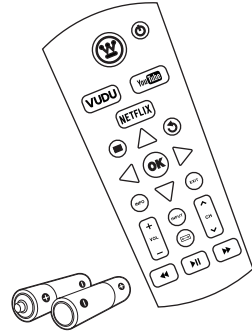

Remote Control with Batteries



TV Stand

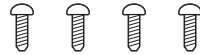

Four Screws

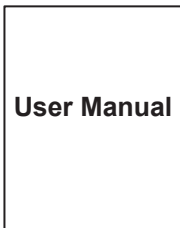

User Manual

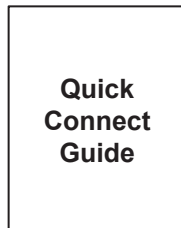

Quick Connect Guide

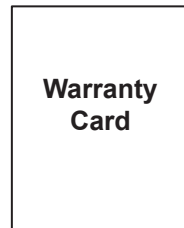

Warranty Card

## Front View

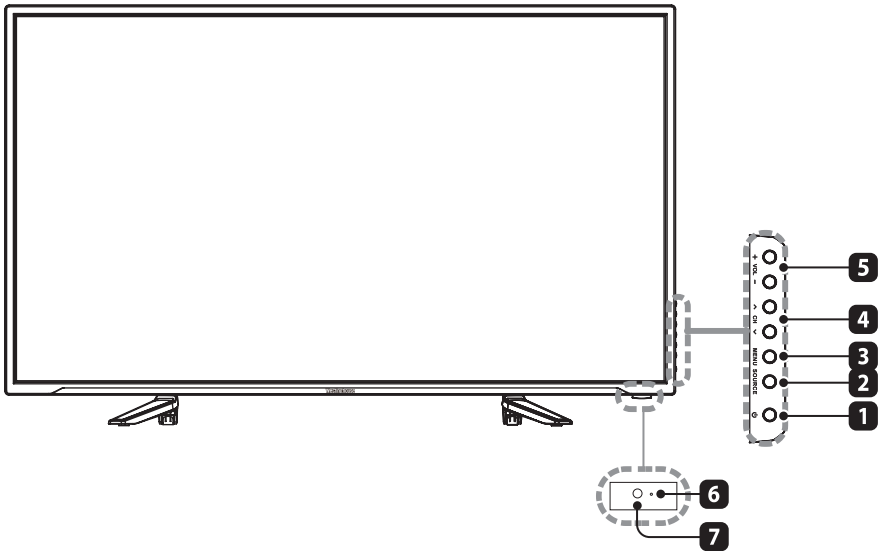

1. **POWER**  
Switch the TV between On / Standby mode.
2. **SOURCE**  
Press to select among different input signal sources.
3. **MENU**  
Display the main menu.
4. **CH**  $\nabla/\wedge$   
Press to select a channel.
5. **VOL**  $-/+$   
Press to adjust the volume.
6. **POWER Indicator**  
Illuminate blue when the TV is turned on. Illuminate red when the TV is in standby mode.
7. **IR** (Infrared Receiver)  
Receive IR signals from the remote control.

Rear View

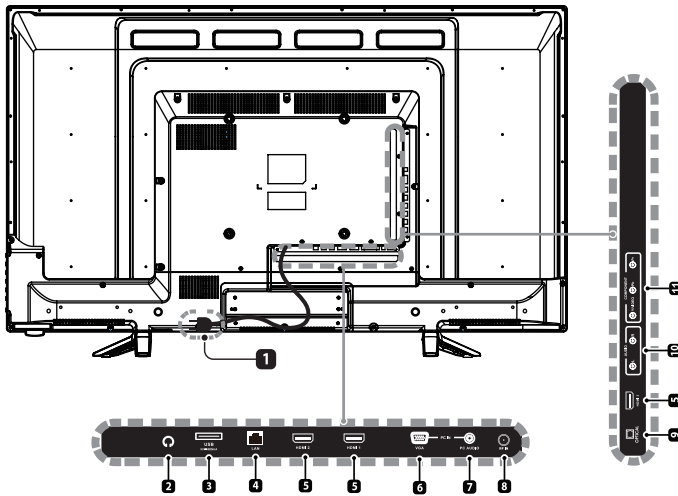

- 1. **Power Cord**  
Connect to AC power outlet.
- 2. **Headphone Socket**  
Connect to the Headphones.
- 3. **USB Port**  
Connect to a USB storage device to play compatible movie and photo files.
- 4. **LAN**  
Network connection port.
- 5. **HDMI Input**  
Connect to a High-Definition (HD) signal input device.
- 6. **VGA Input**  
Connect to a computer or other devices with a VGA interface.
- 7. **PC AUDIO Input**  
Connect to a computer audio output.
- 8. **DTV/TV Input**  
Connect to the antenna (75Ω VHF/UHF) socket with the RF coaxial cable.
- 9. **OPTICAL Output**  
Connect a digital sound system to this jack.
- 10. **AUDIO Input**  
Connect to the AUDIO (L/R) output sockets on external audio devices.
- 11. **COMPOSITE/COMPONENT IN**  
Connect to AV devices with composite/component (Y/Pb/Pr) video and audio output sockets. COMPOSITE VIDEO and COMPONENT(Y/PB/PR) share with AUDIO IN (L/R).

## Installing the Stand

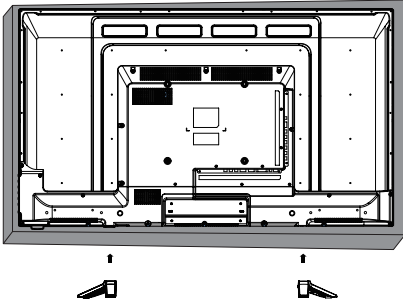

- 1. Lay the TV face down on a flat, cushioned surface to avoid damaging or scratching.
- 2. Fix the Left Base Stand to the main unit using 2 pcs provided screws.
- 3. Fix the Right Base Stand to the main unit using 2 pcs provided screws.

## Removing the Stand for Wall-Mounting

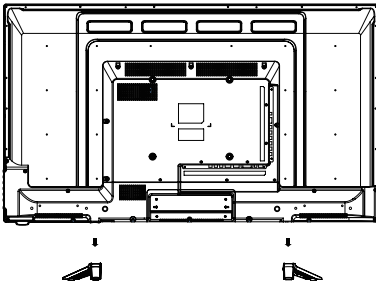

- 1. Lay the TV face down on a flat, cushioned surface to avoid damaging or scratching.
- 2. Untighten the 4 pcs screws holding the stand assembly and remove them.
- 3. Attach the wall-mount bracket to the TV using the mounting holes on the back of the TV. Mount this TV according to the instructions included in the wall-mount bracket.

**WARNING:** This apparatus is intended to be supported by UL Listed wall mount bracket.



Remote Control

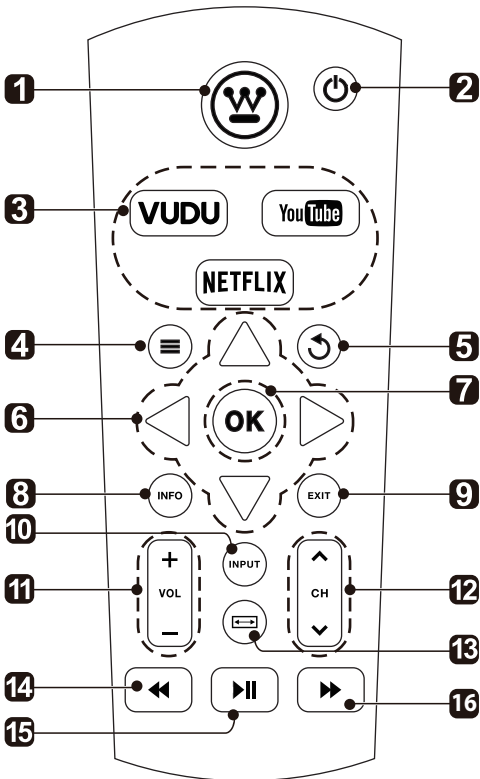

1. **HOME**: Display the Home menu.
2. **POWER**: Turn the LED TV on or off.
3. **APPS**: Press to select the desired APPS.
4. **≡**: Display the main TV menu.
5. **↻**: Return to previous menu button.
6. **◀▶**: Allows you to navigate the OSD menus and adjust the system settings to your preference.
7. **OK**: Confirm the selection in the OSD (on screen display).
8. **INFO**: Displays the current input source and the channel information.
9. **EXIT**: Exit the main TV menu.
10. **INPUT**: Select among the different input signal sources: TV/AV/YPBPR/HDMI1/ HDMI2/HDMI3/VGA.
11. **VOL +/-**: Press to increase/ decrease the sound level.
12. **CH ^/∇**: Press to scan through channels.
13. **⊞**: Press to select Aspect Ratio.
14. **⏮**: Reverse playback rapidly.
15. **⏪**: Start playback or pause.
16. **⏭**: Advance playback rapidly.

# CONNECTING EXTERNAL DEVICES

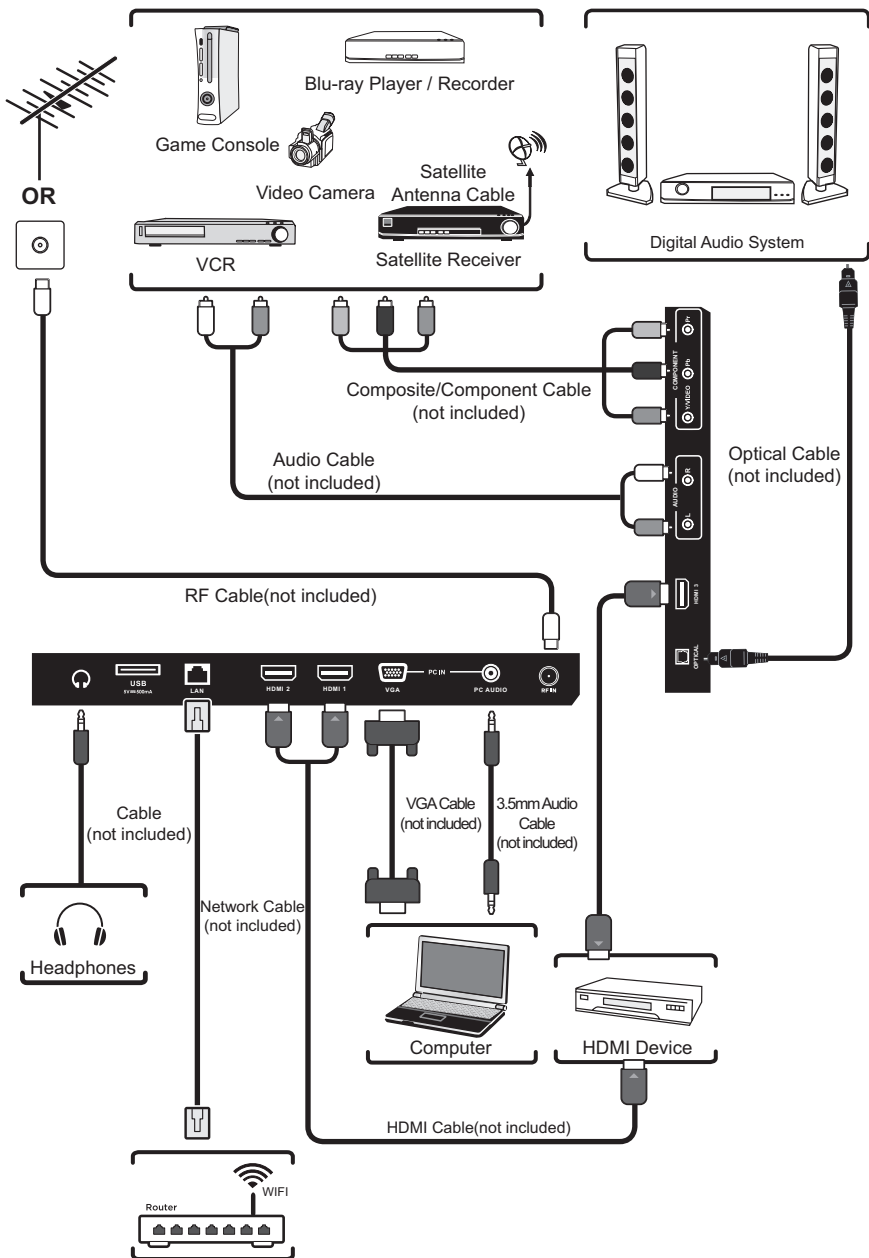

# CUSTOMIZING TV SETTINGS

## Initial Setup

- Connect the power cord to the power socket after you have completed all the physical connections. At this stage, the TV will enter Standby Mode and the red LED indicator will illuminate.
- In Standby Mode, press the **U** button on the main unit or on the remote control to turn the TV on. The red LED indicator will turn blue.
- The first time you turn the TV on, it will go into the Setup Wizard. Press **▲/▼** buttons to select your desired mode and press **OK** to confirm.

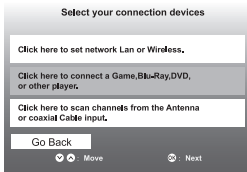
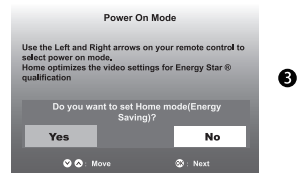
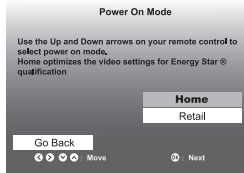
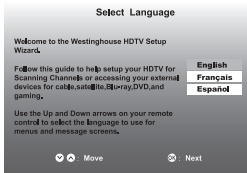

**Home Mode (Energy Saving)** is the default as-shipped television configuration and settings. And **Home Mode (Energy Saving)** is the setting in which the product qualifies for **ENERGY STAR®**. Any changes to default as-shipped television configuration and settings would change the energy consumption. And enabling certain optional features and functionalities may increase energy consumption beyond the limits required for **ENERGY STAR®** qualification, as applicable.

**Retail Mode** : Select Retail Mode if you would like your picture to be brighter. At times this mode may use more energy to operate the Volume/Sound Mode and the Picture Mode. In this setting, the power consumption may possibly exceed the limited requirement of the **ENERGY STAR®** qualification.

**ENERGY STAR®** is a set of power-saving guidelines issued by the U.S. Environmental Protection Agency (EPA).

**ENERGY STAR®** is a joint program of the U.S. Environmental Protection Agency and the U.S. Department of Energy helping us all save money and protect the environment through energy efficient products and practices.

- **The ON-MODE Power under Home Mode should be less than 67 W**
- **The SLEEP-MODE Power should be less than 0.5 W.**

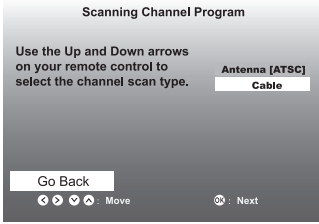

6

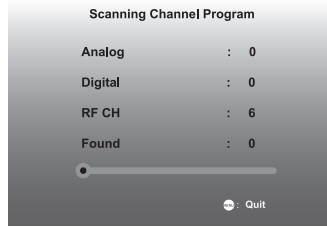

7

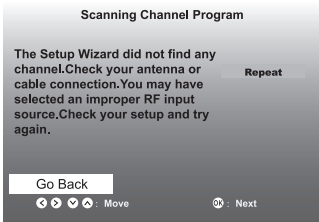

8

- If channels can not be found, this frame will be displayed automatically.

## Navigating the Setup Settings

- Press the **MENU** button to display the main menu.
- Use **◀/▶** buttons to select **setup** menu and then press **OK** buttons to enter, then press **◀/▶** to navigate and select the available menu.

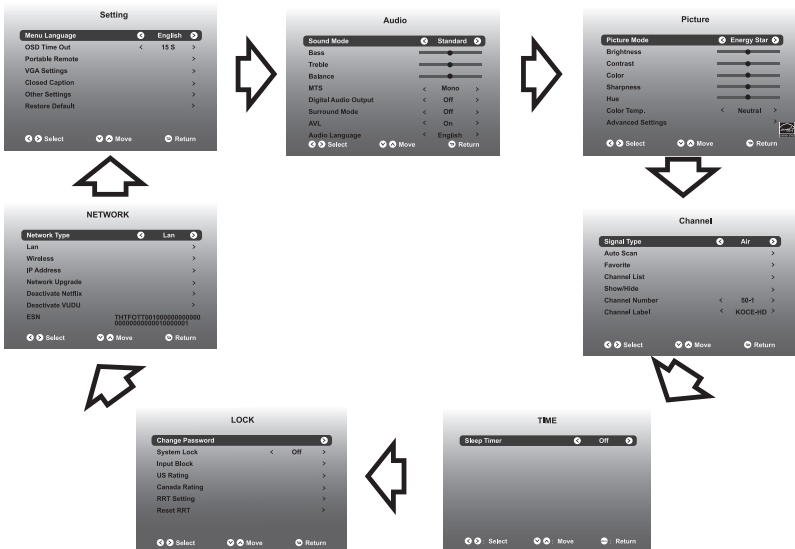

**APPS**

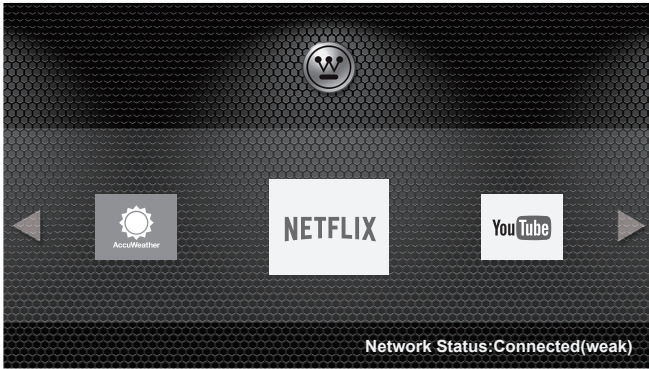

- Press the **MENU** button on the main unit or on the remote control to display the main menu. Then use ◀/▶ to select the **apps** and press **OK** button to enter. Use ◀/▶ to select the desired app. Or press the hotkey on the remote control to enter the APP directly.

*Note: After the TV connects to network, the status Unconnected will alter to Connected.*

<b>NETFLIX</b>	Enjoys TV shows & movies streamed instantly over the Internet.
<b>YouTube</b>	YouTube your way on the best screen in your house.
<b>VUDU</b>	Discover, watch and collect the latest movies and TV shows in high quality 1080p. Free to sign up. No subscriptions, late fees or commitments.
<b>Toongoggles</b>	A subscription video on-demand platform that offers animated, fun and educational cartoons, engaging games and songs from all over the world and in many different languages to children.
<b>Pandora</b>	Free personalized radio that offers effortless and endless music enjoyment and discovery. Just start with the name of one of your favorite artists, songs, genres or composers and Pandora will do the rest. It's easy to create personalized stations that play only music you'll love.
<b>AccuWeather</b>	Displays the current weather conditions and the temperature anywhere in the world in centigrade or Fahrenheit.

**MEDIA**

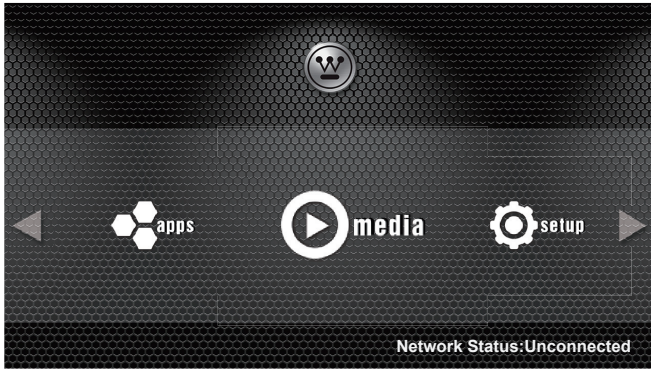

**NOTE:** Portable storage devices( USB disk or Hard disk) should be inserted.

- Press the **MENU** button on the main unit or on the remote control to display the main menu. Then use **◀/▶** to select the **media** and press **OK** button to enter. Use **◀/▶** to select the desired option.

**■ Viewing JPEG**

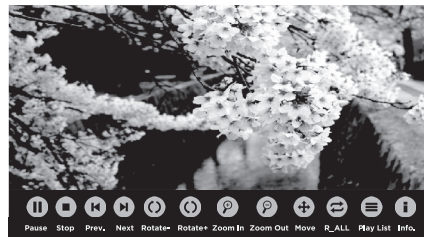
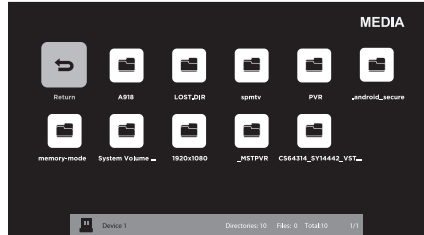
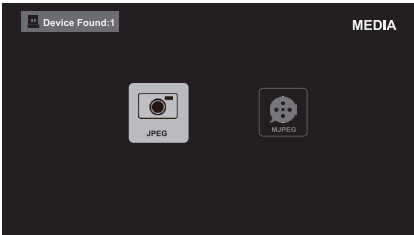

- After entering **MEDIA**, press **◀/▶** buttons to select **JPEG** and then select the disk type to enter. Then use **▲/▼/◀/▶** buttons to navigate in the picture folder and then select the desired picture and press **OK** button, when **✓** appears on the top-left, press **▶||** to play the picture, or press **menu** button to display the control bar, then use **◀/▶** to select **Play** to display the picture.

■ Viewing MJPEG

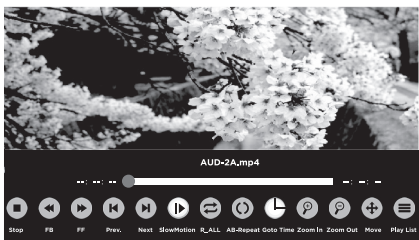
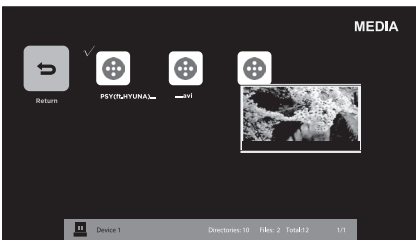
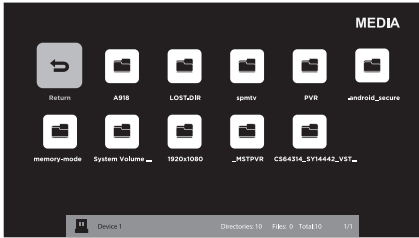
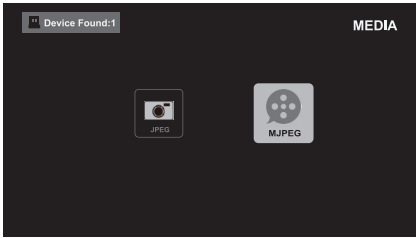

- After entering **MEDIA**, press ◀/▶ buttons to select **MJPEG** and then select the disk type to enter. Then use ▲/▼ / ◀/▶ buttons to navigate in the video folder and then select the desired video and press **OK** button, when ✓ appears on the top-left, press ▶▶ to play the video, or press **menu** button to display the control bar, then use ◀/▶ to select **Play** to display the video.

■ SOURCE

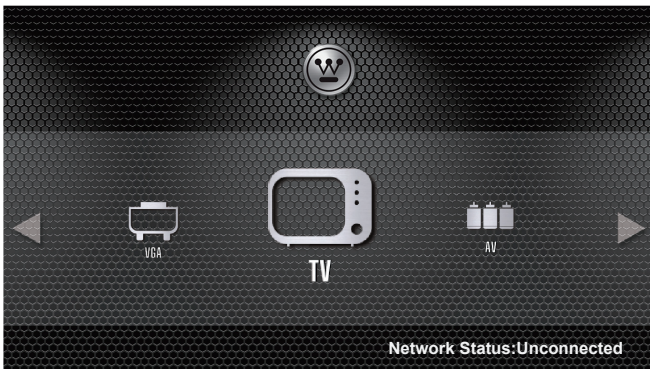

- Press the **menu** button on the main unit or on the remote control to display the main menu. Then use ◀/▶ to select the **source** and press **OK** button to enter. Use ◀/▶ to select the desired input sources among: **TV/ AV/ YPBPR/ HDMI1/ HDMI2/ HDMI3/ VGA** and press **OK** button to confirm.

**SETUP**

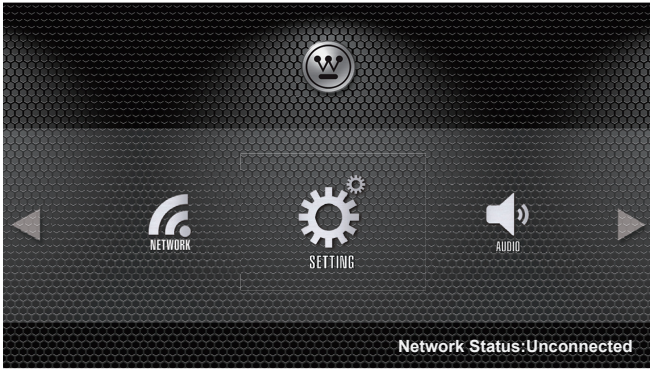

- Press the **menu** button on the main unit or on the remote control to display the main menu. Then use **◀/▶** to select the **setup** and press **OK** button to enter. Use **◀/▶** to select the desired option.

**SETTING**

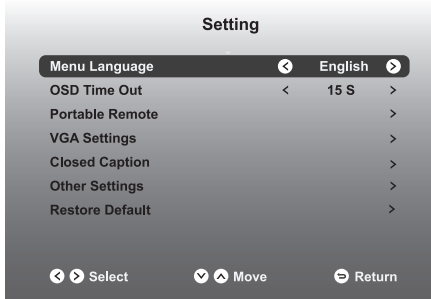

- Press **◀/▶** buttons to select **SETTING** menu and then press **OK** button to enter. Press **▲/▼** buttons to select the following setting options and then press **◀/▶** buttons to adjust each option's setting.

<b>Menu Language</b>	Select menu language : English, Français or Español. The default on-screen menu language is English.
<b>OSD Time Out</b>	Select OSD time among 15s/30s/45s/60s.
<b>Portable Remote</b>	Firstly, use your portable device to scan the QR code to download the APP ( <i>Make sure the portable device and the TV in the same network</i> ), or you may also type in "Westinghouse Remote" in Google Play or APP store to download the APP. Secondly, enter the 6 digits code after app installation. 6 digits code: N/A ( <i>You can find the 6 digits code under the QR code</i> ).
<b>VGA Settings</b>	To adjust the VGA settings: H-Pos, V-Pos, Clock, Phase, Auto.



<b>Closed Caption</b>	CC Mode	Select CC mode :CC On, CC Off or CC On Mute.
	Analog CC	Basic Selection: CC1, CC2, CC3, CC4, Text1, Text2, Text3, Text4.
	Digital CC	Advanced Selection: Service1, Service2, Service3, Service4, Service5, and Service6.
	Option	Mode, Font Style, Font Size, Font Edge Style, Font Edge Color, FG Color, BG Color, FG Opacity, BG Opacity.
<b>Other Settings</b>	Turn On or Off the Audio Only.	
<b>Restore Default</b>	Restore the TV to factory default settings.	

■ AUDIO

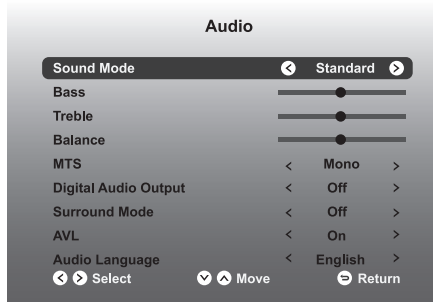

- Press ◀/▶ buttons to select **AUDIO** menu and then press **OK** button to enter. Press ▲/▼ buttons to select the following audio options and then press ◀/▶ buttons to adjust each option's setting.

<b>Sound Mode</b>	Allow the selection of an audio-enhancement technique: Standard/Music/Movie/Sports/User.
<b>Bass</b>	Control the relative intensity of lower-pitched sounds. (For User mode)
<b>Treble</b>	Control the relative intensity of higher-pitched sounds. (For User mode)
<b>Balance</b>	Adjust the relative volume of the speaker in a multiple speaker system.
<b>MTS</b>	Press button ▲/▼ to select MTS, then press button ◀/▶ to adjust.
<b>Digital Audio Output</b>	Select the digital audio output mode between RAW/PCM/Off.
<b>Surround Mode</b>	Turn On or Off the surround mode.
<b>AVL</b>	Volume levels are automatically controlled to On or Off.
<b>Audio Language</b>	Select audio language among: English, Français or Español.

PICTURE

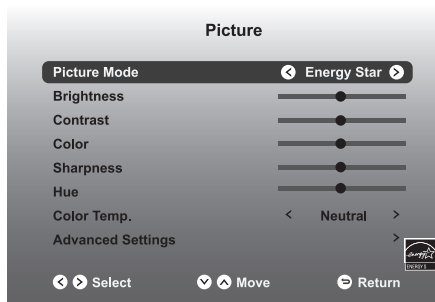

- Press ◀/▶ buttons to select **PICTURE** menu and then press **OK** button to enter. Press ▲/▼ buttons to select the following picture options and then press ◀/▶ buttons to adjust each option's setting.

<b>Picture Mode</b>	Cycle among picture mode: Energy Star/User/Retail/Movie.
<b>Brightness</b>	Increase or decrease the amount of white in the picture. <i>(For User mode)</i>
<b>Contrast</b>	Adjust the difference between light and dark levels in the pictures. <i>(For User mode)</i>
<b>Color</b>	Control the color intensity. <i>(For User mode)</i>
<b>Sharpness</b>	Adjust the level of crispness in the edges between light and dark areas of the picture. <i>(For User mode)</i>
<b>Hue</b>	Adjust the hue intensity.
<b>Color Temp.</b>	Cycle among color temperatures: Neutral/Warm/User/Cool.
<b>Advanced Settings</b>	Select and adjust the following settings. <b>1) Aspect Ratio:</b> Choose to view the TV picture in various formats among: Standard/Fill. <b>2) Noise Reduction:</b> Reduces the noise level of the connected device: Off/Weak/Medium/Strong. <b>3) Dynamic Contrast:</b> Set dynamic contrast to On/Off. <b>4) White Balance:</b> To adjust the white balance.

■ CHANNEL

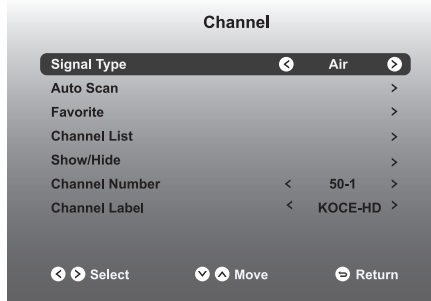

- Press ◀/▶ buttons to select **CHANNEL** menu and then press **OK** button to enter. Press ▲/▼ buttons to select the following channel options and then press ◀/▶ buttons to adjust each option's setting.

<b>Signal Type</b>	Select antenna between Air and Cable.
<b>Auto Scan</b>	Cable: Select your cable system from: Auto/STD/IRC/HRC. Auto Scan: Select the Auto Scan feature to scan your available cable channels.
<b>Favorite</b>	Set the selected channel as favorite channels.
<b>Channel List</b>	Display the current channel list.
<b>Show/Hide</b>	Show/Hide the selected channel.
<b>Channel Number</b>	Display the current channel number.
<b>Channel Label</b>	Display the current channel label.

■ TIME

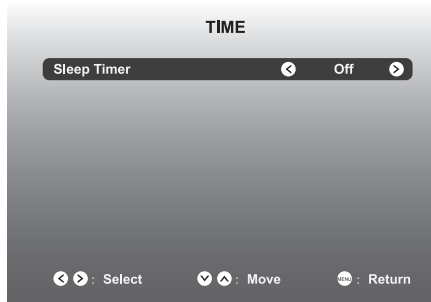

- Press ◀/▶ buttons to select **TIME** menu and then press **OK** button to enter. Press ▲/▼ buttons to select the following time options and then press ◀/▶ buttons to adjust each option's setting.

<b>Sleep Timer</b>	Select a period of time after which the TV automatically switches to standby mode: Off/5/10/.../180/240 min.
--------------------	--

■ LOCK

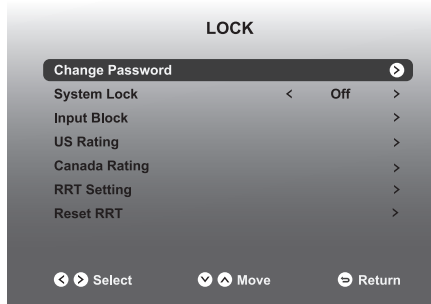

- Press ◀/▶ buttons to select **LOCK** menu and then press **OK** button to enter. Use the 0-9 buttons to input 4-digit password to enter the **LOCK** menu.
- Press ▲/▼ buttons to select the following lock options and then press ◀/▶ buttons to adjust each option's setting.

**Note:** the default password is "0000".

<b>Change Password</b>	Use <b>0-9</b> buttons to input the new 4-digit password and re-enter to confirm the new password.	
<b>System Lock</b>	Select to turn On/Off system lock. The following options (US, Canada, Reset RRT) will only be accessible when you turn the system lock on.	
<b>Input Block</b>	To block or unblock the different input sources.	
<b>US Rating</b>	TV	TV RATING: Press <b>OK</b> button to lock or unlock TV rating.
	MPAA	Select MPAA rating : N/A,G, PG, PG-13, R, NC-17,or X.
<b>Canada Rating</b>	Canada English	Select MPAA rating for English-speaking Canada : E, C, C8+, G, PG, 14+, 18+.
	Canada French	Select MPAA rating for Quebec Canada : E, G, 8 ans+, 13 ans+, 16 ans+, 18 ans+.
<b>RRT Setting</b>	Set Rating Region Table.	
<b>Reset RRT</b>	Select to reset the RRT setting.	

**■ NETWORK**

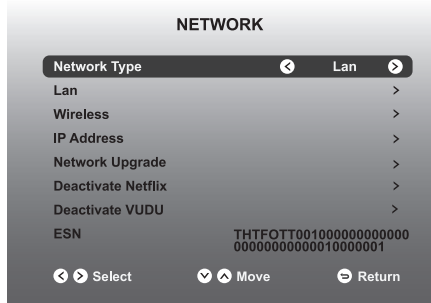

- Press ◀/▶ buttons to select **NETWORK** menu and then press **OK** button to enter. Press ▲/▼ buttons to select the following network options and then press ◀/▶ buttons to adjust each option's setting.

<b>Network Type</b>	Select two types of network: Wireless or Lan.
<b>Lan</b>	Connect the TV to the wired Lan: Auto Get IP/Manual Get IP.
<b>Wireless</b>	Connect the TV to the wireless network through searching the available Wifi.
<b>IP Address</b>	Display the current IP information.
<b>Network Upgrade</b>	Upgrade the TV software through the network.
<b>Deactivate Netflix</b>	Deactivate Netflix and clear the account information.
<b>Deactivate Vudu</b>	Deactivate Vudu and clear the account information.
<b>ESN</b>	Electronic Serial Number

**Auto Upgrade**

- After the TV connects to network, the system will automatically detect software version.

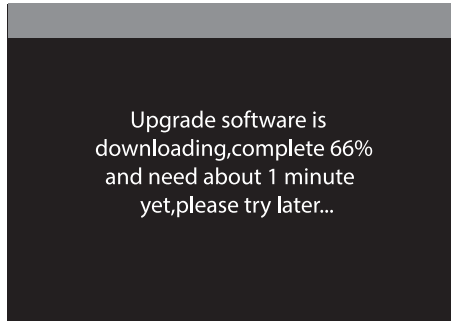

- If there is a new version, it will be downloaded in the background. When you want to enter the app, a menu bar will pop up reminding you that upgrade software is downloading. Please try later...

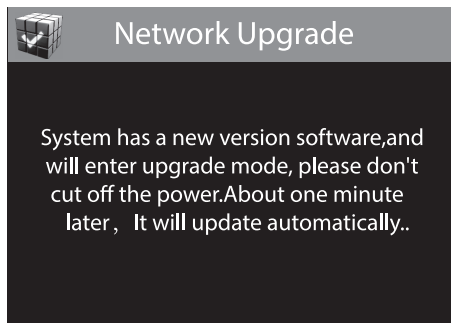

- After the download completed, it can upgrade automatically after users press the standby button.

**Note:** This procedure is fully automatic, and remember not to cut off the power.

### Manual Upgrade

- After the TV connects to network, users can detect whether there is a new version through network manual option.

### Reminder for internet connection:

- Below occasions are possible while your internet is connected to enjoy your OTT services.
- 1. Please check your internet signal strength while internet is connected, signal strength below 50 may result bad connection and non-smooth picture.
- 2. To enter OTT services, 30 second may be required for internet connection.

### Recommended 10Mb above internet speed

---

## PARENTAL CONTROL

Press the **MENU** button on the main unit or on the remote control and then press ◀/▶ buttons to select **LOCK** menu. Use the **0-9** buttons to input the 4-digit password to enter the **LOCK** menu. If used, this option feature can "block" undesirable programming from appearing on the TV. Parental Control offers the user a wide variety of options and settings that restrict or "block" the programming that can appear on the TV. Parental Control allows the user to define which program rating they consider acceptable for younger more sensitive viewer. It can be preset and turned either on or off by the user who specifies the secret 4-number code, the password. The number of hours blocked are specified. General audiences and children blocks should be both programmed into the TV's memory. Separate different viewer ratings are specified for both TV and the motion picture Industry; both rating systems should be used and based on the ages of children.

### Overview

To ensure complete coverage for all TV programs, (movies and regular TV shows) choose a rating for MPAA, from the selections below, as well as ratings from the TV Parental Guidelines Rating Systems below, using the Age Block option for General Audiences, and for children. In addition, you may wish to add additional restrictions from the content block menu, and submenu examples below.

### Things to Consider before Setting up Parental Control

Determine which rating you consider acceptable to the viewer. (For example, if you choose TV-PG, more restrictive ratings will be automatically blocked; the viewer will not be able to see: TV-PG, TV-14, or TV-MA rated programming.) You may block the auxiliary video source entirely. (Blocks the signal sent by the equipment, such as VCR, connected to the TV Audio/Video Input Jacks) or remain unblocked, then choose acceptable ratings. Block program "Content" based on individual parameters such as: Strong Dialog, Bad Language, Sex Scenes, Violence Scenes or Fantasy. Violent Scenes; in Content Blk option. Select a secret password, in the Set Password option, using the numbers keys on the remote control. Save the password, it is the only way to access the Parental Control menu and change rating setting, or turn off Parental Control.

- You can set different Parental Control viewing restrictions for general audiences and for children, both can be active at the same time.
- Simply specifying one content block such as Sex Scenes, will not automatically restrict the programming that appears from the video sources.
- Even If you choose to leave the AUX Inputs unblocked, the ratings you specify will automatically restrict the programming that appears from the video sources.
- You cannot disable Parental Control by disconnecting the TV from power. Block hours will be automatically reset to the original block time setting specified if power is disconnected.

## PARENTAL CONTROL

### • Motion Picture Association of America (MPAA) Rating System

	Grade	Meaning
<b>G</b>	General Audiences	Content not offensive to most viewers.
<b>PG</b>	Parental Guidance Suggested	Content is such that parents may not want their children to view the program.
<b>PG-13</b>	Parents Strongly Cautioned	Program is inappropriate for preteens, with a greater degree of offensive material suggested than a PG rated program.
<b>R</b>	Restricted	Not for children under 17-contains strong element of sex and/or violence.
<b>NC-17</b>	No children under age 17	Not for children under 17-under any circumstances. Contains strong sexual content.
<b>X</b>	Hard Core Films	Same as NC-17 rating.
<b>No Rating</b>	No Rating	MPAA did not rate

### • TV Parental Guideline Rating System

	Grade	Meaning
<b>TV-Y</b>	All Children	Content not offensive to most viewers.
<b>TV-Y7</b>	Directed to Older Children	Considered suitable for children over 7- may contain fantasy violence scenes.
<b>TV-G</b>	General Audience	Considered suitable for all audience; children may watch unattended.
<b>TV-PG</b>	Parental Guidance Suggested	Suggested unsuitable for younger children-may contain suggestive language, bad language, sex and violence scenes.
<b>TV-14</b>	Parents Strongly Cautioned	unsuitable for children under 14 - may contain strong language, bad language, sex, and violence scenes.
<b>TV-MA</b>	Mature Audience Only	Adults only- may contain strong language, bad language, sex, and violence scenes.

#### Canadian Rating:

Canadian English is used throughout all English-speaking Canada (C, C8+, G, PG, 14+, 18+).

Canadian French is used in Quebec (G, 8 ans+, 13 ans+, 16 ans+, 18 ans+)

**Note:** The V-Chip will automatically block certain categories that are "more restrictive". If you block TV-Y category, then TV-Y7 will be automatically blocked. Similarly, if you block TV-G category, then all the categories in the "young adult" will be blocked (TV-G, TV-PG, TV-14, and TV-MA).



## TROUBLESHOOTING

If your TV does not operate normally or cannot be turned on, please check the following troubleshooting questions. Remember also to check any other connected electronic device, such as DVD or Blu-ray player to pinpoint the problem. If the TV still fails to operate normally, please contact technical support.

### The TV does not operate properly

The TV does not respond when pressing any buttons	<ul style="list-style-type: none"> <li>The TV may freeze up during use. Disconnect the power cord from the power socket for a few minutes. Reconnect the power cord and try to operate it again as usual.</li> </ul>
TV cannot be switched on	<ul style="list-style-type: none"> <li>Check that the TV is connected to the power supply.</li> <li>Make sure all connected AV devices are switched off before switching on your TV.</li> </ul>
The remote control does not work	<ul style="list-style-type: none"> <li>Check to see if there are any objects between the TV and the remote control causing an obstruction. Ensure that you are pointing the remote control directly at the TV.</li> <li>Ensure that the batteries are installed with the correct polarity (+ to +, - to -).</li> <li>Install new batteries.</li> </ul>
Power is suddenly turned off	<ul style="list-style-type: none"> <li>Check the power of the TV. The power supply maybe interrupted.</li> <li>Check if the sleep timer is set.</li> <li>Check whether the Auto Standby is activated.</li> </ul>

### The video function does not work

No picture & No Sound	<ul style="list-style-type: none"> <li>Check whether the TV is switched on.</li> <li>Try another channel. The problem may be caused by the broadcaster.</li> </ul>
Picture appears slowly after switching on	<ul style="list-style-type: none"> <li>This is normal; the image is muted during the TV startup process. Please contact your service centre if the picture has not appeared after five minutes.</li> </ul>
No or poor color or poor picture	<ul style="list-style-type: none"> <li>Adjust the settings in the PICTURE menu.</li> <li>Try another channel. The problem may be caused by the broadcaster.</li> <li>Check if video cables are connected properly.</li> </ul>
Horizontal/Vertical bar or picture shaking	<ul style="list-style-type: none"> <li>Check for local interference such as an electrical appliance or power tool.</li> </ul>
Poor reception on some channels	<ul style="list-style-type: none"> <li>The station or cable channel may be experiencing problems; tune to another station.</li> <li>Station signal may be weak, reposition the antenna for better reception.</li> <li>Check for sources of possible interference.</li> </ul>
Lines or streaks in pictures	<ul style="list-style-type: none"> <li>Check antenna (change the position of the antenna.)</li> </ul>
No pictures when connecting HDMI	<ul style="list-style-type: none"> <li>Check if the input source is HDMI1/HDMI2/HDMI3.</li> </ul>
Pictures appear in wrong ratio	<ul style="list-style-type: none"> <li>Adjust the Aspect Ratio settings in the SETUP menu or press the ASPECT button on the remote control.</li> </ul>

## TROUBLESHOOTING

The audio function does not work	
Picture OK but no sound	<ul style="list-style-type: none"><li>• Press the VOL +/- buttons.</li><li>• Sound muted? Press the MUTE button.</li><li>• Try another channel. The problem may be caused by the broadcaster.</li></ul>
No output from one of the speakers	<ul style="list-style-type: none"><li>• Adjust the Balance settings in the AUDIO menu.</li></ul>
Unusual sound from inside the TV	<ul style="list-style-type: none"><li>• A change in ambient humidity or temperature may result in an unusual noise when the TV is switched on or off and does not indicate a fault with the TV.</li></ul>
No sound when connecting HDMI	<ul style="list-style-type: none"><li>• Check if the input source is HDMI1/HDMI2/HDMI3.</li></ul>
Audio noise	<ul style="list-style-type: none"><li>• Keep the RF coaxial cable away from the other connected cables.</li></ul>
Password	
Lost password	<ul style="list-style-type: none"><li>• Select the SET Password setting in the LOCK menu, then enter the following master password "8899". The master password clears your previous password and allows you to enter a new password.</li></ul>
There is a problem in PC mode	
The signal is out of range (invalid format)	<ul style="list-style-type: none"><li>• Adjust the resolution, horizontal frequency, or vertical frequency.</li></ul>
Vertical bar or stripe on background & Horizontal Noise & Incorrect position	<ul style="list-style-type: none"><li>• Use Auto configures or adjust clock, phase, or H/V position.</li></ul>
Screen color is unstable or show a single color	<ul style="list-style-type: none"><li>• Check the signal cable.</li><li>• Reinstall the PC video card.</li></ul>

## Maintaining

- Do not use your TV in areas that are too hot or too cold, because the cabinet may warp or the screen may malfunction. Your TV works best in temperatures that are comfortable to you.
- Storage temperatures are 32° to 122°F(0° to 50°C)
- Working temperatures are 32° to 95°F(0° to 35°C)
- Do not place your TV in direct sunlight or near a heat source

## SPECIFICATION

Panel Size	42.5 inch diagonally
Display Type	DLED
Panel Technology	TFT
Panel 60 Hz Vs. 120 Hz	60 Hz
Display Resolution	1080P
HDMI Support	Up to 1080P
Panel Resolution	1920 x 1080
Aspect Ratio	16:9
Dynamic Contrast Ratio-Panel	2400~3000:1
Response Time (G To G)	6.5 ms
Lamp Life (Typ. Hours)	30,000 hours
Horizontal Viewing Angle (At CR>10)	178
Vertical Viewing Angle (At CR>10)	178
Wall-mount(LxW-mm)	200*200 VESA(mm)

The FCC Wants You to Know



### FCC STATEMENT

This device complies with Part 15 of the FCC Rules. Operation is subject to the following two conditions:

- (1) This device may not cause harmful interference, and
- (2) This device must accept any interference received, including interference that may cause undesired operation.

Changes or modifications not expressly approved by the party responsible for compliance could void the user's authority to operate the equipment.

NOTE: This equipment has been tested and found to comply with the limits for a Class B digital device, pursuant to Part 15 of the FCC Rules. These limits are designed to provide reasonable protection against harmful interference in a residential installation.

This equipment generates uses and can radiate radio frequency energy and, if not installed and used in accordance with the instructions, may cause harmful interference to radio communications. However, there is no guarantee that interference will not occur in a particular installation. If this equipment does cause harmful interference to radio or television reception, which can be determined by turning the equipment off and on, the user is encouraged to try to correct the interference by one or more of the following measures:

Reorient or relocate the receiving antenna.

Increase the separation between the equipment and receiver.

Connect the equipment into an outlet on a circuit different from that to which the receiver is connected.

Consult the dealer or an experienced radio/TV technician for help.

### FCC Radiation Exposure Statement

This equipment complies with FCC radiation exposure limits set forth for an uncontrolled environment. This equipment should be installed and operated with minimum distance 20cm between the radiator & your body.

## OTT APP SERVICE

If you want to know about these APP information or get more service. Please refer to following content.

- **Netflix**



You can call the following telephone for more help: **866-579-7172**

If your matter is regarding customer service, please refer to <https://contactus.netflix.com/help> for alternative contact information.

- **YouTube**



You can browse the following website for more help:

<https://productforums.google.com/forum/#!categories/youtube/smart-tvs>

- **VUDU**



You can call the following telephone for more help: **888-554-8838**

- **TG**



You can call the following telephone for more help: **888-874-5411**

- **Pandora**



You can send E-mail to Pandora for more help: [pandora-support@pandora.com](mailto:pandora-support@pandora.com)

- **AccuWeather**



You can send E-mail to AccuWeather for more help: [CustomerService@AccuWeather.com](mailto:CustomerService@AccuWeather.com)



[www.westinghouseelectronics.com](http://www.westinghouseelectronics.com)



S/N: \_\_\_\_\_



Westinghouse Electronics, LLC  
Diamond Bar, CA

SE-UM-4301-1501

## Free Manuals Download Website

<http://myh66.com>

<http://usermanuals.us>

<http://www.somanuals.com>

<http://www.4manuals.cc>

<http://www.manual-lib.com>

<http://www.404manual.com>

<http://www.luxmanual.com>

<http://aubethermostatmanual.com>

Golf course search by state

<http://golfingnear.com>

Email search by domain

<http://emailbydomain.com>

Auto manuals search

<http://auto.somanuals.com>

TV manuals search

<http://tv.somanuals.com>