

# SoundPlus® Infrared System • Model WIR SYS 90 PRO



## Description:

The TX90 two channel IR transmitter combines modulator and emitter technology into a single operating unit, which reduces operating cost and eliminates precious rack space. The TX90 transmitter produces a wide-angle infrared signal that concentrates the IR energy efficiently in the listening area. Operating on the 2.3-3.8 MHz bandwidth, the TX90 is less susceptible to radio and lighting interference. Each TX90 transmitter can cover up to 28,000 sq ft (2,600 sq m) in single-channel operation. The coverage area can be easily increased by connecting additional TX9 emitters. A wall/ceiling omnidirectional mount is included, and stand kits are available for portable operation.

## Applications:

**Cinemas • Simultaneous Interpretation • Audio Description • Conferences • Multi-Media Rooms  
Boardrooms • Courtrooms • Schools • Universities • Churches**

## WIR TX90 Transmitter:

Dimensions, Weight:	11.25" W x 6.25" H x 2.125" D (28.6 cm x 15.9 cm x 5.4 cm), 1.8 lbs (0.8 kg)
Color:	Black with white legends, black acrylic lens
Power Supply:	Wall Transformer, 24 VAC, 50-60 Hz, 35 VA, 3-pin MOLEX Connector North America: TFP 010, UL/CSA Europe: TFP 027-01, 2-pin Schuko plug, CE UK: TFP 027-02, 3-pin UK plug, CE
Power Cable:	NEC Class 2 wiring, two-conductor, 18 ga., 200' (61m) max. length
Modulation:	FM Wideband, +50kHz deviation max., 50uS pre-emphasis
Carrier Frequency:	Channel A: Selectable, 2.3/2.8 MHz, Channel B: Selectable, 3.3/3.8 MHz
Emitter IR Power:	3.5 watts
Coverage Area:	28,000 ft <sup>2</sup> (2,600 m <sup>2</sup> ) in single-channel mode when using the RX22-4 Receiver 18,000 ft <sup>2</sup> (1,670 m <sup>2</sup> ) in four-channel mode when using the RX22-4 Receiver 3,500 ft <sup>2</sup> (325 m <sup>2</sup> ) in single-channel mode when using the RX14-2 Receiver 3,063 ft <sup>2</sup> (285 m <sup>2</sup> ) in single-channel mode when using the RX16 Receiver (See coverage area diagrams)
Signal-to-Noise Ratio:	>75 dB, +3dB
Frequency Response:	80 to 15,000 Hz, electrical response
Total Harmonic Distortion:	Less than .2%, electrical response at 1kHz
Compression:	Music preset 1:1, Voice preset 1.5:1, Hearing Assist preset 2:1
Auto Carrier Shut-Off:	20 minute timer shuts off carrier when no audio is present

**Fig. 1: TX90 Bottom View:**

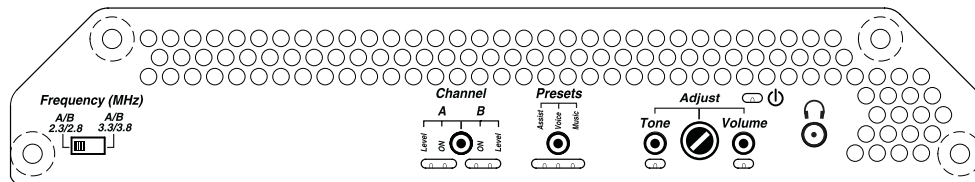

Power Indicator:	Red LED
Audio Volume Level Controls:	CHA and CHB Input Level, press to select, 28 dB adjustable range
Audio Indicators:	CHA and CHB Audio Level, yellow LED, flash
Carrier LEDs:	2 green LED carrier "on" indicators
Phones Output:	3.5mm TRS headphone jack. CH A tip, CH B ring on jack, 32 ohm headphone (min)
Application Preset:	Music, Voice, Hearing Assist. Frequency response; Music: Flat; Voice: Mid-range boost; Hearing Assist: High frequency boost
Tone Control:	Press to select, 21 dB adjustable range (1 kHz between low boost/hi-cut and low cut/hi boost).

**NOTE: SPECIFICATIONS SUBJECT TO CHANGE WITHOUT NOTICE!**

\* 90 days on accessories.

# SoundPlus® Infrared System • Model WIR SYS 90 PRO



Fig 2: TX90 Rear View

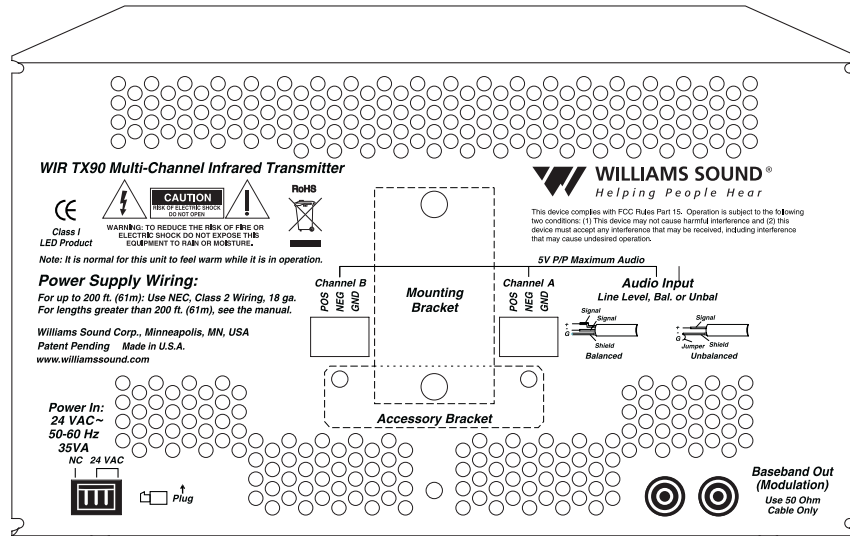

Power Input:	3-Pin Molex, 24 VAC, 50-60 Hz, 35 VA
Audio Input Connector:	CHA and CHB, 3 wire Phoenix
Input Level:	Balanced or unbalanced, 316 mVRMS (-10dBV) nominal, 5.7k input impedance; max input (over volume range) -21 to +7 dBV.
Baseband Output:	BNC, 50 Ω, for use with TX9 only
Baseband Cable:	RG 58 Coax, BNC connectors, maximum 1000' (300m) length
Operating Requirements:	0-50° C (+32°F to 122°F) ambient temperature, non-condensing, non-corrosive atmosphere
Mounting Kits:	Wall or Ceiling Mount: BKT 024 Omnidirectional mount; Optional: Tripod Stands: SS-11 or SS-6
Warranty:	5 years on transmitter, 90 days on accessories
Approvals:	CE, FCC, RoHS, WEEE
Compatible Receivers:	WIR RX22-4 Four-Channel Receiver, WIR RX14-2 Two-Channel Receiver, WIR RX16 Two-Channel Receiver
Notes:	Specifications: Single end input, volume & tone controls at mid point, 1 kHz, "Music" Preset

**NOTE: SPECIFICATIONS SUBJECT TO CHANGE WITHOUT NOTICE!**

# SoundPlus® Infrared System • Model WIR SYS 90 PRO



Fig. 3: Receiver Coverage Area with TX90 Transmitter in Single Channel Mode

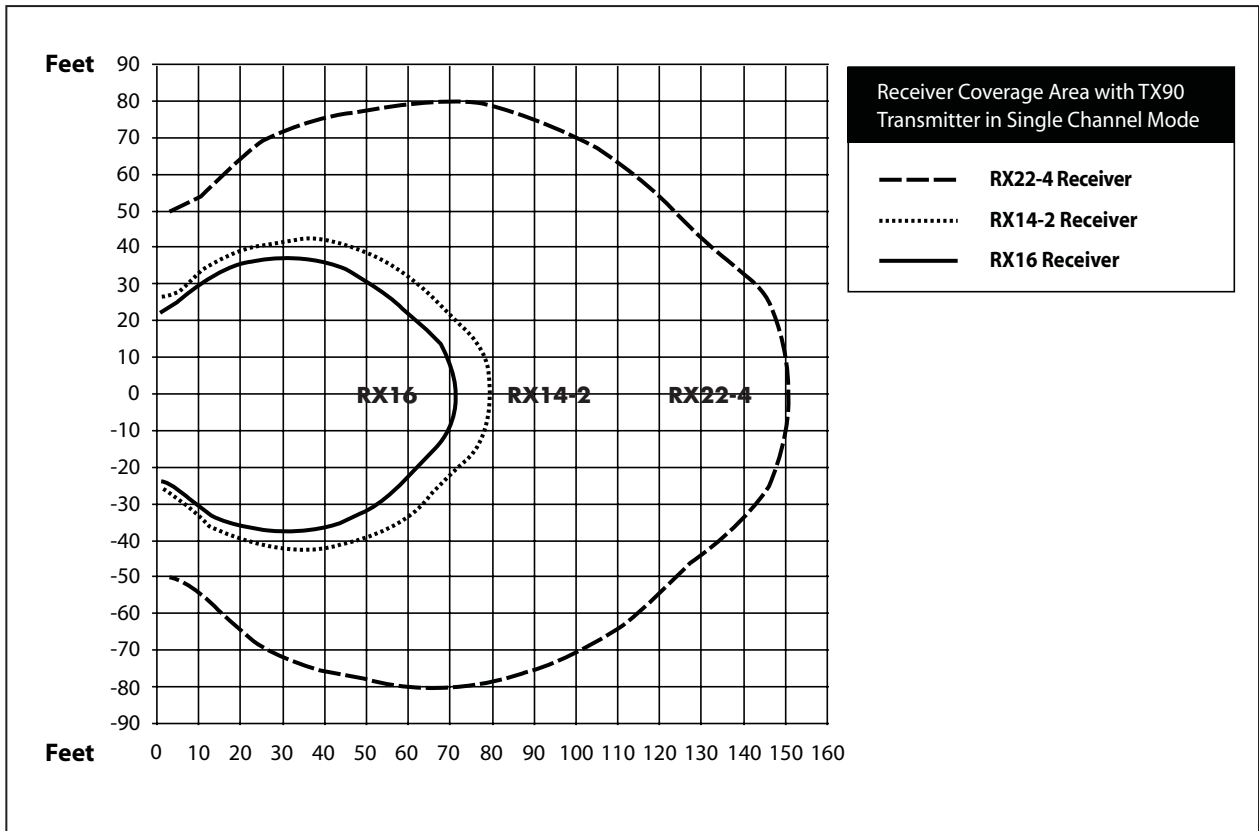

The coverage area for the TX90 will vary depending on the receiver being used. The diagram above demonstrates the receiver coverage when operating a single TX90 transmitter in single channel mode. Patterns are direct radiation patterns.

Note: Reflections of the infrared light from walls, ceilings and floors may change these patterns.

**NOTE: SPECIFICATIONS SUBJECT TO CHANGE WITHOUT NOTICE!**

# SoundPlus® Infrared System • Model WIR SYS 90 PRO



SoundPlus® Infrared System • Model WIR SYS 90 PRO

**Fig. 4: 3-Dimension Foot Pattern**

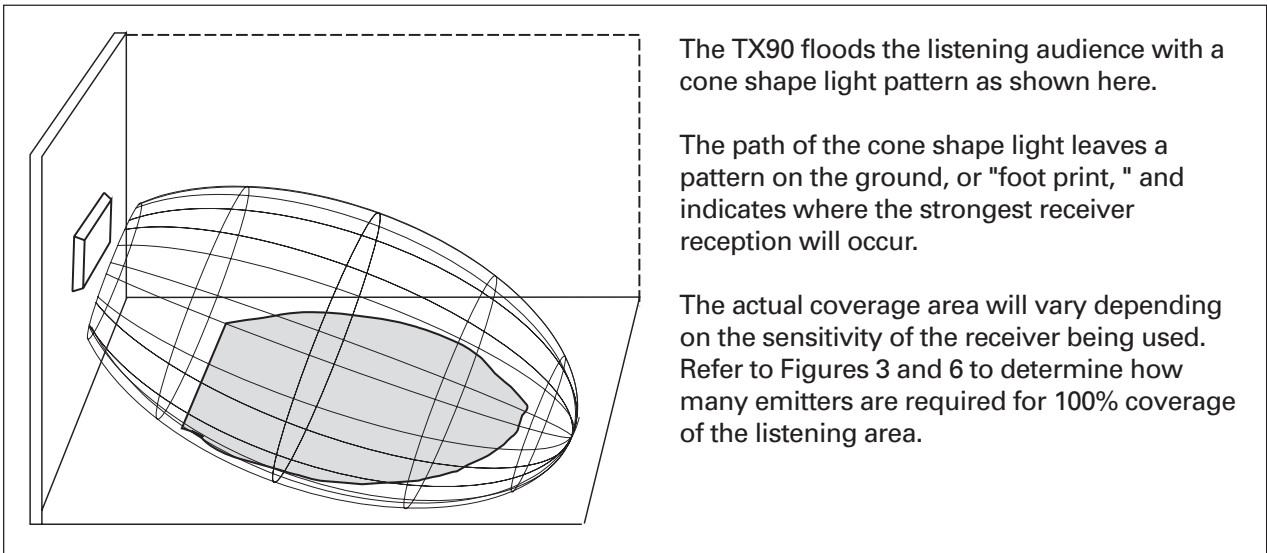

To determine the best location for the transmitter, it helps to think of the IR transmitter as an invisible floodlight. You'll want to aim it so the listeners are "flooded" with the infrared light. The transmitter should also be positioned high enough so it won't be blocked by people and other physical obstructions. See Figure 5 below. Mount the transmitter at least 2 ft. (.61 m) above the audience. Position the transmitter to face in a slightly downward angle, 20°, that will increase the "throw" of the infrared beam.

**Fig. 5: Vertical Beam Spread**

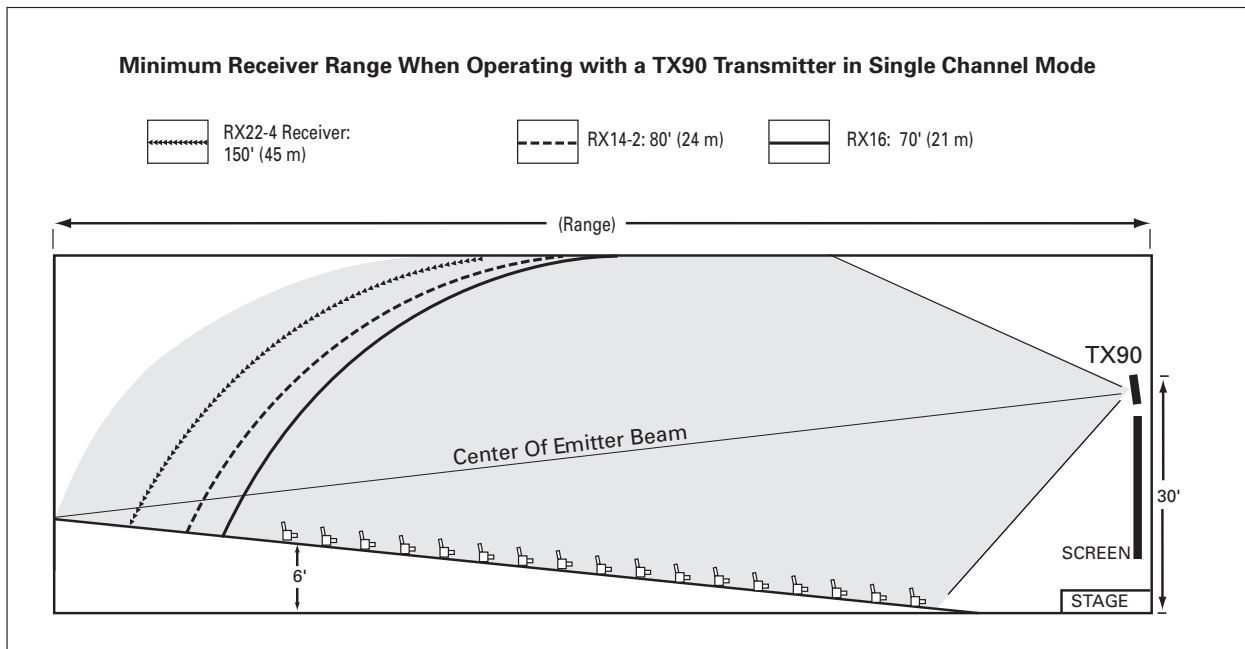

**NOTE: SPECIFICATIONS SUBJECT TO CHANGE WITHOUT NOTICE!**



## Maximum Range When Using the RX22-4 Infrared Receiver

Fig. 6: Horizontal and Vertical Radiation Polar Plots

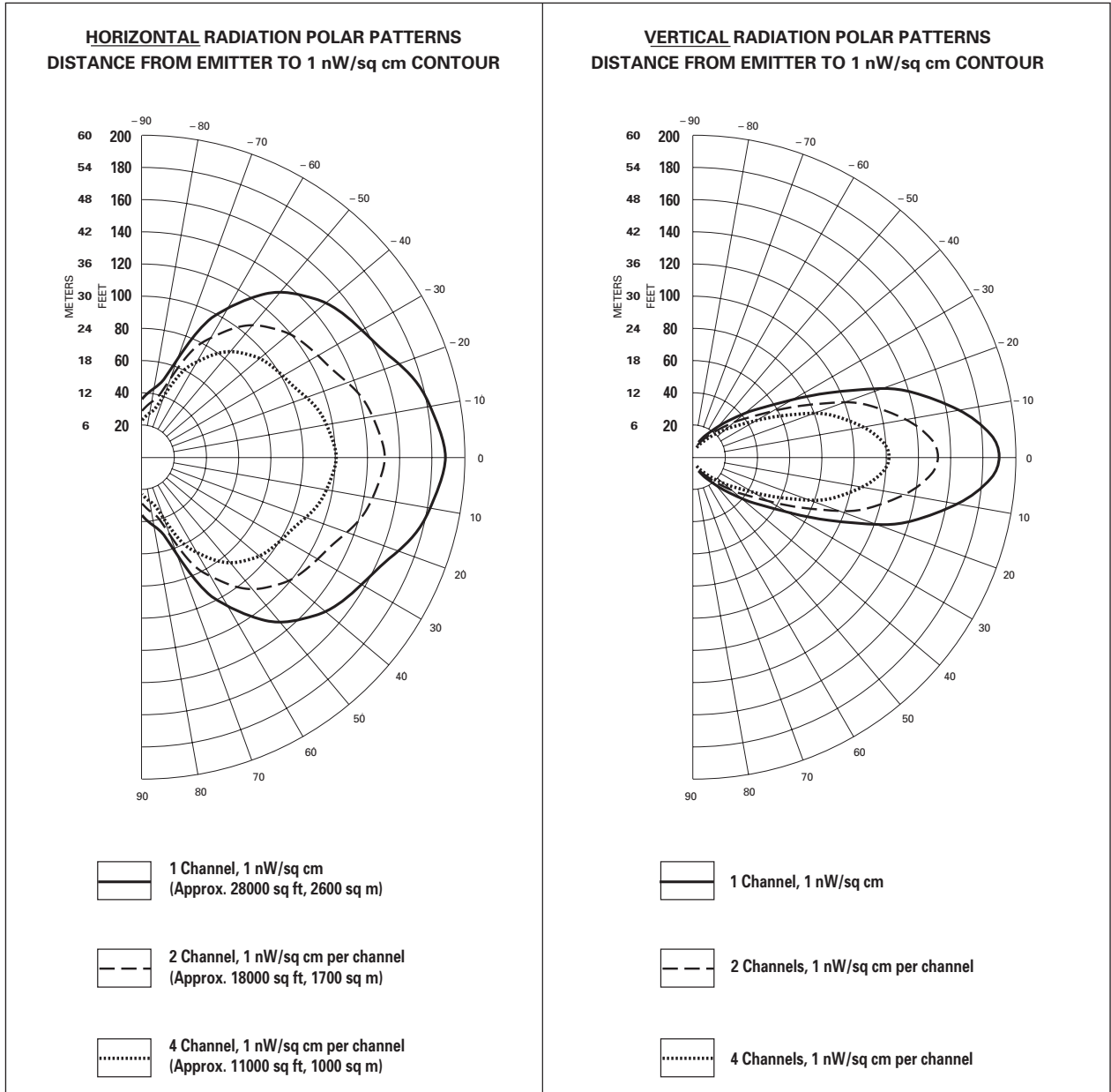

Reflections of the infrared light from walls, ceilings, and floors may change these patterns. Important: Remember to point the emitter towards the listening audience!

If you're not getting sufficient coverage with a single, properly installed TX90 Transmitter, you may need to add additional WIR TX90 Transmitters to achieve full coverage of your listening area. Figures 7a and 7b illustrate how multiple emitters can be used for large room installations.

**NOTE: SPECIFICATIONS SUBJECT TO CHANGE WITHOUT NOTICE!**

# SoundPlus® Infrared System • Model WIR SYS 90 PRO



## Multiple Emitters Installed to Maximize Coverage

Fig. 7a: Overlapping Illumination Patterns to Cover Larger Listening Areas

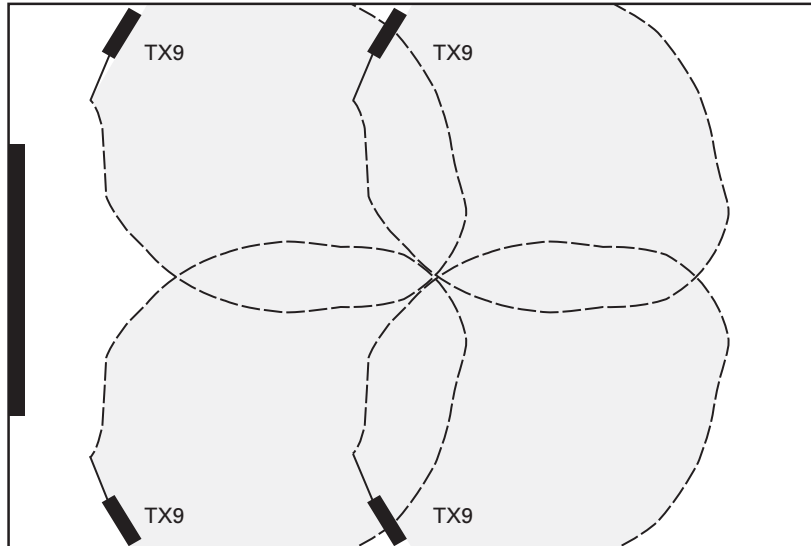
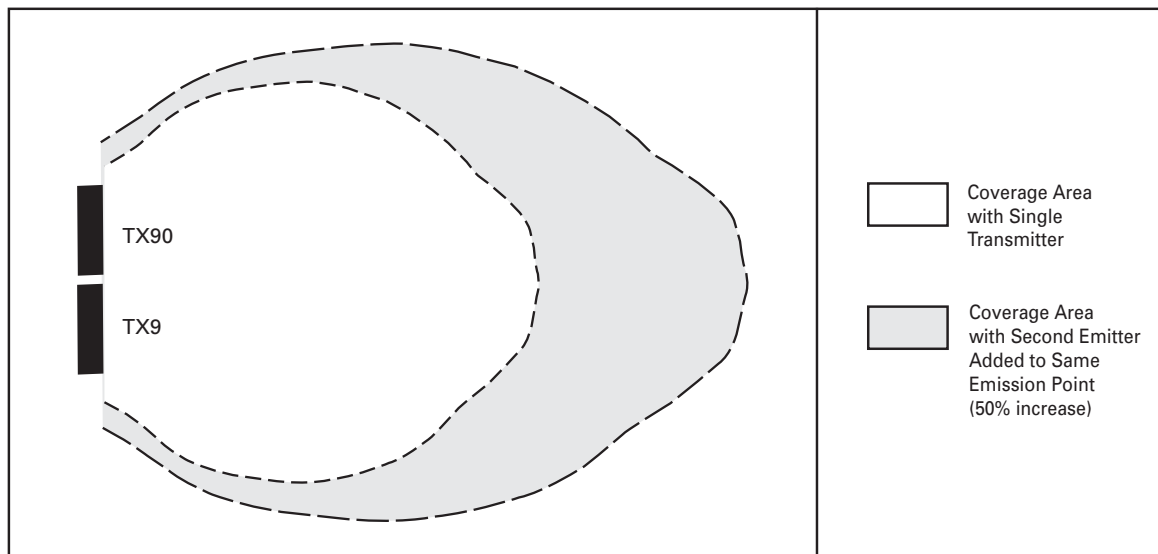

Fig. 7a above is a typical example of how multiple emitters are used to cover larger listening areas. Generally it is desirable for the illumination patterns to overlap. Note: The coverage area will vary depending on the infrared receiver being used; refer to Figures 3 and 6 to determine how many emitters are required to achieve full coverage of a listening area.

Fig. 7b: Overlapping Illumination Patterns to Cover Larger Listening Areas



When a TX90 transmitter and TX9 emitter are used at the same emission point in single channel mode, the overall coverage area increases 50%. When using an RX22-4 receiver, as a result, the coverage area will increase to an estimated 42,000 ft<sup>2</sup> (3,902 m<sup>2</sup>); the RX14-2 will increase to 5,250 ft<sup>2</sup> (488 m<sup>2</sup>); the RX16 will increase to 4,590 ft<sup>2</sup> (426 m<sup>2</sup>).

**NOTE: SPECIFICATIONS SUBJECT TO CHANGE WITHOUT NOTICE!**

# SoundPlus® Infrared System • Model WIR SYS 90 PRO



## WIR RX16 Receiver:

Weight:	2.1 oz (60 g) with batteries
Material and Color:	ABS plastic, Black and Grey
Battery Type, Life:	BAT AP97A NiMH Battery Pack, 6 hours
Operating Range:	3,063 ft <sup>2</sup> (285 m <sup>2</sup> ) when used with the TX9 emitter or TX90 transmitter in single-channel mode
Modulation Frequency:	2.3 MHz or 2.8 MHz or stereo
Frequency Response:	200 Hz to 8 kHz, $\pm$ 5 dB
Signal to Noise Ratio:	58 dB at 10 m
Controls:	Volume control thumbwheel 3-position selection switch (2.3 MHz, 2.8 MHz, stereo)
Acoustic Output:	112 dB MAX SSPL90 with 2 cc coupler
Compatibility:	Compatible with 2.3 MHz and 2.8 MHz IR transmitters, WIR TX900 and WIR TX925 systems
Power Switch:	Built into receiver "arms"
Ear pads:	Uses EAR 031 foam cushions
Approvals:	CE, RoHS
Warranty:	5 years (90 days on battery)

Fig. 8: WIR RX16 Front View

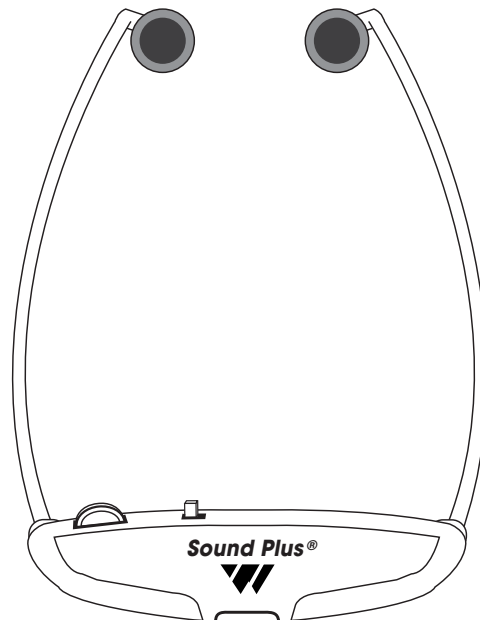

**NOTE: SPECIFICATIONS SUBJECT TO CHANGE WITHOUT NOTICE!**

# SoundPlus® Infrared System • Model WIR SYS 90 PRO



SoundPlus® Infrared System • Model WIR SYS 90 PRO

## CHG 516 Multiple Unit Charger

Dimensions:	12"L x 6.25"W x 1.5"H (30.48 cm x 15.875 cm x 3.81 cm)
Weight:	1.04 lbs (.47 kg) excluding power supply
Color:	Black metal and plastic
Power Supply Input:	120 VAC
Power Supply:	TFP 024 12 VDC - 200 mA
Unit Capacity:	5 Units
Indicators:	Individual Charging Indicators: Red LEDs
Warranty:	1 year (90 day warranty on cables and power supply)
Approvals:	WEEE
Note:	Charging specifications are based on Williams Sound Corp. rechargeable NiMH battery, BAT AP97A

Fig. 9: CHG 516

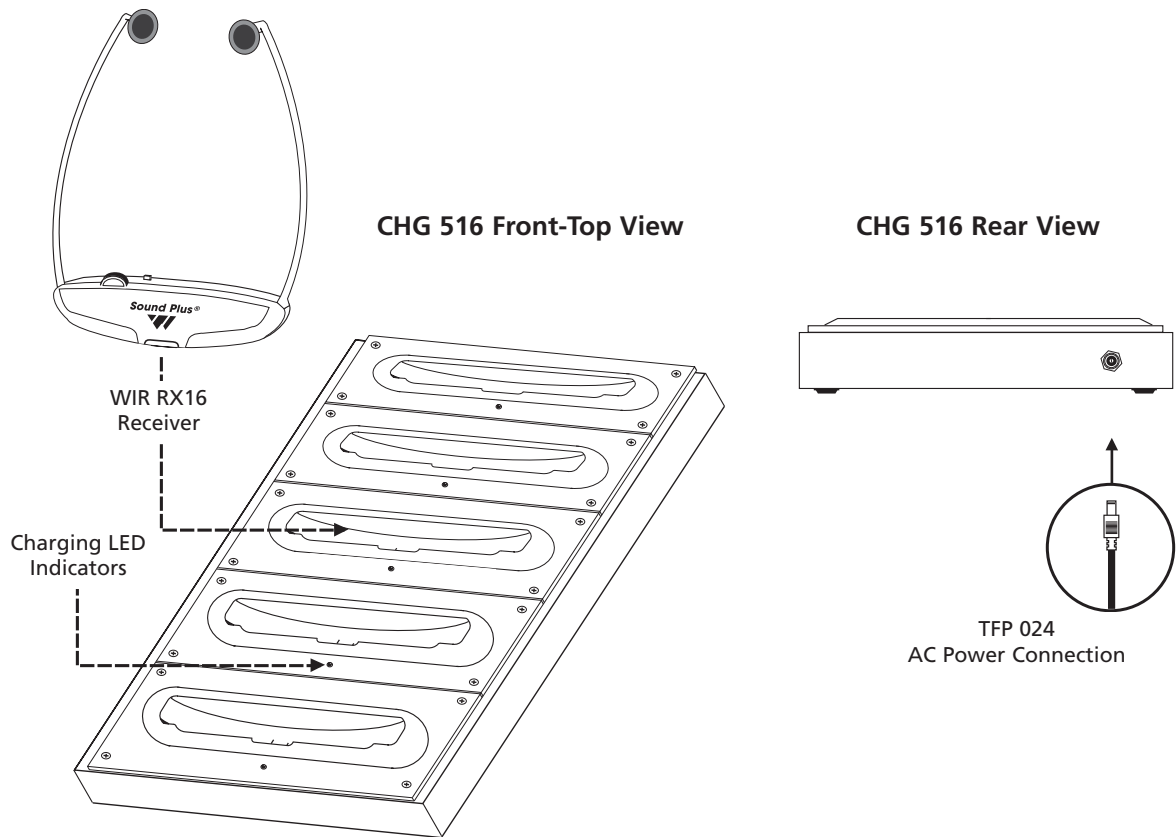

**NOTE: SPECIFICATIONS SUBJECT TO CHANGE WITHOUT NOTICE!**



# SoundPlus® Infrared System • Model WIR SYS 90 PRO



## Bid Specs

### WIR TX90 Transmitter

The Williams Sound Corp. WIR TX90 transmitter shall consist of an all-in-one modulator and emitter operating on switchable carrier frequencies of 2.3/2.8 MHz or 3.3/3.8 MHz. The carrier frequency shall use 50 kHz deviation and 50µs pre-emphasis.

The transmitter shall have a range of 28,000 ft<sup>2</sup> (2,600 m<sup>2</sup>) in single channel mode when using the RX22-4 receiver. The transmitter shall be contained in a metal housing with a durable plastic lens. The transmitter shall be convection cooled without fans. The transmitter shall include an omni-directional mounting bracket for permanent installations. Additional brackets shall be available for different mounting options.

The transmitter shall provide two channels of selectable carrier frequencies: CH A 2.3/2.8 MHz or CH B 3.3/3.8 MHz. Two transmitters used in tandem shall provide up 4 simultaneous channels.

The transmitter shall have two Phoenix connectors on the back for balanced or unbalanced line input. All controls and indicators shall be accessible on the bottom of the panel of the transmitter.

The transmitter shall have three application presets: Music, Hearing Assistance and Voice accessible by thumbscrew adjuster.

There shall be a 3.5mm stereo headphone jack for monitoring the processed audio before being transmitted.

Two BNC (50Ω) baseband output jacks shall be provided on the back panel for more coverage needs. The TX9 emitter panels must be used with the TX90 transmitter via RG58 coax cable.

The transmitter shall be powered by an external 24VAC, 50-60 Hz, 35VA power supply. The power connector shall be a three pin Molex type. Additional emitters shall require individual external power supplies.

The transmitter shall be covered by a five-year warranty on parts and labor. The transmitter shall be the Williams Sound Corp. model WIR TX90

### WIR RX16 Receiver

The receiver shall be a stetho type with an IR detector lens on the face of the unit. The receiver shall have a rotary-type volume control and the power switch shall be built into the "arms," so that the unit will automatically shut off when not in use. The receiver shall operate for 6 hours per charge with 1 BAT AP97A NiMH battery. The receiver shall be housed in a grey and black ABS plastic case. The receiver shall have a 3-position switch to receive 2.3 MHz, 2.8 MHz or stereo modulated IR signals. The receiver shall provide 112 dB SSPL90 output. The system electrical frequency response shall be 200 Hz to 8 kHz, and the signal-to-noise ratio shall be 60 dB at 10 m. The receiver shall have CE, RoHS, and WEEE approval. The receiver shall be covered by a five-year parts and labor warranty, 90 days on the battery.

The receiver shall be the Williams Sound Corp. model WIR RX16.

### CHG 516 Charger

The CHG 516 shall be a 5 unit drop-in battery charger and shall charge a maximum of 5 BAT AP97A NiMH batteries while they are installed into the Williams Sound Corp. WIR RX16 style 3V receivers.

The charger shall be enclosed in metal and plastic measuring 12"L x 6.25"W x 1.5"H (30.48 cm x 15.875 cm x 3.81 cm). The unit shall weigh 1.04 lbs (.47 kg) without power supply, 1.6 lbs (.725 kg) shipping weight.

Each bay on the charger shall have a red LED indicating charging status. The LEDs shall be on constantly during charging. Receivers can be left in the charger permanently without harm to the batteries.

The charger CHG 516 shall be powered by an external power supply (120 VAC input; 12 VDC, 200 mA output) via a CD barrel connector.

The charger shall be the Williams Sound Corp. model CHG 516.

**NOTE: SPECIFICATIONS SUBJECT TO CHANGE WITHOUT NOTICE!**

# SoundPlus® Infrared System • Model WIR SYS 90 PRO



## Contact:

### United States

Williams Sound Corp.  
10321 W. 70th Street  
Eden Prairie, MN 55344  
Phone: 800-328-6190 or 952-943-2252  
Fax: 952-943-2174  
Web: [www.williamssound.com](http://www.williamssound.com)  
Email: [info@williamssound.com](mailto:info@williamssound.com)

### Canada

Thorvin Electronics  
2861 Sherwood Heights Dr. Units 36-37  
Oakville, ON L6J-7K1 Canada  
Phone: 800-323-6634 or 905-829-3040  
Fax: 905-829-4196  
Web: [www.thorvinelectronics.com](http://www.thorvinelectronics.com)

### United Kingdom

Sound Associates  
Keeble House, 81 Island Farm Road  
West Molesey, Surrey KT 2SA  
United Kingdom  
Phone: (44) 020 8939 5900  
Fax: (44) 020 8939 5901  
Web: [www.soundassociates.co.uk](http://www.soundassociates.co.uk)  
Email: [jmurdoch@soundassociates.com](mailto:jmurdoch@soundassociates.com)

### Asia, Australia, Europe, Latin America, South America, South Africa

International Sales Department  
Williams Sound Corp.  
10321 W. 70th Street  
Eden Prairie, MN 55344 USA  
Phone: +1 952 224 7791  
Fax: +1 952 943 2174  
Email: [info@williamssound.com](mailto:info@williamssound.com)  
Web: [www.williamssound.com](http://www.williamssound.com)

**NOTE: SPECIFICATIONS SUBJECT TO CHANGE WITHOUT NOTICE!**

## Free Manuals Download Website

<http://myh66.com>

<http://usermanuals.us>

<http://www.somanuals.com>

<http://www.4manuals.cc>

<http://www.manual-lib.com>

<http://www.404manual.com>

<http://www.luxmanual.com>

<http://aubethermostatmanual.com>

Golf course search by state

<http://golfingnear.com>

Email search by domain

<http://emailbydomain.com>

Auto manuals search

<http://auto.somanuals.com>

TV manuals search

<http://tv.somanuals.com>