

HOW TO PROVIDE LIGHTNING PROTECTION FOR TV ANTENNA AND SET

Step 1. Mount the lightning arrestor or 75 ohm coaxial grounding block as close as possible to where the 75 ohm coaxial cable downlead enters the house. See Figure 6.

Step 2. The ground wires for both the mast and the downlead should be copper or aluminum wire, number eight (8) or larger. See Figure 6.

Step 3. The downlead wire from the antenna to the lightning arrestor and the mast ground wire should be secured to the house with stand-off insulators, spaced four (4) to six (6) feet apart. See Figure 6.

NOTE: In the case of a "ground up" antenna installation, it may not be necessary to ground the mast if the mast extends four or more feet into the earth. Consult a TV serviceman for the proper depth in your location.

Fig. 6

Example of antenna grounding as per National Electrical Code, ANSI/NFPA 70

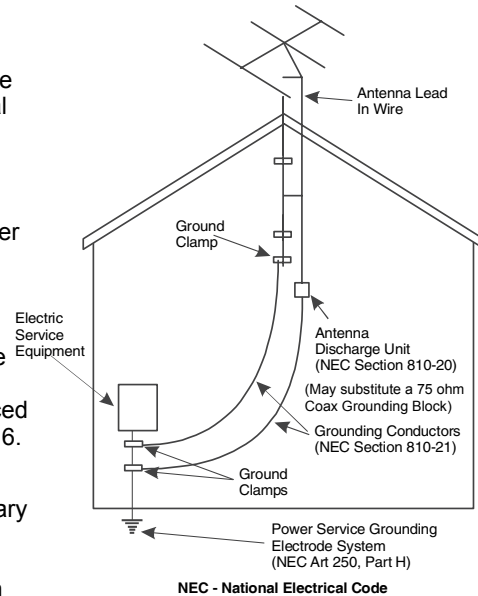



WINEGARD®

769 Series Antennas

Digital/High Definition

VHF/UHF MODELS

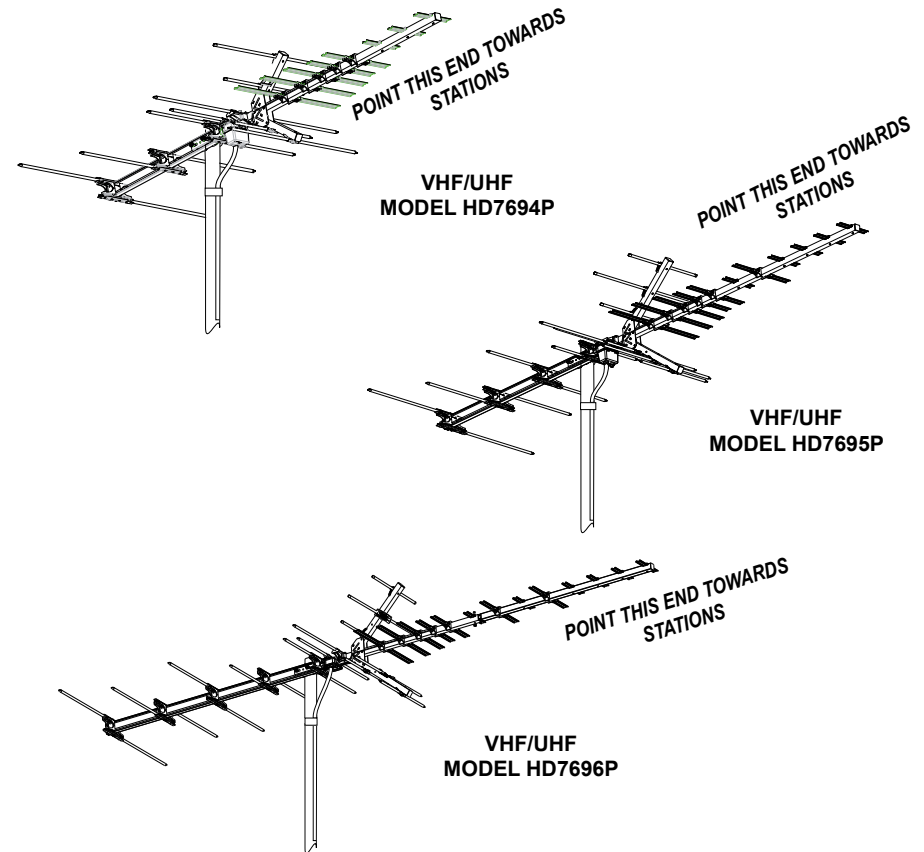
HD7694P, HD7695P, HD7696P



Register your product at winegard.com/myantenna

WARNING

INSTALLATION OF THIS ANTENNA NEAR POWER LINES IS DANGEROUS. FOR YOUR SAFETY, FOLLOW THE INSTALLATION INSTRUCTIONS.

90 DAY LIMITED WARRANTY

Winegard Company warrants this Winegard product against any defects in materials or workmanship within 90 (ninety) days from date of purchase. No warranty claim will be honored unless at the time the claim is made, you present proof of purchase to an authorized Winegard dealer (if unknown, please contact Winegard Company, 3000 Kirkwood Street, Burlington, IA 52601-2000, Telephone 800-288-8094).

Winegard Company (at its option) will either repair or replace the defective product at no charge to you. This warranty covers parts, but does not cover any costs incurred in removal, shipping or reinstallation of the product. This limited warranty does not apply if the product is damaged, deteriorates, malfunctions or fails from: misuse, improper installation, abuse, neglect, accident, tampering, modification of the product as originally manufactured by Winegard, usage not in accordance with product instructions or acts of nature such as damage caused by wind, lightning, ice or corrosive environments such as salt spray and acid rain.

The 90 Day Warranty is provided on the condition that the equipment is properly delivered with all handling and freight charges prepaid to your Winegard dealer for return to our factory for repair or replacement. Winegard dealers will arrange for the replacement or repair and return to you without charge the product which failed due to defective material or workmanship.

WINEGARD COMPANY WILL NOT ASSUME ANY LIABILITIES FOR ANY OTHER WARRANTIES, EXPRESS OR IMPLIED, MADE BY ANY OTHER PERSON.

ALL OTHER WARRANTIES WHETHER EXPRESS, IMPLIED OR STATUTORY INCLUDING WARRANTIES OF FITNESS FOR A PARTICULAR PURPOSE AND MERCHANTABILITY ARE LIMITED TO THE 90-DAY PERIOD OF THIS WARRANTY.

The foregoing shall be the sole and exclusive remedy of any person, whether in contract, tort or otherwise, and Winegard shall not be liable for incidental or consequential damage or commercial loss, or from any other loss or damage except as set forth above.

Some states do not allow limitations on how long an implied warranty lasts, or the exclusion of limitation of incidental or consequential damages, so the above limitations or exclusions may not apply to you.

This warranty gives you specific legal rights and you may also have other rights which vary from state to state.

Rev. 2/08

NOTE:

To prevent damage in shipping, some of the elements are folded to the opposite side of the boom. For maximum performance, you must unfold the elements correctly. Please follow these steps.

STEP 1. Remove the antenna from the carton. (For Model HD7696P, start with the rear section of antenna (long elements). Lay the antenna on the ground with the end with long elements pointing toward you. Starting with the element nearest you, unfold the first element **CLOCKWISE** about 80° and click to lock position. See Figure 1 for the model you have.

STEP 2. Grasp both ends of the second element from the rear of the boom. Lift the ends of the element just enough to slide over the other elements and boom and **ROTATE ABOUT 100° COUNTER CLOCKWISE** to lock. See Figure 1.

STEP 3. Unfold the rest of the elements on this side of the antenna to the lock position, being sure to alternate the elements.

STEP 4. Turn the antenna over and repeat steps 1, 2 and 3. Again lift and rotate the elements that are folded to the opposite side of the boom (for shipping) just enough to slide over the other elements and boom.

Fig. 1 Model HD7694P

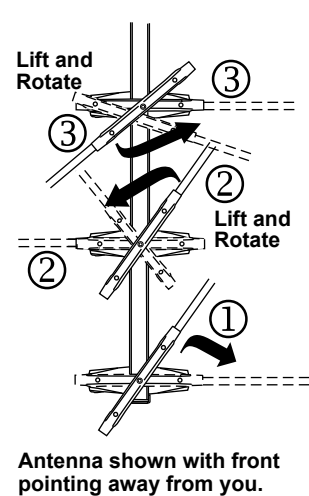

Fig. 1 Model HD7695P

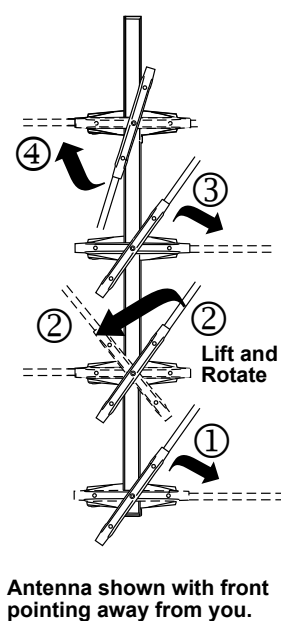
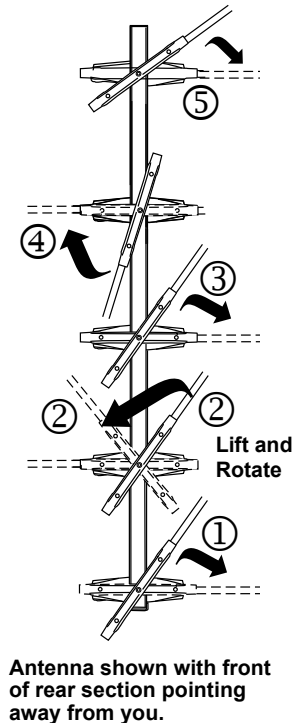

Fig. 1 Model HD7696P



For Model HD7696P.

STEP 5. Unfold the elements of the front section of the antenna. The elements should be on the top side of the front section of the antenna. Remove the bolt, hex nut, and element from the tapered end of the front boom and slide the tapered end into the front of the rear boom. The cartridge housing receptacle on the rear section is attached to the bottom of the rear boom at the factory. Replace bolt, hex nut, and element, tighten securely. Figure 2.

STEP 6. Unfold the reflector booms slowly until they lock in place. Then unfold the elements on the reflector booms. See Figure 3.

STEP 7. To attach the cartridge housing to the antenna, align the snaps on the cartridge housing with the snap holes on the cartridge housing receptacle on the antenna and push the housing into the receptacle until it snaps into place. See Figure 4.

STEP 8. Attach the 75 ohm coaxial downlead cable to the "downlead" connection on the cartridge housing. See Figure 4. Slide weather boot over connectors and boot collar.

STEP 9. Loosen nuts on the mast clamp, slide the antenna over the end of the mast. Point the front of the antenna (small end) towards stations and tighten mast clamp securely. See Figure 5.

STEP 10. The 75 ohm coaxial cable downlead may be secured to the mast by taping or by using plastic wire ties.

Fig. 2 For Model HD7696P.

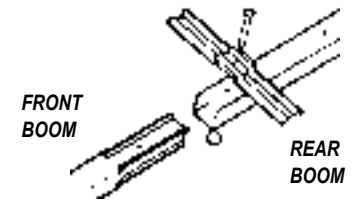

Fig. 3

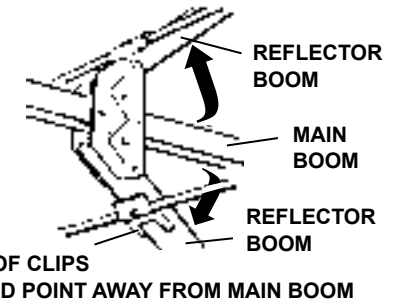

Fig. 4

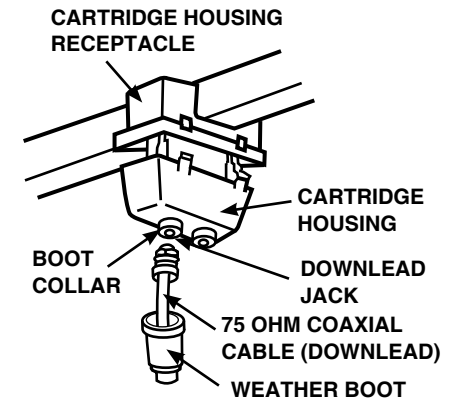
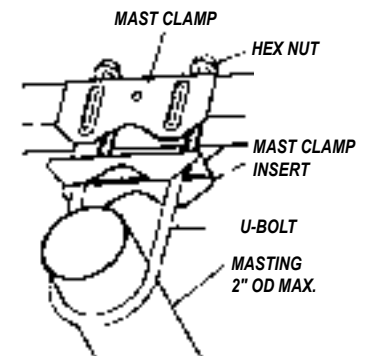

Fig. 5



Free Manuals Download Website

<http://myh66.com>

<http://usermanuals.us>

<http://www.somanuals.com>

<http://www.4manuals.cc>

<http://www.manual-lib.com>

<http://www.404manual.com>

<http://www.luxmanual.com>

<http://aubethermostatmanual.com>

Golf course search by state

<http://golfingnear.com>

Email search by domain

<http://emailbydomain.com>

Auto manuals search

<http://auto.somanuals.com>

TV manuals search

<http://tv.somanuals.com>