

PRO VENTILATION HOODS

USE & CARE INFORMATION

WOLF®



CONTENTS

Introducing Wolf Pro Ventilation Hoods	3
Safety Instructions & Precautions	4
Wolf Pro Ventilation Hood Features	8
Wolf Pro Ventilation Hood Use & Care	14
Wolf Troubleshooting Guide	17
Wolf Service Information	18
Wolf Warranty	19

As you read this Use & Care Information, take particular note of the CAUTION and WARNING symbols when they appear. This information is important for safe and efficient use of the Wolf equipment.

▲ CAUTION

signals a situation where minor injury or product damage may occur if you do not follow instructions.

▲ WARNING

states a hazard that may cause serious injury or death if precautions are not followed.

In addition, this Use & Care Information may signal an IMPORTANT NOTE which highlights information that is especially important.



THANK YOU

Your purchase of a Wolf Pro ventilation hood attests to the importance you place upon the quality and performance of your cooking equipment. We understand this importance and have designed and built your ventilation hood with quality materials and workmanship to give you years of dependable service.

We know you are eager to start cooking, but before you do, please take some time to read this Use & Care Information. Whether you are a beginning cook or an expert chef, it will be to your benefit to familiarize yourself with the safety practices, features, operation and care recommendations of the Wolf Pro ventilation hood.

We appreciate your choice of a Wolf Appliance product and welcome any suggestions or comments you may have. To share your opinions with us, call 800-332-9513.

Your Wolf ventilation hood is protected by a warranty that is one of the finest in the industry. Take a moment to read the warranty statement on page 19 and refer to it should service become necessary.

CONTACT INFORMATION

**Wolf Customer
Service:
800-332-9513**

**Website:
wolfappliance.com**

SAFETY INSTRUCTIONS AND PRECAUTIONS



READ AND SAVE THESE INSTRUCTIONS

- **Read this Use & Care Information carefully** before using your new ventilation unit to reduce the risk of fire, electrical shock or injury to persons.

⚠ WARNING

To reduce the risk of fire, electric shock or injury to persons, observe the following:

- **Use this unit only in the manner intended by Wolf Appliance Company.** If you have questions, contact us at 800-332-9513.
- **Before servicing or cleaning unit, switch power off** at service panel and lock the service disconnecting means to prevent power from being switched on accidentally. When the service disconnecting means cannot be locked, securely fasten a prominent warning device, such as a tag, to the service panel.

- **Installation work and electrical wiring must be done by qualified person(s)** in accordance with all applicable codes and standards, including fire-rated construction codes and standards.
- **Sufficient air is needed for proper combustion and exhausting of gases** through the flue (chimney) of fuel-burning equipment to prevent backdrafting.

⚠ WARNING

To reduce the risk of electric shock, this fan should only be used with fan speed control CM-18RT1 and CM-18RSTU2 (809403), manufactured by Trivar Laboratories, Inc.



⚠ WARNING

To reduce the risk of fire and to properly exhaust air, be certain to duct air outside. Do not vent exhaust air into spaces within walls or ceilings or into attics, crawl spaces or garages.

- **Follow the heating equipment manufacturer's guidelines and safety standards**, such as those published by the National Fire Protection Association (NFPA), the American Society for Heating, Refrigeration and Air Conditioning Engineers (ASHRAE) and the local code authorities.
- **When cutting or drilling into wall or ceiling, do not damage electrical wiring or other hidden utilities.**
- **To reduce the risk of fire or electric shock**, do not use this hood with an additional speed control device.
- **Ducted fans must always be vented to the outdoors.**
- **To reduce the risk of fire, use only metal ductwork.**
- **This unit must be grounded.**
- **For best capture of cooking impurities**, the bottom of the hood should be a minimum of 30" (762) and a maximum of 36" (914) above the countertop.
- **This product may have sharp edges.** Be careful to avoid cuts and abrasions during installation and cleaning.
- **Please read specification label** on product for further information and requirements.

SAFETY INSTRUCTIONS AND PRECAUTIONS



READ AND SAVE THESE INSTRUCTIONS

TO REDUCE THE RISK OF A COOKTOP GREASE FIRE:

- **Never leave surface units unattended at high settings.**
Boilovers cause smoking and greasy spillovers that may ignite. Heat oils slowly on low or medium settings.
- **Always turn hood ON when cooking at high heat** or when flambéing food (i.e. Crepes Suzette, Cherries Jubilee, Peppercorn Beef Flambé).
- **Clean ventilating fans frequently.**
Grease should not be allowed to accumulate on fan or filter.
- **Use proper pan size.** Always use cookware appropriate for the size of the surface element.

WARNING

TO REDUCE THE RISK OF INJURY TO PERSONS IN THE EVENT OF A GREASE FIRE, OBSERVE THE FOLLOWING:

Smother flames with a close-fitting lid, baking sheet or other metal tray, then turn off the gas burner. Be careful to prevent burns. If the flames do not go out immediately, evacuate and call the fire department.

Do not use water, including wet dishcloths or towels—a violent steam explosion will result.

Never pick up a flaming pan—you may be burned.



USE AN EXTINGUISHER ONLY IF:

- **You know you have a Class ABC extinguisher** and you already know how to operate it.
- **The fire is small and contained** in the area where it started.
- **The fire department is being called.**
- **You can fight the fire with your back to an exit** (NFPA Fire Safety Tips).

WARNING

**For general ventilating use only.
Do not use to exhaust hazardous
or explosive materials and vapors.**

- **To avoid motor bearing damage** and noisy and/or unbalanced impellers, keep drywall spray, construction dust, etc., off blower.
- **Two installers are recommended** because of the large size and weight of this hood.
- **Your hood motor has a thermal overload that will automatically shut off the motor if it becomes overheated.** The motor will restart when it cools down. If the motor continually shuts off and restarts, contact a Wolf authorized service center.
- **Avoid using food products that produce flames** under the wall hood or island hood.
- **Take care when using cleaning agents or detergents.**



PRO LOW-PROFILE WALL HOODS

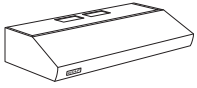

Low-Profile Wall Hood

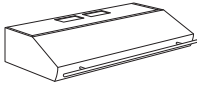

Low-Profile Wall Hood (R) Rail Option

- 22" (559) deep wall ventilation hood available in 30" (762), 36" (914), 42" (1067) and 48" (1219) widths
- Classic stainless steel finish
- Rail option wall hoods (R) come with a classic stainless steel decorative rail and stand-offs—optional platinum or brass rail available to match dual fuel range bezels
- Internal, in-line and remote blower options
- Heavy-duty, 16-gauge brushed stainless steel construction
- Stainless steel enclosed liner
- Continually welded seams, hemmed edges and sides, and hand-finished craftsmanship
- Recessed easy-access controls
- Infinite-speed blower control
- Heat Sentry feature automatically turns unit on when heat is sensed and automatically adjusts blower speed
- Halogen lighting with two settings
- Removable, dishwasher-safe, restaurant-grade stainless steel baffle filters
- Transition with backdraft damper included
- Two and five year residential warranty (exclusions apply); see warranty at the end of this guide

LOW-PROFILE WALL HOOD

Model PW482210R shown

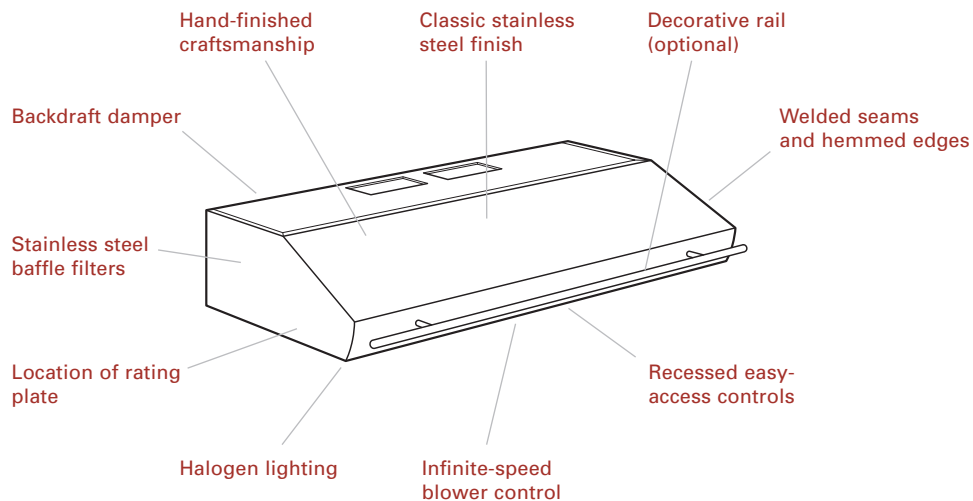



PRO 24" (610) DEEP WALL HOODS

- 24" (610) deep wall ventilation hood available in 30" (762), 36" (914), 42" (1067), 48" (1219), 54" (1372), 60" (1524) and 66" (1676) widths
- Classic stainless steel finish
- Rail option wall hoods (R) come with a classic stainless steel decorative rail and stand-offs—optional platinum or brass rail available to match dual fuel range bezels
- Internal, in-line and remote blower options
- Heavy-duty, 16-gauge brushed stainless steel construction
- Stainless steel enclosed liner
- Continually welded seams, hemmed edges and sides, and hand-finished craftsmanship
- Recessed easy-access controls
- Infinite-speed blower control
- Heat Sentry feature automatically turns unit on when heat is sensed and automatically adjusts blower speed
- Halogen lighting with two settings
- Removable, dishwasher-safe, restaurant-grade stainless steel baffle filters and grease cups
- Transition with backdraft damper included
- Two and five year residential warranty (exclusions apply); see warranty at the end of this guide



24" (610) Wall Hood

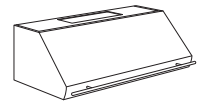

24" (610) Wall Hood (R) Rail Option

24" (610) DEEP WALL HOOD

Model PW482418R shown

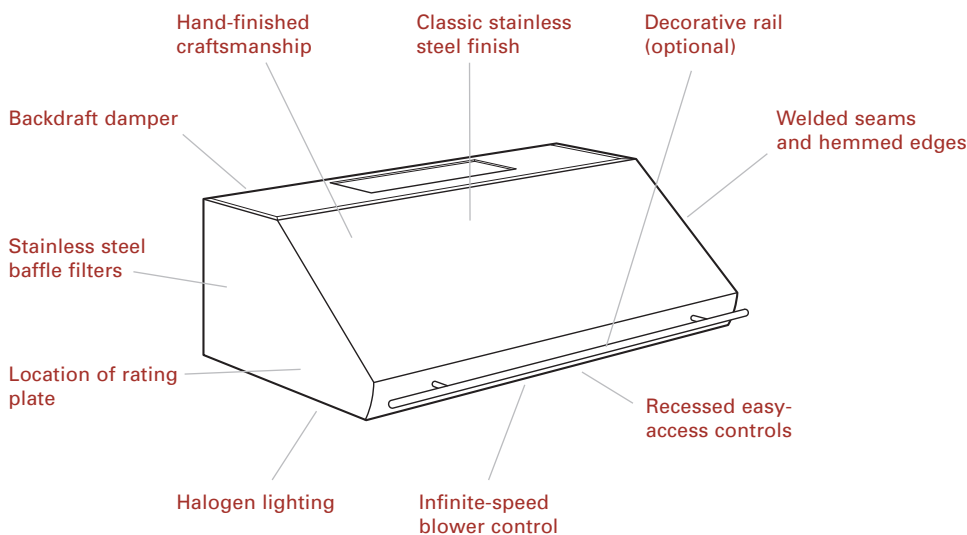

WOLF WARRANTY

Wolf products are covered by a two and five year residential warranty (exclusions apply). See warranty details at the end of this guide.

Dimensions in parentheses are in millimeters unless otherwise specified.



PRO 27" (686) DEEP WALL HOODS



27" (686) Wall Hood

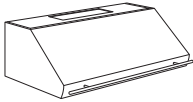

27" (686) Wall Hood (R) Rail Option

- 27" (686) deep wall ventilation hood available in 30" (762), 36" (914), 42" (1067), 48" (1219), 54" (1372), 60" (1524) and 66" (1676) widths
- Classic stainless steel finish
- Rail option wall hoods (R) come with a classic stainless steel decorative rail and stand-offs—optional platinum or brass rail available to match dual fuel range bezels
- Internal, in-line and remote blower options
- Heavy-duty, 16-gauge brushed stainless steel construction
- Stainless steel enclosed liner
- Continually welded seams, hemmed edges and sides, and hand-finished craftsmanship
- Recessed easy-access controls
- Infinite-speed blower control
- Heat Sentry feature automatically turns unit on when heat is sensed and automatically adjusts blower speed
- Halogen lighting with two settings
- Heat lamps—two R40 250-watt maximum bulbs required (bulbs not included)
- Removable, dishwasher-safe, restaurant-grade stainless steel baffle filters and grease cups
- Transition with backdraft damper included
- Two and five year residential warranty (exclusions apply); see warranty at the end of this guide

27" (686) DEEP WALL HOOD

Model PW482718R shown

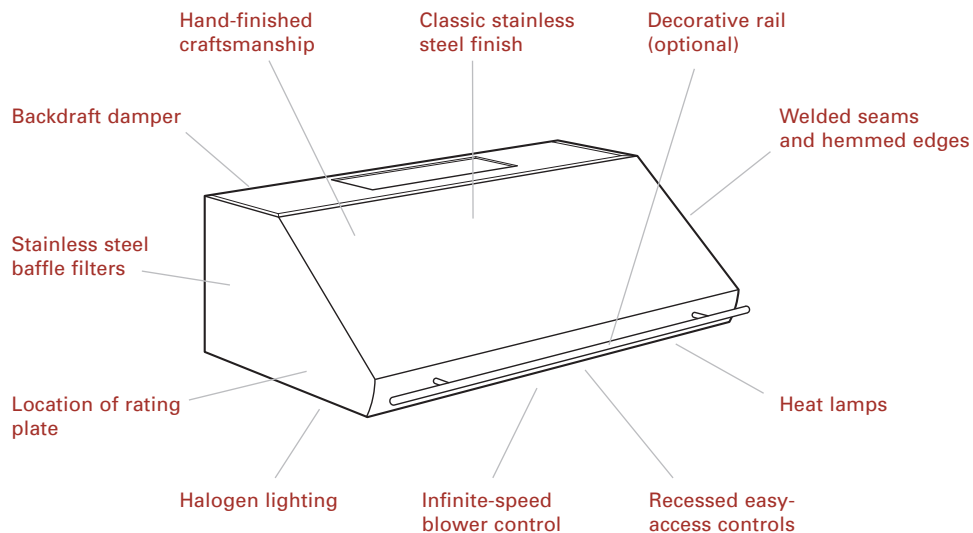



PRO WALL CHIMNEY HOODS

- Wall chimney ventilation hood available in 36" (914), 42" (1067), 48" (1219) and 54" (1372) widths
- Classic stainless steel finish
- Optional 6" (152), 12" (305), 18" (457) and 24" (610) duct covers available to complete the chimney design
- Rail option wall hoods (R) come with a classic stainless steel decorative rail and stand-offs—optional platinum or brass rail available to match dual fuel range bezels
- Internal, in-line and remote blower options
- Heavy-duty, 16-gauge brushed stainless steel construction
- Stainless steel enclosed liner
- Continually welded seams, hemmed edges and sides, and hand-finished craftsmanship
- Recessed easy-access controls
- Infinite-speed blower control
- Heat Sentry feature automatically turns unit on when heat is sensed and automatically adjusts blower speed
- Halogen lighting with two settings
- Removable, dishwasher-safe, restaurant-grade stainless steel baffle filters and grease cups
- Transition with backdraft damper included
- Two and five year residential warranty (exclusions apply); see warranty at the end of this guide

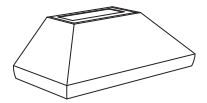

Wall Chimney Hood

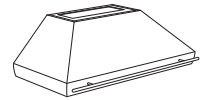

Wall Chimney Hood (R) Rail Option

WALL CHIMNEY HOOD

Model PWC482418R shown

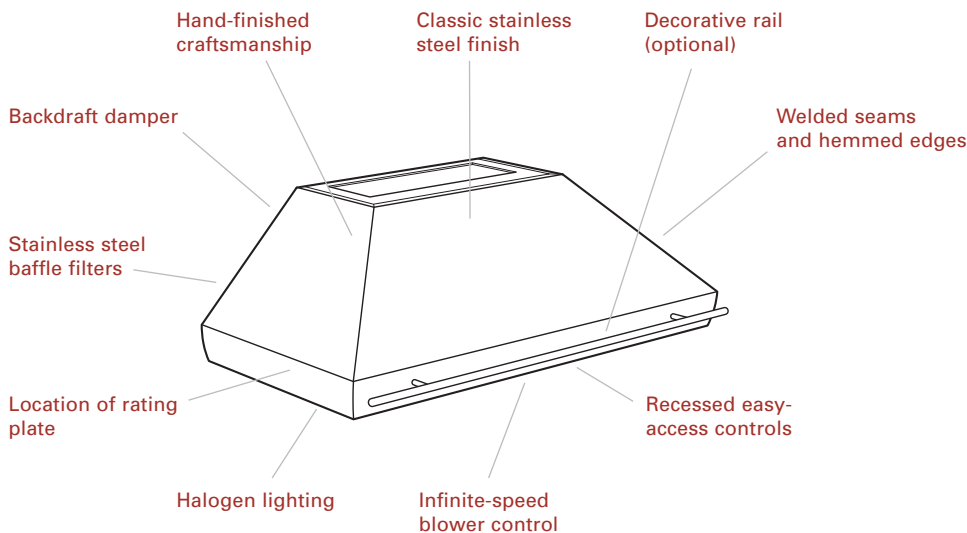

WOLF WARRANTY

Wolf products are covered by a two and five year residential warranty (exclusions apply). See warranty details at the end of this guide.

Dimensions in parentheses are in millimeters unless otherwise specified.

PRO ISLAND HOODS



Island Hood

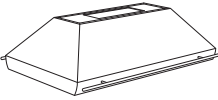

Island Hood (R) Rail Option

- Island ventilation hood available in 36" (914), 42" (1067), 54" (1372) and 66" (1676) widths
- Classic stainless steel finish
- Rail option island hoods (R) come with classic stainless steel decorative rails and stand-offs for both sides of the hood— optional platinum or brass rails available to match dual fuel range bezels
- Internal, in-line and remote blower options
- Heavy-duty, 16-gauge brushed stainless steel construction
- Stainless steel enclosed liner
- Continually welded seams, hemmed edges and sides, and hand-finished craftsmanship
- Recessed easy-access controls
- Infinite-speed blower control
- Heat Sentry feature automatically turns unit on when heat is sensed and automatically adjusts blower speed
- Halogen lighting with two settings
- Removable, dishwasher-safe, restaurant-grade stainless steel baffle filters and grease cups
- Transition with backdraft damper included
- Two and five year residential warranty (exclusions apply); see warranty at the end of this guide

ISLAND HOOD

Model PI543418R shown

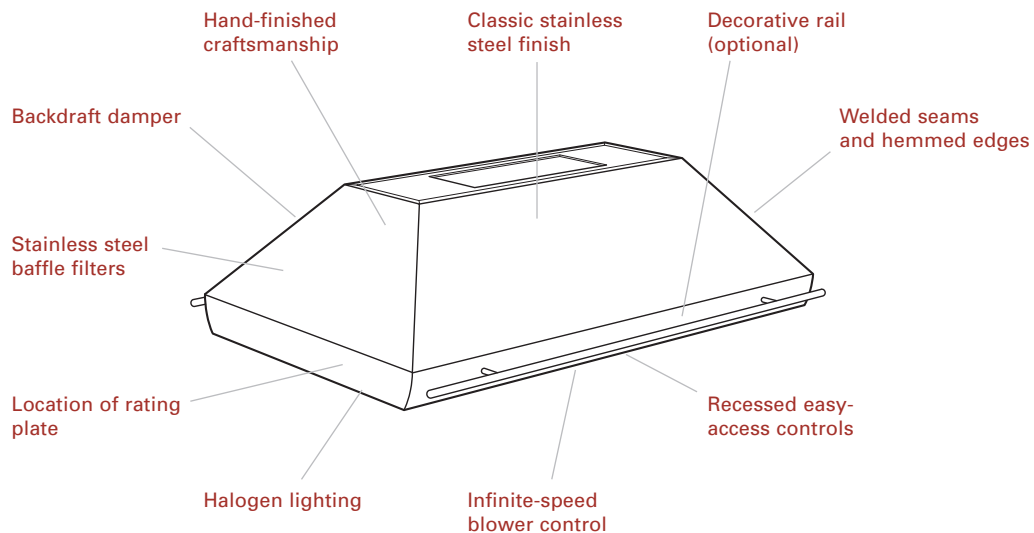



PRO HOOD LINERS

- Stainless steel enclosed liner with seamed construction
- Available for use with 36" (914), 42" (1067), 48" (1219), 54" (1372) and 60" (1524) custom hoods
- Internal, in-line and remote blower options
- Recessed easy-access controls
- Infinite-speed blower control
- Heat Sentry feature automatically turns unit on when heat is sensed and automatically adjusts blower speed
- Halogen lighting with two settings
- Removable, dishwasher-safe, restaurant-grade stainless steel baffle filters
- Transition with backdraft damper included
- Two and five year residential warranty (exclusions apply); see warranty at the end of this guide

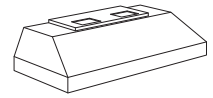

Pro Hood Liner

PRO HOOD LINER

Model PL462212 shown

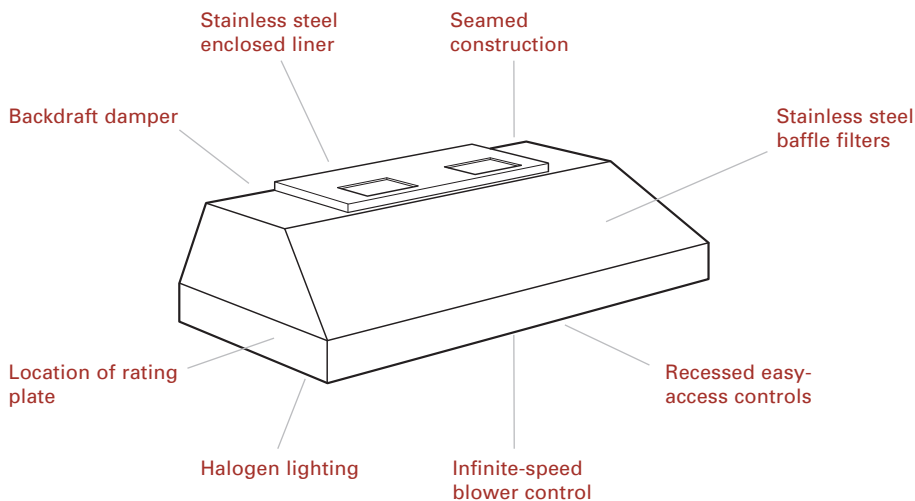

WOLF WARRANTY

Wolf products are covered by a two and five year residential warranty (exclusions apply). See warranty details at the end of this guide.

RECESSED CONTROLS

Controls for Pro ventilation hoods and hood liners are recessed under the front edge of the hood. Refer to the illustration below.

LIGHT CONTROL

The left rotary switch operates the halogen lights. There are two settings, HIGH and LOW. The LOW setting can be used as a night-light. From the OFF position, turn the switch to the desired light setting, left for LOW and right for HIGH light setting.

HEAT LAMP CONTROL

If your hood is equipped with heat lamps, a center rotary switch will control the lamps. Each heat lamp may function independently or both lamps may be activated simultaneously from the single switch. From the OFF position, simply turn the switch to the right to activate the right heat lamp or to the left to activate the left lamp. When the switch is in the vertical position, both heat lamps will be activated.

BLOWER CONTROL

The right rotary switch that operates the blower is variable, allowing infinite control of the blower speed. Rotate the switch fully counterclockwise to turn the blower off.

HEAT SENTRY FEATURE

Heat Sentry feature turns the ventilation hood on when heat is sensed and adjusts the blower speed automatically. The Heat Sentry feature is activated when the exhaust temperature from the hood reaches 200°F (95°C) and deactivated when the exhaust temperature decreases to 186°F (85°C).

At 200°F (95°C) the blower motor will automatically adjust to HIGH speed. When the sensor cools down to 186°F (85°C) it adjusts the blower back to the setting on the blower control. For example, if blower motor is in LOW speed and threshold temperature is reached, the blower will increase to HIGH speed.

FILTER REMOVAL

To remove the stainless steel filters, push each filter up at the angle it is placed in and rotate down. Remove the center filter first. Take out the grease cups (if applicable) placed on the bottom edge of the hood coinciding with the bottom edge of the filters. Gloves should be worn to provide the proper grip. Reinstall using the reverse procedure as shown in the illustration below. Outer filters may need to be pushed over while the center filter is reinstalled.

IMPORTANT NOTE: DO NOT operate the ventilation hood without the filters. This may cause damage to the blower or other internal components of the hood.

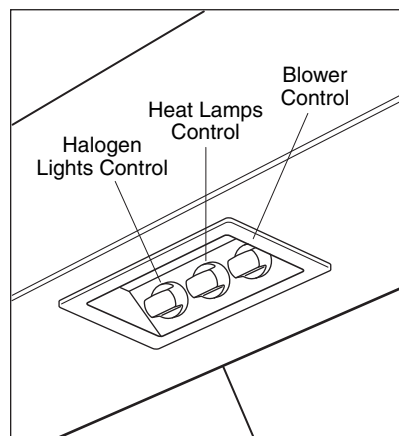

Recessed controls

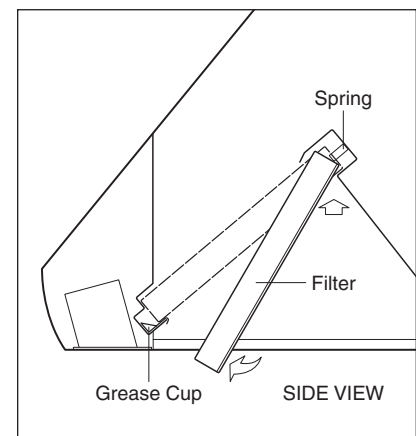

Filter reinstallation—27" (686) deep wall hood shown



HALOGEN LIGHTING

All Wolf Pro ventilation hoods and hood liners have halogen lighting with two settings. Halogen bulbs are included with the hood.

- Pro wall hoods, 30" (762), 36" (914) and 42" (1067) wide require two 50W, 120V par 20 halogen bulbs. 48" (1219), 54" (1372), 60" (1524) and 66" (1676) wide hoods require three 50W, 120V par 20 halogen bulbs.
- Pro wall chimney hoods, 36" (914) and 42" (1067) wide require two 50W, 120V par 20 halogen bulbs. 48" (1219) and 54" (1372) wide hoods require three 50W, 120V par 20 halogen bulbs.
- Pro island hoods, 36" (914) and 42" (1067) wide require two 50W, 120V par 20 halogen bulbs. 54" (1372) and 66" (1676) wide hoods require three 50W, 120V par 20 halogen bulbs.
- Pro hood liners, 34" (864), 40" (1016) and 46" (1168) wide require two 50W, 120V MR-16 halogen bulbs. 52" (1321) and 58" (1473) wide hood liners require three 50W, 120V MR-16 halogen bulbs.

To replace halogen bulbs, turn off the ventilation hood blower and lights. Once the halogen bulb is cool, use a soft cloth to unscrew the bulb and replace.

⚠ CAUTION

Be sure that the bulb is cool before replacing. Halogen bulbs get hot instantly and adjacent parts may retain heat.

HEAT LAMPS

Wolf Pro 27" (686) deep wall hoods are equipped with two heat lamp locations that require R40, 250W maximum bulbs. Heat lamp bulbs are **not included** with the hood.

To replace, turn off the ventilation hood blower and lights. Once the heat lamp bulb is cool, use a soft cloth to unscrew the bulb and replace.

⚠ CAUTION

Be sure that the heat lamp bulb is cool before touching.



CLEANING AND CARE

Most surfaces of your Wolf Pro hood are stainless steel. Although resistant to most stains, it is not totally impervious to damage.

SIGNATURE POLISH

Signature Polish is available from Signature Limited Laboratory, P.O. Box 13436, Dayton, Ohio 45413-0436, or call 877-376-5474 (toll free).

GENERAL CLEANING

- Salt and some cooking liquids may pit and stain the surface. Always remove any film or spills immediately.
- Avoid using abrasive cleaners. They will permanently scratch the surface.
- Do not use steel wool pads.
- Be careful not to soak the rotary switches. Although they are sealed, excessive moisture may cause damage to the controls.
- A spray degreaser will remove fingerprints and greasy spatters. Spray on a cloth and wipe surface. Buff dry immediately to avoid streaking.
- Use white vinegar and water to remove hard water stains.
- Use a clean cloth or sponge, wipe with warm water and mild detergent. Rinse and dry immediately.
- Apply a protective polish like Signature Polish (see side note) to the surface to maintain luster and protect against food stains. Apply the polish following the same grain direction as the finish.

DECORATIVE RAIL

- Clean the decorative hood rail using warm soapy water. Then hand dry with a clean, soft cloth.
- It is not necessary to remove the decorative rail from the hood assembly. It should be cleaned in place.
- Be careful not to pull or hang on the bar, as this could damage the hood assembly.

STAINLESS STEEL FINISH

Use a soft, nonabrasive stainless steel cleaner like Signature Polish (see side note) and apply with a soft lint-free cloth. To bring out the natural luster, lightly wipe the surface with a water-dampened microfiber cloth, followed with a dry microfiber cloth. All work should follow the same grain direction as the finish. Best results are obtained by keeping the cloth in continuous contact with the metal.

⚠ CAUTION

Under no circumstances should you use a metallic or highly abrasive cleaner or cloth, as this will damage the finish.

**CLEANING AND CARE****FILTERS AND GREASE CUPS**

The stainless steel baffle filters and grease cups (if applicable) should be cleaned approximately every month, depending on use. You may need to clean the filters more often if your cooking style generates large amounts of grease (for example, frying or wok cooking).

The filters are dishwasher safe and are designed to fit most dishwashers. Wolf recommends wiping filters and grease cups to remove any excess grease before placing in the dishwasher.

For filter removal and reinstallation, refer to page 14.

TROUBLESHOOTING GUIDE

PROBLEM	POSSIBLE SOLUTION
Motor and lights do not operate	<p>A fuse in your home may be blown or the circuit breaker tripped. Replace the fuse or reset the circuit breaker.</p> <p>Electrical connections at the electrical box may be made incorrectly. Contact your installer.</p>
Motor runs but lights will not operate	<p>The bulb may have burned out.</p> <p>Switch operation may be faulty.</p>
Motor does not function, but lights are operational	<p>Check to ensure blower is plugged into hood receptacle.</p> <p>Connect motor directly to a supply cord, bypassing hood. If the motor runs, contact a Wolf authorized service center to check switch operation and wiring between hood and blower.</p>
Excessive fan speed and/or noise	<p>Check to ensure blower wheel is not hitting side of blower. Adjust if necessary.</p> <p>Check blower mounting hardware. Tighten if necessary.</p> <p>Check for obstructions in damper flap and ductwork.</p> <p>Check for excessive length of duct run, number of transitions and elbows, and duct diameter.</p> <p>Low fan speed adjustment may be needed.</p>

SERVICE INFORMATIONCONTACT
INFORMATION

**Wolf Customer
Service:**
800-332-9513

Website:
wolfappliance.com

When requesting information, literature, replacement parts or service, always refer to the model and serial number of your ventilation hood. This information is found on the product rating plate located inside the left wall of the hood shell. Refer to the illustration for your specific model on pages 8–13 for the location of the rating plate. Record the rating plate information below for future reference.

Model Number _____

Serial Number _____

Installation Date _____

Wolf Authorized Service Center and Phone

Wolf Dealer and Phone

BEFORE CALLING FOR SERVICE

Before calling your Wolf authorized service center, refer to the Troubleshooting Guide on page 17. Check the household fuse or circuit breaker to see if it has been blown or tripped and that the electrical connection to the appliance has not been disconnected. A power outage may also have caused a disruption in service.

PRODUCT REGISTRATION

Register your new Wolf product today so that we may ensure your satisfaction. You may register by one of the following options:

- 1) Mail in the completed Wolf Product Registration Card.
- 2) Register online at **wolfappliance.com**.
- 3) Register by phone by calling the Wolf Customer Service Department at **800-332-9513**.

The model and serial numbers of your appliance are printed on the enclosed Wolf Product Registration Card. If you provide us with your e-mail address, we will send you exciting new product updates and recipes as they become available, along with information on special events.

The information and images are the copyright property of Wolf Appliance Company, Inc., an affiliate of Sub-Zero Freezer Company, Inc. Neither this book nor any information or images contained herein may be copied or used in whole or in part without the express written permission of Wolf Appliance Company, Inc., an affiliate of Sub-Zero Freezer Company, Inc.

©Wolf Appliance Company, Inc. all rights reserved.

WOLF APPLIANCE PRODUCTS LIMITED WARRANTY

RESIDENTIAL USE ONLY

FULL TWO YEAR WARRANTY*

For two years from the date of original installation, your Wolf Appliance product warranty covers all parts and labor to repair or replace any part of the product that proves to be defective in materials or workmanship. All service provided by Wolf Appliance Company under the above warranty must be performed by a Wolf Appliance authorized service center, unless otherwise specified by Wolf Appliance Company. Service will be provided in the home during normal business hours.

LIMITED THIRD THROUGH FIFTH YEAR WARRANTY

From the third through fifth year from the date of original installation, Wolf Appliance Company will repair or replace the following parts that prove to be defective in materials or workmanship. Labor to remove and replace defective parts is not covered. Wolf Appliance Company recommends that you use a Wolf Appliance authorized service center to perform such service.

Gas Burners (excluding appearance), Electric Heating Elements, Blower Motors (vent hoods),
Electronic Control Boards, Magnetron Tubes and Induction Generators

LIMITED LIFETIME WARRANTY

For the life of the product, Wolf Appliance Company will repair or replace any BBQ body or BBQ hood that rusts through due to defective material or workmanship. Labor to remove and replace defective parts is not covered. Wolf Appliance Company recommends that you use a Wolf Appliance authorized service center to perform such service.

TERMS APPLICABLE TO EACH WARRANTY

The warranty applies only to products installed for normal residential use. The warranty applies only to products installed in any one of the fifty states of the United States, the District of Columbia or the ten provinces of Canada. This warranty does not cover any parts or labor to correct any defect caused by negligence, accident or improper use, maintenance, installation, service or repair.

THE REMEDIES DESCRIBED ABOVE FOR EACH WARRANTY ARE THE ONLY ONES THAT WOLF APPLIANCE COMPANY, INC. WILL PROVIDE, EITHER UNDER THIS WARRANTY OR UNDER ANY WARRANTY ARISING BY OPERATION OF LAW. WOLF APPLIANCE COMPANY, INC. WILL NOT BE RESPONSIBLE FOR ANY CONSEQUENTIAL OR INCIDENTAL DAMAGES ARISING FROM THE BREACH OF THIS WARRANTY OR ANY OTHER WARRANTY, WHETHER EXPRESS, IMPLIED OR STATUTORY.

Some states do not allow the exclusion or limitation of incidental or consequential damages, so the above limitation or exclusion may not apply to you. This warranty gives you specific legal rights and you may also have other legal rights that vary from state to state.

To receive parts and/or service and the name of the Wolf Appliance authorized service center nearest you, contact Wolf Appliance Company, Inc., P.O. Box 44848, Madison, Wisconsin 53744; check the Locator section of our website, wolfappliance.com, or call 800-332-9513.

* Stainless Steel (classic, platinum and carbon) doors, panels and product frames are covered by a limited 60 day parts and labor warranty for cosmetic defects.





WOLF APPLIANCE COMPANY, INC. P. O. BOX 44848 MADISON, WI 53744 800-332-9513 WOLFAPPLIANCE.COM

WOLF[®]

810261

2/2007

Free Manuals Download Website

<http://myh66.com>

<http://usermanuals.us>

<http://www.somanuals.com>

<http://www.4manuals.cc>

<http://www.manual-lib.com>

<http://www.404manual.com>

<http://www.luxmanual.com>

<http://aubethermostatmanual.com>

Golf course search by state

<http://golfingnear.com>

Email search by domain

<http://emailbydomain.com>

Auto manuals search

<http://auto.somanuals.com>

TV manuals search

<http://tv.somanuals.com>