



MODEL W1678 26" DOUBLE DRUM SANDER



INSTRUCTION MANUAL

Phone: 1-360-734-3482 • On-Line Technical Support: tech-support@shopfox.biz

COPYRIGHT © MAY, 2003 BY WOODSTOCK INTERNATIONAL, INC.
WARNING: NO PORTION OF THIS MANUAL MAY BE REPRODUCED IN ANY SHAPE OR FORM WITHOUT
THE WRITTEN APPROVAL OF WOODSTOCK INTERNATIONAL, INC.

Printed in Taiwan

WARNING

Some dust created by power sanding, sawing, grinding, drilling, and other construction activities contains chemicals known to the State of California to cause cancer, birth defects or other reproductive harm. Some examples of these chemicals are:

- Lead from lead-based paints.
- Crystalline silica from bricks, cement, and other masonry products.
- Arsenic and chromium from chemically treated lumber.

Your risk from these exposures varies, depending on how often you do this type of work. To reduce your exposure to these chemicals: work in a well ventilated area, and work with approved safety equipment, such as those dust masks that are specially designed to filter out microscopic particles.

TABLE OF CONTENTS

	PAGE
INTRODUCTION	2
About Your New 26" Double Drum Sander	2
Woodstock Service and Support.....	2
Warranty and Returns	3
Specifications	3
SAFETY	4
Standard Safety Instructions	4-5
Additional Safety Instructions for Drum Sanders	6
Avoiding Potential Injuries	7
ELECTRICAL REQUIREMENTS	8
220V Operation	8
Extension Cords.....	8
Grounding	8
ASSEMBLY	10
Unpacking	10
Box Contents.....	10
Shop Preparation	11
Initial Cleaning	11
Beginning	12
Dust Port and Handles	13
Control Box.....	13
Crank and Handle.....	13
ADJUSTMENTS	14
Drums and Pressure Rollers	14
Dust Scoop Gap	20
V-Belt Tension	21
Conveyor Belt	22
OPERATIONS	23
Overview	23
Control Panel	23
Basic Sanding	24
Troubleshooting.....	27
MAINTENANCE	29
General	29
Sanding Belts.....	29
Lubrication	30
Brush Replacement.....	31
Sandpaper Replacement.....	21
Bearing Replacement	32
General Cleaning	34
Wiring Diagram	35
CLOSURE	37
Parts Breakdown and Parts List	38-45

USE THE QUICK GUIDE PAGE LABELS TO SEARCH OUT INFORMATION FAST!





INTRODUCTION

About Your New 26" Double Drum Sander

Your new **SHOP FOX®** W1678 has been specially designed to provide many years of trouble-free service. Close attention to detail, ruggedly built parts and a rigid quality control program assure safe and reliable operation.

The Model W1678 features a 220V single-phase 5 HP motor, dual 4" dust ports, controls for major and micro sanding drum adjustments, amperage measuring load meter, and many other features. Your Double Drum Sander accepts stock up to 4¹/₂" thick by 26" wide, and is capable of completing rough and finish sanding in one pass. For further details refer to the **Specifications** section of this manual on **Page 3**.

Woodstock International, Inc. is committed to customer satisfaction in providing this manual. It is our intent to make sure all the information necessary for safety, ease of assembly, practical use and durability of this product be included.

If you should have any comments regarding this manual, please feel free to contact us at:

Woodstock International, Inc.
Attn: Technical Department
P.O. Box 2309
Bellingham, WA 98227

Woodstock Service and Support

We stand behind our machines! In the event that a defect is found, parts are missing or questions arise about your machine, please contact Woodstock International Service and Support at 1-360-734-3482 or send e-mail to: tech-support@shopfox.biz. Our knowledgeable staff will help you troubleshoot problems, send out parts or arrange warranty returns.

Warranty and Returns

Woodstock International, Inc. warrants all **SHOP FOX**® machinery to be free of defects from workmanship and materials for a period of 2 years from the date of original purchase by the original owner. This warranty does not apply to defects due directly or indirectly to misuse, abuse, negligence or accidents, lack of maintenance, or to repairs or alterations made or specifically authorized by anyone other than Woodstock International, Inc.

Woodstock International, Inc. will repair or replace, at its expense and at its option, the **SHOP FOX**® machine or machine part which in normal use has proven to be defective, provided that the original owner returns the product prepaid to the **SHOP FOX**® factory service center or authorized repair facility designated by our Bellingham, WA office, with proof of their purchase of the product within 2 years, and provides Woodstock International, Inc. reasonable opportunity to verify the alleged defect through inspection. If it is determined there is no defect, or that the defect resulted from causes not within the scope of Woodstock International Inc.'s warranty, then the original owner must bear the cost of storing and returning the product.

This is Woodstock International, Inc.'s sole written warranty and any and all warranties that may be implied by law, including any merchantability or fitness, for any particular purpose, are hereby limited to the duration of this written warranty. We do not warrant that **SHOP FOX**® machinery complies with the provisions of any law or acts. In no event shall Woodstock International, Inc.'s liability under this warranty exceed the purchase price paid for the product, and any legal actions brought against Woodstock International, Inc. shall be tried in the State of Washington, County of Whatcom. We shall in no event be liable for death, injuries to persons or property or for incidental, contingent, special or consequential damages arising from the use of our products.

Every effort has been made to ensure that all **SHOP FOX**® machinery meets high quality and durability standards. We reserve the right to change specifications at any time because of our commitment to continuously improve the quality of our products.

Specifications

Drum Sander Motor	5 HP, 220 VAC, 25 Amp., 3450 RPM, 60 Hertz, Single-Phase
Drum Drive	Dual V-Belt
Drum Size	6" x 27 ³ / ₄ "
Drum Surface Speed	2300 FPM
Drum Rotation.....	Opposite of Feed Conveyor
Conveyor Motor	1/3 HP, 60 VDC, 2 amp., 60 RPM, Variable Speed
Conveyor Drive	Sprocket and Chain
Conveyor Surface Speed	0-20 FPM
Maximum Lumber Dimensions	4 ¹ / ₂ " Thick x 26" Wide
Minimum Lumber Dimensions	1/8" Thick x 9" Long
Dust Port O.D.	4"
Conveyor Table Size	26 ¹ / ₈ " x 30 ¹ / ₄ "
Stand	Cabinet Style, Powder Coated Paint
Bearings	Both Serviceable and Permanently-Lubricated Ball Bearings
Power Control	Magnetic Switch, with Emergency Shut-Down
Footprint	36" x 23 ³ / ₄ "
Shipping Weight	435 lbs.

SAFETY

**READ MANUAL BEFORE OPERATING MACHINE.
FAILURE TO FOLLOW INSTRUCTIONS BELOW WILL
RESULT IN PERSONAL INJURY.**



Indicates an imminently hazardous situation which, if not avoided, **WILL** result in death or serious injury.



Indicates a potentially hazardous situation which, if not avoided, **COULD** result in death or serious injury.



Indicates a potentially hazardous situation which, if not avoided, **MAY** result in minor or moderate injury.

NOTICE

This symbol is used to alert the user to useful information about proper operation of the equipment, and/or a situation that may cause damage to the machinery.

Standard Safety Instructions

1. **Thoroughly read the Instruction Manual before operating your machine.** Learn the applications, limitations and potential hazards of this machine. Keep the manual in a safe and convenient place for future reference.
2. **Keep work area clean and well lighted.** Clutter and inadequate lighting invite potential hazards.
3. **Ground all tools.** If a machine is equipped with a three-prong plug, it must be plugged into a three-hole grounded electrical receptacle or grounded extension cord. If using an adapter to aid in accommodating a two-hole receptacle, ground using a screw to a known ground.
4. **Wear eye protection at all times.** Use safety glasses with side shields or safety goggles that meet the appropriate standards of the American National Standards Institute (ANSI).
5. **Avoid dangerous environments.** Do not operate this machine in wet or open flame environments. Airborne dust particles could cause an explosion and severe fire hazard.
6. **Ensure all guards are securely in place and in working condition.**
7. **Make sure switch is in the OFF position** before connecting power to machine.
8. **Keep work area clean, free of clutter, grease, etc.**
9. **Keep children and visitors away.** Visitors must be kept at a safe distance while operating unit.
10. **Childproof your workshop** with padlocks, master switches or by removing starter keys.
11. **Stop and disconnect the machine when cleaning, adjusting or servicing.**

- 12. **Do not force tool.** The machine will do a safer and better job at the rate for which it was designed.
- 13. **Use correct tool.** Do not force machine or attachment to do a job for which it was not designed.
- 14. **Wear proper apparel.** Do not wear loose clothing, neck ties, gloves, jewelry, and secure long hair away from moving parts.
- 15. **Remove adjusting keys, rags, and tools.** Before turning the machine on, make it a habit to check that all adjusting keys and wrenches have been removed.

16. **Avoid using an extension cord.** But if you must use one, examine the extension cord to ensure it is in good condition. Use TABLE 1 to determine the correct length and gauge of extension cord needed for your particular needs. The amp rating of the motor can be found on its nameplate. If the motor is dual voltage, be sure to use the amp rating for the voltage you will be using. If you use an extension cord with an undersized gauge or one that is too long, excessive heat will be generated within the circuit, increasing the chance of a fire or damage to the circuit. Always use an extension cord that uses a ground pin and connected ground wire. Immediately replace a damaged extension cord.

Extension Cord Requirements
TABLE 1

Amp Rating	Length and Gauge		
	25ft	50ft	100ft
17-20	#12	#12	#10
21-30	#10	#10	N/A

- 17. **Keep proper footing and balance** at all times.
- 18. **Do not leave machine unattended.** Wait until it comes to a complete stop before leaving the area.
- 19. **Perform machine maintenance and care.** Follow lubrication and accessory attachment instructions in the manual.
- 20. **Keep machine away from open flame.** Operating machines near pilot lights or open flames creates a high risk if dust is dispersed in the area. Dust particles and an ignition source may cause an explosion. Do not operate the machine in high-risk areas, including but not limited to, those mentioned above.
- 21. **If at any time you are experiencing difficulties** performing the intended operation, stop using the machine! Then contact our service department or ask a qualified expert how the operation should be performed.
- 22. **Habits—good and bad—are hard to break.** Develop good habits in your shop and safety will become second-nature to you.

⚠ WARNING

Always wear safety glasses or goggles when operating equipment. Operating this equipment creates the potential for flying debris that can cause eye injury. Everyday glasses or reading glasses only have impact resistant lenses, they are not safety glasses. Be certain the safety glasses you wear meet the appropriate standards of the American National Standards Institute (ANSI).





Additional Safety Instructions for Drum Sanders



SHOP FOX
MODEL W1678
26" DOUBLE DRUM SANDER
INSTRUCTION MANUAL

⚠️ WARNING

Read and understand this entire instruction manual before using this machine. Serious personal injury may occur if safety and operational information is not understood and followed. Do not risk your safety by not reading!

⚠️ CAUTION

Use this and other machinery with caution and respect, and always consider safety first, as it applies to your individual working conditions. Remember, no list of safety guidelines can be complete, and every shop environment is different. Failure to follow guidelines can result in serious personal injury, damage to equipment or poor work results.

- **ALWAYS** keep bystanders and yourself away from the infeed and outfeed ends when a workpiece is fed into the sander.
- **ALWAYS** secure aprons, clothing, and long hair away from all sander moving parts.
- **ALWAYS** use a respirator along with a dust collection system when sanding. Dust from some woods is toxic, so make sure you research the dangers of the specific species of wood you will sand.
- **ALWAYS** keep your hands away from the sanding drums during operation, and wear eye and hearing protection.
- **ALWAYS** keep fingers away from the conveyor and the underside of the workpiece during sander and conveyor operation. Otherwise, fingers can get pinched between the workpiece and the conveyor belt, and pull your hand into the machine causing serious injury or death!
- **ALWAYS** adjust the conveyor feed rate and sanding drum height, so when you feed the workpiece into the sander using light pressure, you do not overload the sander. Never force the workpiece into the sander.
- **ALWAYS** shut the sander down, let the drums come to a complete stop, and disconnect power or engage applicable safety-lock devices before you service, adjust, troubleshoot, or leave the machine unattended.
- **ALWAYS** keep this machine in correct adjustment and properly serviced. Never attempt to clear a jammed workpiece while the sander is running.
- **ALWAYS** replace the sandpaper when it is worn, and only use undamaged sandpaper.
- **ALWAYS** inspect the workpiece for nails, staples, knots, imbedded stones, and other material that could be dislodged and thrown from the machine during sanding operations.
- **NEVER** sand if there is any doubt about the stability or integrity of the workpiece.
- **NEVER** sand more than one workpiece at a time.
- **NEVER** sand stock smaller than 1/8" thick x 9" long.
- **NEVER** sand thin stock by using a "sled" (another board) under the workpiece.
- **NEVER** adjust the conveyor belt tracking when the sanding drums are engaged.

Avoiding Potential Injuries



Figure 1. NEVER hold the stock where the conveyor and stock can pinch your fingers.



Figure 2. ALWAYS keep fingers away from conveyor and the underside of the stock.



Figure 3. NEVER stand in the path of potential workpiece kickback.



Figure 4. ALWAYS keep yourself and bystanders away from the path of potential workpiece kickback.



Figure 5. NEVER sand more than one piece of stock at a time.



Figure 6. ALWAYS feed the sander with only one piece of stock at a time.



Figure 7. NEVER sand stock using a “sled” (another board) under the workpiece.



Figure 8. ALWAYS sand the workpiece with it sitting flat against the conveyor belt.

ELECTRICAL REQUIREMENTS

220V Operation

The SHOP FOX® Model W1678 Drum Sander uses one 220 VAC single-phase motor. This sanding drum motor is rated at 5 HP and draws approximately 25 amps under a normal sanding load. The 1/3 HP variable speed conveyor motor uses 60 VDC and draws approximately 2 amps.

Refer to the wiring diagram on Pages 35 and 36, and hard wire the power supply to the sander, or use a NEMA-style L6-30 plug and receptacle as shown in Figure 9. In either case, the supply circuit, circuit breaker, or fuse must be able to carry a load of at least 27 Amps. Remember other machines using this circuit add to the total electrical load applied to the circuit. If this total amperage load exceeds the amperage rating of the circuit breaker or fuse, use a different circuit with a higher amperage rating.

DO NOT modify an existing low-amperage circuit by only replacing the circuit breaker with a breaker rated for a higher amperage. The breaker and the complete circuit must be replaced by a qualified electrician.

Extension Cords

We do not recommend using an extension cord with 220V equipment because the cord can generate heat that may cause fire or circuit damage. If you must use an extension cord, use the guidelines listed below and TABLE 2 to determine the correct cord length and gauge. The amp rating of both motors combined is 27 amps at normal operation; however, the amperage will increase or decrease depending on the load you apply on the Double Drum Sander.

- Use a Standard Service (Grade S) cord or better
- Use a cord that is 50 feet or less only
- Use a cord with a NEMA-style L6-30 plug
- Use an undamaged cord only

Extension Cord Requirements
TABLE 2

Amp Rating	Length and Gauge		
	25ft	50ft	100ft
17-20	#12	#12	#10
21-30	#10	#10	N/A

Grounding

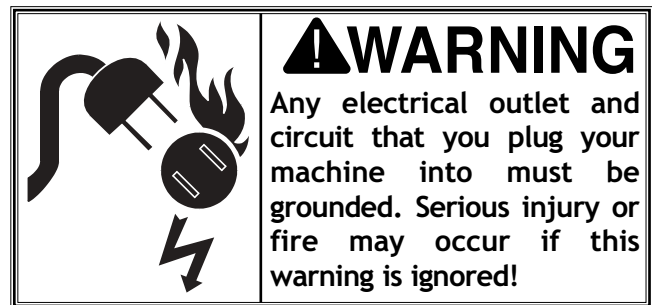

Ground this machine! The electrical cord supplied with the Model W1678 does not come with a 220 volt plug. Use a plug with a ground pin as shown in Figure 9. If your receptacle does not accommodate a NEMA-style L6-30 plug with a ground pin, have the receptacle replaced by a qualified electrician or have an appropriate adapter installed and grounded properly.



Remember, an adapter with a grounding wire does not guarantee the machine will be grounded. A ground source must always be verified in the electrical circuit within the wall or conduit.

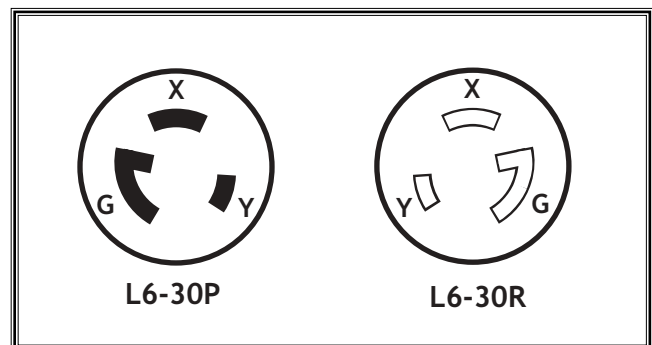
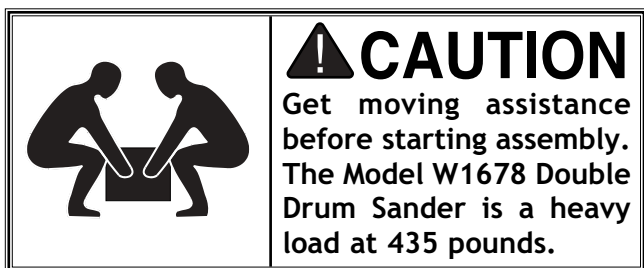

Figure 9. NEMA-style L6-30 plug and receptacle.

ELECTRICAL

ASSEMBLY

Unpacking



The Model W1678 26" Double Drum Sander is carefully packed. However, if it is damaged or is missing any parts, please contact Woodstock International Service and Support at 1-360-734-3482 or send e-mail to: tech-support@shopfox.biz.

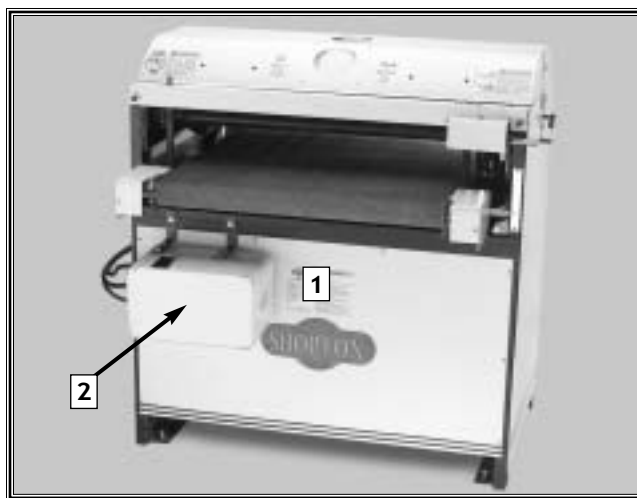

Figure 10. W1678 26" Double Drum Sander

Box Contents

Lay out and inventory the shipped parts to familiarize yourself with your Model W1678 26" Double Drum Sander. See Figures 10 and 11. This will help with the machine assembly.

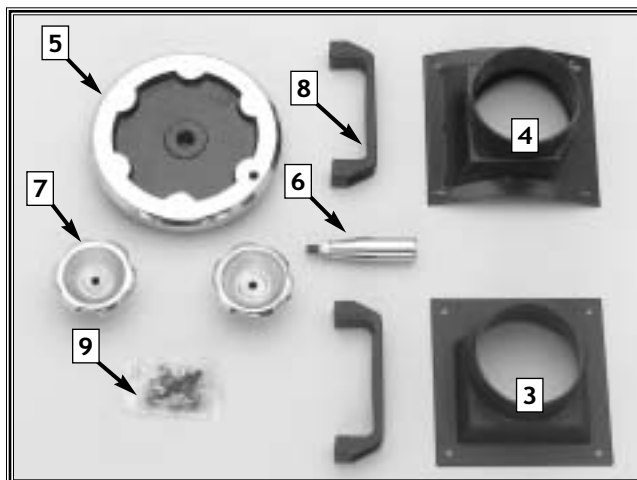

Figure 11. Components

Item	Qty.
1. W1678 26" Double Drum Sander	1
2. Control Box	1
3. Dust Port (Flat Base)	1
4. Dust Port (Concave Base)	1
5. Crank Wheel	1
6. Crank Handle	1
7. Hand Knob	2
8. Handle	2
9. Bolt and Wrench Bag:	1
• Self Tapping Screw (#8 X 1/2")	8
• Flat Washer (#10)	8
• Cap Screw (5/16"-18 X 1")	4
• Lock Washer (5/16")	4
• Hex Nut (5/16"-18)	4
• Set Screw (5/16"-18 X 1/2")	1
• Set Screw (1/4"-20 X 5/16")	2
• Allen® Wrench (3 mm)	1
• Allen® Wrench (4 mm)	1
• Allen® Wrench (6 mm)	1

Shop Preparation

	<p>⚠ CAUTION Make sure shop entrances are locked and machines are equipped with safety lock-out devices when not in use. DO NOT allow untrained people in your shop! Otherwise, injury or death can occur.</p>
---	---

- **Machine Mobility:** If you need to move your drum sander or other machinery to achieve any of the following requirements, Woodstock International Inc. offers a line of **SHOP FOX®** Mobile Bases. For your drum sander, use the **SHOP FOX®** Super Heavy-Duty Mobile Base (Model Number D2058) and the **SHOP FOX®** 36" Extension Bars (Model Number D2246).
- **Double Drum Sander Location:** Choose a location where, if a workpiece should be ejected, you or bystanders will not be struck. Take all necessary safety precautions.
- **Working Clearances:** Consider your current and future needs with respect to the size of lumber to be processed at each machine, space for auxiliary stands, work tables, and other machinery.
- **Lighting:** Make sure your lighting eliminates shadows and prevents eye strain.
- **Outlets:** Make sure electrical circuits are dedicated or large enough to handle the amperage requirements of the new machinery. Electrical outlets should be located near each machine so power or extension cords are clear of high-traffic areas.



Initial Cleaning

If the sander has any dust or slight stains from shipping, **DO NOT** use a mineral-spirit solvent or chlorine-based cleaner to clean any painted or plastic surface, or the rubber conveyor belt. If you do, you will permanently ruin the surface. Instead, use a clean moist towel dampened with mild dish soap and water to clean these surfaces.

If the sander has any grease spots which may have fallen on metal parts from a drum bearing during shipping, read and understand the following Warnings and Cautions, and then use mineral spirits to remove the excess grease. Then coat the cleaned metal surface with a light coat of machine oil to prevent corrosion.

	<p>⚠ WARNING Never use flammables such as gas or other petroleum-based solvents to clean your machine. These products have low flash points and present the risk of explosion and severe personal injury!</p>
---	--

	<p>⚠ WARNING Never smoke while using cleaning solvents. Smoking may cause explosion or risk of fire when exposed to these products!</p>
--	--

	<p>⚠ CAUTION Most solvents used to clean machinery are toxic when inhaled or ingested. When using these products, work in a well ventilated area and keep away from any potential ignition sources (pilot lights). Always dispose of waste rags in a sealed container to make sure they do not cause fire or environmental hazards.</p>
	
	

ASSEMBLY

Beginning

The main components of the Model W1678 are assembled at the factory; however, some assembly is required. We recommend the following sequence in this section for assembly.

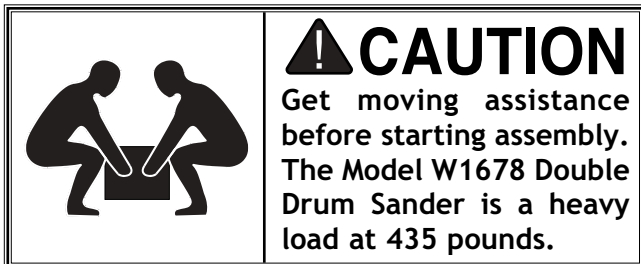
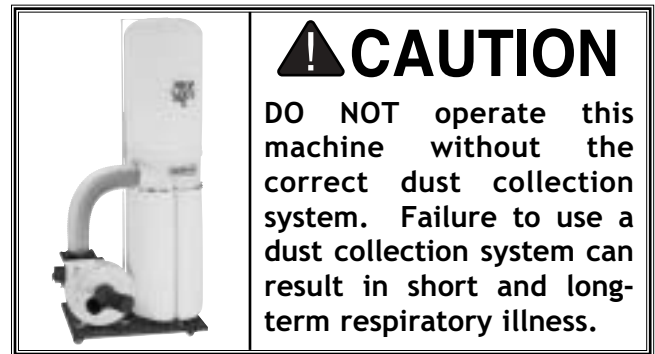

Figure 12. Dust ports and handles installed.

Dust Port and Handles

When connected to a dust collection system, the dust ports direct suction to remove harmful wood and abrasive dust from the workpiece and your work area.



Make sure the dust collection system draws at least 600 CFM at the drum sander; however, there will still be a normal layer of dust on the workpiece when it exits the sander unless a larger capacity dust collector is used.

Make sure you connect flexible ducting to the dust ports. This ducting allows you to open the dust hood, change sandpaper, and service your sander without having to disconnect the ducting.

For additional information on the correct dust collection system, additions, or modifications; contact your Woodstock International dealer for your copy of the *Dust Collection Basics* handbook and available accessories.

To install dust ports and handles, do these steps:

1. Position the dust ports on the dust hood so the screw holes line up. See Figure 12.
2. With the dust ports held in position on the dust hood, install the #10 flat washers on the #8-1/2" self tapping screws and secure the dust ports to the dust hood.
3. Connect your dust collection suction hose to the dust ports, so when you open the dust hood the suction hoses will not bind, leak, or disconnect the dust-collector ducting ground.
4. Position the handles on the dust hood and install the 5/16"-18 x 1" cap screws, the 5/16" lock washers, the 5/16" nuts, and tighten the cap screws. See Figure 12.

Control Box

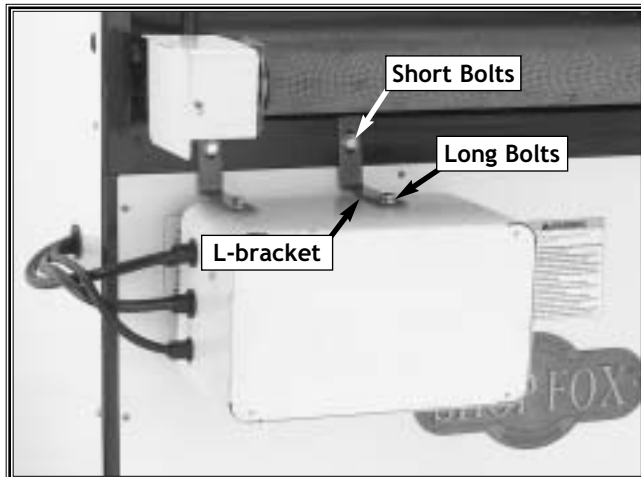

Figure 13. The control box, L-brackets, and bolts for shipping.

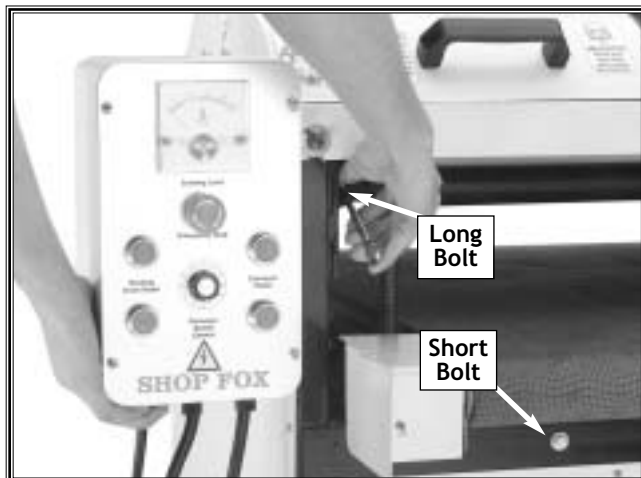

Figure 14. Short and long bolt locations.

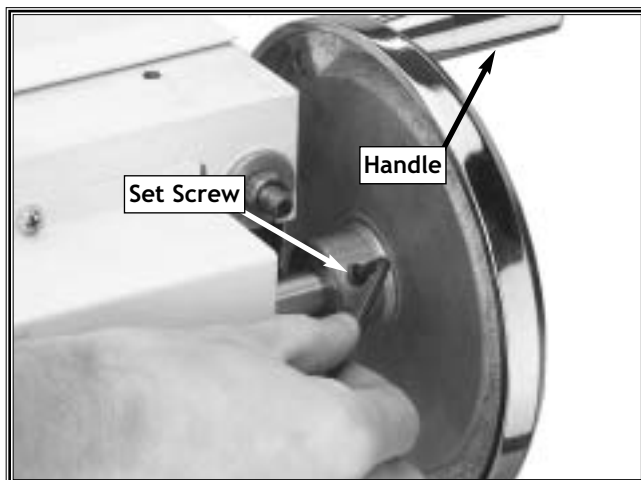

Figure 15. The crank and handle installed.

The control panel allows you to control the sander electrically. For shipping, the control box comes bolted to the sander with L-brackets and long and short bolts. Retain these brackets should you ever need to ship the sander. See **Figure 13**.

To install the control box, do these steps:

1. Remove the L-brackets, bolts, and washers, and reinstall the two short bolts ($\frac{5}{16}$ "-18 x $\frac{1}{2}$ ") and washers into the sander. See **Figure 14**.
2. Position the control box on the sander, install the flat washers and the $\frac{5}{16}$ "-18 x 2" long bolts.
3. Tighten the bolts. See **Figure 14**.

Crank and Handle

The crank and handle is used to raise and lower the conveyor. For each revolution of the crank, the conveyor moves 0.021".

To install the crank and handle, do these steps:

1. Thread the handle into the crank and use a $\frac{1}{2}$ " wrench to tighten the handle to the crank.
2. Slide the handwheel onto the shaft and align the threaded set screw bore on the crank with the flat on the shaft.
3. Thread the $\frac{5}{16}$ "-18 x $\frac{1}{2}$ " set screw into the crank to secure the handwheel to the shaft. See **Figure 15**.
4. Use the 4 mm Allen® wrench and tighten the set screw.

ADJUSTMENTS

Drums and Pressure Rollers

⚠️ WARNING

Adjust the sanding drums and pressure rollers correctly. Complete PART 1, PART 2, PART 3, and PART 4 of this section in sequence. Otherwise, the sanding drums can grab and project the workpiece damaging the sander, and injuring you and bystanders!

To get the best sanding results and longest life out of your sandpaper, both the front and rear sanding drums must: (1) be square with the conveyor table, (2) run parallel with each other and parallel to the conveyor feed direction, and (3) must be slightly staggered in height with one another. Pressure-roller spring tension and height must also be set correctly.

As you become more familiar with your sander you can vary your sander settings to fine-tune the machine for your ultimate sanding goals.

	<h3>⚠️ WARNING</h3> <p>Keep your drum sander unplugged during these adjustments. Otherwise, serious personal injury may occur!</p>
--	---

PART 1: Drum-to-Conveyor Squareness

For this adjustment, you will align the drums so the drums are square with the feed conveyor belt surface. See Figure 18.

To adjust the drum-to-conveyor squareness, do these steps:

1. Make two gauge blocks from a quality piece of straight two-by-four hardwood stud. One block should be 30" long, and the other 2⁵/₈" long. See Figure 16.
2. Unplug the Double Drum Sander!
3. Unlatch and open the dust hood. See Figure 17.

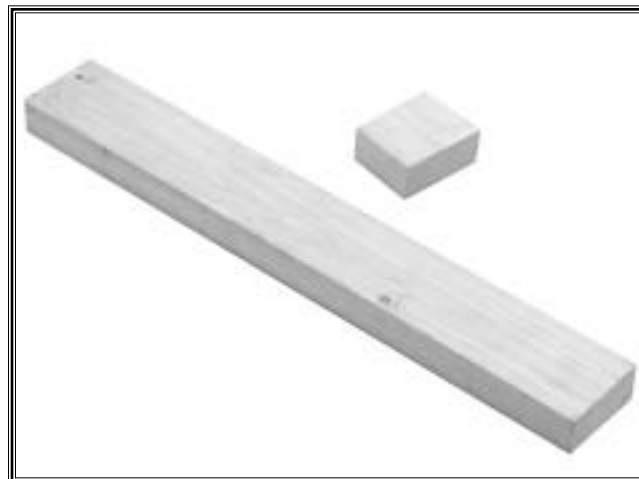

Figure 16. Gauge blocks for drum alignment.



Figure 17. W1678 dust hood open.

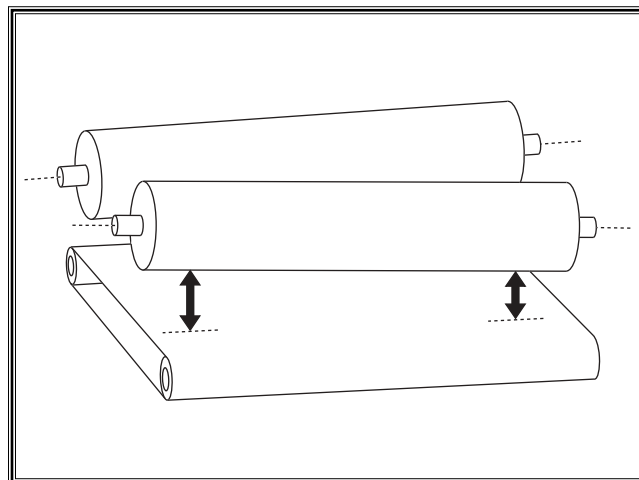

Figure 18. Drums to conveyor not square.

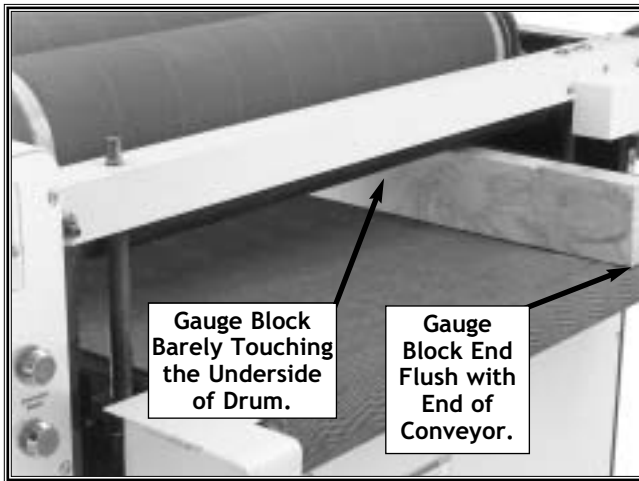

Figure 19. The 30" gauge block positioning.

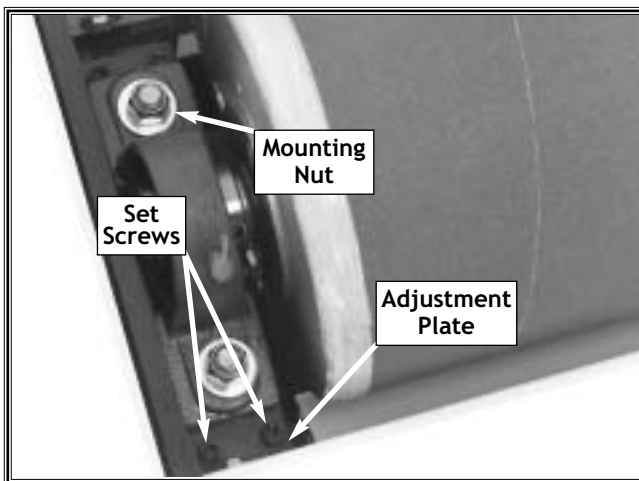

Figure 20. Front bearing block, nuts, and set screw tightening sequence.



Figure 21. Rear drum micro adjustment knob and lock lever.

4. Lower the conveyor table and position the 30" gauge block under one end of the front drum and flush with the end of the conveyor. See **Figure 19**.
5. Turn the micro adjusting knob and raise the rear drum so it will not contact the gauge block.
6. Rotate the front drum by hand, and raise the conveyor table until you hear the gauge block barely rub the underside of the front drum.
7. Move the gauge block to the other side of the conveyor table under the other end of the front drum.
8. Rotate the drum again and listen and feel the drag to determine which end of the drum is too low or high.
9. At the low end of the drum, loosen the bearing-block mounting nuts $\frac{1}{4}$ to $\frac{1}{3}$ turn. See **Figure 20**.

NOTICE

DO NOT over-tighten the bearing block mounting nuts. The bearing blocks are machined housings that can warp or crack if the nuts are over-tightened.

10. Use a 4 mm Allen® wrench to equally turn the set screws at one end of each adjustment plate $\frac{1}{8}$ " turn at a time to raise the bearing block height at the low end of the drum. Remember, adjusting one drum-end slightly affects the adjustment at the opposite end. See **Figure 20**.
11. Repeat **Steps 1** through **10** to achieve front drum-to-conveyor squareness.
12. Tighten the nuts in an alternating pattern and recheck the squareness.
13. Now use the 30" gauge block at the rear drum to find which end is too low.
14. Unlock the micro-adjustment lock knob, and turn the micro-adjust knob to adjust the rear drum height. See **Figure 21**. Unlike the front drum, there are no set screws to adjust the rear drum height.

ADJUSTMENTS

PART 2: Drum-to-Conveyor Parallelism

For this adjustment, you will align the front drum so the sanding path runs parallel with the conveyor belt feed path. You will then align the rear drum to the front drum so it is parallel with the front drum. See **Figure 22**.

NOTICE

If the drum-to-conveyor parallelism is out of adjustment, the sandpaper may become loose and load-up over to one side of the drum(s).

To adjust the drum-to-conveyor parallelism, do these steps:

- At either end and at the surface of the front drum, measure the distance between the drum and the front brace. It should be approximately $\frac{1}{2}$ ". See **Figure 23**.
 - If the difference between the two measurements is less than $\frac{1}{8}$ ", skip **Steps 2** through **4**, and go to **Step 5**.
 - If the distance is greater than $\frac{1}{8}$ ", go to **Step 2**.
- Loosen the bearing-block mounting nuts on one end of the front drum. See **Figure 24**.

NOTICE

DO NOT over-tighten the bearing block mounting nuts. The bearing blocks are machined housings that can warp or crack if the nuts are over-tightened.

- Slide the drum and bearing block forward or rearward to eliminate any front-drum to front-brace measurement difference. Remember, adjusting one drum-end slightly affects the adjustment at the opposite end.
- Tighten the nuts, recheck the measurement, and readjust as necessary.

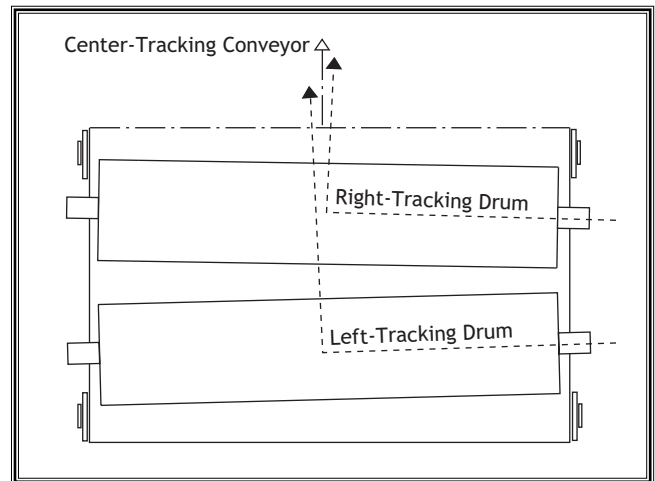

Figure 22. Drums to conveyor path not parallel.

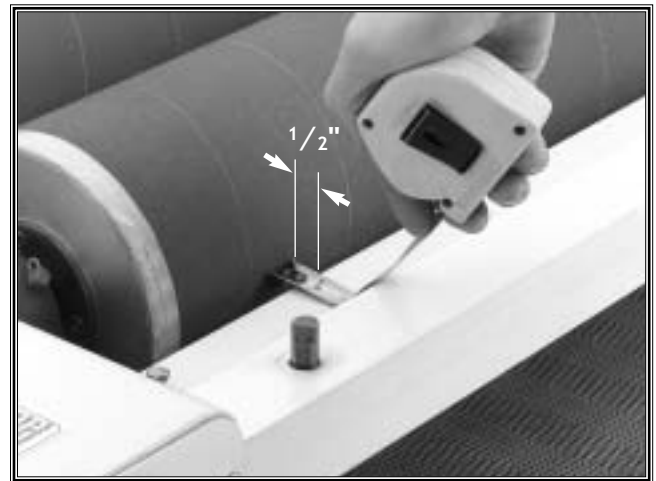

Figure 23. Front-drum to front-brace measurement.

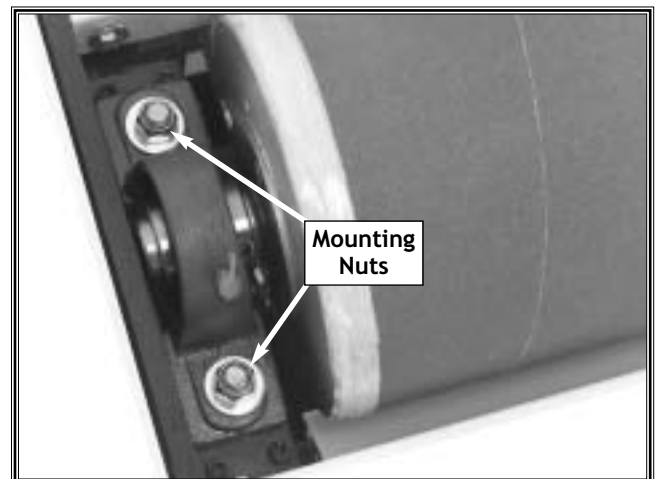

Figure 24. Front bearing block and nuts.

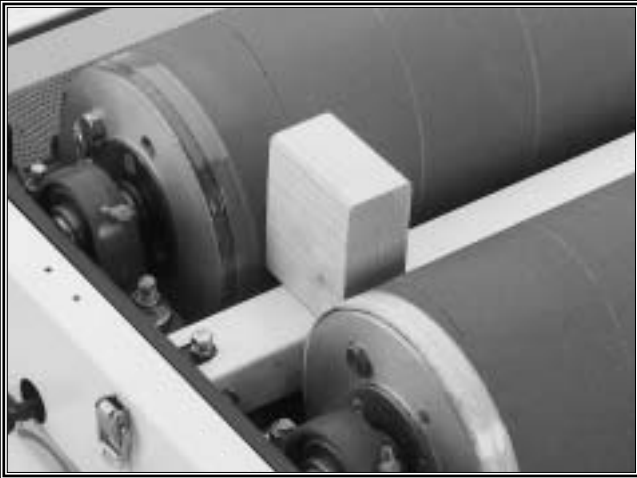

Figure 25. The $2\frac{5}{8}$ " gauge block positioning.

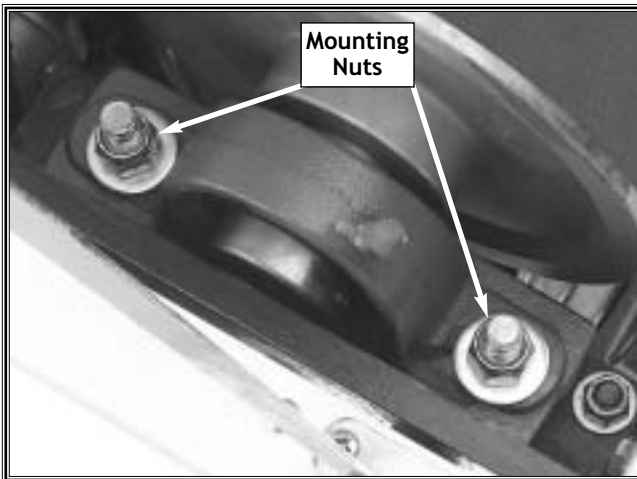

Figure 26. Rear bearing block and nuts.

5. At one end of the rear drum, place the $2\frac{5}{8}$ " gauge block on the dust collector bar and between both drums. Your goal is to slide the rear drum against the block so the rear drum sanding path runs true with the front drum, which now runs true with the conveyor feed path. See **Figure 25**.
6. Loosen the left bearing-block mounting nuts at the end of the rear drum just enough to slide the bearing block. See **Figure 26**.
7. Slide the rear drum and bearing block forward until it stops against the $2\frac{5}{8}$ " gauge block that is sandwiched between the two drums. The gauge block should just be snugly held against the front drum.

NOTICE

DO NOT over-tighten the bearing block mounting nuts. The bearing blocks are machined housings that can warp or crack if the nuts are over-tightened.

8. Tighten the nuts in an alternating pattern.
9. Repeat **Steps 5** through **8**, on the opposite end of the rear drum. Alternate the adjustment until the $2\frac{5}{8}$ " gauge block has the same snug fit between the drums at both ends. The difference between ends must be less than $\frac{1}{8}$ ". Remember, adjusting one drum-end slightly affects the adjustment at the opposite end.

NOTICE

Make sure the drive belts still have the correct tension. If they are out of adjustment, adjust as outlined in the **V-Belt Tension** procedure on **Page 21**.

PART 3: Drum-to-Conveyor Height

For this adjustment, you will find a reference height for the front drum and then adjust the rear drum so it is 0.007" to 0.010" lower than the front drum. See **Figure 27**.

NOTICE

Make sure you use the same part of the 30" gauge block at the opposite side of the conveyor belt when adjusting the drum-to-conveyor height. Otherwise, the adjustment may be inconsistent.

To adjust the drum-to-conveyor height, do these steps:

1. Lower the conveyor table, and position the 30" gauge block to one side of the conveyor belt and flush with the end of the feed conveyor drive roller. See **Figure 28**.
2. Raise the conveyor table so the gauge block barely touches the front drum and mark this height position with tape on the handwheel at the 12:00 o'clock position. See **Figure 29**.
3. Turn the handwheel counter-clockwise exactly $\frac{1}{2}$ turn to lower the conveyor.
4. Unlock the rear-drum micro-adjusting lock lever and turn the micro-adjusting knob so the rear drum lowers until it just barely touches the gauge block.
5. Repeat **Step 14** at both ends of the rear drum.

NOTICE

Once the rear drum height is set, the height can be fine-tuned later without having to complete all four parts of this section. However, you must make sure that when you adjust the rear drum height you adjust it equally on both sides so it stays square and level with the conveyor table. Using a pencil, mark a squiggly line on the workpiece and sand it to test for even sanding. Look for uniform removal of the line. If the line is not removed uniformly, readjust the sander accordingly.

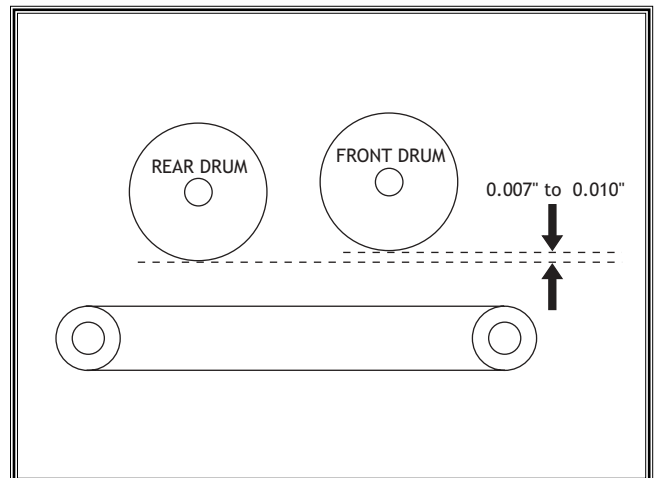

Figure 27. Drum-to-conveyor height.



Figure 28. The 30" gauge block positioning.

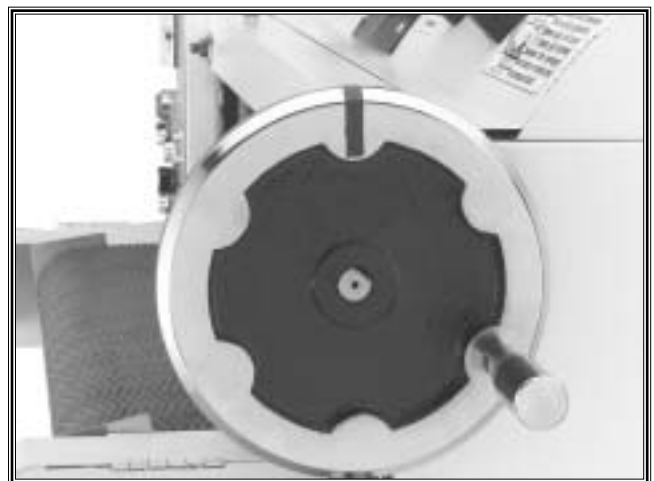

Figure 29. Marked height handwheel.

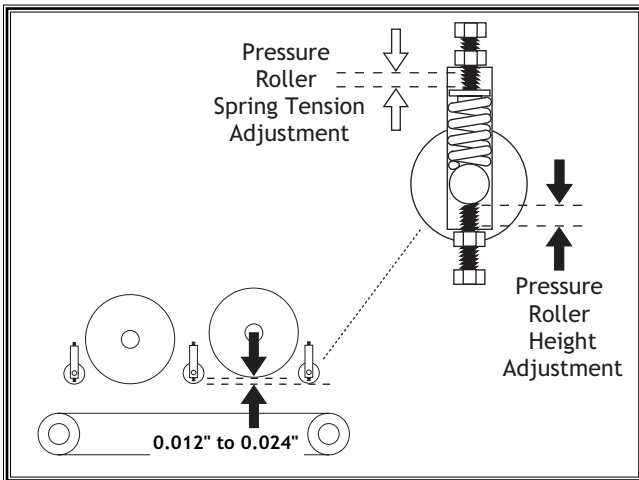

Figure 30. Pressure Roller Adjustment.

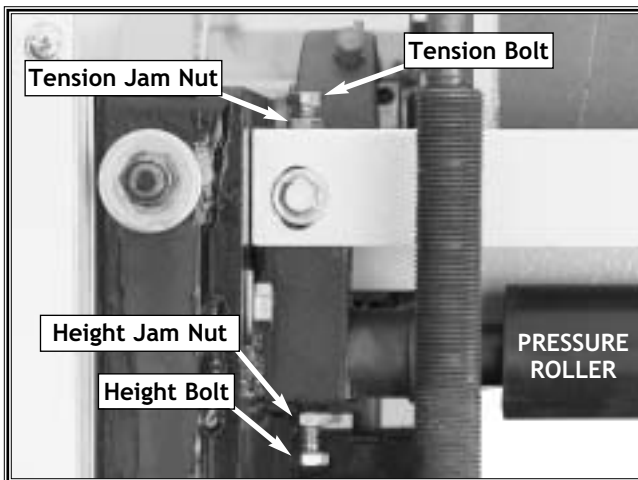

Figure 31. Pressure roller tension and height bolts and jam nuts.



Figure 32. The 30" gauge block positioning.

PART 4: Pressure Roller Adjustment

Depending on your sanding needs, adjust the pressure roller height and spring tension. See Figure 30.

To adjust pressure-roller height, do these steps:

1. Loosen all six height jam nuts. See Figure 31.
2. Position the 30" gauge block to one side of the conveyor belt and under the three pressure rollers. See Figure 32.
3. Turn the handwheel so the gauge block barely touches the rear drum and the handwheel tape is at the 12:00 position.
4. Now turn the handwheel counter-clockwise exactly 2½ turns.
5. Turn the pressure-roller height bolt until the pressure roller just contacts the gauge block. See Figure 31.
6. Hold the height bolt in position and tighten the height jam nut.
7. Repeat Steps 1 through 6 at all rollers, and remove the gauge block.

To adjust pressure-roller spring tension, do these steps:

1. Loosen all six tension jam nuts, and back out the tension bolt completely. See Figure 31.

NOTICE

Too much pressure roller tension may cause the workpiece to jam.

2. Turn the tension bolt clockwise until it just makes contact with the spring and has resistance.
3. Turn the bolt one additional turn to adjust the spring to a basic spring tension value.
4. Hold the tension bolt in position and tighten the tension jam nut.
5. Repeat Steps 2 through 4 at all rollers.
6. Close and latch the dust hood, and check the V-belt tension.

Dust Scoop Gap

For this adjustment, you will adjust the dust scoops so they can efficiently focus dust collection system suction where the most dust is created as the workpiece travels through the drum sander. You will set the dust scoops above the bottom of the drums. See **Figure 33**.



WARNING
 Keep your drum sander unplugged during all assembly, maintenance, and adjustment tasks. Ignoring this warning can cause serious personal injury to you or others!



To adjust the dust scoop gap, do these steps:

1. Unplug the Double Drum Sander.
2. Unlatch and open the dust hood.
3. Insert two gauge blocks (two 30" two-by-fours) of equal height under the sanding drum and dust scoop. See **Figure 35**.
4. Raise the table until the rear drum just touches the gauge blocks.
5. Loosen the dust scoop mounting bolts and slide the scoop up or down until it is $\frac{1}{32}$ " above the gauge blocks. See **Figure 34**. You may have to bend the lip of the dust scoop to get the appropriate gap.
6. Tighten the dust scoop mounting bolts.
7. Repeat **Steps 5 and 6** on all dust scoop ends.
8. Close the dust hood and latch it shut.

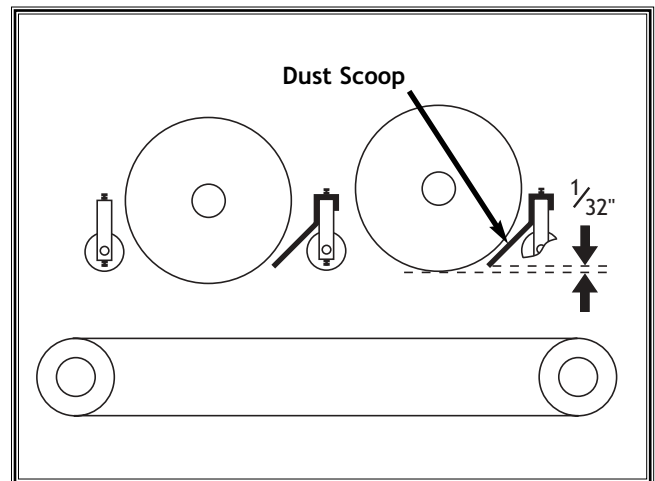

Figure 33. Dust scoop gap.

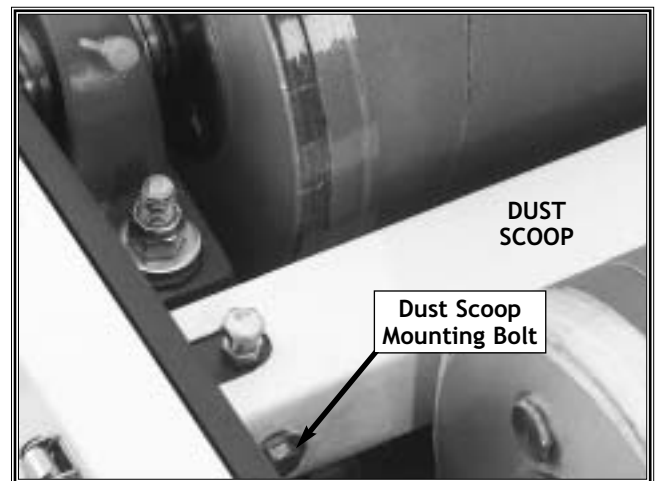

Figure 34. Dust scoop and bolt.



Figure 35. Two gauge blocks in position.

V-Belt Tension

The sanding drums are driven by two heavy-duty V-belts. After drum adjustments and normal operation, the belts may need adjustment. The belt looseness or deflection must be approximately 1".

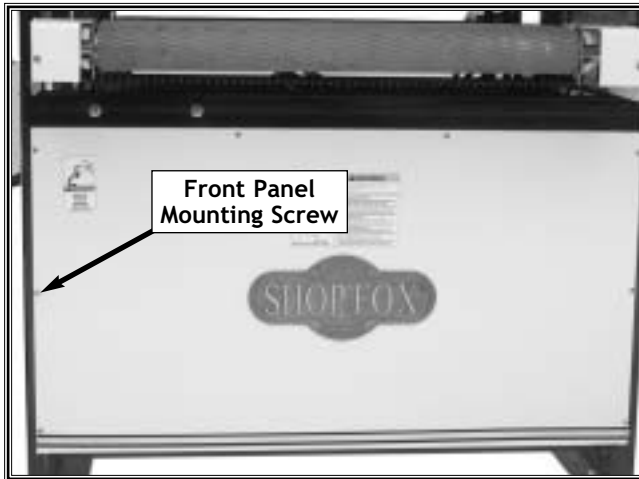

Figure 36. Front panel and mounting screws.

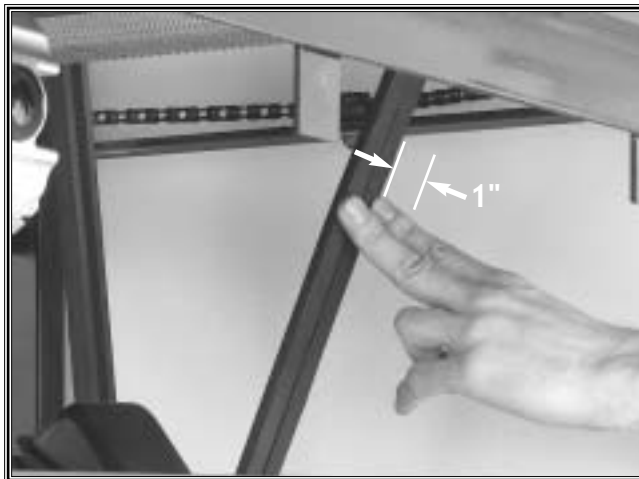
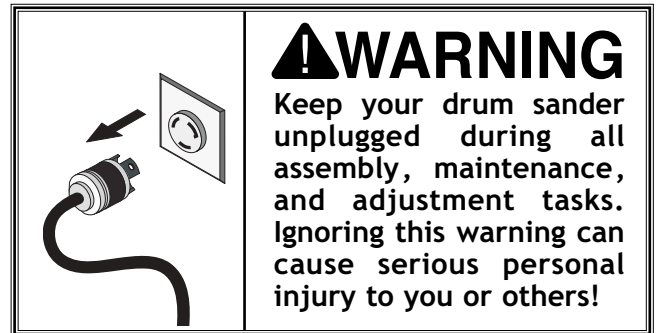

Figure 37. Belt deflection (1").

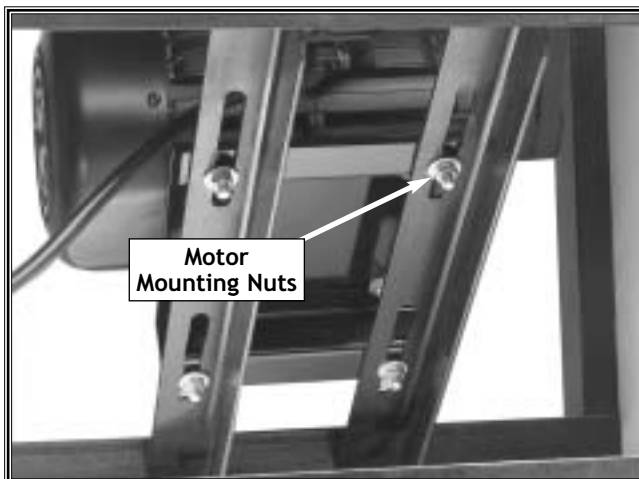

Figure 38. Motor mounting nuts.

To inspect / adjust the V-belts, do these steps:

1. Unplug the Double Drum Sander.
2. Remove eight front panel mounting screws and remove the panel. See Figure 36.
3. At the halfway point between the drum pulley and the motor pulley, push on both belts with moderate finger pressure. The looseness or deflection must be approximately 1". See Figure 37.
4. Grab the belts one at a time, twist them, and use a flashlight to inspect the inside and outside of the belt. If you see deep cracks, fraying, chunks missing, or the belt is brittle and glazed; replace both belts.
5. Loosen the motor mounting nuts, and slide the motor on the mounting plate to adjust the belt. See Figure 38.
6. Tighten the motor mounting nuts, recheck and readjust the belts as necessary.
7. Reinstall the front panel.

Conveyor Belt

For this adjustment, you will adjust the feed conveyor belt hanging gap and the tracking, so the conveyor runs in the center of the table and the drive roller does not slip at maximum sanding load. See **Figure 39**.

NOTICE

ONLY make adjustments to the infeed roller side so the drive-chain tension is not affected.

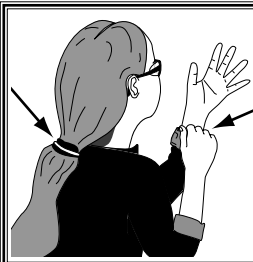

WARNING

Make sure loose clothing and long hair is secured and kept away from all moving parts.

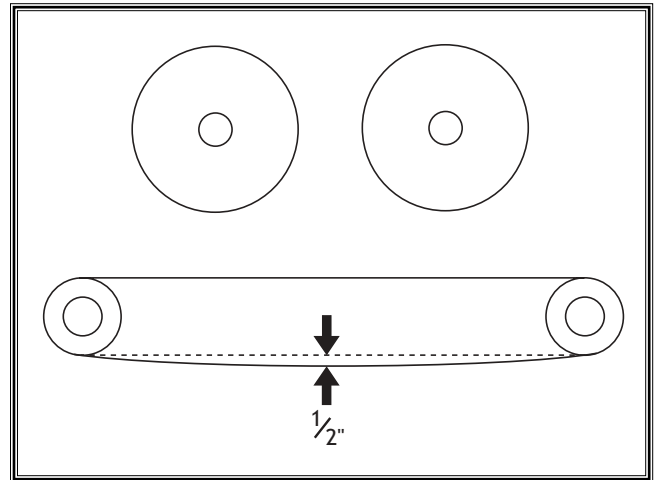

Figure 39. Conveyor belt hanging gap.

To adjust the feed conveyor belt tension and tracking, do these steps:

1. Remove the screws from the feed conveyor safety covers and open the covers. See **Figure 40**.
2. Locate the conveyor roller adjustment bolts at the infeed roller. See **Figure 41**.
 - If the feed conveyor belt is loose, turn both conveyor roller adjustment bolts counter-clockwise the same amount until the belt hangs with a $\frac{1}{2}$ " gap.
 - If the feed conveyor belt tracks to the right, start the conveyor and slightly turn the right-side conveyor roller adjustment bolt counter-clockwise.
 - If the feed conveyor belt tracks to the left, start the conveyor and slightly turn the left-side conveyor roller adjustment bolt counter-clockwise.
3. Close the safety covers and run the feed conveyor for 15 minutes at the fastest setting to make sure the belt tracks in the center of the table.
4. Repeat **Steps 2 and 3** until the belt tracks in the center of the table.
5. Turn the feed conveyor **OFF** and install the safety cover screws.



Figure 40. Infeed-conveyor safety covers.

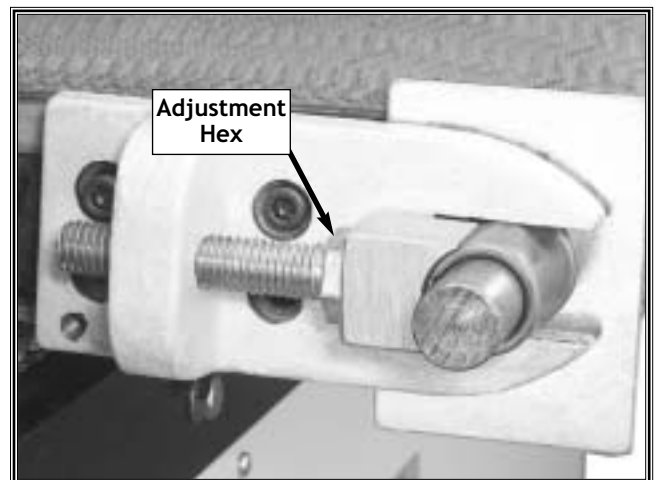

Figure 41. Conveyor roller adjustment bolts.

OPERATIONS

Overview

The Model W1678 26" Double Drum Sander accepts stock up to 4½" thick by 26" wide, and is capable of completing rough and finish sanding in one pass.

The feed conveyor pushes the workpiece into the infeed side of the sander and under the first pressure roller, which holds the workpiece firmly against the conveyor belt. The front sanding drum sands the workpiece with a coarse-grit sandpaper first. Then the workpiece is pushed under the second pressure roller and under the rear sanding drum, which sands the final surface with a finer-grit sandpaper, and then travels out of the sander. During sanding, a dust collector removes sanding dust through the two dust ports.

Control Panel

The control panel enables you to turn the conveyor *ON/OFF*, control the workpiece feed rate, turn the sanding drums *ON/OFF*, and monitor the sanding load applied by observing the load meter on the control panel. The panel controls are described in detail below. See **Figure 42** for control locations.

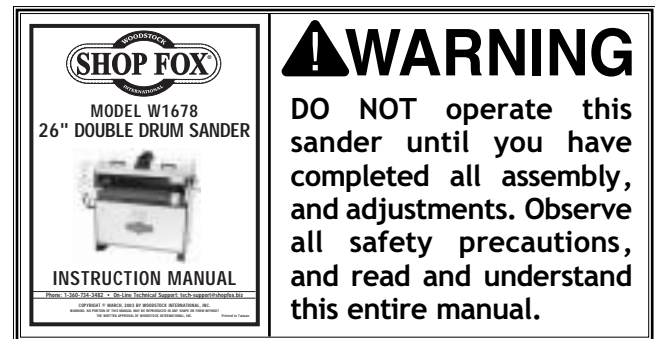

Figure 42. Control Panel.

The control panel offers these controls:

- **Sanding Load Meter:** Allows you to observe the amperage draw, which indicates the sanding load on the sander so you don't overload the motor (25 amps is the maximum safe load limit).

NOTE: the load applied on the sander is a balance between conveyor feed rate, sanding drum pressure on the workpiece, grit of sandpaper used, and the species of wood being sanded.

- **Emergency Stop Button:** Allows you to turn the main power *ON* or *OFF* to the double drum sander, and shut down the machine in an emergency. Twist clockwise and pull to turn *ON*, and push to turn the sander *OFF*.
- **Conveyor Speed Control Dial:** Allows you to adjust the speed at which the feed conveyor pushes the workpiece into the sander from 0-20 FPM.
- **Sanding Drum Motor *ON* and *OFF* Buttons:** Allows you to turn the sanding drums *ON* or *OFF* independently of the conveyor.
- **Conveyor Motor *ON* and *OFF* Buttons:** Allows you to turn the conveyor belt *ON* or *OFF* independently of the sanding drums.

Basic Sanding

The normal sanding depth for most workpieces is $\frac{1}{64}$ ". This depth can be achieved by approximately a $\frac{3}{4}$ turn of the table height handwheel. For each turn of the handwheel, the conveyor table moves approximately 0.021" See **Figure 43**.

Remember, heavy cuts and/or a feed rate that is too fast can jam or burn the workpiece, instantly burn the sandpaper, slip the drive belts and give poor sanding results. See **Figures 44** and **45**.

To help prevent these conditions, make the correct depth of cut; and for wide workpieces, sand them two or three times without adjusting the table height. Also, turn the stock 180° to ensure an even cut.

TIP: When you sand dark-colored wood and then you sand light-colored wood, pass a PRO-STIK® 15" x 20" cleaning pad through the drum sander so the light-colored wood will not become stained from the previously sanded dark wood.

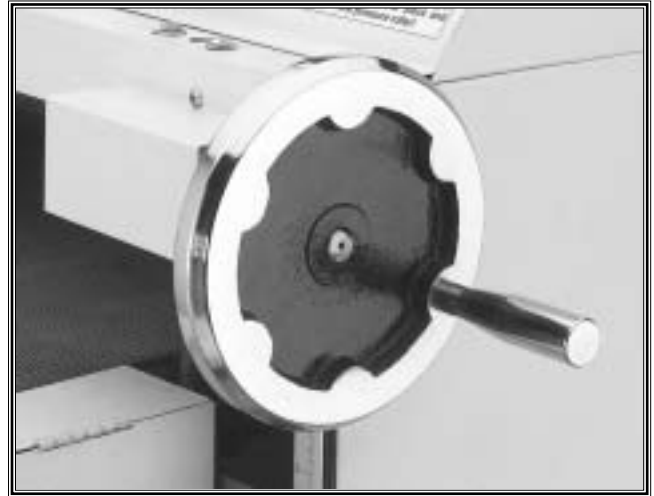

Figure 43. Table height handwheel.

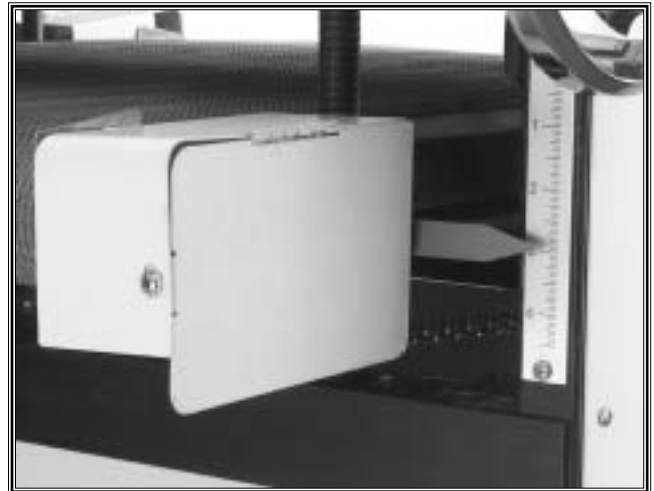

Figure 44. Depth scale indicates depth of cut.

<p>MODEL W1678 26" DOUBLE DRUM SANDER</p> <p>INSTRUCTION MANUAL</p>	<p>⚠ WARNING</p> <p>DO NOT operate this sander until you have completed all assembly and adjustments. Observe all safety precautions, and read and understand this entire manual.</p>
---	--

	<p>⚠ WARNING</p> <p>Always wear a dust mask safety glasses, and hearing protection when operating the sander. Sawdust may cause allergic reactions or respiratory problems.</p>
--	--

	<p>⚠ WARNING</p> <p>Make sure loose clothing and long hair is secured and kept away from all moving parts.</p>
--	---

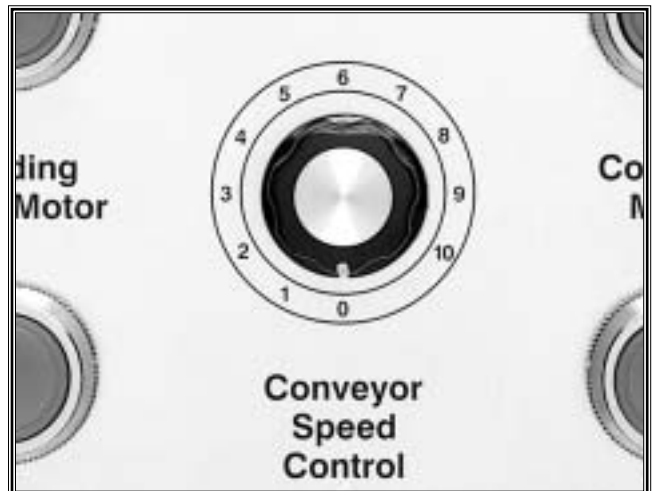

Figure 45. Conveyor speed control dial adjusts conveyor feed rate.

OPERATION



Figure 46. Main power *ON/OFF* safety switch.



Figure 47. **DO NOT** stand in the path of where the workpiece could be projected.



Figure 48. **NEVER** hold the workpiece where the conveyor and workpiece can pinch your fingers.

NOTICE

ALWAYS take a few moments to listen and observe for unusual noise and vibration after starting the Double Drum Sander.

To use the double drum sander, do these steps:

1. Twist and pull the emergency stop switch knob, and position your finger over the knob. Be ready to push the knob and shut the sander **OFF** if there is a problem. See Figure 46.
2. Push the sanding drum **ON** button and listen for any unusual noises. The sander must run smoothly with little or no vibration.
 - If unusual noise or vibration exists, push the emergency stop switch immediately and unplug the sander.
 - Troubleshoot the source of the noise or vibration, and correct the problem.
 - **ONLY** adjust the sander when it is **OFF** and unplugged.
 - **ONLY** restart the sander when you are sure the problem is corrected.
3. Start your dust collector.

⚠️ WARNING

DO NOT stand in the path where the workpiece could be projected. If you ignore this warning you could be severely injured or killed!

4. Place the workpiece on the conveyor table and turn the table height handwheel clockwise to raise the conveyor table until the stock barely touches the pressure roller. See Figure 48.
5. Push the feed motor **ON** button to start the feed conveyor.
6. See Figures 48 and 49 and feed the workpiece correctly where the conveyor cannot pinch your fingers.

NOTICE

Since various types of stock will react differently with various loads, use a process of trial-and-error to determine the best load settings and feed rate for your sanding needs.

A slower feed rate will sand the surface smoother, but risks burning the wood; a faster feed rate will remove material faster, but risks overloading the motor.

As a general rule, always start with a small load and work your way up. We recommend that you do not push your machine to its maximum load; instead, make multiple passes or install a coarser grit paper.

- Let the workpiece travel into the sander and slowly raise the conveyor table while listening for stock-to-drum contact. As soon as you hear contact, stop raising the table and watch the load meter. **DO NOT** exceed a load of 25 amps or you may damage the motor. See **Figures 49** and **50**.

- If the amperage gets higher than 25 amps, immediately lower the conveyor to reduce the load. You can also lower the conveyor FPM feed rate.

- DO NOT** stand directly in the outfeed path. Retrieve your workpiece by standing to the side of the sander at the outfeed side.

- Without raising or lowering the table, make multiple passes and check your workpiece for sanding quality and consistency.

With a pencil, you can mark a squiggly line on the workpiece and sand it to test for even sanding.

Look for uniform removal of the line. If the line is not removed uniformly, adjust the sander accordingly.



Figure 49. ALWAYS stand out of the way of where the workpiece could be projected, and keep fingers away from the underside of the workpiece.

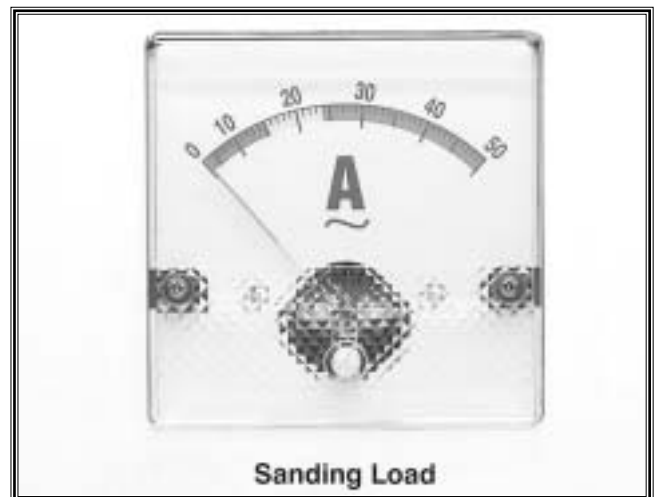

Figure 50. Load meter.

Troubleshooting

Use this troubleshooting chart to correct potential W1678 Double Drum Sander problems.

SYMPTOM	POSSIBLE REASON	HOW TO REMEDY
The sanding drums will not start.	The main power emergency stop button is pushed in, or it is faulty.	Twist and pull the main power emergency stop button, or test and replace the switch. NEVER attempt to repair safety switches, ONLY replace them with new ones.
	The power supply is insufficient or the circuit breaker or fuse is tripped.	<ol style="list-style-type: none"> 1. Repair power supply. 2. Close circuit breaker / replace the fuse. 3. Reduce sanding load to 25 amps max.
	A wire or plug is loose or broken.	<ol style="list-style-type: none"> 1. Replace all bad wiring and plugs. 2. Tighten all loose connections.
	The amperage dial is set too low.	Unplug the sander, open the main power panel, and adjust the amperage dial on the main power magnetic switch to 25 amps.
	The thermal protection circuit breaker is tripped.	<ol style="list-style-type: none"> 1. Unplug sander, open main power panel, and push the reset button. 2. Reduce sanding load to 25 amps max.
	The main power magnetic switch is faulty.	Replace the main power magnetic switch.
	Either the ON or OFF switch is shorted open. The drum-drive motor is faulty.	Replace the push-button switch. Replace or repair the drum-drive motor.
The feed conveyor will not start, or it operates incorrectly.	The main power emergency stop button is pulled out, or it is faulty.	Twist and pull the main power emergency stop button, or test and replace the switch. NEVER attempt to repair safety switches, ONLY replace them with new.
	The power supply is insufficient or the circuit breaker or fuse is tripped.	<ol style="list-style-type: none"> 1. Repair power supply. 2. Close circuit breaker / replace the fuse. 3. Reduce sanding load to 25 amps max.
	A wire or plug is loose or broken.	<ol style="list-style-type: none"> 1. Replace all bad wiring and plugs. 2. Tighten all loose connections.
	The conveyor feed speed switch is faulty.	Replace the conveyor feed speed switch.
	Either the ON or OFF switch is shorted open.	Replace the push-button switch.
	The feed motor magnetic switch is faulty.	Replace the feed motor magnetic switch.
	The feed motor brushes are worn. The conveyor feed speed circuit board is faulty. The feed motor is faulty.	Replace both feed motor brushes. Replace or repair the conveyor feed speed circuit board. Replace or repair the feed motor.
The drum sander wobbles or vibrates.	The mobile base, stand, or platform is loose or unstable.	Make sure all fasteners are tight; the sander is operating on a sturdy stand and flat floor.
	The motor or other components are loose, misaligned, or out of adjustment.	Make sure all fasteners and sander parts are tight or correctly adjusted.

(Continued Next Page)

Troubleshooting

(Continued)

SYMPTOM	POSSIBLE REASON	HOW TO REMEDY
The feed conveyor belt stops or chatters.	The conveyor belt tension is incorrect. The conveyor belt tracking is incorrect.	Adjust the conveyor belt tension. Adjust the conveyor belt tracking.
The sanded surface is glazed and shiny.	The sandpaper is worn out. The drums are only applying light pressure against the sanded surface.	Replace the sandpaper. Increase the sanding pressure on the workpiece surface.
Long grooves or high spots on sanded surface.	The sandpaper is damaged or uneven-bald wear in certain areas. The sandpaper is unevenly crushed into the hook-and-loop wrapping on the drums.	Replace the sandpaper. Remove and rewrap the sandpaper on the drums.
The wood slips on the feed conveyor belt.	The feed conveyor belt is slippery with sawdust or the surface is worn. Too much material is being removed in one pass.	Clean or replace the feed conveyor belt. Reduce the sanding load, and adjust the drums and pressure rollers.
The left and right edges on wood are rounded.	The drums are applying too much sanding force on the workpiece and the free edges of the sandpaper are rolling over the edges.	Reduce the force the drums are applying on the workpiece surface.
The wood thickness is uneven from side-to-side.	The drums are not square to the table. The sandpaper is worn or clogged unevenly from side-to-side.	Adjust the drums and pressure rollers. Clean or replace the sandpaper.
Snipe is evident on the ends of the wood.	Lack of outfeed or infeed support is causing the snipe. The drum height and the pressure roller spring tension are incorrect.	Use roller tables and support the infeed and outfeed of the workpiece. Adjust the drums and pressure rollers.
The sandpaper clogs too quickly.	The sandpaper grit is too fine or is worn out. Too much wood is being removed at once. The wood is wet, oily, or dirty. The dust collection system is insufficient.	Replace the sandpaper. Reduce the load on the sanding drums. Sand only dry and clean wood. Service the dust collection system or increase the duct collector system efficiently.
The sandpaper tears.	The drums are not sanding parallel to direction of conveyor belt feed. Drums are not square with the table. Sandpaper edges have overlapped or tape has slipped. Too much wood is being removed at once.	Adjust the drums and pressure rollers. Adjust the drums and pressure rollers. Wrap sandpaper on drums correctly and use a heavy-duty tape. Reduce the load on the sanding drums.

MAINTENANCE

General

Regular maintenance on your Model W1678 helps ensure optimum performance. Inspect your machine each time you use it for the following conditions. Adjust, repair, or replace parts when worn.

1. Inspect for loose bolts and panels.
2. Make sure the work area is clean, and remove any tools or rags from the machine.
3. Replace worn electrical parts like the emergency stop switch, **ON** and **OFF** push buttons, and damaged cords and plugs.
4. Replace damaged sandpaper, motor V-belts, or conveyor drive chains and sprockets.
5. Correct any other condition that could hamper the safe operation of this machine.
6. Routinely clean the sandpaper with a PRO-STIK® 15" x 20" cleaning pad shown in **Figure 51**.



Figure 51. PRO-STIK® 15" x 20" cleaning pad.

Sanding Belts

As sanding drums are used, the sandpaper can quickly become "loaded" with sawdust. If not removed, this sawdust may harden on the abrasive surface and can glaze instead of sand the wood, thus, rendering the sandpaper useless.

To avoid this condition, routinely clean the sandpaper with a rubber gum abrasive cleaner such as the D3003 PRO-STIK® 15" x 20" cleaning pad shown in **Figure 51**. to extend the life of the sandpaper.

Discard all worn sandpaper because the grit will fall off causing deep gouges in the workpiece. Also the glue used to hold the grit to the paper can rub off onto the workpiece burning the workpiece. Contrary to some beliefs, worn abrasive belts are not the equivalent to the next finer grit abrasive.

REPLACEMENT SANDPAPER	
GRIT	PART #
60	D3162
100	D3163
150	D3164

There are many types of sandpaper you can use. Aluminum Oxide is excellent for general wood shop use. To the right is a chart that groups abrasives into different classes, and shows which grits fall into each class.

GRIT RANGE	TYPE
60	Coarse
80-100	Medium
120-180	Fine
220	Very Fine

The Model W1678 allows you to use two different grit sandpapers at once. The first drum is fitted with a coarser grit than the second. Usually this translates into combinations of successive group types. A common selection for a workpiece that is planed before it is sanded, is the 100/150 grit combination.

Overall, the general rule of thumb is to sand a workpiece with sandpaper that uses progressively higher grit numbers, with no one grit increase of more than 50.

Ultimately, the type of wood you use and your stage of finish will determine the best grit types to install on your sander.

Lubrication

The four drum bearings in the bearing blocks need to be lubricated every 20 hours of operation. However, all other bearings used on this machine are shielded and permanently lubricated. Simply leave them alone until they need to be replaced. **DO NOT** lubricate them, as this will only attract dust and cause possible premature bearing failure.

DO NOT apply grease on any exposed areas on the sander like the feed conveyor chain, sprockets, and the table lead screws. If you do, sanding dust and abrasives will collect on these parts and create a gummy mixture that can hamper proper movement of components and increase wear. Use a light machine oil and a dry graphite lubricant.

To lubricate the sander, do these steps:

1. Unplug the double drum sander.
2. Clean the sander as outlined in **General Cleaning** procedures on **Page 34**.
3. Open the dust hood to gain access to the four drum-bearing-housing grease zerk. See **Figure 57**.
4. Remove the grease zerk cap from the bearing block housing, wipe all contamination off of the zerk, and squirt two pumps of high-quality lithium-base grease into the bearing. **DO NOT** over-grease the bearing.
5. Coat the exposed areas of the table lead screws with dry powdered graphite.
6. Coat the feed conveyor chain and sprockets with a light machine oil, and use a rag to wipe-off the residual oil. See **Figure 52**.
7. Put three drops of the machine oil in the handwheel bushing oil port and a couple of dabs of lithium-base grease on the handwheel gears. See **Figure 53**.
8. Wipe off any loose grease and replace the dust cap.
9. Repeat **Steps 1** through **6** for the three remaining drum bearings.
10. Close the dust hood and close the latches.

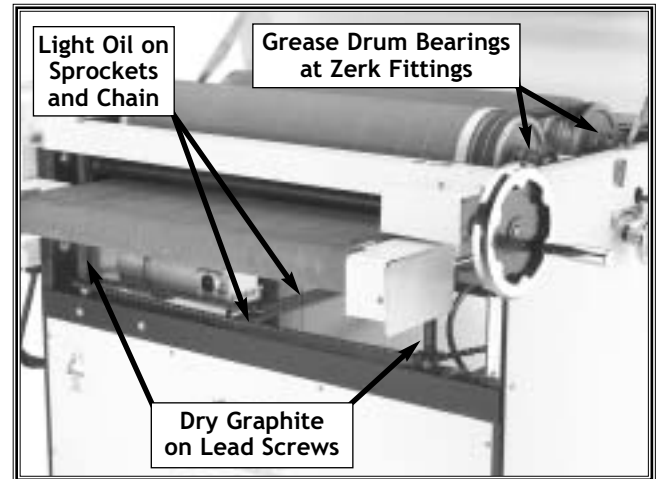

Figure 52. Drum bearings, table head screws, feed conveyor chain and sprockets.

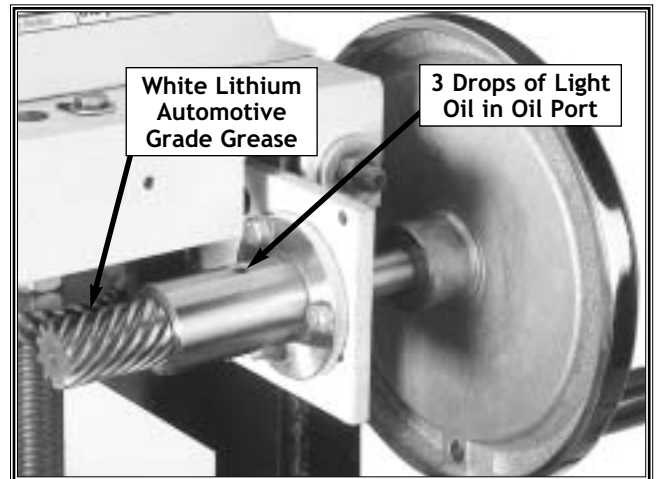

Figure 53. Handwheel bushing and gears.

If any part of the sander becomes difficult to operate, it is most likely caused by an accumulation of sawdust. Immediately troubleshoot the area and remove any sawdust. Or contact Woodstock International, Inc. Service and Support at 1-360-734-3482 or send e-mail to: tech-support@shopfox.biz.

Brush Replacement

After long periods of heavy sander use, it may be necessary to replace the conveyor motor carbon brushes.

To replace the carbon brushes, do these steps:

1. Unplug the double drum sander!
2. Raise the table to the highest position.
3. Use a flat-head screwdriver and remove the brush cover. See **Figure 54**.
4. Carefully slide out the spring and carbon brush. See **Figure 55**.
5. Insert the new carbon brush exactly like the old one was installed.
6. Replace the brush cover.
7. Repeat **Steps 1** through **6** for the other motor brush on the other side of the motor.

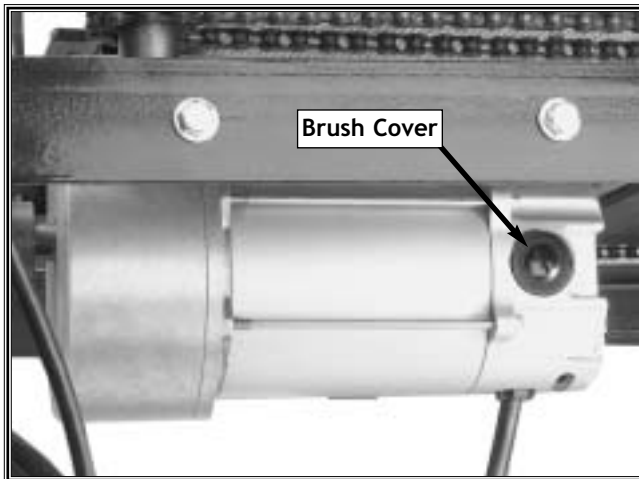

Figure 54. Conveyor motor brush cover.



Figure 55. Carbon brush and spring.

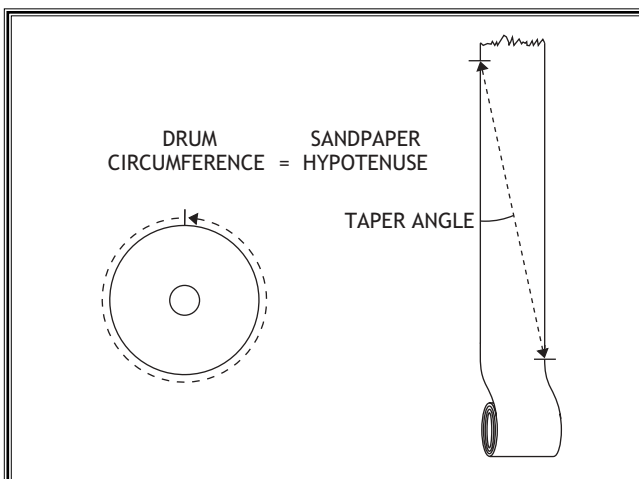

Figure 56. Finding sandpaper taper angle.

Sandpaper Replacement

The Model W1678 Double Drum Sander is designed for rolls of 3" wide hook-and-loop sandpaper.

To change the sandpaper, do these steps:

1. Unplug the double drum sander!
2. Open the dust hood to expose the drums.
3. Observe the direction that the sandpaper is wrapped around the drum, and unwind the old sandpaper one drum at a time.
4. Use the old sandpaper as a pattern to cut out the new sandpaper, or measure and cut the sandpaper taper yourself. See **Figure 56**.
5. Tightly wrap the sanding drum with the new sandpaper and keep the gaps to a minimum.
6. Apply two complete passes of $\frac{3}{4}$ " reinforced strapping tape at both drum ends, making sure that the second layer is directly on top of the first.
7. Replace the sandpaper on the other drum, and close and latch the dust hood.

Bearing Replacement

The Model W1678 26" Double Drum Sander is designed for many years of reliable service. But after long periods of heavy sander use, it may be necessary to replace the drum bearings. Always replace both bearings on the same drum.

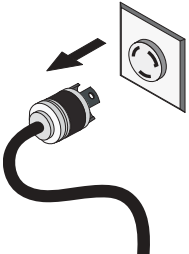

!WARNING
 Keep your drum sander unplugged during all assembly, maintenance, and adjustment tasks. Ignoring this warning can cause serious personal injury to you or others!

To replace the drum bearings, do these steps:

1. Unplug the double drum sander!
2. Open the dust hood, and remove the mounting nuts, the washers and the set screws. See Figure 57.

NOTICE

DO NOT hammer on the bearing or housing as you **WILL** damage these precision parts.

3. Lift the drum and slide the bearing block and bearing from the drum shaft.
4. Clean and inspect the drum shaft for cracks, burrs, wear, and other damage; replace/repair as required.
5. Use a screwdriver to pry and rotate the bearing so it is horizontal to the bearing-block mounting flanges. See Figure 58.
6. Slide the bearing out of the bearing block. See Figure 59.

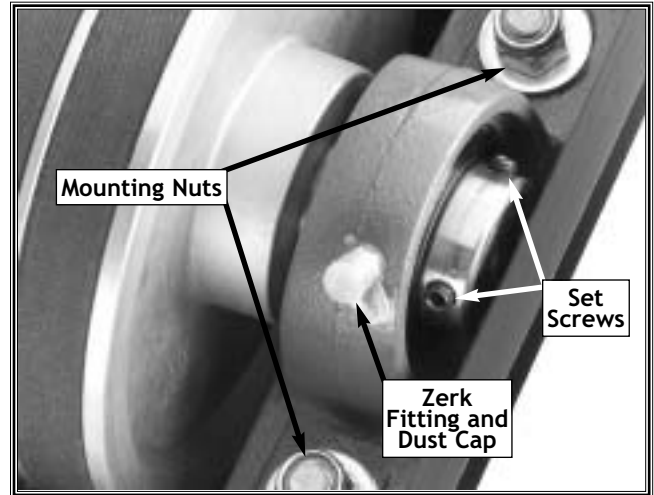

Figure 57. Mounting nuts, washers, and set screws.



Figure 58. Bearing positioning for removal.

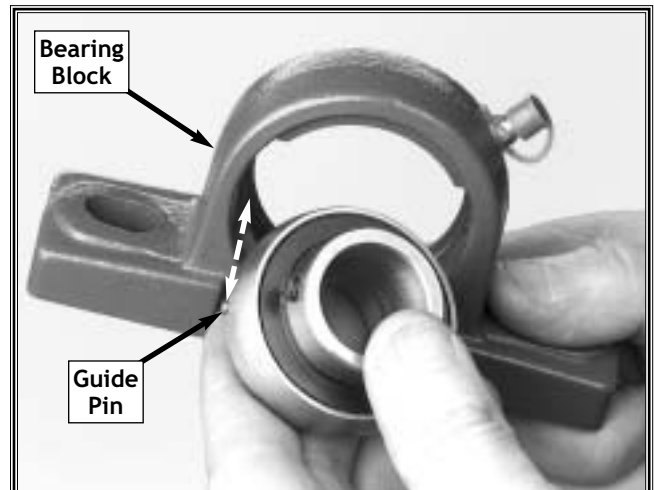

Figure 59. Removal and installation bearing positioning.

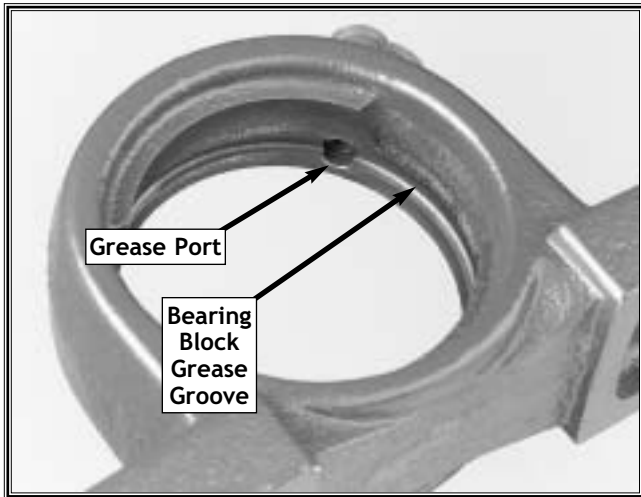

Figure 60. Bearing-block grease grove and grease port.

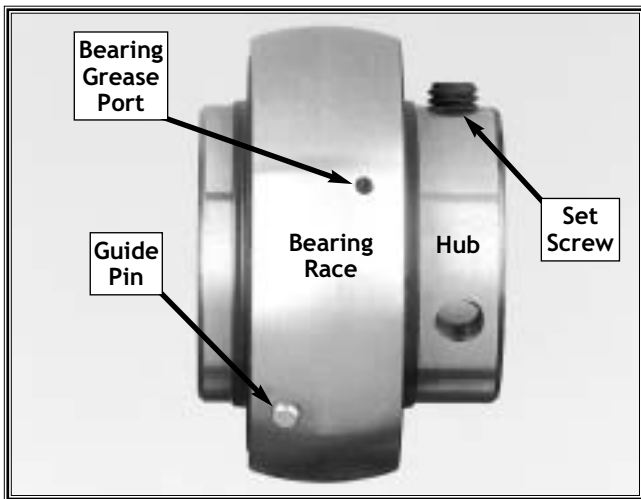

Figure 61. Key bearing parts.

7. Remove any metal or abrasives trapped in the bearing grease groove and grease port, or contaminants will be pumped into the new bearing when you lubricate it, causing bearing failure. **Figure 60.**
8. Clean and inspect the bearing-block for cracks, burrs, wear, and other damage; replace/repair as required.

The “bearing race” should rotate inside of the “bearing block” smoothly. If the race is loose or wobbles inside of the bearing block, replace the bearing block. See **Figure 61.**

NOTICE

Make sure the bearing grease hole in the bearing lines up with the grease groove in the bearing block and that no obstructions prevent bearing lubrication.

9. Insert the new bearing into the bearing-block so when the bearing block is installed in the sander, the grease zerk is facing forward and the set screws and hub are on the right-side of the bearing housing. See **Figures 57 and 61.**
10. Slide (**DO NOT** hammer) the bearing block and bearing onto the drum shaft.
11. Lower the drum and bearing-block onto the mounting studs, and install the flat washers and the nuts. Tighten the nuts in an alternating pattern until snug.
12. Install and tighten the set screws.
13. Wipe the zerk fitting clean, and lubricate the bearing with just enough grease to slightly seep from the dust seal and wipe clean (these bearings are not pre-lubricated). **DO NOT** over-grease.
14. Repeat **Steps 3** through **13** on all other bearings that need replacement. Always replace both bearings on the same drum.
15. Adjust the **Drums and Pressure Rollers** as outlined in the **Adjustments** section, on **Page 14.**

General Cleaning

DO NOT use a mineral-spirit solvent or chlorine-based cleaner to clean a painted or plastic surface, or the rubber conveyor belt. If you do, you will permanently ruin the surface.

To clean dust from the sander, do these steps:

1. **Unplug the double drum sander.**
2. Put on your safety glasses and dust mask.
3. Turn the dust collector **ON**, and use a hand brush and vacuum or compressed air to carefully blow out built up sawdust.
4. With the dust collector **OFF**, dampen a cloth with warm water and mild dish soap, and wipe dusty surfaces clean.

To clean grease from the sander, do these steps:

1. **Unplug the double drum sander.**
2. Use mineral spirits to remove the excess grease on the metal parts, and follow all manufacturer's safety warnings.
3. Coat the cleaned metal surface with an application of SLIP-IT®.

For long term storage you may want to consider products like Boeshield® T-9.

4. Lubricate as outlined in the Lubrication procedures on **Page 30**.

W1678 26" Double Drum Sander

Drive System Wiring Diagram

⚠️ WARNING

Seek assistance from a qualified electrician if you do not understand the wiring diagram in this manual. Always follow the applicable electrical codes and standards. Otherwise serious personal injury or death may occur!

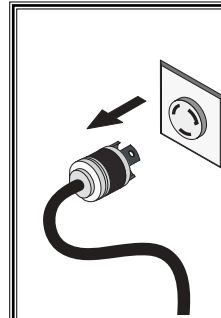

⚠️ WARNING

Keep your machine unplugged during all service and wiring procedures. Otherwise serious personal injury may occur!

NOTE: The motor power-supply wires in the POWER JUNCTION BOX besides the green wire are interchangeable. Therefore, motor wire colors are not specified on this diagram.

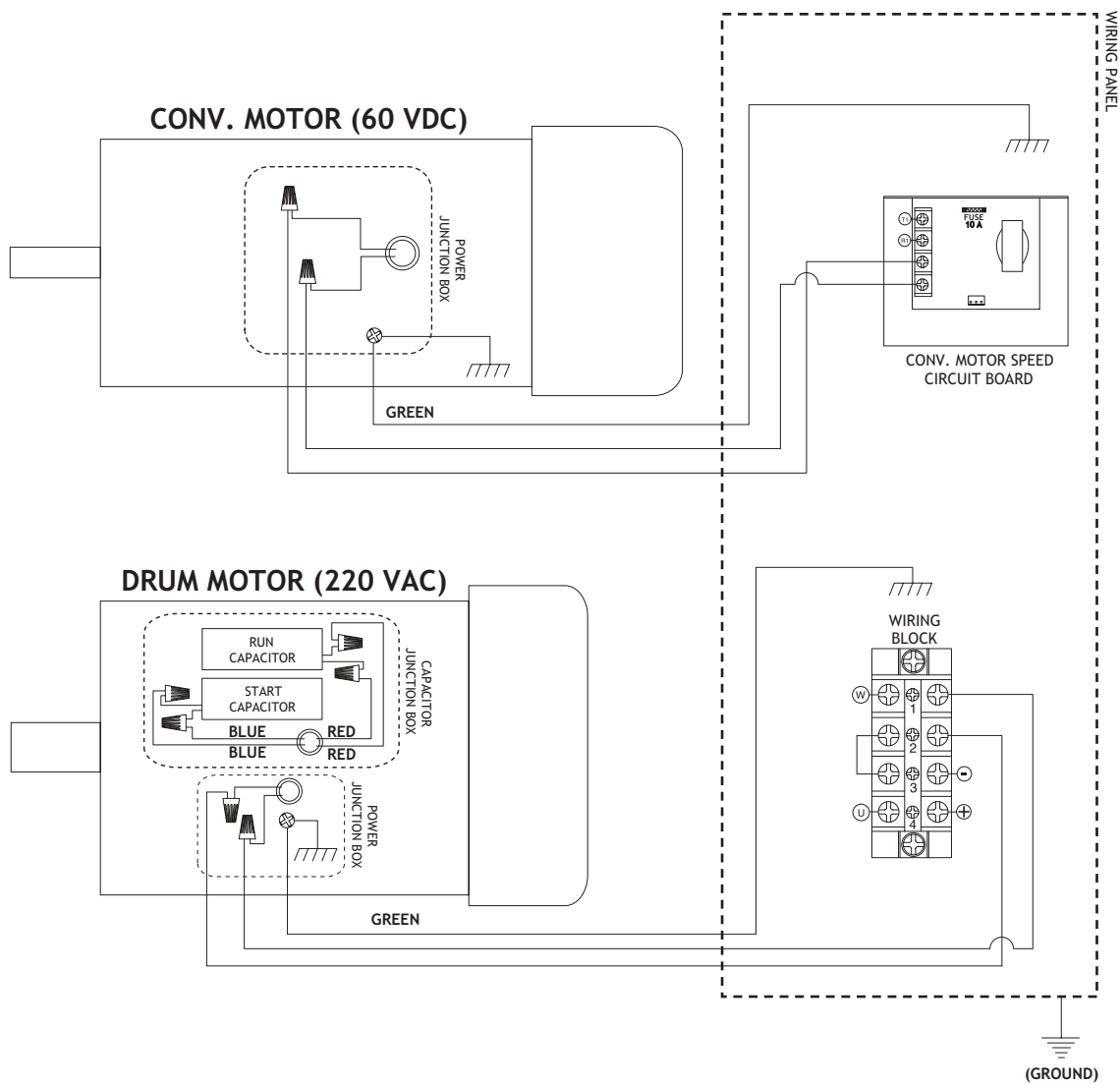

W1678 26" Double Drum Sander Control System Wiring Diagram

CONTROL BOX

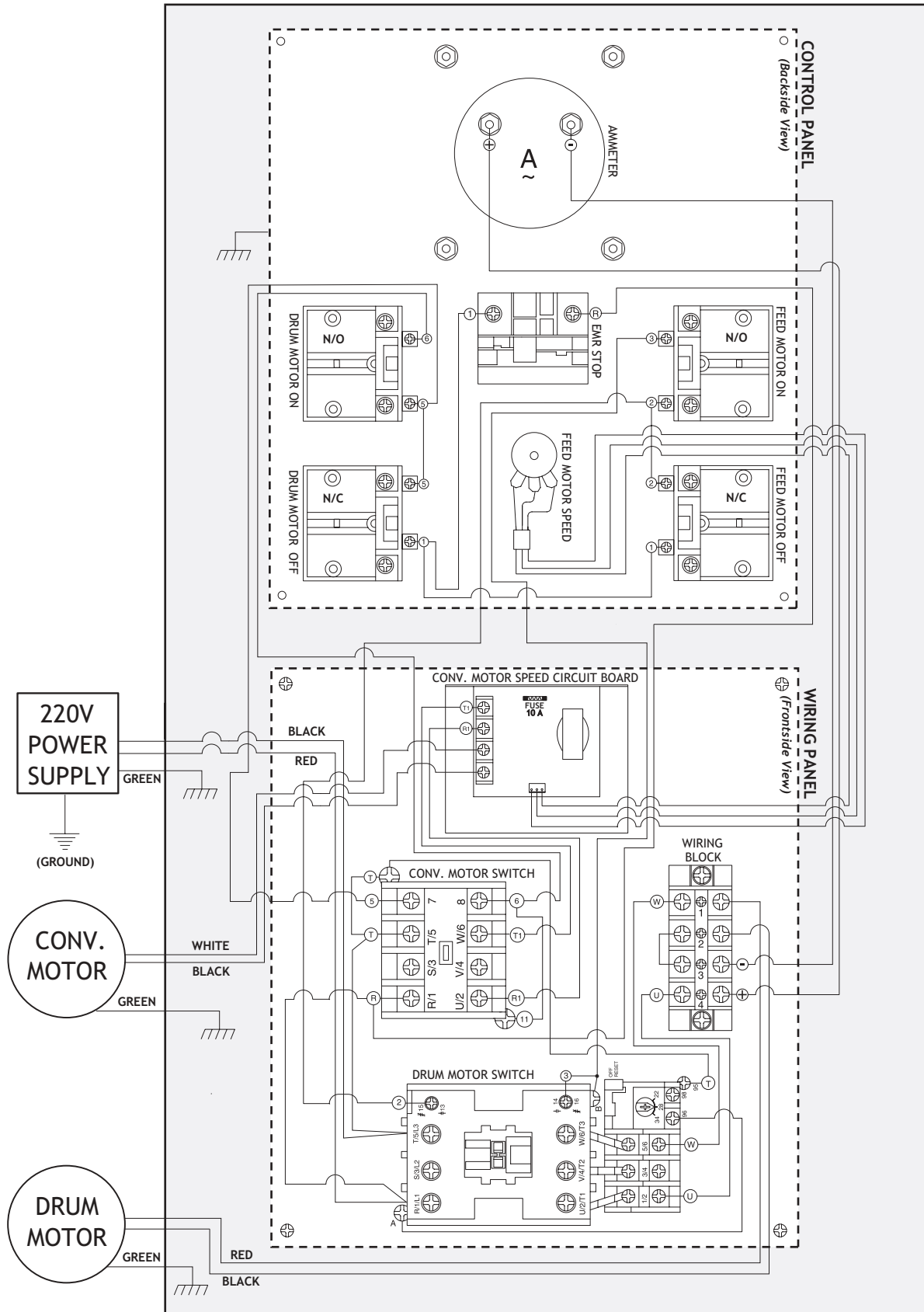

CLOSURE

The following pages contain parts diagrams/lists and a warranty card for your **SHOP FOX®** Model W1678.

If you need parts or help in assembling your machine, or if you need more operational information, we encourage you to call our Service Department. Our trained service technicians will be glad to help you.

If you have comments dealing specifically with this manual, please write to us using the address in the General Information. The specifications, drawings, and photographs illustrated in this manual represent the Model W1678 as supplied when the manual was prepared. However, due to Woodstock International, Inc.'s policy of continuous improvement, changes may be made at any time with no obligation on the part of Woodstock International, Inc. Whenever possible, though, we send manual updates to all owners of a particular tool or machine that have registered their purchase with our warranty card. Should you receive one, add the new information to this manual and keep it for reference.

We have included some important safety measures that are essential to the operation of the machine. While most safety measures are generally universal, we remind you that each workshop is different and safety rules should be considered as they apply to your specific situation.

We recommend you keep this manual for complete information regarding Woodstock International, Inc.'s warranty and return policy. Should a problem arise, we recommend that you keep your proof of purchase with your manual. If you need additional technical information relating to this machine, or if you need general assistance or replacement parts, please contact the Service Department at 1-360-734-3482 or e-mail: tech-support@shopfox.biz.

Additional information sources are necessary to realize the full potential of this machine. Trade journals, woodworking magazines, and your local library are good places to start.

The Model W1678 is specifically designed for sanding operations. **DO NOT MODIFY AND/OR USE THIS MACHINE FOR ANY OTHER PURPOSE. MODIFICATIONS OR IMPROPER USE OF THIS TOOL WILL VOID THE WARRANTY.** If you are confused about any aspect of this machine, **DO NOT** use it until all your questions have been answered.

 WARNING		
<p>Operating this equipment has the potential for flying debris to cause eye injury. Always wear safety glasses or goggles when operating equipment. Everyday glasses or reading glasses only have impact resistant lenses, they are not safety glasses. Be certain the safety glasses you wear meet the appropriate standards of the American National Standards Institute (ANSI).</p>		
		

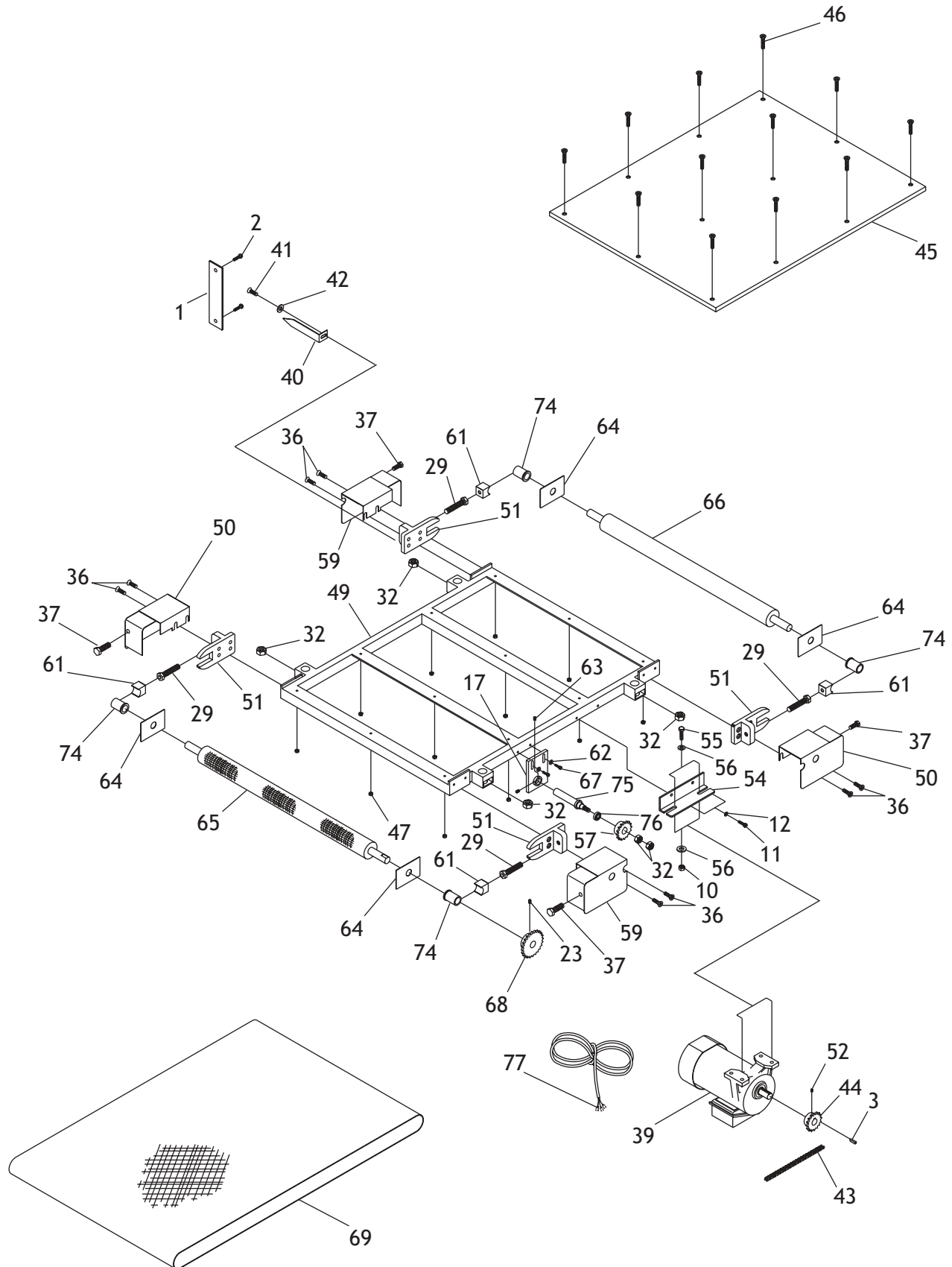

REF	PART #	DESCRIPTION
1	X1678001	SCALE
2	XPHTEK7	SELF TAP SCREW #8 X 3/8"
3	XPK34M	KEY 5 X 5 X 20MM
10	XPN02	HEX NUT 5/16"-18
11	XPSB05	CAP SCREW 1/4"-20 X 3/4"
12	XPW06	FLAT WASHER 1/4"
17	X1678017	ADJUSTMENT PLATE
23	XPSS08	SET SCREW 5/16"-18 X 1/2"
29	X1678029	SPECIAL BOLT
32	XPN03	HEX NUT 3/4"-16
36	XPSB05	CAP SCREW 1/4"-20 X 3/4"
37	XPS06	PHLP HD SCR #10-24 X 3/8"
39	X1678039	1/3 HP FEED BELT MOTOR
40	X1678040	POINTER
41	XPS07	PHLP HD SCR 1/4"-20 X 3/8"
42	XPW06	FLAT WASHER 1/4"
43	X1678043	DRIVE CHAIN
44	X1678044	SPROCKET 16-TEETH
45	X1678045	TABLE
46	XPFH12	FLAT HD SCREW 1/4"-20 X 1"
47	XPLN02	LOCK NUT 1/4"-20
49	X1678049	TABLE FRAME

REF	PART #	DESCRIPTION
50	X1678050	LEFT ROLLER-END GUARD
51	X1678051	ROLLER BRACKET
52	XPSS11	SET SCREW 1/4"-20 X 1/4"
54	X1678054	MOTOR BRACKET
55	XPB12	HEX BOLT 5/16"-18 X 1-1/4"
56	XPW07	FLAT WASHER 5/16"
57	X1678057	SPROCKET 16-TEETH
59	X1678059	RIGHT ROLLER-END GUARD
61	X1678061	BUSHING SUPPORT
62	XPW06	FLAT WASHER 1/4"
63	XPSS05	SET SCREW 5/16"-18 X 1/4"
64	X1678064	PLATE
65	X1678065A	DRIVE ROLLER
66	X1678065B	IDLER ROLLER
67	XPB05	HEX BOLT 1/4"-20 X 3/4"
68	X1678068	SPROCKET 24-TEETH
69	X1678069	CONVEYOR BELT
74	X1678074	BUSHING
75	X1678075	SPROCKET SHAFT
76	XP6201	BALL BEARING 6201
77	X1678077	VS MOTOR CORD 5' 14-GA

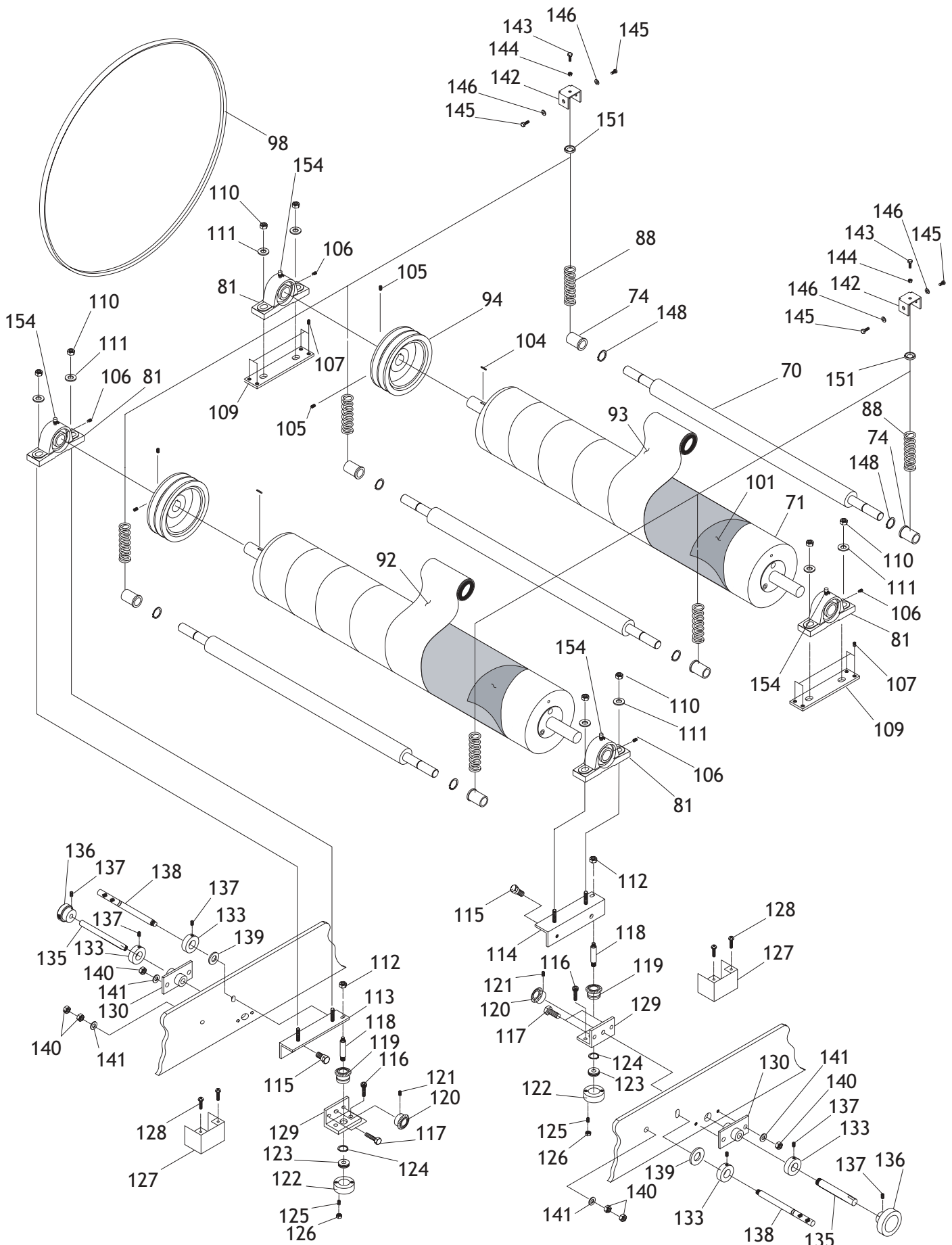

REF	PART #	DESCRIPTION
70	X1678070	PRESSURE ROLLER
71	X1678071	SANDING DRUM
74	X1678174	BUSHING
81	X1678081	BEARING BLOCK
88	X1678088	COMPRESSION SPRING
92	X1678092	FINE SNDPPR 3" X 195"
93	X1678093	COARSE SNDPPR 3" X 195"
94	X1678094	DRUM PULLEY
98	X1678098	V-BELT B-67
101	X167892A	HOOK-AND-LOOP DRUM COVER
104	XPK10	KEY 1/4" X 1/4" X 1-1/4"
105	XPSS09	SET SCREW 3/8"-16 X 1/2"
106	XPSS02M	SET SCREW M6-1.0 X 6
107	XPSS08	SET SCREW 5/16"-18 X 1/2"
109	X1678109	ADJUST PLATE
110	XPLN01	LOCK NUT 3/8"-16
111	XPW02	FLAT WASHER 3/8"
112	XPLN02	LOCK NUT 1/4"-20
113	X1678113	LEFT FLANGE
114	X1678114	RIGHT FLANGE
115	X1678115	SPECIAL BOLT
116	XPSB01	CAP SCREW 1/4"-20 X 5/8"
117	XPSB12	CAP SCREW 5/16"-18 X 1-1/4"
118	X1678118	AXLE
119	X1678119	BEVEL GEAR
120	X1678120	BEVEL GEAR
121	XPSS29	SET SCREW 10-24 X 1/4"
122	X1678122	THRUST BEARING SEAT

REF	PART #	DESCRIPTION
123	X1678123	THRUST BEARING 51101
124	XPR09M	EXT RETAINING RING 20MM
125	XPSS34	SET SCREW #10-24 X 1/2"
126	XPN11	HEX NUT #10-24
127	X1678127	DUST COVER
128	XPHTEK6	SELF TAP SCREW #10 X 3/8"
129	X1678129	GEAR MOUNTING BRACKET
130	X1678130	DRIVE SHAFT BRACKET
133	X1678133	LOCK COLLAR
135	X1678135	DRIVE SHAFT
136	X1678136	MICRO-ADJUST KNOB
137	XPSS04	SET SCREW 1/4"-20 X 5/16"
138	X1678138	LOCK LEVER 5/16" X 18
139	XPW07	FLAT WASHER 5/16"
140	XPN02	HEX NUT 5/16"-18
141	XPW07	FLAT WASHER 5/16"
142	X1678142	BRACKET
143	XPB02	HEX BOLT 1/4" -20 X 5/8"
144	XPN05	HEX NUT 1/4"-20
145	XPB51	HEX BOLT 1/4"-20 X 3/8"
146	XPW06	FLAT WASHER 1/4"
148	XPR08M	EXT RETAINING RING 19MM
151	X1678151	SPRING GUIDE
154	X1678154	GREASE ZERK W/CAP
-	D3162	60-GRIT SNDPPR 3" X 50'
-	D3163	100-GRIT SNDPPR 3" X 50'
-	D3164	150-GRIT SNDPPR 3" X 50'

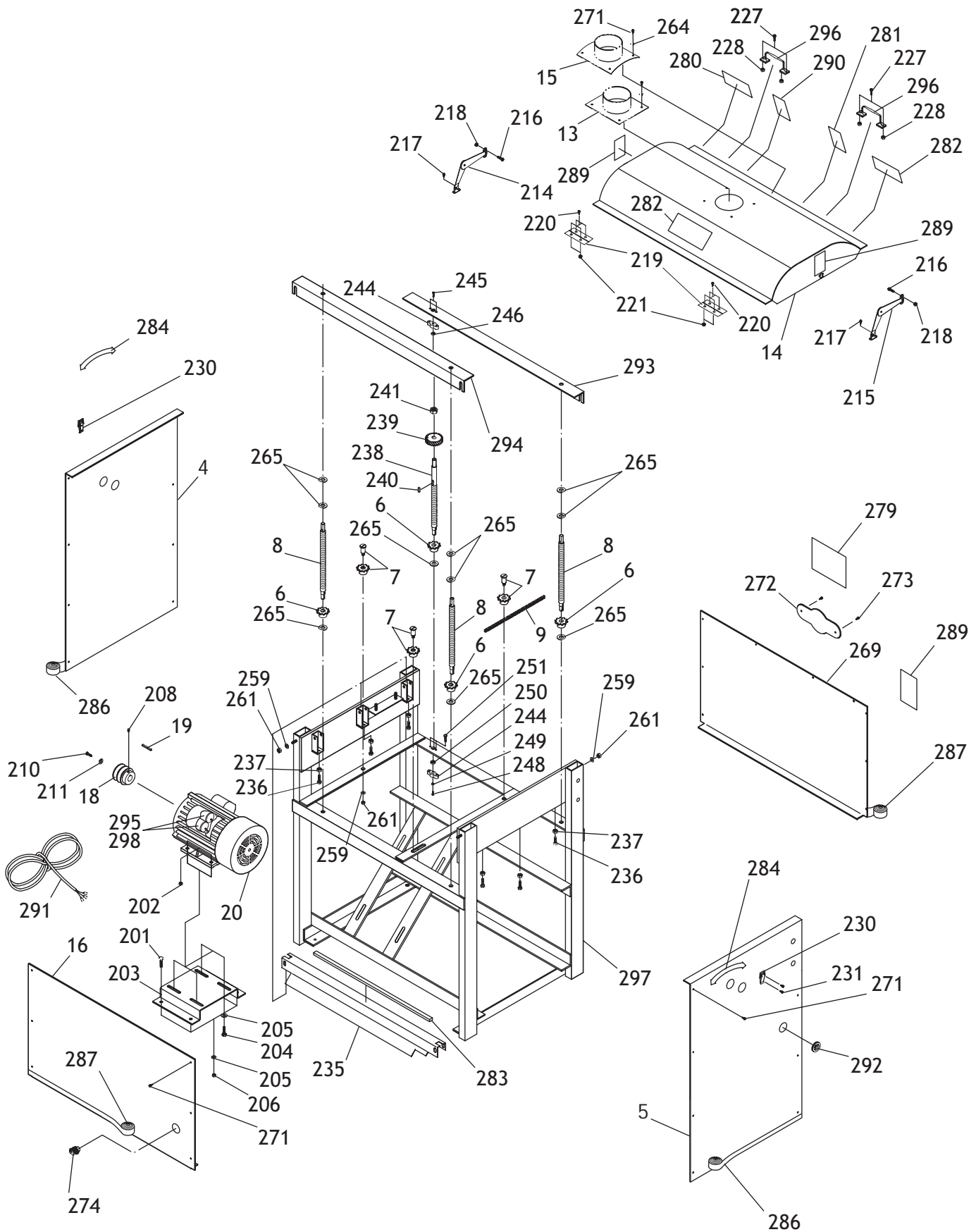

REF	PART #	DESCRIPTION
4	X1678004	SIDE PANEL
5	X1678004A	SIDE PANEL
6	X1678006	SPROCKET 10-TEETH
7	X1678007	SPROCKET W/SHAFT
8	X1678008	TABLE LEAD SCREW 3/4"-16
9	X1678009	ELEVATION CHAIN
13	X1678013	DUST PORT (FLAT BASE)
14	X1678014	HOOD
15	X1678013A	DUST PORT (CURVED BASE)
16	X1678016	REAR PANEL
18	X1678218	MOTOR PULLEY
19	XPK23M	KEY 5 X 5 X 25MM
20	X1678020	5-HP MOTOR
201	XPB18	HEX BOLT 3/8"-16 X 1"
202	XPN08	HEX NUT 3/8"-16
203	X1678203	BRACKET
204	XPB18	HEX BOLT 3/8"-16 X 1"
205	XPW02	FLAT WASHER 3/8"
206	XPN08	HEX NUT 3/8"-16
208	XPSS07	SET SCREW 1/4"-20 X 1/2"
210	XPB19M	HEX BOLT M8-1.25 X 24MM
211	XPW02	FLAT WASHER 3/8"
214	X1678214	RIGHT HOOD ARM
215	X1678215	LEFT HOOD ARM
216	XPS17M	PHLP HD SCR M4-0.7 X 6MM
217	XPHTEK7	SELF TAP SCREW #8 X 3/8"
218	XPN04M	HEX NUT M4-0.7
219	X1678219	HINGE
220	XPS38M	PHLP HD SCR M4-0.7 X 10MM
221	XPLN01M	LOCK NUT M4-0.7
227	XPSB07	CAP SCREW 5/16"-18 X 3/4"
228	XPN02	HEX NUT 5/16"-18
230	X1678230	LATCH
231	XPHTEK7	SELF TAP SCREW #8 X 3/8"
235	X1678235	DUST SCOOP
236	XPB02	HEX BOLT 1/4"-20 X 5/8"
237	XPN05	HEX NUT 1/4"-20
238	X1678238	TABLE LEAD SCREW 3/4"-16

REF	PART #	DESCRIPTION
239	X1678239	GEAR 25-TEETH
240	XPK06M	KEY 5 X 5 X 10MM
241	XPLN06	LOCK NUT 1/2"-13
244	X1678244	BEARING SEAT
245	XPB51	HEX BOLT 1/4"-20 X 5/8"
246	X1678246	BEARING TA-810
248	XPS01	PHLP HD SCR #10-24 X 1/2"
249	X1678249	SPRING WASHER 3/16"
250	X1678250	BEARING 698
251	XPB05	HEX BOLT 1/4"-20 X 3/4"
259	XPW07	FLAT WASHER 5/16"
261	XPN02	HEX NUT 5/16"-18
264	XPW18	FLAT WASHER 3/16"
265	XPW01	FLAT WASHER 1/2"
269	X1678269	FRONT PANEL
271	XPHTEK7	SELF TAP SCREW #8 X 3/8"
272	X1678272	LOGO (SHOP FOX)
273	X1678273	LOGO SCREW #4-3/8"
274	XPSW10	STRAIN RELIEF 3/4"
279	X1678279	LABEL (MACHINE DATA)
280	X1678280	LABEL (KEEP HANDS)
281	X1678281	LABEL (DUST MASK)
282	X1678282	LABEL (DO NOT STAND)
283	X1678283	ADHESIVE FOAM SRIP
284	X1678284	LABEL (DOWN/UP)
286	X1678286	LEFT/RIGHT COLOR-STRIPE
287	X1678287	FRONT/REAR COLOR STRIPE
289	X1678289	LABEL (UNPLUG SANDER)
290	X1678290	LABEL (SAFETY GLASSES)
291	X1678291	220V MTR CORD 5' 12-GA
292	X1678292	GROMMET 30MM
293	X1678293	FRONT BRACE
294	X1678294	REAR BRACE
295	X1678020-2	RUN CAPACITOR
296	X1678296	HANDLE
297	X1678297	FRAME
298	X1678020-1	START CAPACITOR

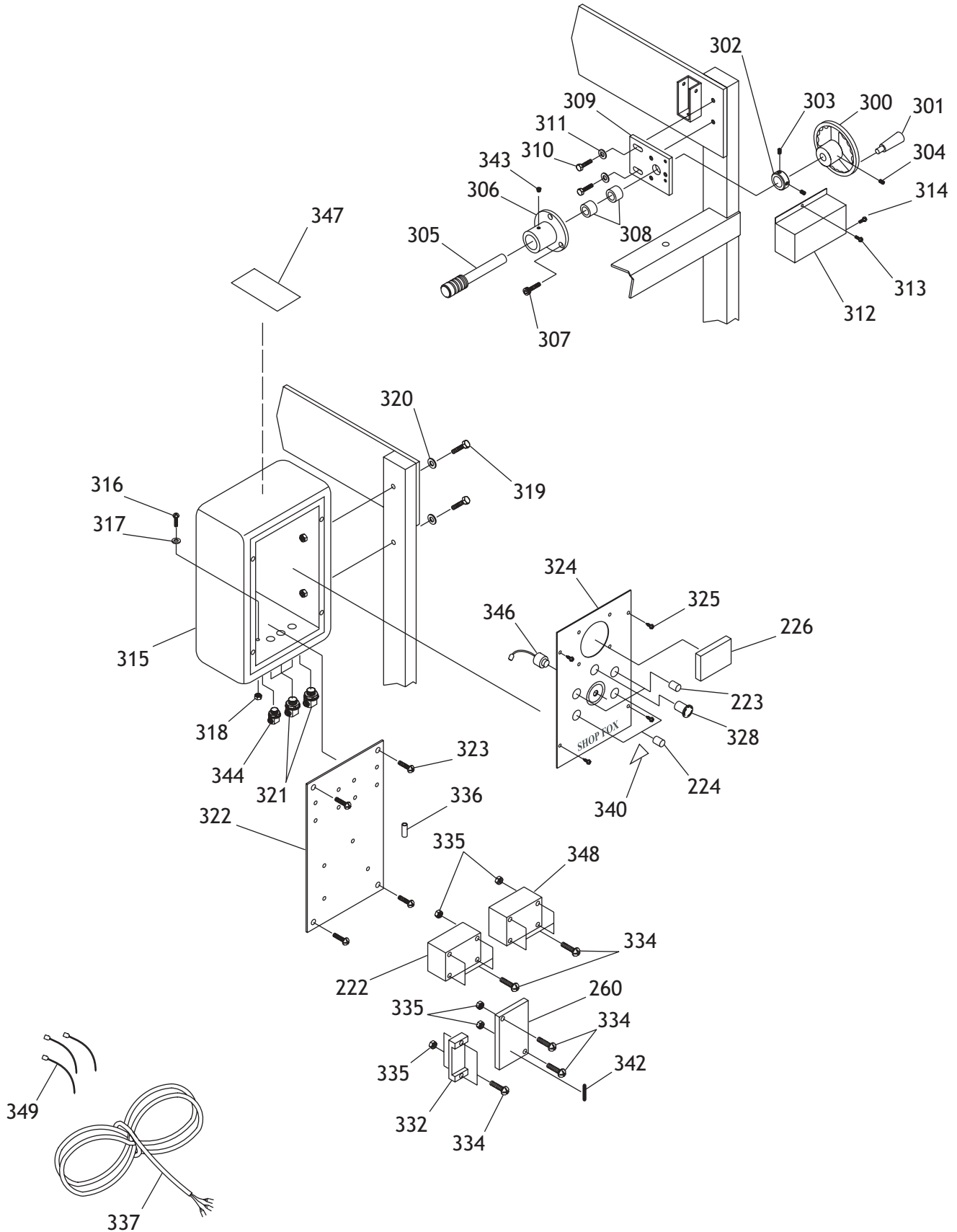

REF	PART #	DESCRIPTION
222	X1678222	MAGNETIC SWITCH
223	X1678223	ON SWITCH
224	X1678224	OFF SWITCH
226	X1678226	LOAD AMP METER
260	X1678260	VS MOTOR CIRCUIT BOARD
300	X1678300	CRANK
301	X1678301	HANDLE
302	X1678302	COLLAR
303	XPSS11	SET SCREW 1/4"-20 X 1/4"
304	XPSS08	SET SCREW 5/16"-18 X 1/2"
305	X1678303	WORM GEAR 10 TEETH
306	X1678306	SHAFT MOUNT
307	XPSB05	CAP SCREW 1/4"-20 X 3/4"
308	X1678308	BUSHING
309	X1678309	ADJUSTMENT PLATE
310	XPB18	HEX BOLT 3/8"-16 X 1"
311	XPW02	FLAT WASHER 3/8"
312	X1678312	DUST COVER
313	XPS06	PHLP HD SCR #10-24 X 3/8"
314	XPS06	PHLP HD SCR #10-24 X 3/8"
315	X1678315	CONTROL BOX
316	XPS01	PHLP HD SCR #10-24 X 1/2"
317	XPLW03	LOCK WASHER 3/16"

REF	PART #	DESCRIPTION
318	XPN07	HEX NUT #10-24
319	XPB23	HEX BOLT 3/8"-16 X 2-1/2"
320	XPW07	FLAT WASHER 3/8"
321	XPSW10	STRAIN RELIEF 3/4"
322	X1678322	WIRING PANEL
323	XPS17M	PHLP HD SCR M4-0.7 X 6MM
324	X1678324	CONTROL PANEL
325	XPS06	PHLP HD SCR #10-24 X 3/8"
328	X1678328	EMERGENCY STOP SWITCH
332	X1678332	WIRING BLOCK
334	XPS22	PHLP HD SCR #10-24 X 5/8"
335	XPN07	HEX NUT #10-24
336	X1678336	CABLE MARKER
337	X1678337	MAIN PWR CBL 14' 12-GA
340	X1678348	LABEL (ELECTRICITY)
342	X1678350	3/4" FUSE 10A, 250V
343	X1678351	DUST PLUG
344	X1678352	STRAIN RELIEF 5/8"
346	X1678346	RHEOSTAT
347	X1678347	LABEL (READ MANUAL)
348	X1678348	FEED MOTOR SWITCH
349	X1678349	NYLON CABLE TIES

NOTES

NOTES

NOTES

FOLD ALONG DOTTED LINE

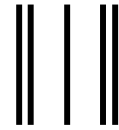
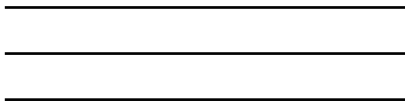

Place
Stamp
Here



WOODSTOCK INTERNATIONAL, INC.
P.O. BOX 2309
BELLINGHAM, WA 98227-2309



FOLD ALONG DOTTED LINE

TAPE ALONG EDGES--PLEASE DO NOT STAPLE

WARRANTY CARD

Name _____
 Street _____
 City _____ State _____ Zip _____
 Phone Number _____ E-Mail _____ FAX _____
MODEL # _____ Serial # _____ Date of Purchase: _____ Time in Use: _____

The following information is given on a voluntary basis and is strictly confidential.

CUT ALONG DOTTED LINE

1. Where did you purchase your **SHOP FOX®** machine?

2. How did you first learn about us?
 ___ Advertisement ___ Friend
 ___ Mail order Catalog ___ Local Store
 ___ World Wide Web Site
 ___ Other _____
3. Which of the following magazines do you subscribe to.
 ___ American Woodworker ___ Today's Homeowner
 ___ Cabinetmaker ___ Wood
 ___ Family Handyman ___ Wooden Boat
 ___ Fine Homebuilding ___ Wood shop News
 ___ Fine Woodworking ___ Woodsmith
 ___ Home Handyman ___ Woodwork
 ___ Journal of Light Construction ___ Woodworker
 ___ Old House Journal ___ Woodworker's Journal
 ___ Popular Mechanics ___ Workbench
 ___ Popular Science ___ American How-To
 ___ Popular Woodworking
 ___ Other _____
4. Which of the following woodworking/remodeling shows do you watch?
 ___ Backyard America ___ The New Yankee Workshop
 ___ Home Time ___ This Old House
 ___ The American Woodworker ___ Woodwright's Shop
 ___ Other _____
5. What is your annual household income?
 ___ \$20,000-\$29,999 ___ \$60,000-\$69,999
 ___ \$30,000-\$39,999 ___ \$70,000-\$79,999
 ___ \$40,000-\$49,999 ___ \$80,000-\$89,999
 ___ \$50,000-\$59,999 ___ \$90,000 +
6. What is your age group?
 ___ 20-29 ___ 50-59
 ___ 30-39 ___ 60-69
 ___ 40-49 ___ 70 +
7. How long have you been a woodworker?
 ___ 0 - 2 Years ___ 8 - 20 Years
 ___ 2 - 8 Years ___ 20+ Years
8. How would you rank your woodworking skills?
 ___ Simple ___ Advanced
 ___ Intermediate ___ Master Craftsman
9. How many **SHOP FOX®** machines do you own? _____
10. What stationary woodworking tools do you own? Check all that apply.
 ___ Air Compressor ___ Panel Saw
 ___ Band Saw ___ Planer
 ___ Drill Press ___ Power Feeder
 ___ Drum Sander ___ Radial Arm Saw
 ___ Dust Collector ___ Shaper
 ___ Horizontal Boring Machine ___ Spindle Sander
 ___ Jointer ___ Table Saw
 ___ Lathe ___ Vacuum Veneer Press
 ___ Mortiser ___ Wide Belt Sander
 ___ Other _____
11. Which benchtop tools do you own? Check all that apply.
 ___ 1" x 42" Belt Sander ___ 6" - 8" Grinder
 ___ 5" - 8" Drill Press ___ Mini Lathe
 ___ 8" Table Saw ___ 10" - 12" Thickness Planer
 ___ 8" - 10" Bandsaw ___ Scroll Saw
 ___ Disc/Belt Sander ___ Spindle/Belt Sander
 ___ Mini Jointer
 ___ Other _____
12. Which portable/hand held power tools do you own? Check all that apply.
 ___ Belt Sander ___ Orbital Sander
 ___ Biscuit Joiner ___ Palm Sander
 ___ Circular Saw ___ Portable Planer
 ___ Detail Sander ___ Saber Saw
 ___ Drill/Driver ___ Reciprocating Saw
 ___ Miter Saw ___ Router
 ___ Other _____
13. What machines/supplies would you like to see?

14. What new accessories would you like Woodstock International to carry?

15. Do you think your purchase represents good value?
 ___ Yes ___ No
16. Would you recommend **SHOP FOX®** products to a friend?
 ___ Yes ___ No
17. Comments: _____

Free Manuals Download Website

<http://myh66.com>

<http://usermanuals.us>

<http://www.somanuals.com>

<http://www.4manuals.cc>

<http://www.manual-lib.com>

<http://www.404manual.com>

<http://www.luxmanual.com>

<http://aubethermostatmanual.com>

Golf course search by state

<http://golfingnear.com>

Email search by domain

<http://emailbydomain.com>

Auto manuals search

<http://auto.somanuals.com>

TV manuals search

<http://tv.somanuals.com>