



MODEL W1708 Disc Sander



INSTRUCTION MANUAL

Phone: 1-360-734-3482 • On-Line Technical Support: tech-support@woodstockint.com

COPYRIGHT © September, 2003 BY WOODSTOCK INTERNATIONAL, INC.
**WARNING: NO PORTION OF THIS MANUAL MAY BE REPRODUCED IN ANY SHAPE OR FORM WITHOUT
THE WRITTEN APPROVAL OF WOODSTOCK INTERNATIONAL, INC.**

Printed in China

WARNING

Some dust created by power sanding, sawing, grinding, drilling, and other construction activities contains chemicals known to the State of California to cause cancer, birth defects or other reproductive harm. Some examples of these chemicals are:

- Lead from lead-based paints.
- Crystalline silica from bricks, cement, and other masonry products.
- Arsenic and chromium from chemically treated lumber.

Your risk from these exposures varies, depending on how often you do this type of work. To reduce your exposure to these chemicals: work in a well ventilated area, and work with approved safety equipment, such as those dust masks that are specially designed to filter out microscopic particles.

CONTENTS

INTRODUCTION	2
About Your New Disc Sander	2
Woodstock Service and Support	2
Warranty and Returns	3
Specifications	3
SAFETY FIRST!	4
Standard Safety Instructions	4
Disc Sander Components	6
Additional Safety Instructions for Disc Sanders	7
110V Operation	8
Extension Cords	8
Grounding	8
ASSEMBLY	9
Overview	9
Box Contents.....	9
Shop Preparation	9
Cleaning Machine	10
ADJUSTMENTS	11
General Information	11
Adjusting Table	11
Table Tilt	12
Replacing the Sandpaper	12
Disc Sanding	13
OPERATIONS	13
Test Run.....	13
Miter Sanding	14
Angle Sanding	14
Table.....	15
General	15
Lubrication	15
MAINTENANCE	15
PARTS	16
Closure	16
W1708 Disc Sander	17
Parts List	18

USE THE QUICK GUIDE PAGE LABELS TO SEARCH OUT INFORMATION FAST!





INTRODUCTION

About Your New Disc Sander

Your new **SHOP FOX®** Disc Sander has been specially designed to provide many years of trouble-free service. Close attention to detail, ruggedly built parts and a rigid quality control program assure safe and reliable operation.

The Model W1708 is a very versatile and easy to use disc sander. This machine can perform a wide variety of sanding operations. This disc sander features a 1 HP motor, a tilting cast iron table, a miter gauge, a built in 2" dust port, and a 12" sanding disc.

Woodstock International, Inc. is committed to customer satisfaction in providing this manual. It is our intent to make sure all the information necessary for safety, ease of assembly, practical use and durability of this product be included.

If you need the latest edition of this manual, you can download it from <http://www.shopfox.biz>. If you still have questions after reading the latest manual, or if you have comments please contact us at:

Woodstock International, Inc.
Attn: Technical Support Department
P.O. Box 2309
Bellingham, WA 98227

Woodstock Service and Support

We stand behind our machines! In the event that a defect is found, parts are missing or questions arise about your machine, please contact Woodstock International Service and Support at 1-360-734-3482 or send e-mail to: tech-support@shopfox.biz Our knowledgeable staff will help you troubleshoot problems, send out parts or arrange warranty returns.

Warranty and Returns

Woodstock International, Inc. warrants all **SHOP FOX**® machinery to be free of defects from workmanship and materials for a period of 2 years from the date of original purchase by the original owner. This warranty does not apply to defects due directly or indirectly to misuse, abuse, negligence or accidents, lack of maintenance, or to repairs or alterations made or specifically authorized by anyone other than Woodstock International, Inc.

Woodstock International, Inc. will repair or replace, at its expense and at its option, the **SHOP FOX**® machine or machine part which in normal use has proven to be defective, provided that the original owner returns the product prepaid to the **SHOP FOX**® factory service center or authorized repair facility designated by our Bellingham, WA office, with proof of their purchase of the product within 2 years, and provides Woodstock International, Inc. reasonable opportunity to verify the alleged defect through inspection. If it is determined there is no defect, or that the defect resulted from causes not within the scope of Woodstock International Inc.'s warranty, then the original owner must bear the cost of storing and returning the product.

This is Woodstock International, Inc.'s sole written warranty and any and all warranties that may be implied by law, including any merchantability or fitness, for any particular purpose, are hereby limited to the duration of this written warranty. We do not warrant that **SHOP FOX**® machinery complies with the provisions of any law or acts. In no event shall Woodstock International, Inc.'s liability under this warranty exceed the purchase price paid for the product, and any legal actions brought against Woodstock International, Inc. shall be tried in the State of Washington, County of Whatcom. We shall in no event be liable for death, injuries to persons or property or for incidental, contingent, special or consequential damages arising from the use of our products.

Every effort has been made to ensure that all **SHOP FOX**® machinery meets high quality and durability standards. We reserve the right to change specifications at any time because of our commitment to continuously improve the quality of our products.

Specifications

Motor Size	1 HP, 110V, 60 Hz
Motor Speed	1725 RPM
Amps	10 A
Sanding Disc	12"
Disc Speed	1725 RPM
Table	17 ¹ / ₄ " x 8 ¹ / ₄ "
Power Transfer	Direct Drive
Bearings	Sealed, Permanantly Lubricated
Switch	Paddle ON/OFF Switch, w/Safety Lock Key
Machine Weight	68 lbs

SAFETY FIRST!

**READ MANUAL BEFORE OPERATING MACHINE.
FAILURE TO FOLLOW INSTRUCTIONS BELOW WILL
RESULT IN PERSONAL INJURY.**



Indicates an imminently hazardous situation which, if not avoided, WILL result in death or serious injury.



Indicates a potentially hazardous situation which, if not avoided, COULD result in death or serious injury.



Indicates a potentially hazardous situation which, if not avoided, MAY result in minor or moderate injury, MAY result in property damage.

NOTICE

This symbol is used to alert the user to useful information about proper operation of the equipment.

Standard Safety Instructions

1. **Thoroughly read the instruction manual before operating your machine.** Learn the applications, limitations and potential hazards of this machine. Keep manual in a safe, convenient place for future reference. Make sure any other operators have read and understand the manual as well.
2. **Keep work area clean and well lighted.** Clutter and inadequate lighting invite potential hazards.
3. **Ground all tools.** If a machine is equipped with a three-prong plug, it must be plugged into a three-hole grounded electrical outlet or grounded extension cord. If using an adapter to aid in accommodating a two-hole receptacle, ground using a screw to a known ground.
4. **Wear eye protection at all times.** Use safety glasses with side shields or safety goggles that meet the national safety standards, while operating this machine.
5. **Avoid dangerous environments.** Do not operate this machine in wet or open flame environments. Airborne dust particles could cause an explosion and severe fire hazard.
6. **Ensure all guards are securely in place and in working condition.**
7. **Make sure switch is in the "OFF" position** before connecting power to machine.
8. **Keep work area clean, free of clutter, grease, etc.**
9. **Keep children and visitors away.** Visitors should be kept at a safe distance away while operating.
10. **Childproof workshop** with padlocks, master switches or by removing starter keys.
11. **Disconnect machine when cleaning, adjusting or servicing.**
12. **Do not force the machine.** The machine will do a safer and better job if it does the work.

13. **Use the correct tool.** Do not force the tool or attachment to do a job for which it was not designed.
14. **Wear proper apparel.** Do not wear loose clothing, gloves, jewelry, keep long hair tied up, etc.
15. **Remove adjusting keys and wrenches.** Before turning the machine on, make a habit of checking that all adjusting keys and wrenches have been removed before turning the machine *ON*.
16. **Use proper extension cord.** Examine the extension cord to ensure it is in good condition. Use **Table 1** below to determine the correct length and gauge of extension cord needed for your particular needs. The amp rating of the motor can be found on its nameplate. If the motor is dual voltage, be sure to use the amp rating for the voltage you will be using. If you use an extension cord with an undersized gauge or one that is too long, excessive heat will be generated within the circuit increasing the chance of a fire or damage to the circuit. Never use an extension cord that does not have a ground pin and connected ground wire. Immediately replace an extension cord if it shows any signs of damage.
17. **Keep stable footing and balance** at all times.
18. **Do not leave machine unattended.** Wait until it comes to a complete stop before leaving the area.
19. **Perform machine maintenance and care.** Follow lubrication and accessory attachment instructions in the manual.
20. **Keep machine away from open flame.** Operating machines near pilot lights and/or open flames creates a high risk if dust is dispersed in the area. Dust particles and an ignition source may cause an explosion. Do not operate the machine in high-risk areas, including but not limited to, those mentioned above.
21. **If at any time you are experiencing** difficulties performing the intended operation, stop using the machine! Then contact our Service Department or ask a qualified expert how the operation should be performed.
22. **Habits—good and bad—are hard to break.** Develop good habits in your shop and safety will become second-nature to you.

Table 1
Extension Cord Requirements

Amp Rating	Length And Gauge		
	25ft	50ft	100ft
0-6	#16	#16	#16
7-10	#16	#16	#14
11-12	#16	#16	#14
13-16	#14	#12	#12
17-20	#12	#12	#10
21-30	#10	#10	No

⚠ WARNING

Operating this equipment creates the potential for flying debris to cause eye injury. Always wear safety glasses or goggles when operating equipment. Everyday glasses or reading glasses only have impact resistant lenses, they are not safety glasses. Be certain the safety glasses you wear meet the appropriate standards of the American National Standards Institute (ANSI).





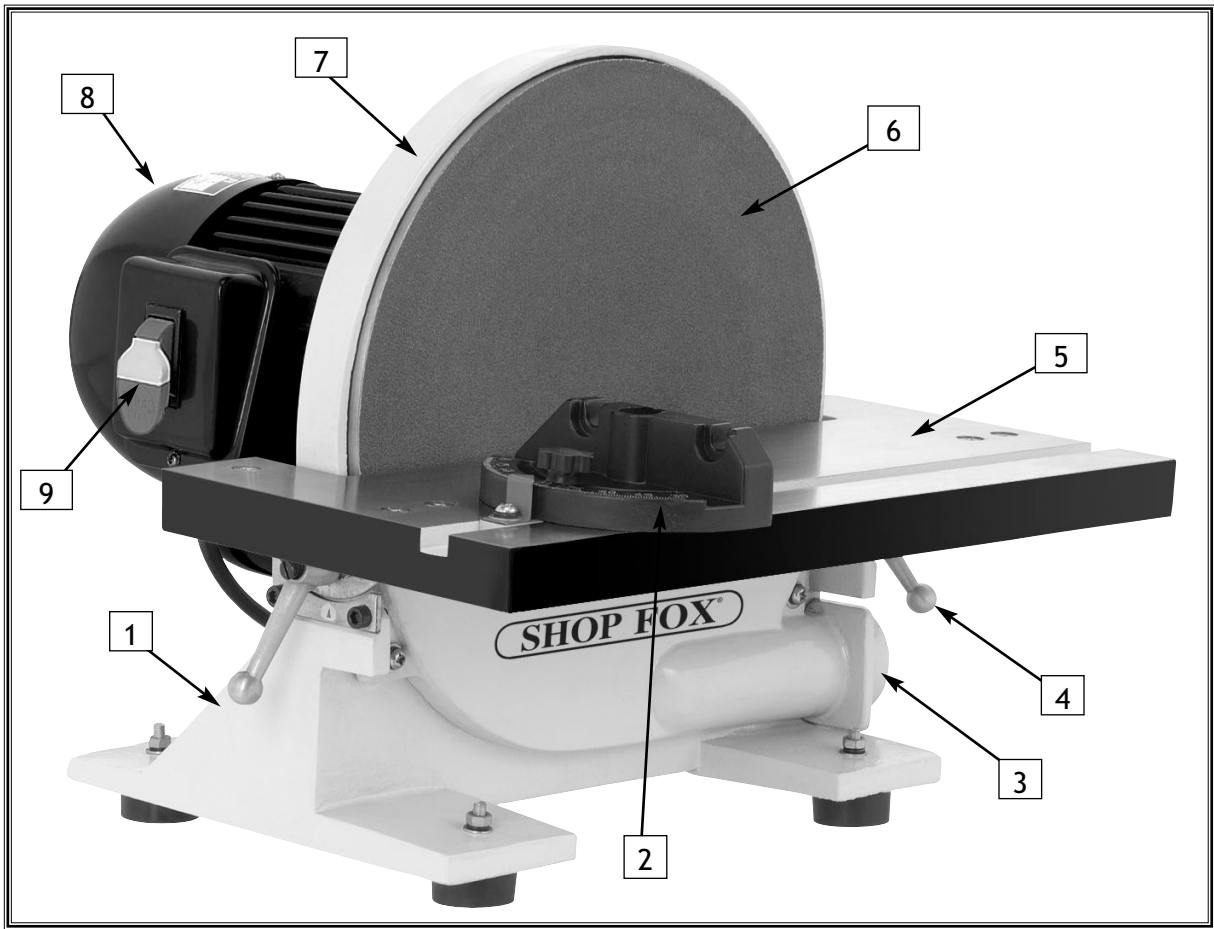



Figure 1. Machine Identification.

Disc Sander Components

1. Base
2. Miter Gauge
3. Dust Port
4. Table Lock Handle
5. Work Table
6. Precision Ground Disc (Sanding Disc Attached)
7. Disc Guard
8. Motor
9. ON/OFF Switch

Additional Safety Instructions for Disc Sanders

1. Always disconnect the machine from the power source when moving or servicing the disc sander!
2. All inspections, adjustments, and maintenance **MUST** be done with the power off and the power cord unplugged. Wait for disc to come to a complete stop.
3. Always keep your fingers away from the moving disc. Serious personal injury could occur.
4. Never operate this disc sander if the disc is worn or damaged. Inspect disc before each use. Worn discs stress the motor and can burn the workpiece.
5. Never use excessive force when sanding. This causes motor overload and increases the chance of fingers slipping into the disc.
6. Always feed the material into the portion of the disc that is spinning down toward the table.
7. Always place material flat on the surface of the table before sanding.
8. If there is any doubt as to the stability of the material to be sanded, do not sand it.
9. If you ever experience difficulties performing the intended sanding operation, stop using the disc sander! Then contact our service department or ask a qualified expert how the operation should be performed.
10. Always wear a dust mask or respirator when sanding even if you have a reliable method of dust collection.
11. Sanding dust from some woods may be toxic or cause an allergic reaction. Be sure to wear an appropriate respirator when working around wood dust. Make sure there is adequate ventilation or a constant source of fresh air. The dust from some species of wood can be toxic to some people. Be sure to research the dangers of the specific species of wood you are working with.

 <p>SHOP FOX MODEL W1708 Disc Sander INSTRUCTION MANUAL</p>	<p>! WARNING</p> <p>READ and understand this entire instruction manual before performing any operations with your machine. Serious personal injury may occur if safety and operational information is not understood and followed.</p>
--	---

<p>! CAUTION</p>	<p>USE this and other machinery with caution and respect. No list of safety guidelines can be complete. Every shop environment is different. Always consider safety first, as it applies to your individual working conditions. Failure to follow guidelines could result in serious personal injury, damage to equipment or poor work results.</p>
-------------------------	---

Electrical Requirements

SAFETY

110V Operation

The SHOP FOX® W1708 has a 1 HP, 110V, 60 Hz motor that draws approximately 10 amps under load.

Use a 15 amp circuit breaker in a circuit that has wiring rated to handle this amperage draw. Keep in mind that a circuit being used by other machines or tools at the same time will add to the total load being applied. Add up the load ratings of all the machines on the circuit. If this number exceeds the rating of the circuit breaker or wiring, use a different circuit.

Extension Cords

When it is necessary to use an extension cord, follow the guidelines below:

- Use cords rated for Standard Service
- Never use cords longer than 100 feet
- Use cords with 16 gauge wire
- Always use cords with a grounding pin
- Never use damaged cords

Grounding

This machine must be grounded! If your outlet does not accommodate a ground pin (Figure 2), have the outlet replaced by a qualified electrician or have an appropriate adapter installed and grounded properly. An adapter with a grounding wire does not guarantee that the machine will be grounded. A ground source must be verified!

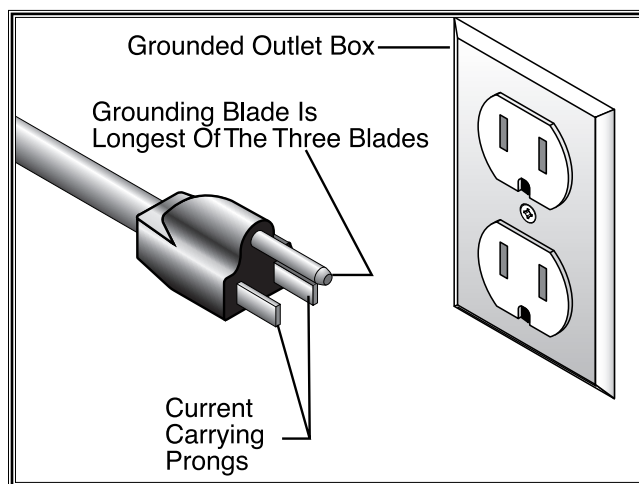
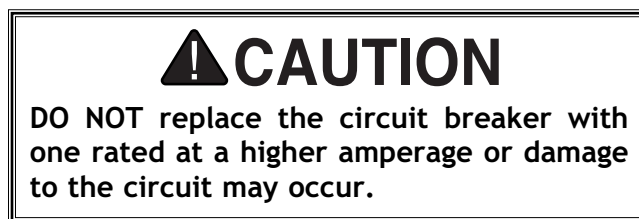
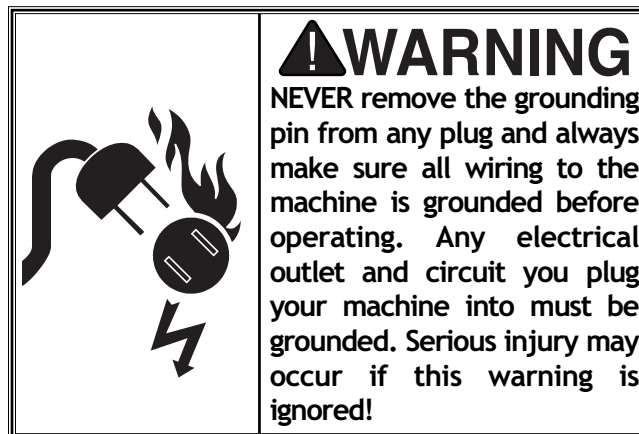

Figure 2. 110V plug and outlet.

ASSEMBLY

Overview

The following is a description of the components shipped with the SHOP FOX® W1708 12" Disc Sander.

Should any parts be missing, examine the packaging carefully to be sure parts are not among the packing materials. If any parts are missing, contact Woodstock International, Inc. at 360-734-3482 or by e-mail at: tech-support@shopfox.biz.

Box Contents

1. Disc Sander
2. Miter Gauge
3. Sanding Disc

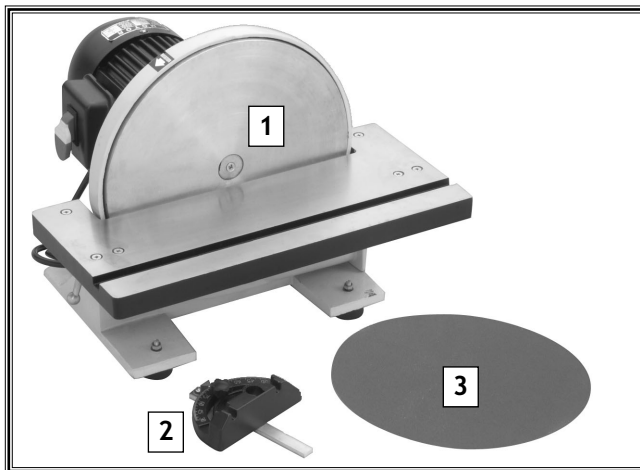

Figure 3. Disc sander components.

Shop Preparation

- **Workbench Load:** Your disc sander has a small weight load in a small footprint. Most workbenches are suitable for the disc sander. Reinforce the workbench if you question its ability to support the disc sander.
- **Working Clearances:** Consider existing and anticipated needs, size of material to be processed through each machine, and space for auxiliary stands, work tables or other machinery when establishing a location for your disc sander.
- **Lighting and Outlets:** Lighting should be bright enough to eliminate shadows and prevent eye strain. Electrical circuits should be dedicated or large enough to handle amperage requirements. Outlets should be located near each machine so power or extension cords are clear of high-traffic areas. Observe local electrical codes for proper installation of new lighting, outlets, or circuits.

	<h3>⚠ CAUTION</h3>
	<p>ALWAYS make sure that all entrances to your shop are locked or that machines are equipped with safety lock-out devices to protect curious children or visitors from serious injury. Never allow unsupervised people in your shop who have not been fully trained!</p>

	<h3>⚠ WARNING</h3>
	<p>DO NOT connect the machine to power at this time. The machine must remain unplugged throughout the entire assembly process. Failure to do this may result in serious personal injury.</p>



Cleaning Machine

The unpainted parts of the Model W1708 are coated with a waxy grease that protects them from corrosion during shipment. For optimum performance from your machine, make sure you clean all moving parts or sliding contact surfaces that are coated. Clean this grease off with a solvent cleaner or citrus-based degreaser. Do not use chlorine-based solvents—if you happen to splash some onto a painted surface, you will ruin the finish.

ASSEMBLY

	<p>! WARNING NEVER use flammables such as gas or other petroleum-based solvents to clean your machine. These products have low flash points and present the risk of explosion and severe personal injury!</p>
---	--

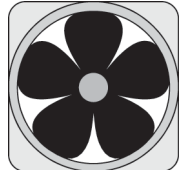
	<p>! WARNING NEVER smoke while using any cleaning solvents. Smoking may cause explosion or risk of fire when exposed to these products!</p>
--	--

 	<p>! CAUTION ALWAYS when using solvents with fumes, work in a well ventilated area and keep away from any potential ignition sources (pilot lights). Most solvents used to clean machinery are toxic when inhaled or ingested. Always dispose of any waste rags in a sealed container to make sure they do not cause fire or environmental hazards.</p>
	

ADJUSTMENTS

General Information

The adjustments in this section have been preset and generally do not need to be performed when you first receive your disc sander; however, we suggest that you become familiar with these adjustments before operating your disc sander. This will help you understand the machine and will prepare you for the types of adjustments that can be made in troubleshooting and everyday use.

Adjusting Table

The table must be parallel to the surface of the disc plate for accuracy and to prevent the sanding disc from rubbing on the table.

To align the table with the disc plate, do these steps:

1. Square the miter gauge by placing a try square or a machinist's square against the miter gauge slide as shown in **Figure 4**. Loosen the adjustment knob, push the blade of the square up to the miter gauge body, and tighten the adjustment knob.
2. Set the miter gauge in the table slot. Place the square against the miter gauge and the disc plate as shown in **Figure 5**.
3. If there is a gap between the blade of the square and the disc plate, loosen the table screws shown in **Figure 6**, and adjust the table until there is no gap between the square and the disc plate.
4. Install the sanding disc. See **Page 12**.
5. Check the gap between the table and the sanding disc. It should be $\frac{1}{16}$ ". Adjust the table until the gap is even all the way across the face of the sanding disc.
6. Tighten the table screws, recheck the gap and the table alignment, and re-adjust the table if tightening the screws has caused the table to shift.

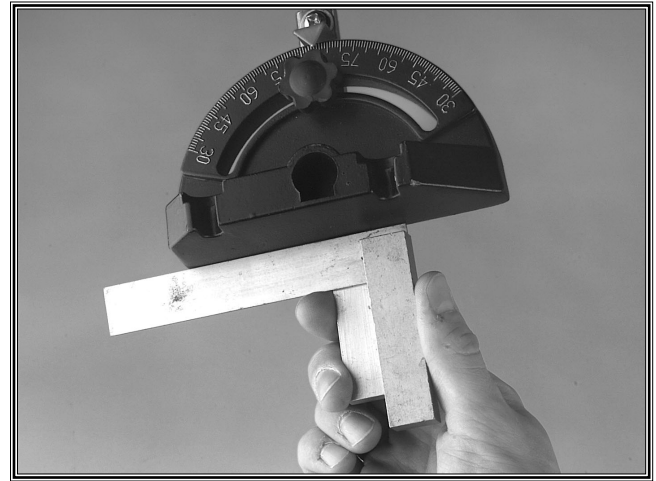

Figure 4. Squaring the miter gauge.



Figure 5. Checking table square.

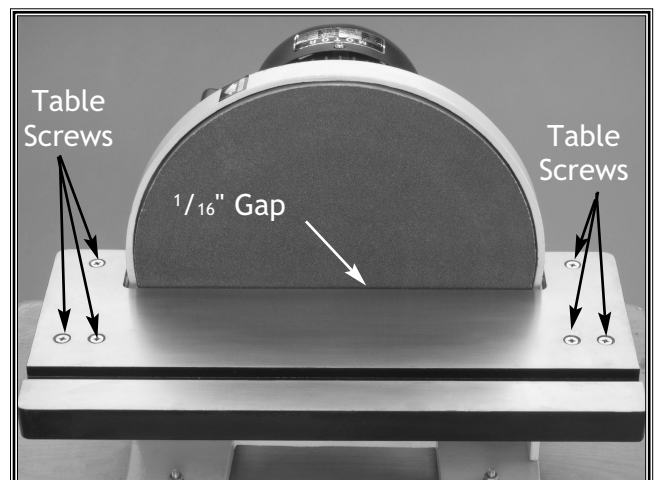

Figure 6. Aligning table with disc.

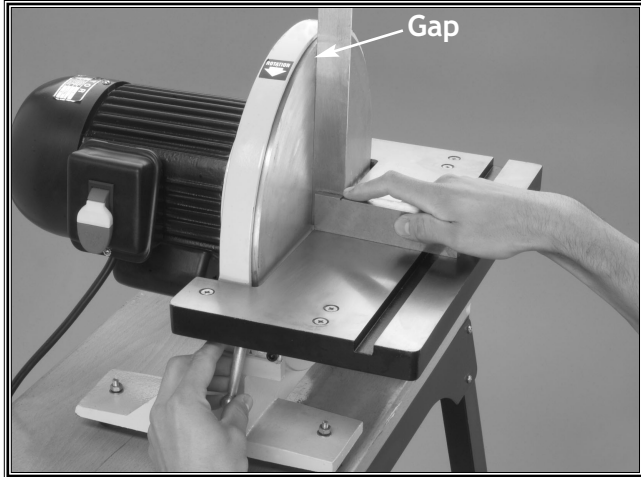

Figure 7. Checking table tilt.



Figure 8. Slide covered sandpaper between disc and table.



Figure 9. Remove paper backing

Table Tilt

To ensure accuracy, adjust the table 90° to the sanding disc.

To check table tilt, do these steps:

1. Place a try square or a machinist's square with the base flat against the table and the blade vertical against the disc plate.
2. If there is a gap between the square and the disc plate, loosen the table lock handles as shown in **Figure 7**.
3. Tilt the table until there is no gap between the square and the disc plate, tighten the table lock handles and recheck with the square to verify that the table remained aligned.
4. Remove the angle pointer and place it so that it points to 90° on the trunnion gauge.

Replacing the Sandpaper

The sandpaper can be replaced without removing the table or the dust port.

To replace the sanding disc, do these steps:

1. **UNPLUG THE DISC SANDER!**
2. Make sure that the disc plate is free of dirt, dust, and adhesive.
3. Peel back half of the sanding disc backing.
4. Slide the covered portion of the sanding disc between the disc plate and the table as shown in **Figure 8**.
5. Firmly press the exposed portion of the sanding disc to the top of the disc plate.
6. Rotate the disc plate 180°, peel back the remaining half of the sanding disc backing and press it into place (**Figure 9**).
7. Make sure the sanding disc is firmly attached before plugging in the disc sander.

OPERATIONS



Test Run

Once the adjustments are complete, the **SHOP FOX® W1708** is ready for a test run. The purpose of a test run is to identify any unusual noises and vibrations, as well as to confirm that the machine is performing as intended.

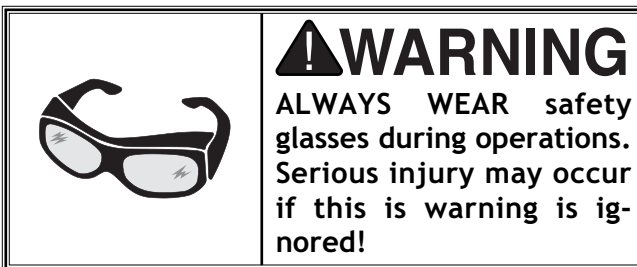

To test run the machine, do these steps:

1. Plug the machine into the power source.
2. Turn the disc sander *ON*.
3. Keep your hand over the power switch in case there is a situation that requires you to quickly turn the power *OFF*.

Your disc sander should run smoothly with no strange noises or excessive vibration. **UNPLUG** the machine before investigating any unusual noises.

Disc Sanding

To perform sanding operations, do these steps:

1. To sand a 90° angle, place the surface of the workpiece that you wish to sand against the face of the miter gauge (set at 90°).
2. Slide the workpiece into the left half of the sanding disc that is spinning downward as shown in **Figure 10**.
3. Move the workpiece across the downward spinning surface of the disc to prevent build-up on the sanding disc and burning of the workpiece.
4. Remove the miter gauge to sand curves and irregular shapes.



Figure 10. Disc sanding.

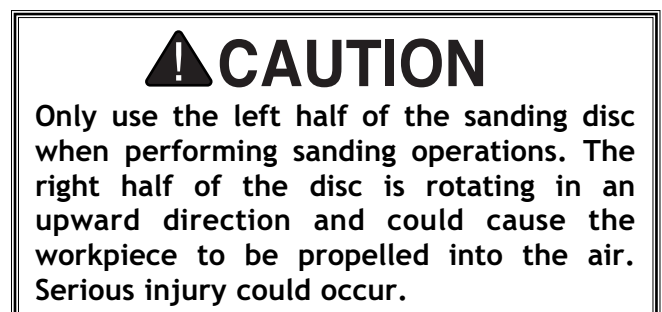

Miter Sanding

An effective way of making a perfect miter is to cut the workpiece slightly long and sand it to the desired angle.

To perform miter sanding operations, do these steps:

1. Loosen the knob on the miter gauge, adjust the miter gauge body to the desired angle and tighten the knob.
2. Hold the workpiece firmly against the miter gauge.
3. Slide the workpiece along the face of the miter gauge into the left side of the sanding disc as shown in **Figure 11**.

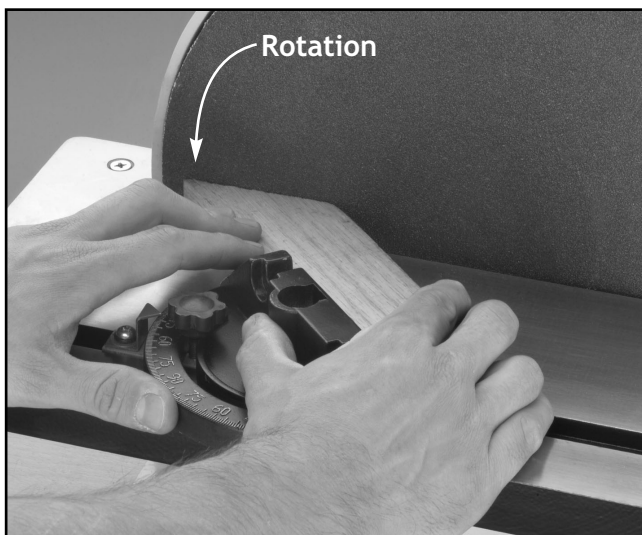

Figure 11. Mitering with gauge angled.

Angle Sanding

To perform angle sanding operations, do these steps:

1. Loosen the handles securing the table, use the angle gauge to set the angle, and tighten the table lock handles.
2. Slide the miter gauge into its slot and use it to hold your workpiece in position.
3. With light, but firm pressure, push the workpiece slowly into the downspin side of the sanding disc (**Figure 12**).

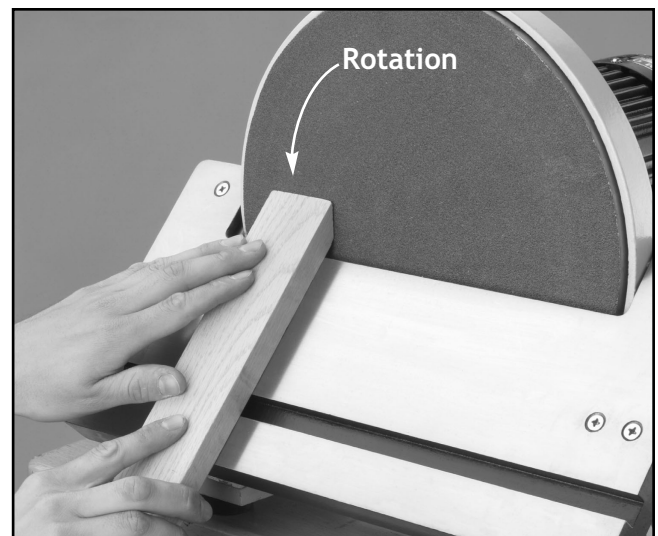

Figure 12. Mitering with table angled.

MAINTENANCE

General

Regular periodic maintenance on your Model W1708 will ensure its optimum performance. Make a habit of inspecting your sander each time you use it. Check for the following conditions and repair or replace when necessary.

1. Loose mounting bolts.
2. Worn switch.
3. Worn or damaged cords and plugs.
4. Damaged sanding disc.
5. Any other condition that could hamper the safe operation of this machine.

Table

Tables can be kept rust-free with regular applications of products like Boeshield® T-9. For long term storage you may want to consider products like Kleen Bore's Rust Guardit™.

Lubrication

Since all bearings are sealed and permanently lubricated, simply leave them alone until they need to be replaced. Do not lubricate them.

For other items on this machine, an occasional application of light machine oil is all that is necessary. Before applying lubricant, wipe the machine clean.

Your goal is to achieve adequate lubrication. Too much lubrication will attract dirt and sawdust. Various parts of your machine could lose their freedom of movement as a result.

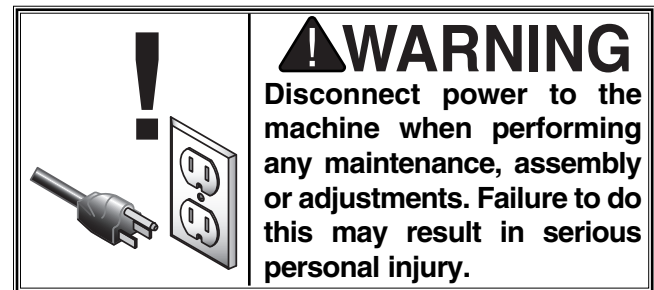

Closure

The following pages contain parts diagrams/lists and a warranty card for your **SHOP FOX®** Model W1708.

If you need parts or help in assembling your machine, or if you need operational information, we encourage you to call our Service Department. Our trained service technicians will be glad to help you.

If you have comments dealing specifically with this manual, please write to us using the address in the General Information. The specifications, drawings, and photographs illustrated in this manual represent the Model W1708 as supplied when the manual was prepared. However, due to Woodstock International, Inc.'s policy of continuous improvement, changes may be made at any time with no obligation on the part of Woodstock International, Inc. Whenever possible, though, we send manual updates to all owners of a particular tool or machine that have registered their purchase with our warranty card. Should you receive one, add the new information to this manual and keep it for reference.

We have included some important safety measures that are essential to this machine's operation. While most safety measures are generally universal, we remind you that each workshop is different and safety rules should be considered as they apply to your specific situation.

We recommend you keep this manual for complete information regarding Woodstock International, Inc.'s warranty and return policy. Should a problem arise, we recommend that you keep your proof of purchase with your manual. If you need additional technical information relating to this machine, or if you need general assistance or replacement parts, please contact the Service Department at 1-360-734-3482 or e-mail: tech-support@shopfox.biz

Additional information sources are necessary to realize the full potential of this machine. Trade journals, woodworking magazines, and your local library are good places to start.

The Model W1708 is specifically designed for sanding operations. **DO NOT MODIFY AND/OR USE THIS MACHINE FOR ANY OTHER PURPOSE. MODIFICATIONS OR IMPROPER USE OF THIS TOOL WILL VOID THE WARRANTY.** If you are confused about any aspect of this machine, **DO NOT** use it until all your questions have been answered.

WARNING

As with all power tools, there is danger associated with the Model W1708. Use the tool with respect and caution to lessen the possibility of mechanical damage or operator injury. If normal safety precautions are overlooked or ignored, injury to the operator or others is likely.

W1708 Disc Sander

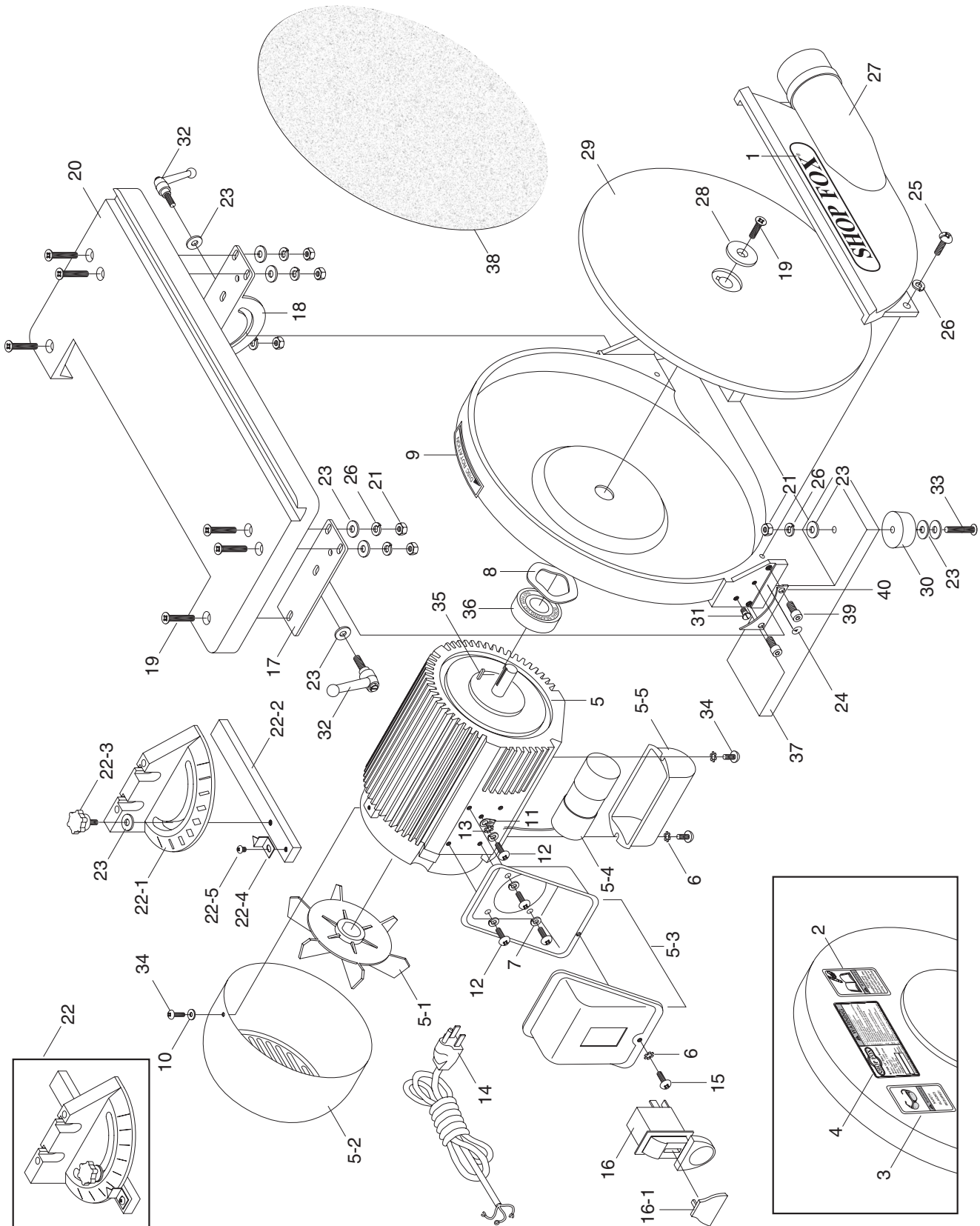

Parts List

REF	PART #	DESCRIPTION
1	X1708001	SHOP FOX LOGO LABEL
2	X1708002	READ MANUAL LABEL
3	X1708003	SAFETY GLASSES LABEL
4	X1708004	MACHINE ID LABEL
5	X1708005	MOTOR 1HP
5-1	X1708005-1	MOTOR FAN
5-2	X1708005-2	FAN COVER
5-3	X1708005-3	WIRING BOX
5-4	XPC100A	CAPACITOR 100MFD/250V
5-5	X1708005-5	CAPACITOR COVER
6	XPTLW01M	EXT TOOTH WASHER 4MM
7	XPLW01M	LOCK WASHER 5MM
8	X1708008	WAVY WASHER 39MM
9	X1708009	ROTATION ARROW LABEL
10	XPW05M	FLAT WASHER 4MM
11	X1708011	GROUND INDICATOR
12	XPS09M	PHLP HD SCR M5-.8 X 10
13	XPTLW02M	EXT TOOTH WASHER 5MM
14	X1708014	CORD & PLUG
15	XPS17M	PHLP HD SCR M4-.7 X 6
16	XPSW09	PADDLE SWITCH 110/220V
16-1	XPSW09-1	SWITCH KEY
17	X1708017	RIGHT TRUNNION
18	X1708018	LEFT TRUNNION
19	XPFH06M	FLAT HD SCR M6-1 X 20
20	X1708020	WORK TABLE

REF	PART #	DESCRIPTION
21	XPNO1M	HEX NUT M6-1
22	X1708022	COMPLETE MITER GAUGE
22-1	X1708022-1	MITER GAUGE BODY
22-2	X1708022-2	GAUGE SLIDE
22-3	X1708022-3	KNOB BOLT M6-.1 X 22
22-4	X1708022-4	ANGLE POINTER
22-5	XPS19M	PHLP HD SCR M5-.8 X 6
23	XPW03M	FLAT WASHER 6MM
24	X1708024	REFERENCE LABEL
25	XPS26M	PHLP HD SCR M6-1 X 20
26	XPLW03M	LOCK WASHER 6MM
27	X1708027	DUST CHUTE COVER
28	X1708028	SPECIAL WASHER 1/4" X 1 1/4"
29	X1708029	SANDING DISC
30	X1708030	RUBBER FOOT
31	X1708031	STOP SCREW
32	X1708032	TABLE LOCK
33	XPS47M	PHLP HD SCR M6-1 X 25
34	XPS07M	PHLP HD SCR M4-.7 X 8
35	XPK23M	KEY 5 X 5 X 25
36	XP6204	BALL BEARING 6204ZZ
37	X1708037	BASE
38	X1708038	80 GRIT SANDING DISC
39	XPSB26M	CAP SCREW M6-1 X 12
40	X1708040	TRUNNION REST

FOLD ALONG DOTTED LINE

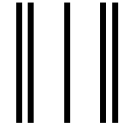
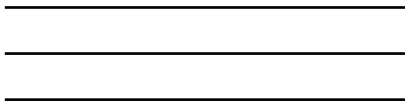

Place
Stamp
Here



WOODSTOCK INTERNATIONAL, INC.
P.O. BOX 2309
BELLINGHAM, WA 98227-2309



FOLD ALONG DOTTED LINE

TAPE ALONG EDGES--PLEASE DO NOT STAPLE

Free Manuals Download Website

<http://myh66.com>

<http://usermanuals.us>

<http://www.somanuals.com>

<http://www.4manuals.cc>

<http://www.manual-lib.com>

<http://www.404manual.com>

<http://www.luxmanual.com>

<http://aubethermostatmanual.com>

Golf course search by state

<http://golfingnear.com>

Email search by domain

<http://emailbydomain.com>

Auto manuals search

<http://auto.somanuals.com>

TV manuals search

<http://tv.somanuals.com>