

# XM Direct Home Tuner User Guide





# Table of Contents

<b>Introduction</b> .....	<b>5</b>
Features .....	6
Safety and Care Information .....	7
What's in the Box? .....	8
XM Direct Home Tuner .....	9
<b>Home Installation</b> .....	<b>11</b>
Step 1: Connect the XM Direct Home Tuner .....	12
Step 2: Install the Indoor/Outdoor Antenna .....	14
Step 3: Activate your XM Direct Home Tuner .....	19
<b>Troubleshooting</b> .....	<b>21</b>
<b>Product Specifications</b> .....	<b>25</b>
Patent Information .....	27
Environmental Information .....	27



# Introduction

# Introduction

## Features

### **Congratulations on your purchase of the XM Direct Home Tuner!**



Your new XM Direct Home Tuner lets you enjoy XM Satellite Radio on any XM-Ready home audio system. Simply connect the XM Direct Home Tuner to the XM jack on your home audio system, place and aim the antenna for optimum reception, and you're ready to start enjoying commercial-free music, plus live sports, news, talk & exclusive entertainment.

And for the latest information about this and other SIRIUSXM products and accessories, visit [xmradio.com](http://xmradio.com) or your favorite retailer.

**Please read the entire User Guide before installing your Home Kit!**

## Safety and Care Information



**IMPORTANT!** Always read and understand all the instructions to avoid injury to yourself and/or damage to your device. SIRIUS XM Radio Inc. disclaims all responsibility for damage from data loss due to breakdown, repair, or other causes.

- Do not expose to extreme temperatures (above 140°F or below -4°F, or above 60°C or below -20°C).
- Do not expose to moisture. Do not use device near or in water. Do not touch the device with wet hands.
- Do not let any foreign matter spill into device.
- Do not store in dusty areas.
- Do not expose to chemicals such as benzene and thinners. Do not use liquid or aerosol cleaners. Clean with a soft damp cloth only.
- Do not expose to direct sunlight for a prolonged period of time, and do not expose to fire, flame, or other heat sources.
- Do not try to disassemble and/or repair device yourself.
- Do not drop your device or subject it to severe impact.
- Do not place heavy objects on device.
- Do not subject device to excessive pressure.

### WARNING!

- Opening the case may result in electric shock.

# Introduction

## What's in the Box?

Home Clamshell Antenna

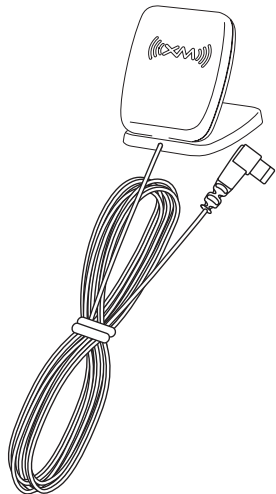

XM Direct Home Tuner

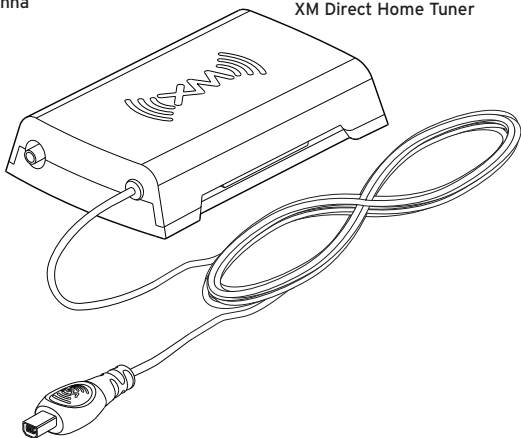

**TIP!** Use the remote control included with your home audio system to navigate through the functions of your new XM Direct Home Tuner.



## XM Direct Home Tuner

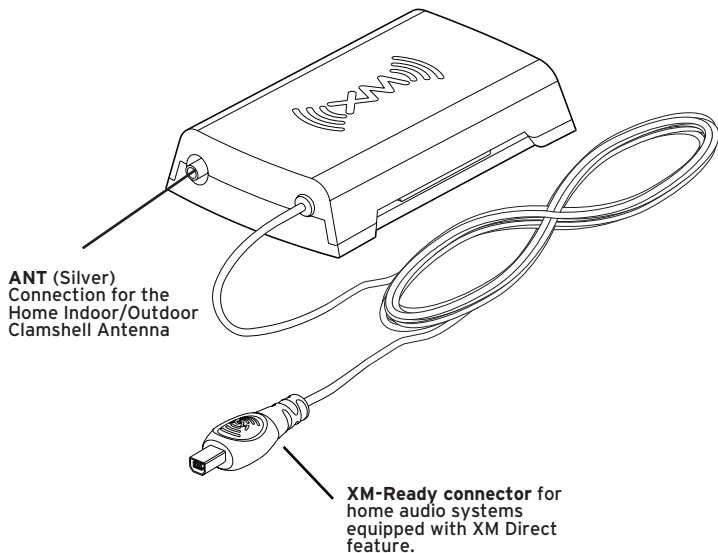



# Home Installation

# Home Installation

There are two parts to setting up your Home Kit. First, connecting the XM Direct Home Tuner to your home audio system, then placing and aiming the Home Antenna. Let's start with setting up the XM Direct Home Tuner set up.

## Step 1: Connect the XM Direct Home Tuner

When installing the XM Direct Home Tuner in your home, choose a location in close proximity to your home audio system and also where the cable from the Indoor/Outdoor Antenna can reach the XM Direct Home Tuner. Make sure the location has proper ventilation to avoid over-heating.

### Connect XM Direct Home Tuner to your stereo

Connect your XM Direct Home Tuner to your XM-Ready home audio system. With power to your XM-Ready home audio system turned off, simply connect the end of the XM Direct Home Tuner cable to the port on the back panel of your XM-Ready home audio system labeled "XM."

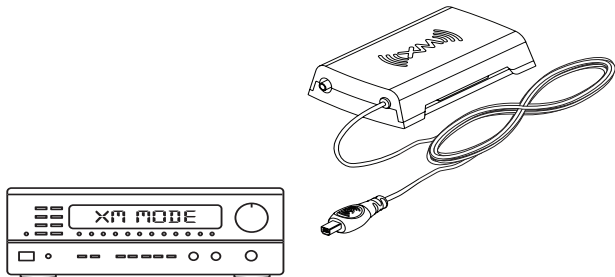

## Connect the Indoor/Outdoor Antenna

Once you have selected a location, connect the antenna to the **ANT IN** connector at the rear of the XM Direct Home Tuner. (After completing a few additional steps, we will work on the location of the antenna.)

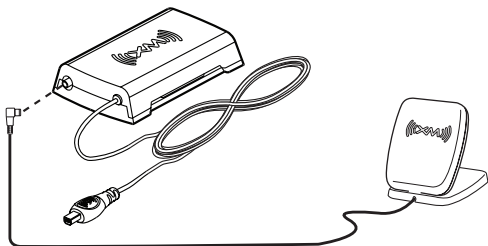

## Selecting your XM-Ready home audio system's XM input

Turn on your XM-Ready home audio system and make sure to select the correct input for your XM Direct Home Tuner. Please refer to your home audio system's manual for more information.

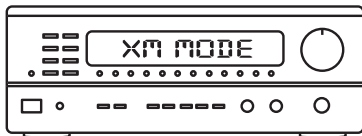

# Home Installation

## Step 2: Install the Indoor/Outdoor Antenna

To begin, try experimenting with the Home Antenna to get a feel for the reception in your location. Move the antenna around the room or from room to room. Aim it from different windows. In major metropolitan areas, you might find that you get great reception in several locations without worrying too much about aim and placement.

Refer to your XM-Ready home audio system's User Guide for instructions, and access the **Signal** or **Signal Indicator** screen to see a visual indication of signal strength. If you're receiving a good Satellite and Terrestrial signal strength, you're done. If not, try some of the suggestions which follow.

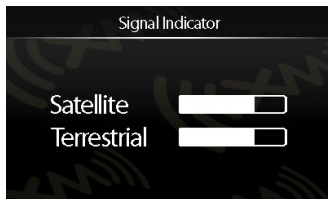

### *Other Indoor/Outdoor Antenna Installation Suggestions*

If you find you are getting a signal, but it's inconsistent, try moving the Indoor/Outdoor Antenna closer to a window, ideally one that is facing due south.

Not sure which way is south? Think about where the sun rises (in the east) and sets (in the west). Then stand so that

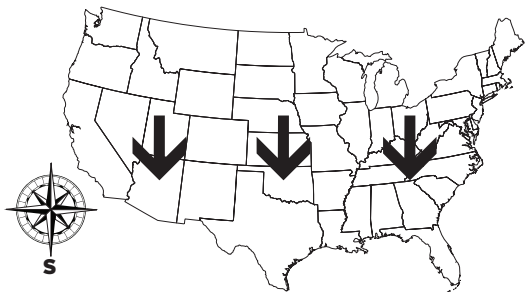

east is to your left and you'll be facing south. Is there a window in the direction you're facing? Move the antenna closer to the window.



**TIP!** Still not sure which way is south or where to place your Home Antenna? Look up your location on an online mapping Web site that offers satellite views of street addresses where you can easily see which way is south, and what window may offer an unobstructed view of the sky.

Another easy method is to start at any window, then work from window to window in a simple pattern to find the window gives the best signal strength. Note that the antenna must also have an unobstructed view. No trees or buildings blocking its aim. If the antenna is aimed through a window, be aware that blinds, screens, or any other non-glass elements such as thermal insulation can sometimes cause reception issues. If this is the case, you may want to use another window or place the antenna outside of the window.

If you find a window that gives you good signal strength, you can place the antenna on the windowsill. The antenna may need to be placed on something to raise it above the level of the window frame.

If you don't have a window where you receive a consistent signal, or placing the antenna in a window is not a practical solution for you, **BETTER** reception can be achieved by placing the antenna outside on a window ledge, porch, table, or patio. The location you choose should

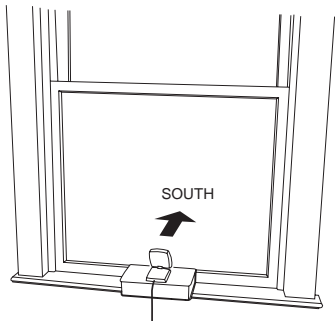

# Home Installation

provide the antenna with a clear view of the southern sky.

If none of the previous solutions work for you, then the **BEST** reception can be achieved by mounting the antenna outdoors, with a clear view of the southern sky.

Note that you will want to consider any potential hazards when you choose the mounting location, and possibly consider professional installation. SIRIUS XM Radio Inc. is not liable for any damages.

To mount the antenna, you will need four screws (not included) with a 1/4" head (e.g., an M3 screw), and that are suitable for the material onto which you are affixing the antenna, (e.g., wood, metal, etc.). The screws should be spaced 1-3/8" apart horizontally and 1-1/8" vertically. Refer to the template on "Indoor/Outdoor Antenna Template" on page 30.

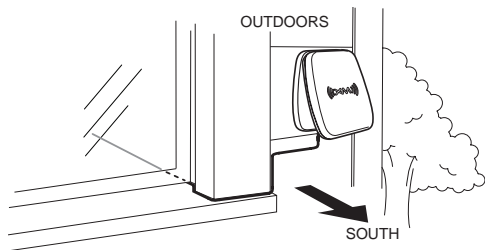
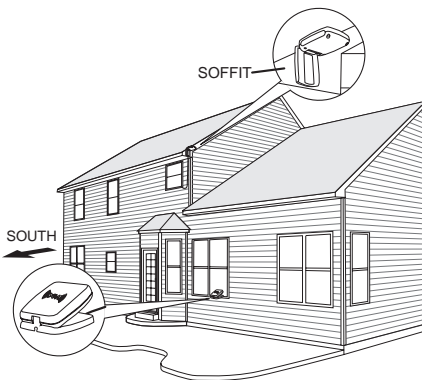



Once you have found a suitable location for the antenna, route the antenna cable to the XM Direct Home Tuner. Be sure you avoid any obstructions that could crimp, kink, or twist the cable. Use protective grommets wherever rough openings are encountered. If the antenna is installed outdoors, route the cable from the antenna location to the interior of the home, working the cable through the basement, under a window sill, etc., and make adjustments to take up cable slack as necessary.

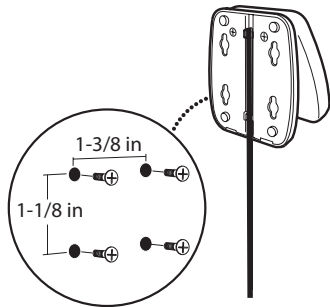

**TIP!** If your Indoor/Outdoor Antenna's cable isn't long enough, visit [xmradio.com/accessories](http://xmradio.com/accessories), or your favorite retailer, and consider a 50 ft. Indoor/Outdoor Antenna Extension Cable or a Wireless Home Signal Repeater.

If the signal is good for either Satellite or Terrestrial (or both), and you are hearing the audio from the the home audio system, the installation is complete.

If the signal reception is low, or intermittent, try another location for the antenna. Verify that the antenna is pointed south, and that the antenna's view of the sky is not blocked by a tree, a building, a bridge, or anything else. Adjust until you are receiving a good signal.

The Indoor/Outdoor Antenna's reception can also be tweaked by opening or closing the antenna clamshell, and turning the antenna. While observing the signal strength, make small adjustments to the angle of tilt of the clamshell

# Home Installation

until the highest possible signal strength is achieved. If you have not wall-mounted the antenna, turn the antenna slightly to the right or left and observe if the signal strength increases. For each tweak, allow a few seconds in each position to determine if the signal strength increases.

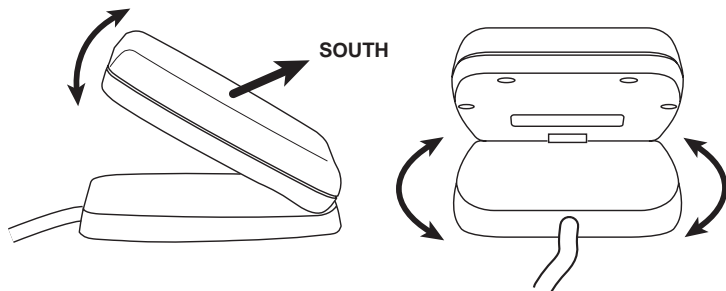

If the signal reception is good, but there is no audio, verify that the XM Direct Home Tuner has a good connection to the XM input on the back of your audio system. Also, be sure that the system is set to the XM tuner input source and the volume is raised to an audible level.

If you still have questions, for example, 'Are there any other options/things I should consider?', etc., refer to "Troubleshooting" on page 22.

## Step 3: Activate your XM Direct Home Tuner

Before you can enjoy commercial-free music, plus live sports, news, talk & exclusive entertainment, you need to activate your XM Direct Home Tuner.

- 1 Make sure your XM Direct Home Tuner is properly installed, turned on, and receiving the XM signal so that you can hear the audio on channel 1.
- 2 Make a note of your XM Radio ID. You can find it on channel 0, on a label on the bottom of the gift box, and on the label on the bottom of your XM Direct Home Tuner.

**NOTE!** The XM Radio ID does not use the letters I, O, S, or F.

- 3 Activate your service:

- Online: Go to **www.xmradio.com** and click on "ACTIVATE RADIO" in the top right corner

**OR**

- By phone: Call **1-800-XM-RADIO (1-800-967-2346)**

- 4** When your service is activated, your XM Direct Home Tuner will receive all channels to which you have subscribed. At this time, if you press the channel up or channel down buttons on your home audio system, you can scroll and tune other channels. Activation usually takes 10 to 15 minutes, but may take up to an hour. We recommend that your home audio system remain on until activated.



# Troubleshooting

Your XM Direct Home Tuner has been designed and built to be trouble-free, but if you experience a problem, try this:

- Check that all connections are firm and secure.
- Make sure you have connected the XM Direct Home Tuner as described in this User Guide.
- Check the home audio system's front panel display or connected TV screen for system messages. If you see any of these items try the solution shown.
- Note that some of these items may be abbreviated depending on the display capabilities of the connected audio device.

If you see this on the screen:	Try this:
No Signal	<ul style="list-style-type: none"><li>• Move the antenna to a south-facing window. Not sure which way is south? Think about where the sun rises (in the east) and sets (in the west). Then stand so that east is to your left and you'll be facing south. Is there a window in the direction you're facing?</li><li>• You may need to find a better location for the antenna. Refer to "Step 2: Install the Indoor/Outdoor Antenna" on page 14.</li></ul>
Check Antenna	<ul style="list-style-type: none"><li>• Make sure that the Indoor/Outdoor Antenna cable is firmly and securely plugged into the XM Direct Home Tuner. Make sure the cable is not bent or broken.</li></ul>
Channel Off Air	<ul style="list-style-type: none"><li>• The channel you've selected is not currently broadcasting. Tune to another channel.</li></ul>
Loading	<ul style="list-style-type: none"><li>• Your Tuner is acquiring audio or program information. This message usually goes away in a few seconds.</li></ul>

If you see this on the screen:	Try this:
Check XM Tuner	<ul style="list-style-type: none"> <li>• Confirm the XM Direct Home Tuner cable is fully connected to the home audio system.</li> </ul>
Channel Unauthorized	<ul style="list-style-type: none"> <li>• You selected a channel that is blocked or cannot be received with your XM subscription package.</li> <li>• Consult the latest channel guide at <a href="http://www.xmradio.com">www.xmradio.com</a> for the current list of channels.</li> </ul>
Channel Unavailable	<ul style="list-style-type: none"> <li>• The selected channel is not available. The channel may have been reassigned to a different channel number.</li> <li>• Consult the latest channel guide at <a href="http://www.xmradio.com">www.xmradio.com</a> for the current list of channels.</li> </ul>
Updating	<ul style="list-style-type: none"> <li>• Your tuner is being updated with the latest encryption code. Wait until the update is done.</li> <li>• You may be trying to tune to a channel that is blocked or unavailable. Tune to another channel.</li> </ul>
-	<ul style="list-style-type: none"> <li>• No program information, such as artist name, song title, or channel exists.</li> </ul>

**If this happens:**

You do not receive all the channels to which you subscribed	<ul style="list-style-type: none"><li>• If you have not yet activated your service, refer to the Activation section in the User Guide which accompanied your radio.</li></ul>
No audio	<ul style="list-style-type: none"><li>• Check all cables between your tuner and your home audio system for a firm and secure connection.</li><li>• Ensure you have selected the proper input source on your home audio system.</li></ul>
Audio fades or has static when listening	<ul style="list-style-type: none"><li>• Check all cables for a firm and secure connection.</li></ul>
No song title or artist name is displayed	<ul style="list-style-type: none"><li>• The information may not be available or updates may be in progress.</li></ul>
Traffic and Weather channels sound different from other channels	<ul style="list-style-type: none"><li>• These channels use a different audio technology than other channels so they often sound different from other channels.</li></ul>



# Product Specifications

# Product Specifications

## Connector

Type

Male (XM Direct)

Cable length

3.3 feet (1 meter)

## Dimensions

85 mm (W) X 52 mm (H) X 17.45 mm (D)

3.35 in (W) X 2.05 in (H) X 0.69 in (D)

## Weight

2.0 oz (56 g)

## Power requirements

5V DC, 0.3A (Max) supplied by XM-Ready home audio system

## Operating Temperature

-4° F to +140° F (-20° C to+60° C)

## Antenna

Type

Indoor/Outdoor Clamshell

Connector

SMB Male

Cable length

21 feet (6.4meters)

# Patent and Environmental Information

## Patent Information

It is prohibited to, and you agree that you will not, copy, decompile, disassemble, reverse engineer, hack, manipulate, or otherwise access and/or make available any technology incorporated in this product. The music, talk, news, entertainment, data, and other content on the Services are protected by copyright and other intellectual property laws and all ownership rights remain with the respective content and data service providers. You are prohibited from any export of the content and/or data (or derivative thereof) except in compliance with applicable export laws, rules and regulations. The user of this or any other software contained in a SIRIUS|XM radio is explicitly prohibited from attempting to copy, decompile, reverse engineer, hack, manipulate or disassemble the object code, or in any other way convert the object code into human-readable form.

## Environmental Information

Follow local guidelines for waste disposal when discarding packaging and electronic appliances.

Your Home Kit is packaged with cardboard, polyethylene, etc., and does not contain any unnecessary materials.

**WARNING:** This product contains chemicals known to the State of California to cause cancer and birth defects or other reproductive harm.

# FCC Statement

The user is cautioned that changes or modifications not expressly approved by SIRIUS XM Radio Inc. can void the user's authority to operate this device.

This device complies with Part 15 of the FCC Rules. Operation is subject to the following two conditions:

1. This device may not cause harmful interference.
2. This device must accept any interference received, including interference that may cause undesired operation.

This equipment has been tested and found to comply with the limits for a Class B digital device, pursuant to Part 15 of the FCC Rules. These limits are designed to provide reasonable protection against harmful interference in a residential installation.

This equipment generates, uses, and can radiate radio frequency energy and, if not installed and used in accordance with the installation instructions, may cause harmful interference to radio communications. However, there is no guarantee that interference will not occur in a particular installation. If this equipment does cause harmful interference to radio or television reception, which can be determined by turning the equipment off and on, the user is encouraged to try to correct the interference by one or more of the following measures:

- Reorient or relocate the receiving antenna of the affected receiver.
- Increase the separation between the SIRIUS|XM equipment and the affected receiver.
- Connect the SIRIUS|XM equipment into an outlet on a circuit different from that to which the affected receiver is connected.
- Consult the dealer or an experienced radio/TV technician for help.

**WARNING!** The FCC and FAA have not certified Satellite Radio Receiver use in any aircraft (neither portable nor permanent installation). Therefore, SIRIUS XM Radio Inc. cannot support this type of application or installation.

# Copyrights and Trademarks

Hardware and subscription sold separately. Activation fee, other fees, and taxes required. Installation required with some equipment. Except for the MiRGE radio, and as specifically provided, SIRIUS and XM Radios and accessories are compatible only with their respective subscription service. Subscriptions governed by, as applicable, the SIRIUS Terms & Conditions available at [sirius.com](http://sirius.com), or the XM Customer Agreement available at [xmradio.com](http://xmradio.com). Prices and programming are subject to change. SIRIUS XM U.S. Service only available in the 48 contiguous United States and D.C. Service available in Canada; see [www.siriuscanada.ca](http://www.siriuscanada.ca) or [www.xmradio.ca](http://www.xmradio.ca). © 2010 SIRIUS XM Radio Inc. SIRIUS, XM and all related marks and logos are trademarks of SIRIUS XM Radio Inc. and its subsidiaries. All other trademarks, service marks and logos are the property of their respective owners. All rights reserved.

# Indoor/Outdoor Antenna Template

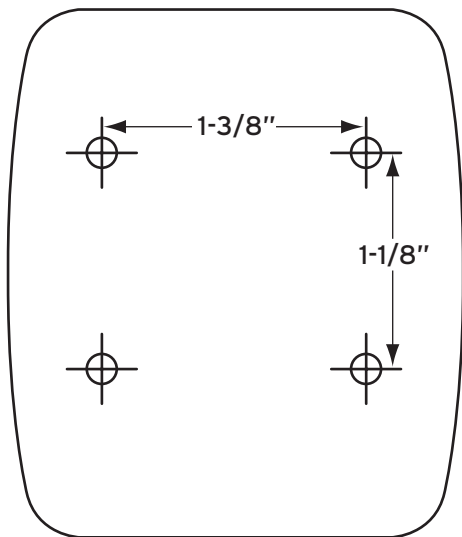



xmradio.com

SIRIUS XM Radio Inc.  
1221 Avenue of the Americas  
New York, NY 10020

1.800.967.2346

© 2010 SIRIUS XM Radio Inc.

XM Direct Home Tuner User Guide (XHD2KUG0809) 030710a



## Free Manuals Download Website

<http://myh66.com>

<http://usermanuals.us>

<http://www.somanuals.com>

<http://www.4manuals.cc>

<http://www.manual-lib.com>

<http://www.404manual.com>

<http://www.luxmanual.com>

<http://aubethermostatmanual.com>

Golf course search by state

<http://golfingnear.com>

Email search by domain

<http://emailbydomain.com>

Auto manuals search

<http://auto.somanuals.com>

TV manuals search

<http://tv.somanuals.com>