

Smart choice for power

xantrex

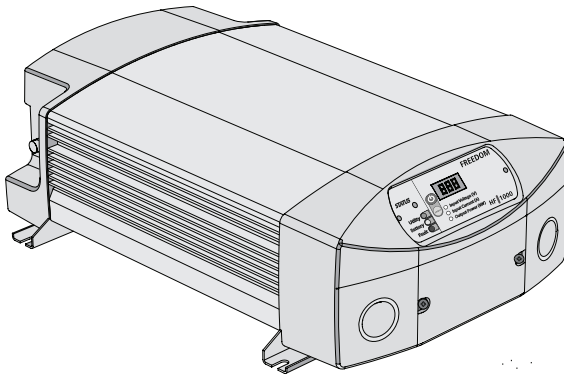

Owner's Guide

Freedom HW 1000 Inverter/Charger

www.xantrex.com

Freedom HW 1000 Inverter/Charger

Owner's Guide

About Xantrex

Xantrex Technology Inc. (www.xantrex.com), a subsidiary of Schneider Electric, is a world leader in the development, manufacturing and marketing of advanced power electronic products and systems for the renewable and mobile power markets. The company's products convert and control raw electrical power from any central, distributed, renewable, or backup power source into high-quality power required by electronic equipment and the electricity grid. Xantrex is headquartered in Vancouver, Canada, with facilities in the United States, Germany, Spain, and a joint venture in China.

About Schneider Electric

As a global specialist in energy management with operations in more than 100 countries, Schneider Electric offers integrated solutions across multiple market segments, including leadership positions in energy and infrastructure, industrial processes, building automation, and data centres/networks, as well as a broad presence in residential applications. Focused on making energy safe, reliable, and efficient, the company's 120,000 employees achieved sales of more than 17.3 billion euros in 2007, through an active commitment to help individuals and organizations "Make the most of their energy™".

Trademarks

Xantrex, Freedom, Smart Choice for Power, and Make the most of their energy are trademarks of Schneider Electric Services International sprl, registered in the U.S. and other countries.

Other trademarks, registered trademarks, and product names are the property of their respective owners and are used herein for identification purposes only.

Notice of Copyright

Xantrex Freedom HW Inverter/Charger Owner's Guide © December 2008 Xantrex Technology Inc. All rights reserved. No part of this document may be reproduced in any form or disclosed to third parties without the express written consent of: Xantrex Technology Inc., 5917-195th St NE, Arlington, WA 98223. Xantrex Technology Inc. reserves the right to revise this document and to periodically make changes to the content hereof without obligation or organization of such revisions or changes unless required to do so by prior arrangement.

Exclusion for Documentation

UNLESS SPECIFICALLY AGREED TO IN WRITING, XANTREX TECHNOLOGY INC. ("XANTREX")

(A) MAKES NO WARRANTY AS TO THE ACCURACY, SUFFICIENCY OR SUITABILITY OF ANY TECHNICAL OR OTHER INFORMATION PROVIDED IN ITS MANUALS OR OTHER DOCUMENTATION.

(B) ASSUMES NO RESPONSIBILITY OR LIABILITY FOR LOSSES, DAMAGES, COSTS OR EXPENSES, WHETHER SPECIAL, DIRECT, INDIRECT, CONSEQUENTIAL OR INCIDENTAL, WHICH MIGHT ARISE OUT OF THE USE OF SUCH INFORMATION. THE USE OF ANY SUCH INFORMATION WILL BE ENTIRELY AT THE USER'S RISK; AND

(C) REMINDS YOU THAT IF THIS MANUAL IS IN ANY LANGUAGE OTHER THAN ENGLISH, ALTHOUGH STEPS HAVE BEEN TAKEN TO MAINTAIN THE ACCURACY OF THE TRANSLATION, THE ACCURACY CANNOT BE GUARANTEED. APPROVED XANTREX CONTENT IS CONTAINED WITH THE ENGLISH LANGUAGE VERSION WHICH IS POSTED AT WWW.XANTREX.COM.

Date and Revision

December 2008 Rev A

Document Part Number

975-0467-01-01

Product Number

806-1055

Contact Information

Telephone: 1 800 670 0707 (toll free North America)
1 408 987 6030 (direct)

Fax: 1 800 994 7828 (toll free North America)

Email: customerservice@xantrex.com

Web: www.xantrex.com

About This Guide

Purpose

The purpose of this **Owner's Guide** is to provide explanations and procedures for operating, maintaining, and troubleshooting a **Freedom HW Installation***.

For complete information to help in setting up a **Freedom HW Installation** see the **Freedom HF Inverter/Charger Installation Guide (Doc. Part Number: 975-0468-01-01)**.

** Recreational or Fleet Vehicle installation.*

Scope

The **Guide** provides safety guidelines, as well as information about operating and troubleshooting the installation. It does not provide details about particular brands of batteries. You need to consult individual battery manufacturers for this information.

Audience

The **Guide** is intended for users and operators of the **Freedom HW Inverter/Charger** unit.

Organization

This **Guide** is organized into five chapters and one appendix.

Chapter 1 introduces you to the Freedom HW, explains the inverting, charging, and power system management functions.

Chapter 2 contains information and labeled illustrations to help identify the various features of the Freedom HW.

Chapter 3 explains how to configure the Freedom HW to best meet your electrical system requirements.

Chapter 4 explains how to operate the Freedom HW efficiently and effectively.

Chapter 5 describes how to troubleshoot the Freedom HW Inverter/Charger during operation.

Appendix A contains electrical performance information and product specifications.

Conventions Used

The following conventions are used in this guide.



WARNING

Warnings identify conditions or practices that could result in personal injury or loss of life



CAUTION

Cautions identify conditions or practices that could result in damage to the unit or other equipment.

Important: These notes describe things which are important for you to know, but not as serious as a caution or warning.

Related Information

You can find more information about Xantrex Technology Inc. as well as its products and services at www.xantrex.com

Important Safety Instructions

READ AND SAVE THIS **OWNER'S GUIDE** FOR FUTURE REFERENCE.

This chapter contains important safety and operating instructions for the **Freedom HW Inverter/Charger** unit.



WARNING: Limitations on use

The **Freedom HW** is not intended for use in connection with life support systems or other medical equipment or devices.

-
1. Before installing and using the **Freedom HW**, read all instructions and cautionary markings on the **Freedom HW**, the batteries, and all appropriate sections of this guide.



CAUTION: Risk of injury

To reduce the risk of injury, charge only 12 Vdc lead-acid (GEL, AGM, or Flooded) rechargeable batteries. Other battery types may burst, causing personal injury and damage.

-
2. Do not expose the **Freedom HW** to rain, snow, spray, or bilge water. To reduce risk of fire hazard, do not cover or obstruct the ventilation openings. Do not install the **Freedom HW** in a zero-clearance compartment. Overheating may result.
 3. To avoid a risk of fire and electric shock, make sure that existing wiring is in good condition and that wire is not undersized. Do not operate the **Freedom HW** with damaged or substandard wiring.
 4. The use of any attachments not recommended or sold by Xantrex, may result in risk of fire, electric shock, or injury to persons.
 5. Do not operate the **Freedom HW** if it has received a sharp blow, been dropped, or otherwise damaged in any way. If the **Freedom HW** is damaged, see the Warranty section.

6. Do not disassemble the **Freedom HW**. It contains no user-serviceable parts. See Warranty for instructions on obtaining service. Attempting to service the **Freedom HW** yourself may result in a risk of electrical shock or fire and will void your warranty. Internal capacitors remain charged after all power is disconnected.
7. To reduce the risk of electrical shock, disconnect both AC and DC power from the **Freedom HW** before attempting any maintenance or cleaning or working on any circuits connected to the **Freedom HW**. Turning off controls will not reduce this risk.
8. The **Freedom HW** must be provided with an equipment-grounding conductor connected to the AC input ground.



WARNING: Explosion hazard

1. Working in the vicinity of batteries is dangerous. Batteries generate explosive gases during normal operation. Therefore, it is of utmost importance that each time before servicing the unit in the vicinity of the battery, that you read this manual and follow the instructions exactly.
2. This equipment contains components which tend to produce arcs or sparks. To prevent fire or explosion, do not install the **Freedom HW** in compartments containing batteries or flammable materials, or in locations that require ignition-protected equipment. This includes any space containing gasoline-powered machinery, fuel tanks, as well as joints, fittings, or other connections between components of the fuel system.
3. To reduce the risk of battery explosion, follow these instructions and those published by the battery manufacturer and the manufacturer of any unit you intend to use in the vicinity of the battery.

Personal Precautions When Working With Batteries



WARNING: BATTERIES PRESENT RISK OF ELECTRICAL SHOCK, BURN FROM HIGH SHORT-CIRCUIT CURRENT, FIRE OR EXPLOSION FROM VENTED GASES. OBSERVE PROPER PRECAUTIONS.

1. Study and follow all of the battery manufacturer's specific precautions, such as removing or not removing cell caps while charging, and recommended rates of charge.
2. Add distilled water in each cell until battery acid reaches the level specified by the battery manufacturer. This helps to purge excessive gas from cells. Do not overfill. For a battery without cell caps, carefully follow manufacturer's recharging instructions.
3. Make sure the area around the battery is well ventilated.
4. Never smoke or allow a spark or flame near the engine or batteries.
5. Use extra caution to reduce the risk of dropping a metal tool on the battery. It could spark or short circuit the battery or other electrical parts and could cause an explosion.
6. Remove all metal items, like rings, bracelets, and watches when working with batteries. Batteries can produce a short circuit current high enough to weld metal to skin, causing a severe burn.
7. Have someone within range of your voice or close enough to come to your aid when you work near a lead-acid battery.
8. Have plenty of fresh water and soap nearby in case battery acid contacts skin, clothing, or eyes.
9. Wear complete eye protection and clothing protection. Avoid touching your eyes while working near batteries.

10. If battery acid contacts skin or clothing, wash immediately with soap and water. If acid enters your eye, immediately flood it with running cold water for at least twenty minutes and get medical attention immediately.
11. If you need to remove a battery, always remove the ground terminal from the battery first. Make sure all accessories are off so you don't cause an arc.
12. Never charge a frozen battery.
13. Clean battery terminals. Be careful to keep corrosion from coming into contact with your eyes.
14. Locate the **Freedom HW** unit away from batteries in a separate, well ventilated compartment.
15. Never place the **Freedom HW** unit directly above batteries; gases from a battery will corrode and damage the unit
16. Never allow battery acid to drip on the unit when reading gravity, or filling battery.
17. Do not operate the unit in a closed in area, or restrict the ventilation in any way.

DC CONNECTION PRECAUTION

18. Connect and disconnect DC output connections only after setting any recreational vehicle unit switches to off position and opening AC disconnect.
19. Proper disposal of batteries is required. Refer to your local codes for disposal requirements.

Precautions for Using Rechargeable Appliances



CAUTION: Equipment damage

Most rechargeable battery-operated equipment uses a separate charger or transformer that is plugged into an AC receptacle and produces a low voltage charging output.

Some chargers for small rechargeable batteries can be damaged if connected to the **Freedom HW**. Do not use the following with the **Freedom HW**:

- Small battery-operated appliances like flashlights, razors, and night lights that can be plugged directly into an AC receptacle to recharge.
- Some chargers for battery packs used in powerhand tools. These affected chargers display a warning label stating that dangerous voltages are present at the battery terminals.

Important: if you are unsure about using your rechargeable appliance with the **Freedom HW**, contact the equipment manufacturer to find out if the appliance is acceptable for use with modified sine wave input voltage. See the detailed description of the **Freedom HW** waveform in [Appendix A, “Specifications”](#) under [“Electrical Specifications: Inverter Mode”](#) on page A-2.

Contents

Important Safety Instructions	v
1 Introduction	
Freedom HW Inverter/Charger	1-2
Independent Power System	1-3
2 Features	
Materials List	2-2
Default Settings for the Freedom HW System	2-3
Front Panel	2-3
Side Panel	2-4
Rear Panel	2-4
Display Panel	2-5
3 Configuration	
Setting Battery Types on the Main Unit	3-2
Viewing Inverter/Charger Information	3-3
Adjusting Feature Settings	3-3
4 Operation	
Display Panel Operation	4-2
Operating in Shore Power Mode	4-3
Inverter Mode Settings	4-3
Operating in Inverter Mode	4-4
Disabling the Inverter Function	4-4
Checking Battery Status	4-4
Checking Output Power	4-4
Operating Several Loads at Once	4-5
Adjusting the Audible Alarm	4-5
Status LED During Inverter Mode	4-6
Operating During Transition Between Shore Power and Inverter Mode	4-8
Transitioning from Shore Power to Inverter Mode	4-8
Transitioning from Inverter Mode to Shore Power	4-8

Operating Limits	4-9
Power Output	4-9
Input Voltage	4-9
Inverter Loads	4-10
Overload Conditions	4-10
High Surge Loads	4-10
Trouble Loads	4-11
Over-temperature Conditions	4-11
Battery Charging	4-12
Routine Maintenance	4-14
Freedom HW Unit	4-14
Batteries	4-14

5 Troubleshooting

General Troubleshooting Guidelines	5-2
Common Problems	5-4
Buzz in Audio Equipment	5-4
Television Reception	5-4
Warning Messages	5-5
Troubleshooting Reference	5-8
Inverter Applications	5-10
Resistive Loads	5-10
Motor Loads	5-11
Long Transfer Times	5-11
High Surge When Powering Incandescent and CFL Bulbs	5-11

A Specifications

Electrical Specifications: Inverter Mode ----- A-2
Electrical Specifications: Charge Mode ----- A-3
Environmental Specifications ----- A-4
System Specifications ----- A-4
Physical Specifications ----- A-4
Regulatory Approvals ----- A-5
Inverter Overload Operation----- A-5
Invert Power Derating vs. Ambient Temperature ----- A-6
Charger Output Current vs. AC Input Voltage ----- A-7

Warranty and Return Information ----- WA-1

Figures

Figure 2-1	What's In The Box	2-2
Figure 3-1	Dip Switches (Factory Setting Shown)	3-2
Figure 3-2	Display Panel	3-3
Figure 4-1	Three-stage Charging Process	4-12

Tables

Table 2-1	Freedom HW Default Values -----	2-3
Table 3-1	Charging Current Guidelines-----	3-5
Table 4-1	Status LED during Inverter Mode -----	4-6
Table 4-2	Battery Charging Status LED -----	4-13
Table 4-3	Battery Charging Voltage and Current Settings -----	4-14
Table 5-1	Error Codes Displayed on the Display Panel Screen -----	5-5
Table 5-2	Troubleshooting Reference-----	5-8
Table A-1	Charging Voltage -----	A-7

1

Introduction

Chapter 1 introduces you to the **Freedom HW**, explains the inverting, charging, and power system management functions.

It covers the following:

- **Freedom HW**'s major features, and
- **Freedom HW**'s function as an independent power system.

Freedom HW Inverter/Charger

Congratulations on your purchase of the **Freedom HW Inverter/Charger (Freedom HW)**. As part of the Xantrex Inverter/Charger family, the **Freedom HW** gives you quality power, worry-free operation, and outstanding reliability. The **Freedom HW**'s integrated inverting–charging functions and numerous power management features make it ideal for recreational and commercial vehicles.

Quality Power

The **Freedom HW** provides up to 1000 watts of continuous modified sine wave power from a battery bank. It is designed to handle loads such as a 600-watt microwave, TVs, VCRs, and midsized power tools.

The **Freedom HW**'s high surge capability lets you handle many hard-to-start loads, including large TVs and small refrigerators.

The built-in transfer switch automatically transfers between inverter power and incoming AC power (shore power) to ensure power is always available.

The built-in charger automatically charges the battery bank when the **Freedom HW** is connected to incoming AC power (shore power).

Comprehensive Protection

The **Freedom HW**'s built-in protection features safeguard your batteries and equipment to give you worry-free operation:

- The **low battery voltage alarm and shutdown** prevents your batteries from becoming completely discharged.
- The **three-stage charging capability** ensures that batteries receive the “best” charge with minimal wear and tear.
- If the **Freedom HW** detects low AC voltage, it **switches automatically** to Inverter mode and supplies your equipment with modified sine wave power derived from the batteries. When AC voltage returns within range again, the **Freedom HW** allows the AC to pass through to your loads and automatically begins to recharge the batteries.

Reliable Back-up

If incoming shore power fails, the **Freedom HW** automatically detects the failure and instantly becomes an independent power source that supplies quality AC to your loads.

Overload Alarm and Shutdown

During Inverter mode, the **Freedom HW** automatically alerts you if the loads that are connected and drawing power from the unit are close to the maximum operating limit.

The **Freedom HW** automatically shuts down when the maximum operating limit is exceeded.

Over-temp Alarm and Shutdown

During Inverter mode, the **Freedom HW** automatically alerts you if it is overheating and approaching the over-temperature shutdown limit.

The **Freedom HW** automatically shuts down when the limit is exceeded.

Independent Power System

Your **Freedom HW** has been designed to be the heart of a sophisticated, independent power system. While the **Freedom HW** is an extremely “friendly” product to operate, Xantrex wants to ensure that you get the best performance from your system.

Inverting

Freedom HW produces 120 Vac from your 12V batteries and is capable of starting heavy loads like refrigerators and pumps.

When the **Freedom HW** is inverting (producing 120 Vac output) without a load, it draws less than 1A of current from the battery (or battery bank).

This feature allows the unit to operate without draining too much stored energy.

Charging

For the inverter to perform effectively, the batteries must be charged correctly. The unit has a built-in three-stage charging system that extends the life and optimizes the performance of the batteries.

In addition to the numerous features which let you maximize your battery’s life and performance, the **Freedom HW**—unlike many chargers—also has the ability to recharge batteries even if the voltage is near zero (sometimes called dead battery charging).

2

Features

Chapter 2 contains information and labeled illustrations to help identify the various features of the **Freedom HW**.

It covers the following:

- Materials list,
- Default settings list,
- Front panel features,
- Side panel features,
- Rear panel features, and
- Display panel features

Materials List

Your **Freedom HW Inverter/Charger** package includes the items listed below.

- **Freedom HW Inverter/Charger** unit
- display panel (p/n: 808-9557) with 7-inch (0.17 m) display panel cable (p/n: 053-0049-02)
- display panel mounting plate (p/n: 808-9555)
- display panel mounting template (p/n: 531-0081-01-01)
- display panel compartment cover (p/n: 808-9556)
- AC wiring compartment cover (p/n: 210-0738-01-01)
- two reference materials—an Owner's Guide and an Installation Guide (p/n: 975-0468-01-01 and 975-0467-01-01)
- one set of lock washers and nuts (already connected to the bolts) (p/n: 061-2002 and 062-0030)

Freedom HW unit

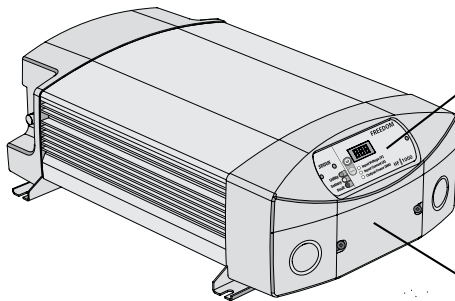

Display panel is already mounted on the unit and connected to the remote panel port using the 7-inch display panel cable. Underneath is the display panel compartment that houses the remote panel port and the remote dip switch.

Wiring compartment cover.

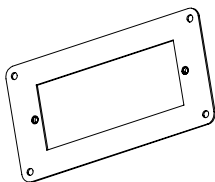

Display panel mounting plate

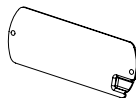

Display panel compartment cover

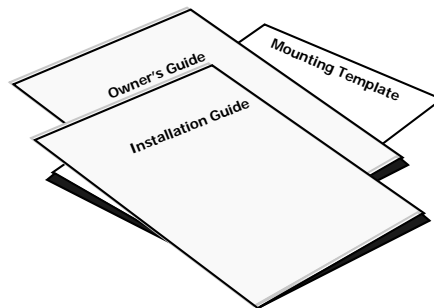

Figure 2-1 What's In The Box

Default Settings for the Freedom HW System

Table 2-1 lists the default settings for the Freedom HW system.

You may record your settings in the right-hand column after you have configured the Freedom HW.

Table 2-1 Freedom HW Default Values

Item	Default Setting	Your Setting
Alarm*	ON	
Charger Current*	55A	
Battery Type **	Flooded(14.4/13.5)	

* adjustable from the display panel.

** adjustable from the main unit behind the display panel assembly.

Front Panel

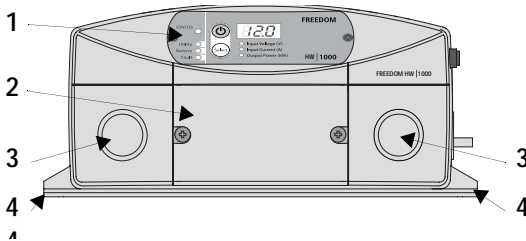

Feature	Description
1	Display panel displays inverter status and battery status information on the screen. The panel can be detached to expose the dip switches behind it and to extend and mount the panel on a wall or other location.
2	Wiring compartment cover can be removed to access the AC wiring compartment for hard wiring the inverter to an existing AC power system.
3	Knockouts for routing AC input and output wiring in hard wired installations.
4	Mounting flange allows you to mount the inverter permanently.

Side Panel

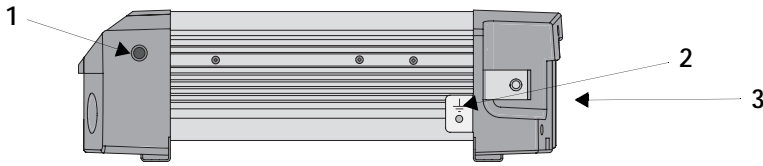

Feature	Description
1	30 A supplementary protector provides overload protection for the AC output.
2	Grounding stud provides a ground path for the Freedom HW chassis to the DC system ground.
3	Main cooling fan turns on when powering loads above 500 W or when the internal temperature reaches a set point temperature.

Rear Panel

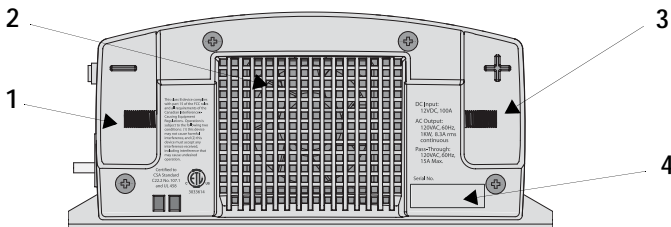

Feature	Description
1	Negative DC cabling terminal connects to the negative terminal of the battery using a battery cable.
2	Ventilation grille (openings) must not be obstructed for the proper operation of the cooling fan and inverter. When the inverter is mounted, the ventilation grille must not point up or down.
3	Positive DC cabling terminal connects to the positive terminal of the battery using a battery cable.
4	Serial number of your unit.

Display Panel

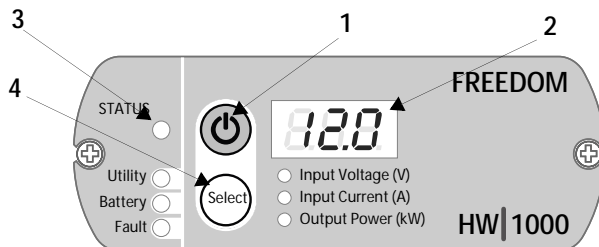

Feature	Description
1	Power button is the main unit switch that turns the Freedom HW 's inverter function ON or OFF and is also used to select unit feature settings. See page 4-2 for additional information.
2	Three-digit LED display screen shows status information and fault codes. See page 4-2 for additional information.
3	Status LED indicates the mode of operation with a three-color LED. See page 4-2 for additional information.
4	Select button changes status information displayed on the display screen and is also used to select unit feature settings. See page 4-2 for additional information.
<p>IMPORTANT: See Chapter 4, "Display Panel Operation" starting on page 4-2 for detailed information on operating the panel's buttons.</p>	

3

Configuration

Chapter 3 explains how to configure the **Freedom HW** to best meet your electrical system requirements.

It covers the following:

- Setting battery types on the main unit and
- Adjusting unit settings.

Setting Battery Types on the Main Unit

You can attach different types of lead-acid batteries to the **Freedom HW**. Before installing batteries make sure that you configure the unit to optimize the charging process.



WARNING: Fire hazard

Incorrectly setting the battery type can lead to battery damage and a risk of fire.

The settings can be changed by adjusting the dip switches found on the main unit behind the display panel.

Battery Type	Dip Switch Setting Switch 1 Switch 2	Bulk/Absorption	Float
Fixed	OFF OFF	13.5	13.5
Flooded	OFF ON (factory setting)	14.4	13.5
GEL	ON OFF	14.2	13.8
AGM	ON ON	14.3	13.4

To adjust the battery type setting:

By default (factory setting) the battery type is set to Flooded (OFF|ON).

1. Detach the Display Panel to expose the Dip Switches.
2. Use the tip of your fingernail or a small screw driver with a flat tip to adjust the switches.

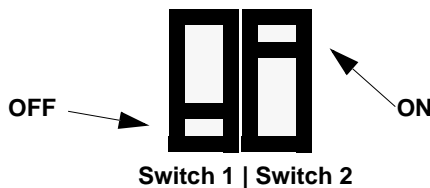

Figure 3-1 Dip Switches (Factory Setting Shown)

Viewing Inverter/Charger Information

The LED screen displays inverter/charger information as well as feature settings in coordination with the LED lights underneath the screen.

- ◆ Press the Select button to toggle between the following information:

Info and Setting	LED Screen	Info and Settings LED
DC Input Voltage	<i>12.8</i> (example)	Solid – Input Voltage (V)
DC Input Current	<i>11</i> (example)	Solid – Input Current (A)
AC Output Power	<i>0.85</i> (example)	Solid – Output Power (kW)
Charging Current Setting	<i>5A</i> or <i>15A</i> or <i>35A</i> or <i>55A</i>	none
Inverter Mode Setting	<i>1 n 0</i> or <i>1 n 1</i>	none
Alarm Setting	<i>AL 0</i> or <i>AL 1</i>	none
Low Voltage Setting	<i>5dL</i> or <i>5dH</i>	none

Adjusting Feature Settings

The Power and Select buttons can be used to:

- change the charging current setting,
- change the inverter mode setting,
- disable or enable the audible alarm,
- change the shutdown setting, and
- return to factory default settings.

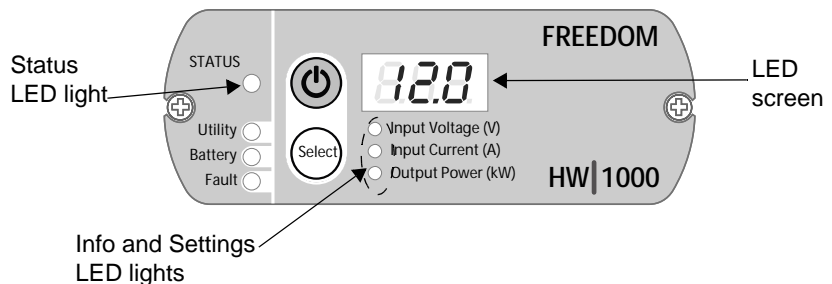

Figure 3-2 Display Panel

To cycle through the various feature settings:

1. Press and hold the Power button for five seconds to enter the feature settings mode.
2. Press the Power button to toggle between the following information:

Setting	LED Screen
Charging Current Setting	<i>CUr</i>
Inverter Mode Setting	<i>In</i>
Alarm Setting	<i>AL</i>
Shutdown Setting	<i>Sd</i>
Factory Setting	<i>dEF</i>

To change the charger's charging current setting:

By default the charging current is set to 55 A.

1. Press and hold the Power button for five seconds.
The LED screen will flash "*CUr*" intermittently.
2. Press the Select button once.
The LED screen will display the present charging current setting. Example, "*55A*" for a 55 A setting.
3. Press the Select button again to change to the next setting.
The LED screen shows the next setting. Example, "*5A*" for a 5 A setting.
4. Continue pressing the Select button to cycle through each of the four settings – "*5A*", "*15A*", "*35A*", and "*55A*" until you reach the desired setting.
5. Press and hold the Select button for five seconds to make the setting permanent.

Table 3-1 Charging Current Guidelines

AC Input Circuit Breaker or fuse size (Amps)	Charger DC Current Setting (Amps)	Maximum By-pass AC Current Available (Amps)
15	5	12.5
	15	9.5
	35	4.0
	55	0
20	5	17.5
	15	14.5
	35	9.0
	55	5.0
30	5	27.5
	15	24.5
	35	19.0
	55	15.0

To change the inverter mode setting:

By default the inverter mode is set to ON.

ON (“I n I”) will put the inverter on standby. This means when shorepower is present, AC shorepower will pass through as AC output. And when shorepower is not available, the inverter function will take power from the battery and provide AC output power. When the inverter mode is ON, you can manually turn the inverter function ON or OFF by using the Power button. See [“Operating in Inverter Mode” on page 4-4](#).

OFF (“I n 0”) will completely disable inverter function. This means when shorepower is present, AC shorepower will still pass through as AC output. However, when shorepower is not available, the inverter function remains disabled and therefore no AC output power. When the inverter mode is OFF, you cannot manually turn the inverter function ON or OFF by using the Power button.

1. Press and hold the Power button for five seconds.
2. Press the Power button once.
3. Press the Select button once.

The LED screen will flash “I n” intermittently.

The LED screen will display the present (or most recent) inverter mode setting.

Example, “I n I” for an inverter mode setting of ON or “I n 0” for an inverter mode setting of OFF.

-
4. Continue pressing the Select button to cycle through the two settings – “**AL I**” and “**AL 0**” until you reach the desired setting.
 5. Press and hold the Select button for five seconds to make the setting permanent.

To adjust the alarm setting:

By default the alarm is set to ON.

ON (“**AL I**”) will sound the alarm on all warning and fault conditions.
OFF (“**AL 0**”) will mute the alarm.

1. Press and hold the Power button for five seconds.
2. Press the Power button twice.
The LED screen will flash “**AL**” intermittently.
3. Press the Select button once.
The LED screen will display the present (or most recent) alarm setting.
Example, “**AL I**” for an inverter mode setting of ON.
4. Continue pressing the Select button to cycle through the two settings – “**AL 0**” and “**AL I**” until you reach the desired setting.
5. Press and hold the Select button for five seconds to make the setting permanent.

To adjust the under voltage shutdown setting:

By default the low voltage setting is set to Low.

Low (“**SdL**”) sets the under voltage shutdown threshold to 10.5 V.
High (“**SdH**”) sets the under voltage shutdown threshold to 11.8 V.

1. Press and hold the Power button for five seconds.
2. Press the Power button three times.
The LED screen will flash “**Sd**” intermittently.
3. Press the Select button once.
The LED screen will display the present (or most recent) low voltage setting.
Example, “**SdL**” for a low shutdown voltage setting.
4. Continue pressing the Select button to cycle through the two settings – “**SdH**” and “**SdL**” until you reach the desired setting.
5. Press and hold the Select button for five seconds to make the setting permanent.

To return all feature settings to factory default settings:

1. Press and hold the Power button for five seconds.
2. Press the Power button four times.
The LED screen will flash “**DEF**” intermittently.
3. Press and hold the Select button for five seconds to return all feature settings to their factory default settings.

4

Operation

Chapter 4 explains how to operate the Freedom HW efficiently and effectively.

It covers the following:

- Procedures for operating the inverter from the display panel,
- Operating limits and inverter loads,
- Battery charging, and
- Information about routine maintenance.

Display Panel Operation

The **Freedom HW** features a display panel with three-digit LED display screen to show inverter, AC source, and battery status information.

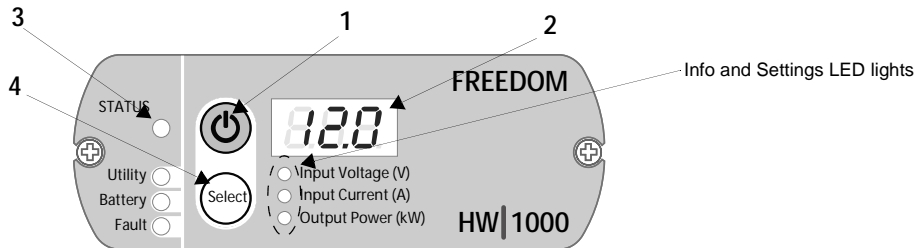

Feature	Description
1	<p>Power button</p> <ul style="list-style-type: none"> Press and hold for one second to turn the Freedom HW's Inverter function ON or OFF (when AC Shore Power is NOT present.) Press and hold for five seconds to go into Feature Setting Mode.
2	<p>Three-digit LED display screen shows status information and fault codes.</p>
3	<p>Status LED – indicates the mode of operation with a three-color LED.</p> <ul style="list-style-type: none"> Green pertains to Utility status. <ul style="list-style-type: none"> Solid indicates the Freedom HW is in shore power mode and battery is fully charged. Flashing indicates the Freedom HW is in shore power mode and the unit is currently charging the battery. Yellow pertains to Battery status. <ul style="list-style-type: none"> Solid indicates the Freedom HW is in inverter mode and using the battery to provide AC power. Flashing indicates the Freedom HW is in inverter mode but AC shore power is detected thus transferring to shore power mode within 20 seconds. Red indicates a Fault condition and the Freedom HW has shut down. See “Troubleshooting Reference” on page 5–8.
4	<p>Select button</p> <ul style="list-style-type: none"> In Invert mode, press the button to choose what appears in the three-digit LED display. See “Viewing Inverter/Charger Information” on page 3–3. NOTE: A corresponding LED light either flashes or illuminates solid for each item. In Feature setting mode, press to toggle through different selections and press and hold for five seconds to make the selection permanent. See “Adjusting Feature Settings” on page 3–3.

Operating in Shore Power Mode

The **Freedom HW** operates in shore power mode when an AC source (a generator or utility power) is present at the AC input terminals. When the AC source is within operating range, the **Freedom HW** unit bypasses inverter function and provides the same AC source power to the AC output terminals. AC power will automatically pass through the **Freedom HW**.



WARNING: Shock hazard

Switching the Power button to Standby does not interrupt the supply of shore power to the **Freedom HW**. Shore power supersedes inverter function. See “[Transitioning from Inverter Mode to Shore Power](#)” on page 4–8.

The **Freedom HW** also automatically charges the battery bank that is connected while in shore power mode. See “[Battery Charging](#)” on page 4–12.

The green Status LED lights up to indicate that the **Freedom HW** is using utility (or generator) power and the battery is full. A flashing green Status LED indicates that the unit is charging the battery.

Inverter Mode Settings

Inverter mode setting is Standby When the **Freedom HW**'s Inverter mode setting is enabled (“**I n I**”) and the AC source is outside the operating range or is disconnected, the transfer switch automatically switches to inverter function. This means that the AC output terminals will provide power from the battery and any appliance connected to the AC output terminals will operate.

Inverter mode setting is Off When the **Freedom HW**'s Inverter mode setting is disabled (“**I n 0**”) and the AC source is outside the operating range or is disconnected, the **Freedom HW** will not switch to invert mode. This means that even if the Power button is pressed to try and turn inverter function on, there will be no power coming from the battery to the AC output terminals. Therefore, any appliance connected to the AC output terminals will not operate.

Note: To configure see “[To change the inverter mode setting:](#)” on page 3–5.

Operating in Inverter Mode

The **Freedom HW** is in inverter mode when shore power is not presently available and the unit is using the battery (inverting DC to AC) to power the appliances connected to the **Freedom HW**.

The Yellow status LED lights up to indicate the **Freedom HW** is using the battery to power the appliances.

[Table 4-1](#) below illustrates the battery status during inverter mode as shown on the display panel.

Disabling the Inverter Function



WARNING: Shock hazard

Switching the Power button to Off does not disconnect DC battery power from the **Freedom HW**. You must disconnect both AC and DC power before working on any circuits connected to the **Freedom HW**.

To prevent unnecessary battery discharge, switch the Power button to Off when you are not using the **Freedom HW**.

Checking Battery Status

During inverter mode, you can check the battery status by pressing the Select button until the Input Voltage LED (or Input Current LED) illuminates. The battery voltage (or battery current) appears in the three-digit LED display screen when the Input Voltage LED (or Input Current LED) illuminates.

The normal operating battery voltage range is between 11 and 15 volts.

Checking Output Power

During Inverter mode, you can check how much power (displayed in kW) the **Freedom HW** is supplying to the connected loads by pressing the Select button until the Output Power LED illuminates.

Operating Several Loads at Once

If you are going to operate several loads from the **Freedom HW**, turn them on one at a time after you have turned the inverter on.

Turning loads on separately helps to ensure that the inverter does not have to deliver the starting current for all the loads at once, and will help prevent an overload shutdown.

Adjusting the Audible Alarm

The **Freedom HW**'s audible alarm can be enabled or disabled. See [“To adjust the alarm setting:”](#) on page 3–6.

Any warnings such as fault conditions or imminent shutdown are both displayed on the display panel's screen and sounded on the alarm speakers. It is not possible to turn OFF the screen and prevent it from displaying error codes but it is possible to turn OFF the audible alarm.

Status LED During Inverter Mode

The following summarizes the behavior of the Status LED during Inverter mode.

Table 4-1 Status LED during Inverter Mode

Status LED	Display Screen	Condition
Solid YELLOW	12.8 (where 12.8 is an example of battery voltage)	Select button is pressed to display Input Battery Voltage. The Input Battery Voltage LED lights up. Value in display screen is shown as Volts.
	11 (where 11 is an example of current)	Select button is pressed to display Input Current. The Input Current LED lights up. Value in display screen is shown as Amps.
	0.85 (where 0.85 is an example of output power in Kilowatts)	Select button is pressed to display Output Power. The Output Power LED lights up. Value in display screen is shown as Kilowatts.
	5A or 15A or 35A or 55A	Select button is pressed to display present Charging Current setting. None of the info and setting LED lights are on. Present setting is displayed on the screen.
	1 n0 or 1 n 1	Select button is pressed to display present Inverter Mode setting. None of the info and setting LED lights are on. Present setting is displayed on the screen.
	AL0 or AL 1	Select button is pressed to display present Alarm setting. None of the info and setting LED lights are on. Present setting is displayed on the screen.
	5dL or 5dH	Select button is pressed to display present Shutdown setting. None of the info and setting LED lights are on. Present setting is displayed on the screen.
	E05 through E07	Warning condition detected while AC output power is still available. See Table 5-1, “Error Codes Displayed on the Display Panel Screen” on page 5-5.

Table 4-1 Status LED during Inverter Mode

Status LED	Display Screen	Condition
Solid RED	<i>EO1</i> through <i>EO4</i>	Fault condition detected and AC output power is not available. The unit will sound an alarm and will shutdown completely within 30 seconds. See Table 5-1, “Error Codes Displayed on the Display Panel Screen” on page 5-5.
Off	Off	Inverter is OFF.
Off (or Yellow)	<i>00.0</i>	No communication between the Freedom HW and the Display Panel because the battery voltage was too low to start the Inverter.

Operating During Transition Between Shore Power and Inverter Mode

The **Freedom HW**'s advanced power management is capable of transitioning power from an AC source to DC source within a fraction of a second and vice-versa.

The **Freedom HW** automatically detects when shore power is present and when it becomes unavailable or when shore power drops to less than 95 Vac.

Transitioning from Shore Power to Inverter Mode

When the unit is operating in shore power mode and shore power is lost, the **Freedom HW** has less than 30 ms (milliseconds) to switch to inverter mode and start drawing power from the battery.

The Status LED will turn from solid or flashing GREEN to a solid YELLOW.

Transitioning from Inverter Mode to Shore Power

When the unit is operating in inverter mode and shore power becomes available, the **Freedom HW** begins a 20-second countdown to verify the stability of the shore power. If shore power remains stable within 20 seconds, at the end of the countdown, the **Freedom HW** has less than 30 ms (milliseconds) to switch to shore power mode and start drawing power from the AC source.

The Status LED will turn from solid YELLOW to flashing YELLOW during the 20-second countdown, then turn to GREEN when battery power is transitioned successfully to shore power.

Operating Limits

Power Output

The **Freedom HW** can deliver up to 1000 watts continuous power. The wattage rating applies to resistive loads such as incandescent lights.

Input Voltage

The allowable **Freedom HW** input voltage ranges are shown in the following table:

Operating Condition	Voltage Range	Comment
Normal	11–15.0 V	
Optimum Performance	12.0–13.0 V	
Low Voltage Alarm “ SdL ” low setting “ SdH ” high setting	11.0 V or less 12.3 V or less	The low battery alarm beeps once every two seconds and the display shows fault code E05 .
Low Voltage Shutdown “ SdL ” low setting “ SdH ” high setting	10.5 V or less 11.8 V or less	The low battery alarm beeps every second and the display shows fault code E01 . The status LED turns red and the display screen is turned OFF within 30 seconds to protect the battery from being over-discharged.
High Voltage Shutdown “ SdL ” low setting “ SdH ” high setting	15.5 V or more 12.6 V or more	The over-voltage alarm beeps every second and the display shows fault code E02 alternating with the battery voltage. The status LED turns red and the display screen is turned OFF within 30 seconds to protect itself from excessive input voltage. Note: Although the Freedom HW incorporates over-voltage protection, it can still be damaged if input voltage exceeds 16 V.

Inverter Loads

The **Freedom HW** will operate most AC loads within its power rating of 1000 watts. However, some appliances and equipment may be difficult to operate, and other appliances may actually be damaged if you try to operate them with the **Freedom HW**. Please read “**High Surge Loads**” and “**Trouble Loads**” carefully.

Overload Conditions

There are two kinds of overload conditions:

- An overload warning and
- An overload shutdown.

Overload
Warning

When the **Freedom HW**'s AC load is approximately 100 W below the overload shutdown limit of ~1000 W, the audible alarm beeps once every two seconds and the display screen shows a fault code **E05**.

Overload
Shutdown

When the **Freedom HW**'s AC load increases to near ~1100 W, the audible alarm beeps every second and the display screen shows a fault code **E03**. The Status LED turns solid RED and in 30 seconds, both the unit and the display screen will shut down to prevent damage to the inverter and protect the battery from being over-discharged.

High Surge Loads

Some induction motors used in freezers, pumps, and other motor-operated equipment require high surge currents to start. The **Freedom HW** may not be able to start some of these motors even though their rated steady state current draw is within the inverter's limits. The unit will shut down and indicate an overload shutdown.

A single incandescent bulb requires five to ten times its power rating when lighting up from a cold start. If you have several bulbs lighting up all at the same time, then the surge is even greater.

A Compact Fluorescent Light or CFL also has a momentary surge that is more than ten times its power rating when lighting up from a cold start.

Trouble Loads



CAUTION

Some equipment may be damaged by the **Freedom HW**'s modified sine wave output, which has a different wave form than utility-supplied electricity.

Some appliances, including the types listed below, may be damaged if they are connected to the **Freedom HW**:

- Speed controllers found in some fans, power tools, kitchen appliances, and other loads may be damaged.
- Some chargers for small rechargeable batteries can be damaged. See “[Precautions for Using Rechargeable Appliances](#)” on page ix for details.
- Metal halide arc (HMI) lights can be damaged.

Important: If you are unsure about operating any device with the **Freedom HW**, contact the manufacturer of the device to ensure that it is compatible with the modified sine waveform.

Over-temperature Conditions

During Inverter mode, when the **Freedom HW**'s internal temperature starts to approach its preset shutdown limit, the alarm will beep every two seconds and the display will show fault code $E07$. If the over-temperature condition persists, the alarm will beep once per second and the display will show fault code $E04$. The Status LED turns solid RED and the inverter will shut down to prevent damage to the inverter and protect the battery from being over-discharged. However, when the internal temperature drops and falls within normal operating temperature, the **Freedom HW** will recover automatically and will continue inverting.

During AC shore power mode, when the **Freedom HW**'s charger temperature starts to approach its threshold limit, the charging current will automatically derate from 55 A to 35 A. If the temperature continues to rise, the unit will shut down and resume operation when the unit temperature has cooled down.

The **Freedom HW** also monitors the internal transfer relay temperature. It automatically turns on the fan when the relay starts to approach its preset temperature limit and turns off when it cools down. If the relay exceeds its preset temperature limit, the display shows a fault code $E11$. See “[To reset error codes E10 to E12:](#)” on page 5–7.

Battery Charging

Battery charging is possible only when shore power is present and the **Freedom HW** unit is connected to a battery (or battery bank).

The frequency of battery charging is determined by how much energy in the battery is used up during inverting. Whenever the **Freedom HW** detects a battery voltage that falls below 12.8 Vdc, the unit will begin charging the battery, i.e., enter into bulk and absorption stages then settle in float stage. If battery voltage does not reach 5 Vdc after 1 minute or 10 Vdc after 15 minutes as shown in the graph, the unit will terminate the charging process and the error code $E 12$ will show on the display screen.

Figure 4-1 below illustrates the three-stage charging process used to maximize **Freedom HW**'s charging efficiency.

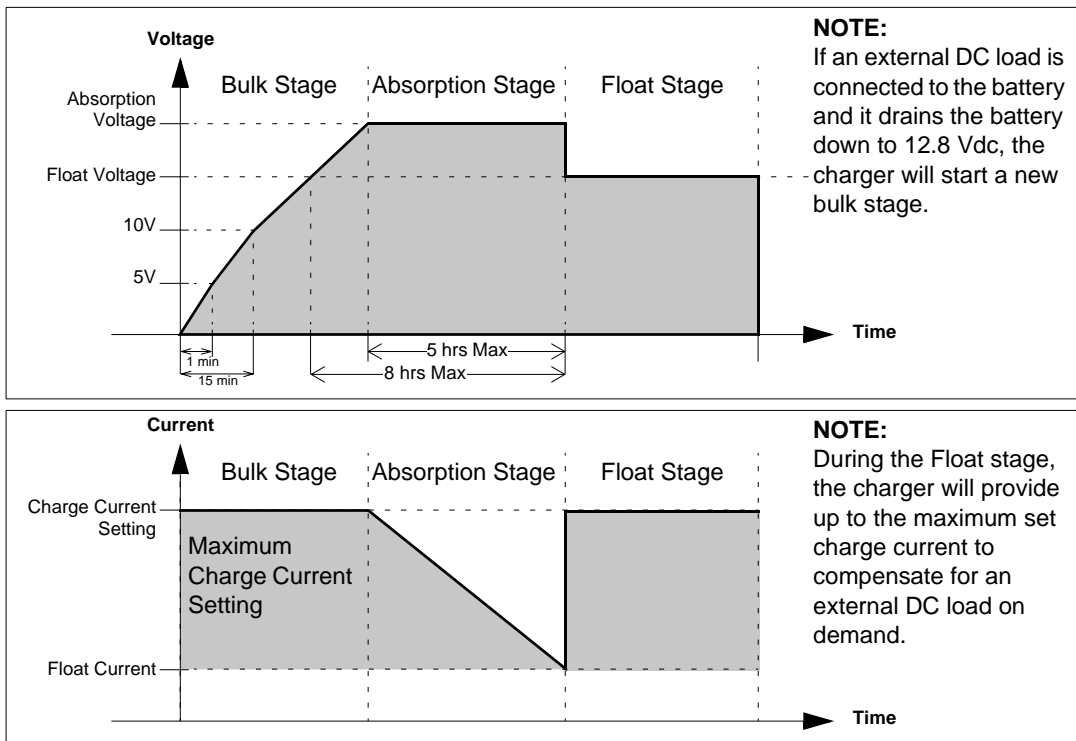

Figure 4-1 Three-stage Charging Process

Table 4-2 below illustrates the battery charging status as shown on the Status LED and display screen.

Table 4-2 Battery Charging Status LED

Status LED	Display Screen	Condition
Solid GREEN	FUL	Battery is FULL.
Flashing GREEN	bUL — CH9 — 12.8 (where 12.8 is an example of battery voltage)	Battery is in BULK CHARGE.
	AbS — CH9 — 14.2 (where 14.2 is an example of battery voltage)	Battery is in ABSORPTION CHARGE.
Solid RED	E 10 to E 12	See Table 5-1, “Error Codes Displayed on the Display Panel Screen” on page 5-5.
Solid GREEN or Flashing GREEN	SA or ISA or SSA or SSA	Select button is pressed to display present Charging Current setting. None of the info and setting LED lights are on. Present setting is displayed on the screen.
	IN0 or IN1	Select button is pressed to display present Inverter Mode setting. None of the info and setting LED lights are on. Present setting is displayed on the screen.
	AL0 or AL1	Select button is pressed to display present Alarm setting. None of the info and setting LED lights are on. Present setting is displayed on the screen.
	SDL or SDH	Select button is pressed to display present Shutdown setting. None of the info and setting LED lights are on. Present setting is displayed on the screen.

Table 4-3 below illustrates the battery charging voltage and current settings.

Table 4-3 Battery Charging Voltage and Current Settings

Battery Type	Bulk/Absorption Voltage (Volts)	Float Voltage (Volts)	Charge Current (Amps)	Float Current (Amps)
Flooded	14.4	13.5	5, 15 35, 55	1.5 4.5
GEL	14.2	13.8	5, 15 35, 55	1.5 4.5
AGM	14.3	13.4	5, 15 35, 55	1.5 4.5
Fixed	13.5	13.5	5, 15, 35, 55	not applicable

Routine Maintenance

Freedom HW Unit

Minimal maintenance is required to keep your **Freedom HW** operating properly. Periodically you should:

- Clean the exterior of the unit with a damp cloth to prevent the accumulation of dust and dirt.
- Ensure that the DC cables are secure and fasteners are tight.
- Make sure the ventilation openings are not clogged.

Batteries

When possible, you should recharge your batteries whenever a low voltage warning or a shutdown occurs with the **Freedom HW**. This gives the batteries a much longer life than recharging when the batteries have been almost completely discharged.

5

Troubleshooting

Chapter 5 describes how to troubleshoot the **Freedom HW Inverter/Charger** during operation.

It covers the following:

- General troubleshooting guidelines,
- Common problems,
- Warning messages,
- Troubleshooting references, and
- Inverter applications (loads).

General Troubleshooting Guidelines



WARNING: Shock and Energy hazard

Do not disassemble the **Freedom HW**. It does not contain any user-serviceable parts. Attempting to service the unit yourself could result in an electrical shock or burn.

Important: If you need to obtain service, see [page WA-1](#). Before you call Xantrex Customer Service, record the information that is asked for in “[Information About Your System](#)” on [page WA-5](#).

This section will help you narrow down the source of any problem you encounter. Before contacting Xantrex, please work through the steps listed below:

1. Check for any error codes displayed on the display screen. If a message is displayed, record it before doing anything further.
2. As soon as possible, record (on [page WA-3](#)) the conditions at the time the problem occurred so you can provide details when you contact customer service for help. Include the following as well as details noted on [page WA-5](#):
 - What loads the **Freedom HW** was running or attempting to run
 - What the battery condition was at the time (voltage, state of charge, etc.) if known
 - Recent sequence of events
 - Any known unusual AC shore power factors such as low voltage, unstable generator output, etc.
 - Whether any extreme ambient conditions existed at the time (temperature, vibrations, moisture, etc.)

3. If your **Freedom HW** is not displaying an error code, check the following to make sure the present state of the installation allows proper operation:
 - Is the inverter located in a clean, dry, adequately ventilated place?
 - Are the battery cables adequately sized as recommended in the Installation guide?
 - Is the battery in good condition?
 - Are all DC connections tight?
 - Are the AC input and output connections and wiring in good condition?
 - Are the configuration settings correct for your particular installation?
 - Are the display panel and the communications cable properly connected and undamaged?
 - Are all disconnects and AC breakers closed and operable?
 - Have any of the fuses blown in the installation?
4. Contact Xantrex for further assistance. Please be prepared to describe details of your system installation and to provide the model and serial number of the unit.

Common Problems

Buzz in Audio Equipment

Some inexpensive stereo systems may emit a buzzing noise from their loudspeakers when operated from the **Freedom HW**. This occurs because the power supply in the audio system does not adequately filter the modified sine wave produced by the inverter. The only solution is to use a sound system that has a higher quality power supply.

Television Reception

When the **Freedom HW** is operating, it can interfere with television reception on some channels. If interference occurs, try the following:

1. Make sure that the chassis ground stud on the **Freedom HW** is solidly connected to the ground system of your vehicle or vessel.
2. Make sure that the television antenna provides an adequate (“snow-free”) signal, and that you are using good quality cable between the antenna and the television.
3. Keep the cables between the battery and the **Freedom HW** as short as possible, and twist them together with two to three twists per foot. (This minimizes radiated interference from the cables.)
4. Move the television as far away from the **Freedom HW** as possible.
5. Do not operate high power loads with the **Freedom HW** while the television is on.

Warning Messages

Warning messages in the form of audible alarms and error codes that appear on the display panel screen to alert you to an impending system change. Warnings do not affect operation.

With the exception of the error codes displayed on the screen, only the audible alarm can be enabled or disabled. Follow the steps in [“To adjust the alarm setting:” on page 3–6](#) to change the alarm settings.

The error codes are listed in [Table 5-1](#) below. The text in the **Error Code** column appears on the display screen of the display panel.

Table 5-1 Error Codes Displayed on the Display Panel Screen

Error Code	Condition	Mode	Action
<i>E01</i>	Low battery voltage shutdown < 10.5 Vdc (“ <i>SdL</i> ”) < 11.8 Vdc (“ <i>SdH</i> ”)	Inverting	<ul style="list-style-type: none"> • Check battery status and recharge if necessary. • Check for proper DC cable sizing. • Check for loose connections and tighten if necessary.
<i>E02</i>	High battery voltage shutdown (> 15.5 Vdc)	Inverting	<ul style="list-style-type: none"> • Check for external charging sources, such as an over voltage alternator, and disconnect if necessary.
<i>E03</i>	AC output overload shutdown	Inverting	<ul style="list-style-type: none"> • Reduce the loads connected to the AC outlet of the unit. • Check appliances that have high-surge ratings and disconnect if necessary.
<i>E04</i>	Over-temperature shutdown	Inverting	<ul style="list-style-type: none"> • Reduce the loads connected to the AC outlet of the unit. • Check that the ventilation grille is not blocked. • Check for ambient temperature and move the unit to a cooler location whenever possible.
<i>E05</i>	Low battery voltage detected < 11.0 Vdc (“ <i>SdL</i> ”) < 12.3 Vdc (“ <i>SdH</i> ”)	Inverting	<ul style="list-style-type: none"> • Check battery status and recharge if necessary. • Check for proper DC cable sizing. • Check for loose connections and tighten if necessary.
<i>E06</i>	AC output overload warning	Inverting	<ul style="list-style-type: none"> • Reduce the loads connected to the AC outlet of the unit.

Table 5-1 Error Codes Displayed on the Display Panel Screen

Error Code	Condition	Mode	Action
E07	Over-temperature warning	Inverting	<ul style="list-style-type: none"> • Reduce the loads connected to the AC outlet of the unit. • Check that the ventilation grille is not blocked. • Check for ambient temperature and move the unit to a cooler location whenever possible.
E08	not used		
E09	not used		
E 10	High battery voltage (> 15.5 V)	AC shore power	<ul style="list-style-type: none"> • Check for external charging sources, such as an over voltage alternator, and disconnect if necessary. • Confirm that the external charging source is not the cause. The error may be caused by the internal battery charger system. Call Xantrex for support.
E 11	Over-temperature detected on the AC transfer relay	AC shore power	<ul style="list-style-type: none"> • Reduce the loads connected to the AC outlet of the unit. • Check that the ventilation grille is not blocked. • Check for ambient temperature and move the unit to a cooler location whenever possible.
E 12	Battery is bad or external DC load is connected to the battery.	AC shore power	<ul style="list-style-type: none"> • Check the battery bank. NOTE: The battery voltage did not rise above 5 Vdc after 1 minute or 10 Vdc after 15 minutes. • Check that the external DC load current consumption is below the charging current setting. • Disconnect the DC load or increase the charger current setting.

For error codes *E01* to *E04*:

- the unit will stop inverting, and
- the display screen and the alarm will turn off after 30 seconds.

For error codes *E10* and *E11*:

- the unit will stop charging, but
- the error code will still show on the display screen and the alarm will remain on, and
- AC power will continue to pass through to the AC outlets.

For error code *E12*

- the unit will stop charging and shut down, and
- the error code will show on the display screen briefly, and
- AC power will not pass through to the AC outlets.

To reset error codes *E10* to *E12*:

1. Remove the AC input, and
2. Turn the unit OFF and then turn ON again using the Power button on the display panel.

Troubleshooting Reference



WARNING: Electrical shock and burn hazard

Do not disassemble the **Freedom HW**. It does not contain any user-serviceable parts. Repairing the unit yourself could result in an electrical shock or burn.

Table 5-2 Troubleshooting Reference

Problem	Possible Cause	Solution
Low output voltage (96 Vac–104 Vac) during Inverter mode.	You are using a voltmeter that cannot accurately read the RMS voltage of a modified sine wave.	Use a true RMS reading voltmeter such as the Fluke 87.
No output voltage. The status LED is red.	AC shore power is not available or out of operating range and the inverter has shut down with the display screen showing one of the following error codes:	
	<ul style="list-style-type: none"> Low input voltage (fault code $E01$) 	<ul style="list-style-type: none"> Check the DC connections and the cable. Recharge the battery.
	<ul style="list-style-type: none"> High input voltage (fault code $E02$) 	<ul style="list-style-type: none"> Verify the unit is connected to a 12V battery. Check the voltage regulation of the external charging system (if any).
	<ul style="list-style-type: none"> Unit overload or AC output short circuit (fault code $E03$) 	<ul style="list-style-type: none"> Reduce the load. Make sure the load does not exceed the output rating.
	<ul style="list-style-type: none"> Thermal shutdown (fault code $E04$) 	<ul style="list-style-type: none"> Allow the unit to cool off. Reduce the load if continuous operation is required. Improve ventilation. Make sure the inverter's ventilation openings are not blocked.
	<ul style="list-style-type: none"> AC transfer relay has overheated (during shore power mode). 	<ul style="list-style-type: none"> Improve ventilation. Make sure the inverter's ventilation grille is not blocked. Reduce the load.

Table 5-2 Troubleshooting Reference

Problem	Possible Cause	Solution
No output voltage. The Status LED is green or yellow.	<p>30 A supplementary breaker has tripped.</p> <p>Circuit breaker on the AC load panel or AC output disconnect has tripped.</p> <p>Battery voltage is too low to start inverting. Display screen may show DC voltage as $\square\square.\square$.</p>	<p>Check load and reset the supplementary breaker.</p> <p>Reset the circuit breaker or check the AC output disconnect circuits.</p> <p>Check DC connections and cable. Recharge battery.</p>
No output voltage. The status LED is not lighting up.	AC shore power is not available or out of operating range and the inverter is in OFF mode.	<ul style="list-style-type: none"> • Check AC shore power. • Turn the inverter ON or change the inverter setting to Standby mode.
	AC shore power is not available and the inverter is OFF due to a shutdown for more than 30 seconds.	<ul style="list-style-type: none"> • Check AC shore power and battery voltage. • Turn the inverter ON and look at the display panel for any error code. • See Table 5-1, “Error Codes Displayed on the Display Panel Screen” on page 5-5.
	The inverter’s DC input polarity is reversed.	<p>The inverter was probably damaged due to the reverse polarity. This type of damage is NOT covered by the warranty.</p> <ul style="list-style-type: none"> • Return the unit. • See Appendix WA, “Return Material Authorization Policy” page WA-3 for information on returning the unit.
The fan turns on and off during AC shore power mode.	<ul style="list-style-type: none"> • The battery is discharged and demands high current from the charger. • AC pass-through current is high. 	Do not be alarmed, the unit is performing normally.
The fan turns on and off during inverter mode.	The inverter is running continuously at high power.	Do not be alarmed, the unit is performing normally. The fan is activated automatically.

Table 5-2 Troubleshooting Reference

Problem	Possible Cause	Solution
Battery charging current is lower than the charging set point during bulk charge mode.	Ambient (environment) temperature is high.	Do not be alarmed, the unit is performing normally. The charging current automatically de-rates or shuts down at high ambient temperature. The charger resumes to normal when the unit's temperature cools down. Improve ventilation. Make sure the unit's ventilation openings are not blocked.
Alarm does not sound when an error is encountered.	Alarm is turned OFF.	Reactivate the alarm. See “To adjust the alarm setting:” on page 3–6.
The problem is not described in this table.	N/A	Visit www.xantrex.com/support.asp and check the FAQs (Frequently Asked Questions) for your product.

Inverter Applications

The **Freedom HW** performs differently depending on the AC loads connected to it. If you are having problems with any of your loads, read this section.

Resistive Loads

These are the loads that the inverter finds the simplest and most efficient to drive. Voltage and current are in phase (i.e. in step with one another). Resistive loads usually generate heat in order to accomplish their tasks. Toasters, coffee pots, and incandescent lights are typical resistive loads. It is usually impractical to run larger resistive loads—such as electric stoves and water heaters—from an inverter due to their high current requirements. Even though the inverter can most likely accommodate the load, the size of battery bank required would be impractical if the load is to be run for long periods.

Motor Loads

Induction motors (motors without brushes) require two to six times their running current on start up. The most demanding are those that start under load (e.g. compressors and pumps). Of the capacitor start motors (typical in drill presses, band saws, etc.), the largest you can expect to run is ½ to 1 hp (the transfer relays are rated at 2 hp.) Universal motors are generally easier to start. Since motor characteristics vary, only testing will determine whether a specific load can be started and how long it can be run.

If a motor fails to start within a few seconds or loses power after running for a time, it should be turned off. When the inverter attempts to start a load that is greater than it can handle, it will turn itself off after a few seconds.

Long Transfer Times

Xantrex has observed a specific situation where the **Freedom HW** may take a long time to transfer to inverter mode when shore power fails - maybe 0.1-0.2 seconds. This can occur when the **Freedom HW** is powering motor loads where the motor is able to “freewheel” when power is removed (e.g. a grinder). This long transfer may cause computers or other sensitive equipment to operate incorrectly. If power glitches must be minimized then Xantrex recommends that motor loads not be operated when sensitive equipment is being used.

High Surge When Powering Incandescent and CFL Bulbs

A single incandescent bulb requires five to ten times its power rating when lighting up from a cold start. If you have several bulbs lighting up all at the same time, then the surge is even greater.

A Compact Fluorescent Light or CFL also has a momentary surge that is more than ten times its power rating when lighting up from a cold start.

A

Specifications

[Appendix A](#) contains electrical performance information and product specifications.

Note: Specifications are subject to change without notice.

Electrical Specifications: Inverter Mode

DC Input	
Low operating voltage range “ SdL ” setting	10.5–15.5 V
High operating voltage range “ SdH ” setting	11.8–15.5 V
Under voltage alarm/shutdown Under voltage recovery “ SdL ” setting	10.5/11.0 V 12.0 V
Under voltage alarm/shutdown Under voltage recovery “ SdH ” setting	11.8/12.3 V 12.6 V
Safe non-operating voltage range	0–16 Vdc
Normal voltage	12.5V
Nominal current at full load	100A
AC Output	
Output voltage	120 Vac
Continuous power	1.0kW @ 25 °C
Surge power	17A (2kW for 200 ms)
Max short-circuit current	55A peak
Frequency	60 Hz
Wave shape	Modified Sinewave
Power derating above 40 °C ambient temp	See “Invert Power Derating vs. Ambient Temperature” on page A–6.
Peak efficiency	≥88%
Full load efficiency	≥85%
Other	
No load input power (producing output voltage)	≤10W
Off mode current draw	≤3mA

Electrical Specifications: Charge Mode

AC Input	
Operating voltage range	95–135 Vac
Nominal current	12Aac at 55A charge, 120 Vac in
Nominal frequency	60 Hz
DC Output	
Nominal voltage	12.0 Vdc
Min battery voltage for charging	0.0 Vdc
Max output voltage	14.4 Vdc
Nominal output current	User selectable: 5 A, 15 A, 35 A, 55 A
Charger current derating	Automatically reduce charger current as internal temperature exceeds 80 °C, and input Vac approaches low transfer.
Efficiency at nominal output	≥78%
Other	
Battery type settings	Flooded (default), Gel, AGM, or Fixed (13.5V)
Charge algorithms	Three stages (Bulk, Absorption, and Float)
Independent battery banks	1

Environmental Specifications

Operating Temperature Range	32–104 °F (0–40 °C), with output derated above 77 °F (25 °C)
Storage Temperature Range	-40–158 °F (-40–70 °C)
Humidity: Operation/Storage	5–95% RH, non-condensing

System Specifications

Pass-through	120 Vac, 60 Hz, 30 A, 3-hr Max, 24 A continuous
Transfer relay rating	30A, 2.0hp
Transfer time	<30ms (milliseconds)
Transfer on bad voltage	90–100V for low AC and 130–140 for high AC
Cooling	Fan, activated by any of the following: <ul style="list-style-type: none">• High internal temperature• High AC output power

Physical Specifications

Unit Dimensions and Weight	
Length	15.5" (39.3cm)
Width	9.5" (24.1cm)
Height	4.2" (10.6cm)
Weight	10.3 lbs (4.7 kg)

Regulatory Approvals

ETL approved to CSA 107.1, UL458

Inverter Overload Operation

This graph shows how long (measured in seconds) the **Freedom HW** will operate for a given output current (measured in Amps).

The graph illustrates inverter operation at 25 °C.

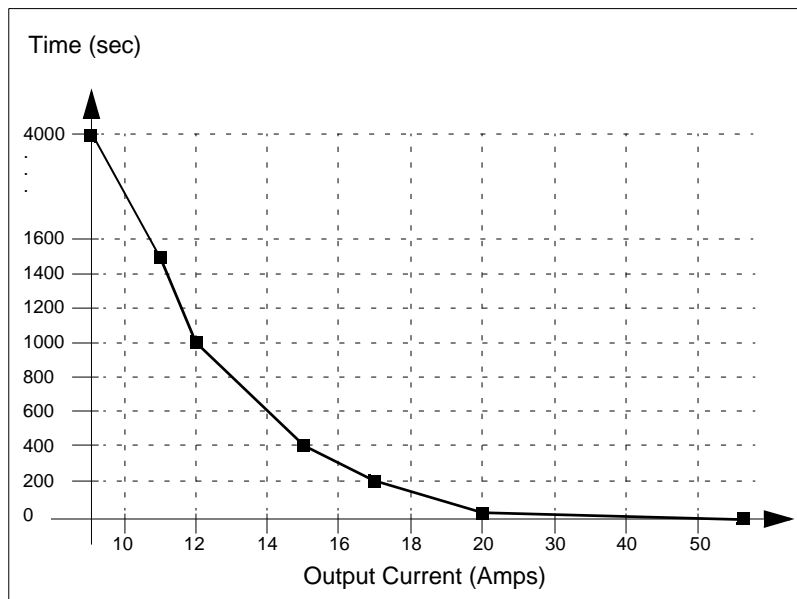

Invert Power Derating vs. Ambient Temperature

If the unit is in inverter mode and in elevated ambient temperature above 25 °C, you will have to reduce power draw according to the following chart to avoid over-temperature shutdown.

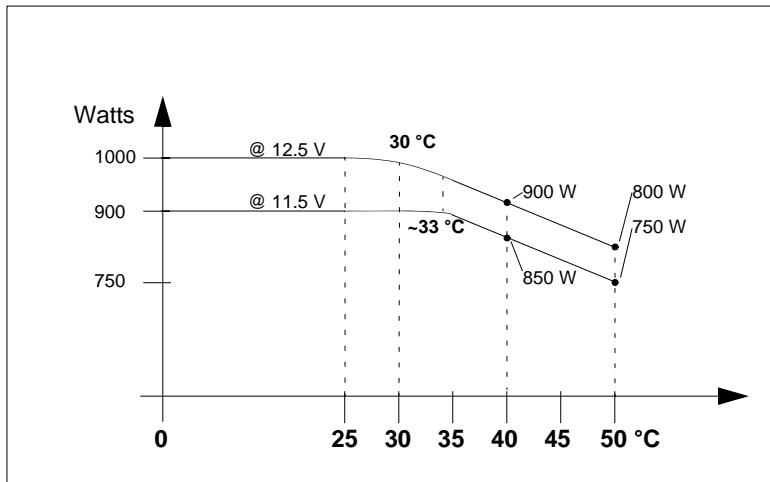

Charger Output Current vs. AC Input Voltage

When the **Freedom HW** is charging batteries from a weak shore power source the AC voltage may fall as the **Freedom HW** draws current. To reduce the chance of the shore power voltage collapsing below the configured transfer level the **Freedom HW** will reduce the charging current at low shore power voltage according to the following graph:

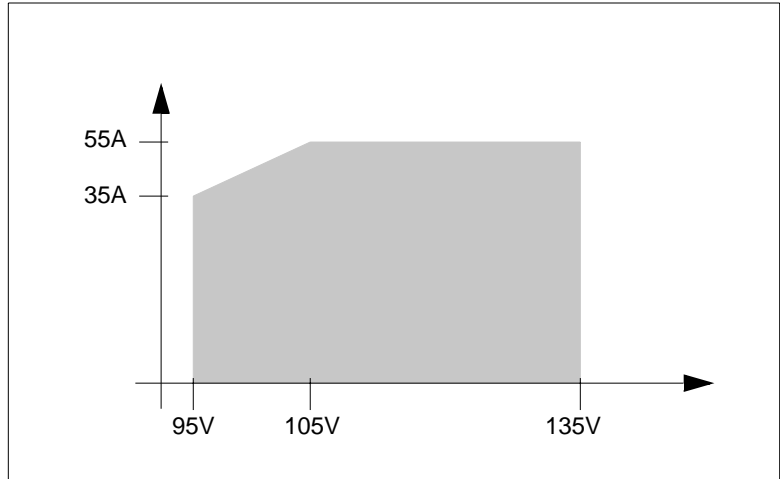

Table A-1 Charging Voltage

Battery Type	Bulk/Absorption (Volts)	Float (Volts)
Flooded	14.4	13.5
GEL	14.2	13.8
AGM	14.3	13.4
Fixed	13.5	13.5

Warranty and Return Information

Warranty

What does this warranty cover and how long does it last? This Limited Warranty is provided by Xantrex Technology Inc. ("Xantrex") and covers defects in workmanship and materials in your **Freedom HW Inverter/Charger**. This Warranty Period lasts for **12 Months** from the date of purchase at the point of sale to you, the original end user customer, unless otherwise agreed in writing. You will be required to demonstrate proof of purchase to make warranty claims.

This Limited Warranty is transferable to subsequent owners but only for the unexpired portion of the Warranty Period. Subsequent owners also require original proof of purchase as described in "What proof of purchase is required?"

What will Xantrex do? During the Warranty Period Xantrex will, at its option, repair the product (if economically feasible) or replace the defective product free of charge, provided that you notify Xantrex of the product defect within the Warranty Period, and provided that Xantrex through inspection establishes the existence of such a defect and that it is covered by this Limited Warranty.

Xantrex will, at its option, use new and/or reconditioned parts in performing warranty repair and building replacement products. Xantrex reserves the right to use parts or products of original or improved design in the repair or replacement. If Xantrex repairs or replaces a product, its warranty continues for the remaining portion of the original Warranty Period or 90 days from the date of the return shipment to the customer, whichever is greater. All replaced products and all parts removed from repaired products become the property of Xantrex.

Xantrex covers both parts and labor necessary to repair the product, and return shipment to the customer via a Xantrex-selected non-expedited surface freight within the contiguous United States and Canada. Alaska, Hawaii and outside of the United States and Canada are excluded. Contact Xantrex Customer Service for details on freight policy for return shipments from excluded areas.

How do you get service? If your product requires troubleshooting or warranty service, contact your merchant. If you are unable to contact your merchant, or the merchant is unable to provide service, contact Xantrex directly at:

Telephone: 1 800 670 0707 (toll free North America)
1 408 987 6030 (direct)

Fax: 1 800 994 7828 (toll free North America)
1 604 422 2756 (direct)

Email: customerservice@xantrex.com

Website: www.xantrex.com

Direct returns may be performed according to the Xantrex Return Material Authorization Policy described in your product manual. For some products, Xantrex maintains a network of regional Authorized Service Centers. Call Xantrex or check our website to see if your product can be repaired at one of these facilities.

What proof of purchase is required? In any warranty claim, dated proof of purchase must accompany the product and the product must not have been disassembled or modified without prior written authorization by Xantrex.

Warranty and Return

Proof of purchase may be in any one of the following forms:

- The dated purchase receipt from the original purchase of the product at point of sale to the end user; or
- The dated dealer invoice or purchase receipt showing original equipment manufacturer (OEM) status; or
- The dated invoice or purchase receipt showing the product exchanged under warranty.

What does this warranty not cover? Claims are limited to repair and replacement, or if in Xantrex's discretion that is not possible, reimbursement up to the purchase price paid for the product. Xantrex will be liable to you only for direct damages suffered by you and only up to a maximum amount equal to the purchase price of the product.

This Limited Warranty does not warrant uninterrupted or error-free operation of the product or cover normal wear and tear of the product or costs related to the removal, installation, or troubleshooting of the customer's electrical systems. This warranty does not apply to and Xantrex will not be responsible for any defect in or damage to:

- a) the product if it has been misused, neglected, improperly installed, physically damaged or altered, either internally or externally, or damaged from improper use or use in an unsuitable environment;
- b) the product if it has been subjected to fire, water, generalized corrosion, biological infestations, or input voltage that creates operating conditions beyond the maximum or minimum limits listed in the Xantrex product specifications including, but not limited to, high input voltage from generators and lightning strikes;
- c) the product if repairs have been done to it other than by Xantrex or its authorized service centers (hereafter "ASCs");
- d) the product if it is used as a component part of a product expressly warranted by another manufacturer;
- e) component parts or monitoring systems supplied by you or purchased by Xantrex at your direction for incorporation into the product;
- f) the product if its original identification (trade-mark, serial number) markings have been defaced, altered, or removed;
- g) the product if it is located outside of the country where it was purchased; and
- h) any consequential losses that are attributable to the product losing power whether by product malfunction, installation error or misuse.

Disclaimer

Product

THIS LIMITED WARRANTY IS THE SOLE AND EXCLUSIVE WARRANTY PROVIDED BY XANTREX IN CONNECTION WITH YOUR XANTREX PRODUCT AND IS, WHERE PERMITTED BY LAW, IN LIEU OF ALL OTHER WARRANTIES, CONDITIONS, GUARANTEES, REPRESENTATIONS, OBLIGATIONS AND LIABILITIES, EXPRESS OR IMPLIED, STATUTORY OR OTHERWISE IN CONNECTION WITH THE PRODUCT, HOWEVER ARISING (WHETHER BY CONTRACT, TORT, NEGLIGENCE, PRINCIPLES OF MANUFACTURER'S LIABILITY, OPERATION OF LAW, CONDUCT, STATEMENT OR OTHERWISE), INCLUDING WITHOUT RESTRICTION ANY IMPLIED WARRANTY OR CONDITION OF QUALITY, MERCHANTABILITY OR FITNESS FOR A PARTICULAR PURPOSE. ANY IMPLIED WARRANTY OF MERCHANTABILITY OR FITNESS FOR A PARTICULAR PURPOSE TO THE EXTENT REQUIRED UNDER APPLICABLE LAW TO APPLY TO THE PRODUCT SHALL BE LIMITED IN DURATION TO THE PERIOD STIPULATED UNDER THIS LIMITED WARRANTY.

IN NO EVENT WILL XANTREX BE LIABLE FOR: (A) ANY SPECIAL, INDIRECT, INCIDENTAL OR CONSEQUENTIAL DAMAGES, INCLUDING LOST PROFITS, LOST REVENUES, FAILURE TO REALIZE EXPECTED SAVINGS, OR OTHER COMMERCIAL OR ECONOMIC LOSSES OF ANY KIND, EVEN IF XANTREX HAS BEEN ADVISED, OR HAD REASON TO KNOW, OF THE POSSIBILITY OF SUCH DAMAGE, (B) ANY LIABILITY ARISING

IN TORT, WHETHER OR NOT ARISING OUT OF XANTREX'S NEGLIGENCE, AND ALL LOSSES OR DAMAGES TO ANY PROPERTY OR FOR ANY PERSONAL INJURY OR ECONOMIC LOSS OR DAMAGE CAUSED BY THE CONNECTION OF A PRODUCT TO ANY OTHER DEVICE OR SYSTEM, AND (C) ANY DAMAGE OR INJURY ARISING FROM OR AS A RESULT OF MISUSE OR ABUSE, OR THE INCORRECT INSTALLATION, INTEGRATION OR OPERATION OF THE PRODUCT.

IF YOU ARE A CONSUMER (RATHER THAN A PURCHASER OF THE PRODUCT IN THE COURSE OF A BUSINESS) AND PURCHASED THE PRODUCT IN A MEMBER STATE OF THE EUROPEAN UNION, THIS LIMITED WARRANTY SHALL BE SUBJECT TO YOUR STATUTORY RIGHTS AS A CONSUMER UNDER THE EUROPEAN UNION PRODUCT WARRANTY DIRECTIVE 1999/44/EC AND AS SUCH DIRECTIVE HAS BEEN IMPLEMENTED IN THE EUROPEAN UNION MEMBER STATE WHERE YOU PURCHASED THE PRODUCT. FURTHER, WHILE THIS LIMITED WARRANTY GIVES YOU SPECIFIC LEGAL RIGHTS, YOU MAY HAVE OTHER RIGHTS WHICH MAY VARY FROM EU MEMBER STATE TO EU MEMBER STATE OR, IF YOU DID NOT PURCHASE THE PRODUCT IN AN EU MEMBER STATE, IN THE COUNTRY YOU PURCHASED THE PRODUCT WHICH MAY VARY FROM COUNTRY TO COUNTRY AND JURISDICTION TO JURISDICTION.

Return Material Authorization Policy

For those products that are not being repaired in the field and are being returned to Xantrex, before returning a product directly to Xantrex you must obtain a Return Material Authorization (RMA) number and the correct factory "Ship To" address. Products must also be shipped prepaid. Product shipments will be refused and returned at your expense if they are unauthorized, returned without an RMA number clearly marked on the outside of the shipping box, if they are shipped collect, or if they are shipped to the wrong location.

When you contact Xantrex to obtain service, please have your instruction manual ready for reference and be prepared to supply:

- The serial number of your product
- Information about the installation and use of the unit
- Information about the failure and/or reason for the return
- A copy of your dated proof of purchase

Record these details on page WA-5.

Return Procedure

Package the unit safely, preferably using the original box and packing materials. Please ensure that your product is shipped fully insured in the original packaging or equivalent. This warranty will not apply where the product is damaged due to improper packaging.

Include the following:

- The RMA number supplied by Xantrex Technology Inc. clearly marked on the outside of the box.
- A return address where the unit can be shipped. Post office boxes are not acceptable.
- A contact telephone number where you can be reached during work hours.
- A brief description of the problem.

Ship the unit prepaid to the address provided by your Xantrex customer service representative.

If you are returning a product from outside of the USA or Canada In addition to the above, you **MUST** include return freight funds and are fully responsible for all documents, duties, tariffs, and deposits.

If you are returning a product to a Xantrex Authorized Service Center (ASC) A Xantrex return material authorization (RMA) number is not required. However, you must contact the ASC prior to returning the product or presenting the unit to verify any return procedures that may apply to that particular facility and that the ASC repairs this particular Xantrex product.

Out of Warranty Service

If the warranty period for your product has expired, if the unit was damaged by misuse or incorrect installation, if other conditions of the warranty have not been met, or if no dated proof of purchase is available, your unit may be serviced or replaced for a flat fee.

To return your product for out of warranty service, contact Xantrex Customer Service for a Return Material Authorization (RMA) number and follow the other steps outlined in "Return Procedure" on page WA-4.

Payment options such as credit card or money order will be explained by the Customer Service Representative. In cases where the minimum flat fee does not apply, as with incomplete units or units with excessive damage, an additional fee will be charged. If applicable, you will be contacted by Customer Service once your unit has been received.

Information About Your System

As soon as you open your **Freedom HW Inverter/Charger** package, record the following information and be sure to keep your proof of purchase.

- Serial Number _____
- Product Number **806-1055**
- Purchased From _____
- Purchase Date _____

If you need to contact Customer Service, please record the following details before calling. This information will help our representatives give you better service.

- Type of installation _____
(e.g. RV, truck)
- Length of time inverter has been installed _____
- Battery/battery bank size _____
- Battery type (e.g. flooded, sealed gel cell, AGM) _____
- DC wiring size and length _____
- Alarm sounding? _____
- Description of indicators on front panel _____
- Appliances operating when problem occurred _____
- Description of problem _____

Xantrex Technology Inc.

1 800 670 0707 Tel toll free NA

1 408 987 6030 Tel direct

1 800 994 7828 Fax toll free NA

customerservice@xantrex.com

www.xantrex.com

975-0467-01-01

Printed in China

Free Manuals Download Website

<http://myh66.com>

<http://usermanuals.us>

<http://www.somanuals.com>

<http://www.4manuals.cc>

<http://www.manual-lib.com>

<http://www.404manual.com>

<http://www.luxmanual.com>

<http://aubethermostatmanual.com>

Golf course search by state

<http://golfingnear.com>

Email search by domain

<http://emailbydomain.com>

Auto manuals search

<http://auto.somanuals.com>

TV manuals search

<http://tv.somanuals.com>