

Smart choice for power

xantrex

**GPIB-M-XPD
GPIB-M-XT
GPIB-M-HPD
GPIB-M-XHR
GPIB-M-XFR
GPIB-M-XFR3**

Operating Manual

**Internal GPIB-M Interface:
Multichannel Functionality
for Programmable DC
Power Supplies**

www.xantrex.com



Operating Manual for

Internal GPIB-M Interface: Multichannel Functionality for Programmable DC Power Supplies

Limited Warranty

What does this warranty cover and how long does it last?

This Limited Warranty is provided by Xantrex Technology, Inc. (“Xantrex”) and covers defects in workmanship and materials in your **GPIB-M Interface Card**. This warranty lasts for a Warranty Period of **5 years** from the date of purchase at point of sale to you, the original end user customer.

What will Xantrex do?

Xantrex will, at its option, repair or replace the defective product free of charge, provided that you notify Xantrex of the product defect within the Warranty Period, and provided that Xantrex through inspection establishes the existence of such a defect and that it is covered by this Limited Warranty.

Xantrex will, at its option, use new and/or reconditioned parts in performing warranty repair and building replacement products. Xantrex reserves the right to use parts or products of original or improved design in the repair or replacement. If Xantrex repairs or replaces a product, its warranty continues for the remaining portion of the original Warranty Period or 90 days from the date of the return shipment to the customer, whichever is greater. All replaced products and all parts removed from repaired products become the property of Xantrex.

Xantrex covers both parts and labor necessary to repair the product, and return shipment to the customer via a Xantrex-selected non-expedited surface freight within the contiguous United States and Canada. Alaska and Hawaii are excluded. Contact Xantrex Customer Service for details on freight policy for return shipments outside of the contiguous United States and Canada.

How do you get service?

If your product requires troubleshooting or warranty service, contact your merchant. If you are unable to contact your merchant, or the merchant is unable to provide service, contact Xantrex directly at:

Phone:	604 422 8595
Toll Free North America:	1 800 667 8422
Fax:	604 421 3056
Email:	info@xantrex.com

Direct returns may be performed according to the Xantrex Return Material Authorization Policy described in your product manual. For some products, Xantrex maintains a network of regional Authorized Service Centers. Call Xantrex or check our website to see if your product can be repaired at one of these facilities.

In any warranty claim, dated proof of purchase must accompany the product and the product must not have been disassembled or modified without prior written authorization by Xantrex.

Proof of purchase may be in any one of the following forms:

- The dated purchase receipt from the original purchase of the product at point of sale to the end user, or
- The dated dealer invoice or purchase receipt showing original equipment manufacturer (OEM) status, or
- The dated invoice or purchase receipt showing the product exchanged under warranty

What does this warranty not cover?

This Limited Warranty does not cover normal wear and tear of the product or costs related to the removal, installation, or troubleshooting of the customer's electrical systems. This warranty does not apply to and Xantrex will not be responsible for any defect in or damage to:

- a. the product if it has been misused, neglected, improperly installed, physically damaged or altered, either internally or externally, or damaged from improper use or use in an unsuitable environment;
- b. the product if it has been subjected to fire, water, generalized corrosion, biological infestations, and high input voltage from lightning strikes;
- c. the product if repairs have been done to it other than by Xantrex or its authorized service centers (hereafter "ASCs");
- d. the product if it is used as a component part of a product expressly warranted by another manufacturer;
- e. the product if its original identification (trade-mark, serial number) markings have been defaced, altered, or removed.

Disclaimer Product

THIS LIMITED WARRANTY IS THE SOLE AND EXCLUSIVE WARRANTY PROVIDED BY XANTREX IN CONNECTION WITH YOUR XANTREX PRODUCT AND IS, WHERE PERMITTED BY LAW, IN LIEU OF ALL OTHER WARRANTIES, CONDITIONS, GUARANTEES, REPRESENTATIONS, OBLIGATIONS AND LIABILITIES, EXPRESS OR IMPLIED, STATUTORY OR OTHERWISE IN CONNECTION WITH THE PRODUCT, HOWEVER ARISING (WHETHER BY CONTRACT, TORT, NEGLIGENCE, PRINCIPLES OF MANUFACTURER'S LIABILITY, OPERATION OF LAW, CONDUCT, STATEMENT OR OTHERWISE), INCLUDING WITHOUT RESTRICTION ANY IMPLIED WARRANTY OR CONDITION OF QUALITY, MERCHANTABILITY OR FITNESS FOR A PARTICULAR PURPOSE. ANY IMPLIED WARRANTY OF MERCHANTABILITY OR FITNESS FOR A PARTICULAR PURPOSE TO THE EXTENT REQUIRED UNDER APPLICABLE LAW TO APPLY TO THE PRODUCT SHALL BE LIMITED IN DURATION TO THE PERIOD STIPULATED UNDER THIS LIMITED WARRANTY.

IN NO EVENT WILL XANTREX BE LIABLE FOR ANY SPECIAL, DIRECT, INDIRECT, INCIDENTAL OR CONSEQUENTIAL DAMAGES, LOSSES, COSTS OR EXPENSES HOWEVER ARISING WHETHER IN CONTRACT OR TORT INCLUDING WITHOUT RESTRICTION ANY ECONOMIC LOSSES OF ANY KIND, ANY LOSS OR DAMAGE TO PROPERTY, ANY PERSONAL INJURY, ANY DAMAGE OR INJURY ARISING FROM OR AS A RESULT OF MISUSE OR ABUSE, OR THE INCORRECT INSTALLATION, INTEGRATION OR OPERATION OF THE PRODUCT.

Exclusions If this product is a consumer product, federal law does not allow an exclusion of implied warranties. To the extent you are entitled to implied warranties under federal law, to the extent permitted by applicable law they are limited to the duration of this Limited Warranty. Some states and provinces do not allow limitations or exclusions on implied warranties or on the duration of an implied warranty or on the limitation or exclusion of incidental or consequential damages, so the above limitation(s) or exclusion(s) may not apply to you. This Limited Warranty gives you specific legal rights. You may have other rights which may vary from state to state or province to province.

Information WITHOUT LIMITING THE GENERALITY OF THE FOREGOING, UNLESS SPECIFICALLY AGREED TO BY IT IN WRITING, XANTREX

- a. MAKES NO WARRANTY AS TO THE ACCURACY, SUFFICIENCY OR SUITABILITY OF ANY TECHNICAL OR OTHER INFORMATION PROVIDED IN MANUALS OR OTHER DOCUMENTATION PROVIDED BY IT IN CONNECTION WITH THE PRODUCT; AND
- b. ASSUMES NO RESPONSIBILITY OR LIABILITY FOR LOSSES, DAMAGES, COSTS OR EXPENSES, WHETHER SPECIAL, DIRECT, INDIRECT, CONSEQUENTIAL OR INCIDENTAL, WHICH MIGHT ARISE OUT OF THE USE OF SUCH INFORMATION.

THE USE OF ANY SUCH INFORMATION WILL BE ENTIRELY AT THE USER'S RISK.

WARNING: Please refer to your product user manual for limitations on uses of the product.
Limitations on Use Specifically, please note that this power supply is not intended for use in connection with life support systems and Xantrex makes no warranty or representation in connection with any use of the product for such purposes.

Xantrex Technology, Inc.
8999 Nelson Way
Burnaby, British Columbia
Canada V5A 4B5

Information About Your Power Supply Please record the following information when you first open your Power Supply package:

Model Number	_____
Serial Number	_____
Purchased From	_____
Purchase Date	_____

Release Release 2.1 (2003-04)

Copyright © 2002 Xantrex Technology Inc. All rights reserved.
Printed in Canada

Power Supply Safety



WARNING—High Energy and High Voltage

Exercise caution when using and calibrating a power supply. High energy levels can be stored at the output voltage terminals on a power supply in normal operation. In addition, potentially lethal voltages exist in the power circuit and on the output and sense connectors of a power supply with a rated output greater than 40 V. Filter capacitors store potentially dangerous energy for some time after power is removed.



CAUTION

Operate the power supply in an environment free of flammable gases or fumes. To ensure that the power supply's safety features are not compromised, use the power supply as specified in this manual and do not substitute parts or make any unauthorized modifications. Contact the service technician for service and repair help. Repairs must be made by experienced service technicians only.

Warnings, Cautions, and Notes

Warnings, cautions, and notes are defined and formatted in this manual as shown below.



WARNING

Describes a potential hazard which could result in injury or death, or, a procedure which, if not performed correctly, could result in injury or death.



CAUTION

Describes a procedure which, if not performed correctly, could result in damage to data, equipment, or systems.

Note

Describes additional operating information which may affect the performance of the equipment.

About This Manual

This operating manual is for the internal Multichannel Interface (GPIB-M), a microprocessor-controlled option card for your DC output power supply. This manual provides you with descriptions and specifications, user options, and configuration instructions, in addition to a command set which enables you to manage the power supply from an external source. Error messages and calibration procedures are also included.

This manual is designed for the user who is familiar with basic electrical theory especially as it applies to the operation of power supplies. This implies a recognition of Constant Voltage and Constant Current operation modes and the control of input and output power, as well as the observance of safe techniques while effecting supply or pin connections and any changes in switch settings. The user should also have experience with a computer-based communications software package.

Refer to your power supply manual for installation, configuration, and operating procedures for your power supply.

Main Sections

Section 1 Features and Specifications Describes the power supply and lists its features and specifications.

Section 2 Installation and Configuration Gives basic setup procedures. Describes inspection, cleaning, shipping, and storage procedures. Includes additional options for configuring the GPIB-M interface for operation.

Section 3 Operation Describes operation of each feature.

Section 4 Status Registers Details status registers and how to use them to monitor the power supply status.

Section 5 Current Sharing Explains how to configure the power supply for current sharing among units connected in parallel.

Appendix A GPIB Describes the General Purpose Interface Bus (GPIB) commands and lines supported by specific products with the Multichannel Interface installed.

About This Manual

Appendix B SCPI Command Reference Describes the Standard Commands for Programmable Instruments (SCPI) commands supported by various products with the Multichannel Interface installed.

Appendix C Error Messages Describes the error messages that could appear during operation.

Appendix D Calibration Provides the calibration procedures and parameters.

Manual Revisions

The current release of this manual is listed below. Updates may be issued as an addendum.

Release 2.1 (2003-04)

Power Supply Safety Markings



Alternating Current



Earth (Ground) Terminal



Protective Conductor Terminal



Off (Supply)



On (Supply)



Caution (Check manual for additional information.)

Table of Contents

About This Manual	vii
List of Tables	xiii
List of Figures	xv

Section 1. Features and Specifications

Description	17
Features and Functions	17
Features	17
Programmable Functions	18
Readback Functions	18
Specifications	19

Section 2. Installation and Configuration

Introduction	25
Initial Inspection	25
Basic Setup Procedure	31
Setup Procedure	32
Power On Service Request	33
Configure for GPIB Operation	34
Change Remote Control Source	34
Set GPIB Address	34
Configure for Multichannel Operation	35
Multichannel Connections	35
Multichannel Configuration	35
CANbus	36
CANbus Cables	36
Configuration of CAN-only Interface Cards	36
Setup	37
Using Multichannel Operation	37
Multichannel Commands	38
Broadcasting Commands	39
Specifications	39
User Lines	40
User Lines Connection (XT, HPD, XPD)	41

Section 3. Operation

Overview	43
Powering ON the Power Supply	43
Power Supply Operating States	44
Power-On	44
Output Shutdown	44
Soft Start	44
Normal Operation	44
Calibration	44

Power Supply Regulation Modes	45
Constant Voltage (CV)	45
Constant Current (CC)	45
Automatic Mode Crossover	45
Remote Control Modes	46
Front Panel LEDs	47
Power Supply Operation	48
Change Remote/Local Mode	48
Power On Remote State	49
Enable Output	49
Set Voltage and Current	49
Readback	50
Configure Output Protection	51
OVP	52
Fold Protection	52
Additional Protections	53
Set Shutdown Recovery for AC Off	53
AC Off Protection	53
Over Temperature Protection	53
Clear Protection Event	54
Shutdown vs Protection Alarm	54
User Settings (Save and Recall)	55
Set Up Power ON Defaults	56
Power On Output State	57
Reset	57
Read Error Messages	58
Clear Status	58
Configure Auxiliary Status Lines	58
Auto Sequencing	60
Programming a Sequence	60
Deleting a Sequence	63
Using Auto Sequencing	63
Set V, I, and P Limits	65
Triggered Setpoints	65
Triggering Commands	66
Slew Rate	67
Identification Query	68
Option Identification Query	68
SCPI Version Query	68

Section 4. Status Registers

Overview	69
Condition Register	69
Event Register	69
Enable Register	69
Transition Filters	69
OPERation Status Register	69
REGulating Sub-Register	72

SHUTdown Sub-Register	73
Protection SHUTdown Sub-Register	73
Remote CONtrol Sub-Register	73
Current SHare Sub-Register	74
QUESTionable Status Register	74
VOLTage Sub-Register	76
CURRent Sub-Register	77
Standard Event Status Register	77
Status Byte	79
Master Summary Status (MSS)	80
Request Service (RQS)	80
Status Register Commands	81
SCPI Status Commands	81
IEEE 488.2 Status and Event Commands	82
Operation Status Register Commands	85
Regulating Sub-Register Commands	85
Shutdown Sub-Register Commands	85
Protection Shutdown Sub-Register Commands	86
Remote Control Sub-Register Commands	86
Current Share Sub-Register Commands	87
Questionable Status Register Commands	87
Voltage Sub-Register Commands	88
Current Sub-Register Commands	88

Section 5. Current Sharing

Overview	89
Theory of Operation	90
Configure Current Share	90
Setup Current Sharing Network	90
Operation	91
Errors	91

Appendix A. GPIB

Overview	93
Codes and Standards	93
Message Terminators	93
Address Range	93
Primary	93
Secondary	93
Service Request and Polling	93
Protocol Specifications	94
Multiline Control Functions	94
Interface Functions	94
Electrical Specifications	95
Driver Requirements	95
Mechanical Specifications	95
Performance Specifications	95

Appendix B. SCPI Command Reference

Overview	97
Codes and Standards	97
IEEE 488.2 Requirements	97
SCPI Requirements	97
IEEE-488.2/SCPI Syntax and Style	98
Parameters	98
Understanding SCPI Commands	99
SCPI Command Hierarchy	99
Using SCPI Commands	99
Parameter Types	102
SCPI Command Summary	103
Notations Used in the Tables	103
Expressions	115

Appendix C. Error Messages

Overview	117
Command Error List	118
Execution Error List	118
Device-Specific Error List	120
Query Error List	121
User Request Event	121
Operation Complete Event	121
Front Panel Error Codes	122
CPU Error Codes	122
Analog Programming Interface Error codes	122
Auto Sequencing Error Codes	122
CANbus Error Codes	123
Multichannel Error Codes	123
Current Share Error Codes	124

Appendix D. Calibration

Overview	125
Entering Calibration Mode	125
Security code	126
Setup and Equipment	126
Calibration Procedure	127
Output Voltage	127
Output Current	128
Exit calibration mode	129
Restore Factory Calibration	129

List of Tables

Table 1.1	Specifications for HPD 300 W with GPIB-M or CANbus	19
Table 1.2	Specifications for XFR 1200 W with GPIB-M or CANbus	20
Table 1.3	Specifications for XFR 2800 W with GPIB-M or CANbus	21
Table 1.4	Specifications for XHR 1000 W with GPIB-M or CANbus	22
Table 1.5	Specifications for XPD 500 W with GPIB-M or CANbus	23
Table 1.6	Specifications for XT 60 W with GPIB-M or CANbus	23
Table 2.1	Remote Mode Power On Conditions	33
Table 2.2	CANbus Pins	36
Table 2.3	User Line Pins	40
Table 3.1	Power Supply Factory Defaults	46
Table 3.2	Features Affected by Reset (*RST) Command	57
Table 4.1	OPERation Status Register	72
Table 4.2	REGulating Sub-Register	72
Table 4.3	SHUTdown Sub-Register	73
Table 4.4	Protection SHUTdown Sub-Register	73
Table 4.5	Remote CONTROL Sub-Register	74
Table 4.6	Current SHare Sub-Register	74
Table 4.7	QUESTionable Status Register	76
Table 4.8	VOLTage Sub-Register	76
Table 4.9	CURRent Sub-Register	77
Table 4.10	Standard Event Status Register	78
Table 4.11	Status Byte Summary Register	79
Table 4.12	Preset Values of User Configurable Registers	81
Table A.1	Multiline Control Functions	94
Table A.2	Interface Functions	94
Table A.3	Driver Types for Interface Lines.	95
Table B.1	IEEE 488.2 Commands	104
Table B.2	Readback Commands	105
Table B.3	Commands for Output Control.	106
Table B.4	Commands for Current Share	107
Table B.5	Commands for Calibration.	107
Table B.6	Command to Clear all Protection Mechanisms	107
Table B.7	Commands for Fold Protection	108
Table B.8	Commands for Triggering	108
Table B.9	System Commands	108
Table B.10	Status Commands	109

List of Tables

Table B.11	Protection Commands	112
Table B.12	User Lines	112
Table B.13	Output State	112
Table B.14	Auto Sequence Commands	113
Table B.15	Expressions	115
Table C.1	Command Error List	118
Table C.2	Execution Error List	118
Table C.3	Device-Specific Error List	120
Table C.4	Query Error List	121
Table C.5	User Request Event	121
Table C.6	Operation Complete Event	121
Table C.7	Front Panel Error Codes	122
Table C.8	CPU Error Codes	122
Table C.9	Analog Programming Interface Error code	122
Table C.10	Auto Sequencing Error Codes	122
Table C.11	CANbus Error Codes	123
Table C.12	Multichannel Error Codes	123
Table C.13	Current Share Error Codes	124

List of Figures

Figure 2.1	XFR and XHR Power Supply Front Panel with GPIB-M Interface	26
Figure 2.2	XPD Power Supply Front Panel with GPIB Interface	27
Figure 2.3	XT and HPD Power Supply Front Panel with GPIB Interface	27
Figure 2.4	XFR 2800 Watt Power Supply Rear Panel with GPIB-M Interface	28
Figure 2.5	XFR 1200 Watt Power Supply Rear Panel with GPIB-M Interface	28
Figure 2.6	XHR Power Supply Rear Panel with GPIB-M Interface	29
Figure 2.7	XPD Power Supply Rear Panel with GPIB-M Interface	29
Figure 2.8	XT/HPD Power Supply Rear Panel with GPIB-M Interface	30
Figure 2.9	XFR GPIB Cable with Ferrite Block	31
Figure 2.10	Connections for Multichannel Operation	37
Figure 2.11	User Signals Connector (XT, HPD and XPD)	41
Figure 2.12	XT, HPD, XPD User Cable with Ferrite Block	41
Figure 2.13	Schematic For User Line Interface	42
Figure 4.1	Operation Status Registers	71
Figure 4.2	Questionable Status Registers	75
Figure 4.3	IEEE 488.2 Status Register and Status Byte	77
Figure 5.1	Example of Current Share Operation	89

List of Figures

Section 1. Features and Specifications

Description

The internal GPIB-M interface card allows you to operate your power supply from a computer controller via the IEEE-488 communications bus.

The GPIB-M interface allows complete remote programming of your power supply, including status reporting, settings query, and service request generation with user-designated conditions. Both the voltage and current output are precisely programmed directly in volts and amps with 16-bit resolution. Additionally, the 16-bit readbacks measure the actual power supply output. The programming command set is easy to use and includes software calibration commands. The interface card comes with several protection features such as programmable over and under voltage protection, and soft limits.

Multichannel addressing via CANbus allows up to 50 power supplies to be controlled from one GPIB address. This manual covers operation of both the GPIB-M and CAN-only interface cards.

Features and Functions

- Features**
- 16-bit programming and readback of voltage and current
 - Programmable soft limits for voltage and current
 - LED status signals: remote operation, service request and shutdown; (XFR and XHR only) error, addressed, over voltage protection, auxiliary status bits
 - Software calibration
 - Automatic voltage/current mode crossover
 - Shutdown or warning for over- and under-programmed trip points
 - Programmable auxiliary status lines for monitoring power supply conditions
 - Remote interlock and trigger lines
 - Selectable standby, programmed sequence and other power-on defaults
 - Active current sharing with parallel connected units for higher power requirements
 - CANbus communications link for multichannel addressing, and master/slave current sharing
 - Extensive SCPI command set for control and status monitoring

Features and Specifications

Features and Functions

- Programmable Functions**
 - Output voltage and current
 - Soft limits for voltage and current
 - Overvoltage protection
 - Output enable/disable
 - Ten, 99-step auto sequences for easy programming of complex test routines
 - Ten stored settings
 - Five load protection mechanisms including fold protection in CV or CC mode

- Readback Functions**
 - Actual measured voltage and current
 - Voltage and current settings
 - Soft voltage and current limits
 - Overvoltage protection setting
 - Programming error codes
 - Power supply model and version identification
 - Firmware revision levels

Specifications

The specifications in this section are warranted at 25°C ±5°C unless otherwise specified. All specifications are subject to change without notice.

Table 1.1 Specifications for HPD 300 W with GPIB-M or CANbus

Models	15-20	30-10	60-5
Program Resolution			
Voltage	2.4mV	4.7mV	9.3mV
Current	2.8mA	1.4mA	0.7mA
Program Accuracy¹			
Voltage	60mV ±0.1%	70mV ±0.1%	90mV ±0.12%
Current	75mA ±0.12%	50mA ±0.12%	25mA ±0.1%
Readback Resolution			
Voltage	2.4mV	4.7mV	9.3mV
Current	2.8mA	1.4mA	0.7mA
Readback Accuracy¹			
Voltage	45mV ±0.3%	90mV ±0.3%	175mV ±0.3%
Current	75mA ±0.12%	40mA ±0.12%	25mA ±0.1%

1. Apply accuracy specifications according to the following voltage program accuracy example:
Set a model HPD 15-20 power supply to 10 volts.
The expected result will be within the range of 10 volts ± 60mV ± 0.1% of the set voltage of 10 volts.

Features and Specifications

Specifications

Table 1.2 Specifications for XFR 1200 W with GPIB-M or CANbus

Models	7.5-140	12-100	20-60	35-35	40-30
Program Resolution					
Voltage	1.16mV	1.8mV	3.08mV	5.4mV	6.2mV
Current	19.6mA	14mA	8.4mA	5.4mA	4.2mA
Program Accuracy ¹					
Voltage	10mV ±0.12%	50mV ±0.12%	75mV ±0.12%	75mV ±0.3%	75mV ±0.3%
Current	500mA ±0.1%	460mA ±0.1%	250mA ±0.1%	200mA ±0.1%	150mA ±0.15%
Readback Resolution					
Voltage	1.16mV	1.8mV	3.08mV	5.4mV	6.2mV
Current	19.6mA	14mA	8.4mA	5.4mA	4.2mA
Readback Accuracy ¹					
Voltage	30mV ±0.12%	60mV ±0.12%	75mV ±0.12%	75mV ±0.3%	75mV ±0.3%
Current	500mA ±0.1%	460mA ±0.1%	250mA ±0.1%	200mA ±0.1%	150mA ±0.15%

Models	60-20	100-12	150-8	300-4	600-2
Program Resolution					
Voltage	9.2mV	15.4mV	23.1mV	46.2mV	92.4mV
Current	2.8mA	1.68mA	1.12mA	0.56mA	0.28mA
Program Accuracy ¹					
Voltage	150mV ±0.25%	150mV ±0.35%	225mV ±0.35%	225mV ±0.35%	250mV ±0.35%
Current	120mA ±0.1%	80mA ±0.1%	80mA ±0.1%	80mA ±0.1%	50mA ±0.1%
Readback Resolution					
Voltage	9.2mV	15.4mV	23.1mV	46.2mV	92.4mV
Current	2.8mA	1.68mA	1.12mA	0.56mA	0.28mA
Readback Accuracy ¹					
Voltage	150mV ±0.25%	150mV ±0.35%	225mV ±0.35%	225mV ±0.35%	250mV ±0.35%
Current	120mA ±0.1%	80mA ±0.1%	80mA ±0.1%	80mA ±0.1%	50mA ±0.1%

1. Apply accuracy specifications according to the following voltage program accuracy example:

Set a model XFR 20-60 power supply to 10 volts.

The expected result will be within the range of 10 volts ± 75mV ± 0.12% of the set voltage of 10 volts.

Table 1.3 Specifications for XFR 2800 W with GPIB-M or CANbus

Models	7.5-300	12-220	20-130	33-85	40-70
Program Resolution					
Voltage	1.16mV	1.8mV	3.08mV	5.1mV	6.2mV
Current	42.0mA	30.8mA	18.2mA	13.0mA	9.8mA
Program Accuracy ¹					
Voltage	10mV ±0.12%	50mV ±0.12%	75mV ±0.12%	75mV ±0.3%	75mV ±0.3%
Current	900mA ±0.1%	750mA ±0.1%	500mA ±0.1%	425mA ±0.1%	350mA ±0.15%
Readback Resolution					
Voltage	1.16mV	1.8mV	3.08mV	5.1mV	6.2mV
Current	42.0mA	30.8mA	18.2mA	13.0mA	9.8mA
Readback Accuracy					
Voltage	30mV ±0.12%	60mV ±0.12%	75mV ±0.12%	75mV ±0.3%	75mV ±0.3%
Current	900mA ±0.1%	750mA ±0.1%	500mA ±0.1%	425mA ±0.1%	350mA ±0.1%

Models	60-46	100-28	150-18	300-9	600-4
Program Resolution					
Voltage	9.2mV	15.4mV	23.1mV	46.2mV	92.4mV
Current	6.44mA	3.92mA	2.52mA	1.26mA	0.56mA
Program Accuracy ¹					
Voltage	150mV ±0.25%	150mV ±0.35%	225mV ±0.35%	225mV ±0.35%	250mV ±0.35%
Current	250mA ±0.1%	140mA ±0.1%	120mA ±0.1%	80mA ±0.1%	80mA ±0.1%
Readback Resolution					
Voltage	9.2mV	15.4mV	23.1mV	46.2mV	92.4mV
Current	6.44mA	3.92mA	2.52mA	1.26mA	0.56mA
Readback Accuracy ¹					
Voltage	150mV ±0.25%	150mV ±0.35%	225mV ±0.35%	225mV ±0.35%	250mV ±0.35%
Current	250mA ±0.1%	140mA ±0.15%	120mA ±0.1%	80mA ±0.1%	80mA ±0.1%

1. Apply accuracy specifications according to the following voltage program accuracy example:
Set a model XFR 20-130 power supply to 10 volts.
The expected result will be within the range of 10 volts ± 75mV ± 0.12% of the set voltage of 10 volts

Features and Specifications

Specifications

Table 1.4 Specifications for XHR 1000 W with GPIB-M or CANbus

Models	7.5-130	20-50	33-33	40-25	60-18
Program Resolution					
Voltage	1.16mV	1.8mV	3.08mV	6.2mV	9.2mV
Current	42.0mA	30.8mA	18.2mA	9.8mA	6.44mA
Program Accuracy ¹					
Voltage	10mV ±0.12%	50mV ±0.12%	75mV ±0.12%	75mV ±0.3%	150mV ±0.25%
Current	900mA ±0.1%	750mA ±0.1%	500mA ±0.1%	350mA ±0.1%	250mA ±0.1%
Readback Resolution					
Voltage	1.16mV	1.8mV	3.08mV	6.2mV	9.2mV
Current	42.0mA	30.8mA	18.2mA	9.8mA	6.44mA
Readback Accuracy ¹					
Voltage	30mV ±0.12%	60mV ±0.12%	75mV ±0.12%	75mV ±0.3%	150mV ±0.25%
Current	900mA ±0.1%	750mA ±0.1%	500mA ±0.1%	350mA ±0.1%	250mA ±0.1%

Models	100-10	150-7	300-3.5	600-1.7
Program Resolution				
Voltage	15.4mV	23.1mV	46.2mV	92.4mV
Current	3.92mA	2.52mA	1.26mA	0.56mA
Program Accuracy ¹				
Voltage	150mV ±0.35%	225mV ±0.35%	225mV ±0.35%	250mV ±0.35%
Current	140mA ±0.15%	120mA ±0.1%	80mA ±0.1%	80mA ±0.1%
Readback Resolution				
Voltage	15.4mV	23.1mV	46.2mV	92.4mV
Current	3.92mA	2.52mA	1.26mA	0.56mA
Readback Accuracy ¹				
Voltage	150mV ±0.35%	225mV ±0.35%	225mV ±0.35%	250mV ±0.35%
Current	140mA ±0.15%	120mA ±0.1%	80mA ±0.1%	80mA ±0.1%

1. Apply accuracy specifications according to the following voltage program accuracy example:
Set a model XHR 20-50 power supply to 10 volts.
The expected result will be within the range of 10 volts ± 50mV ± 0.12% of the set voltage of 10 volts.

Table 1.5 Specifications for XPD 500 W with GPIB-M or CANbus

Models	7.5-67	18-30	33-16	60-9	120-4.5
Program Resolution					
Voltage	1.2mV	4.6mV	5.1mV	9.3mV	18.6mV
Current	5.2mA	3.6mA	2.9mA	1.3mA	0.7mA
Program Accuracy ¹					
Voltage	10mV ±0.12%	75mV ±0.12%	75mV ±0.12%	150mV ±0.3%	180mV ±0.25%
Current	250mA ±0.1%	140mA ±0.1%	115mA ±0.15%	80mA ±0.15%	80mA ±0.1%
Readback Resolution					
Voltage	1.2mV	4.6mV	5.1mV	9.3mV	18.6mV
Current	5.2mA	3.6mA	2.4mA	1.3mA	0.7mA
Readback Accuracy ¹					
Voltage	30mV ±0.12%	75mV ±0.12%	75mV ±0.2%	150mV ±0.3%	180mV ±0.25%
Current	250mA ±0.1%	140mA ±0.1%	115mA ±0.15%	80mA ±0.15%	80mA ±0.1%

1. Apply accuracy specifications according to the following voltage program accuracy example:
 Set a model XPD 18-30 power supply to 10 volts.
 The expected result will be within the range of 10 volts ± 75mV ± 0.12% of the set voltage of 10 volts.

Table 1.6 Specifications for XT 60 W with GPIB-M or CANbus

Models	7-6	15-4	20-3	30-2	60-1	120-0.5	250-0.25
Program Resolution							
Voltage	1.1mV	2.4mV	3.1mV	4.7mV	9.3mV	17mV	17mV
Current	1.0mA	0.6mA	0.5mA	0.3mA	0.2mA	0.1mA	0.1mA
Program Accuracy ¹							
Voltage	10mV ±0.1%	20mV ±0.1%	20mV ±0.15%	30mV ±0.15%	200mV ±0.15%	400mV ±0.15%	400mV ±0.15%
Current	110mA ±0.15%	70mA ±0.15%	50mA ±0.15%	40mA ±0.15%	26mA ±0.2%	13mA ±0.2%	13mA ±0.2%
Readback Resolution							
Voltage	1.1mV	2.4mV	3.1mV	4.7mV	9.3mV	17mV	17mV
Current	1.0mA	0.6mA	0.5mA	0.3mA	0.2mA	0.1mA	0.1mA
Readback Accuracy ¹							
Voltage	10mV ±0.15%	10mV ±0.1%	10mV ±0.1%	15mV ±0.1%	35mV ±0.15%	70mV ±0.15%	70mV ±0.15%
Current	110mA ±0.15%	70mA ±0.15%	50mA ±0.15%	40mA ±0.15%	26mA ±0.2%	13mA ±0.2%	13mA ±0.2%

1. Apply accuracy specifications according to the following voltage program accuracy example:
 Set a model XT 15-4 power supply to 10 volts.
 The expected result will be within the range of 10 volts ± 20mV ± 0.1% of the set voltage of 10 volts.

Features and Specifications

Specifications

Section 2. Installation and Configuration

Introduction

To use this product, you must have the following equipment:

- a compatible model of DC output power supply
- IEEE-488 connector and cable
- computer with an IEEE-488 interface card
- Computer-based communications software package
- parallel CANbus cables (to connect power supply for multichannel operation)

The GPIB or CANbus interface is usually installed in a power supply at the factory. Your local distributor or service center can also install the interface, especially for use in a previously-purchased supply already on site. The interface card will be calibrated and configured with default settings. You will need to configure the supply for your system using the [“Basic Setup Procedure” on page 31](#). Refer also to [Figure 2.1, pg. 26](#), [Figure 2.2, pg. 27](#) and [Figure 2.3, pg. 27](#) for drawings of the front panels. The interface subplate is different for each product. Please check [Figure 2.4](#) to [Figure 2.7](#).

Initial Inspection



CAUTION

If you remove the unit's cover, use proper static control techniques to avoid damage to static-sensitive components on the printed circuit board.

On first receiving your unit, perform a quick inspection.

- Ensure each package contains a power supply with its GPIB interface board installed, and manuals for the power supply and the GPIB interface. A custom CANbus cable and a terminator are also supplied with each GPIB-M or CAN-only interface. Any additional parts shipped with the power supply will be identified in the supply's documentation.
- Inspect the unit for any signs of physical damage such as scratches, cracks, or broken switches, connectors, or displays.
- Check the printed circuit board and components if you suspect internal damage.

If the unit is damaged, save all packing materials and notify the carrier immediately. For additional information, please see the section titled, “Returning Power Supplies to the Manufacturer” in the manual shipped with your complete unit.

Installation and Configuration

Initial Inspection



CAUTION

Use proper static control techniques to avoid damage to static-sensitive components on the printed circuit board.

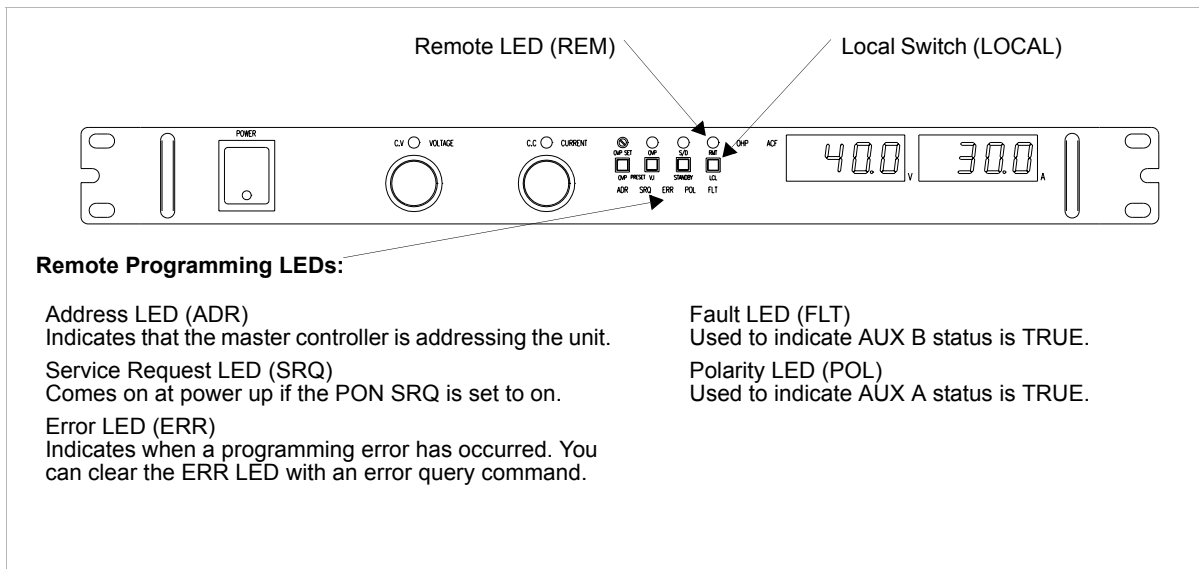

Figure 2.1 XFR and XHR Power Supply Front Panel with GPIB-M Interface
(XFR 1200 Watt model shown)

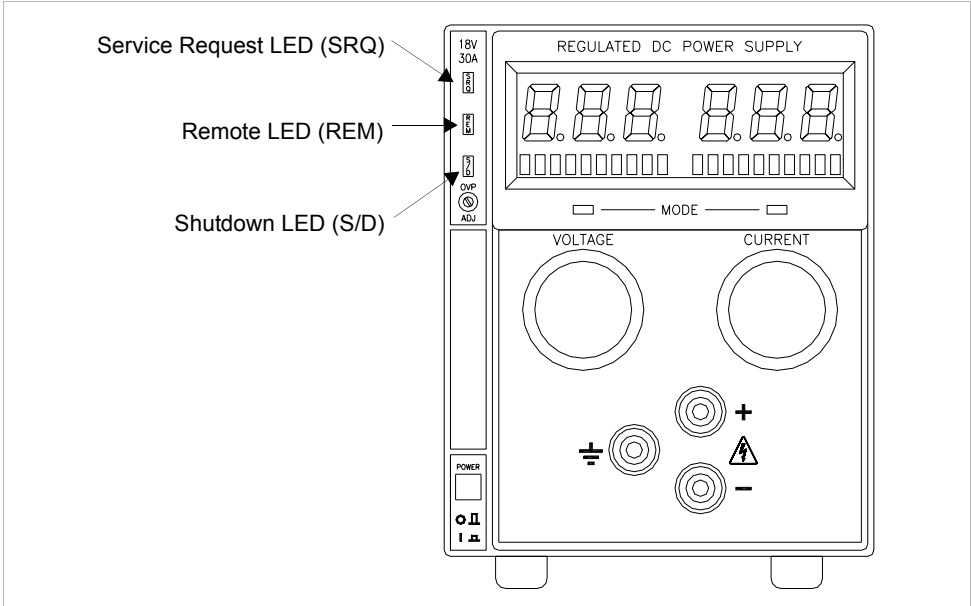

Figure 2.2 XPD Power Supply Front Panel with GPIB Interface

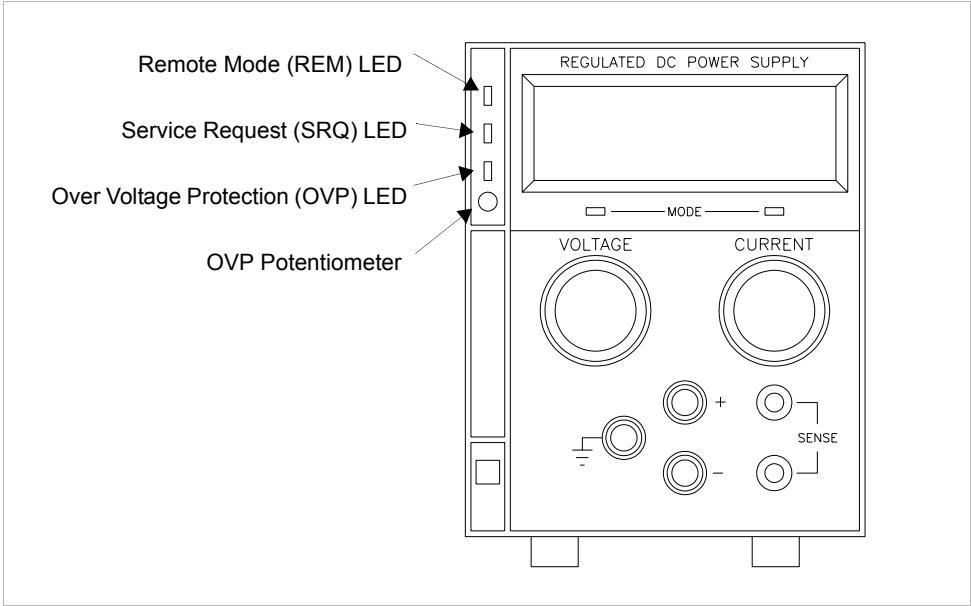

Figure 2.3 XT and HPD Power Supply Front Panel with GPIB Interface

Installation and Configuration

Initial Inspection

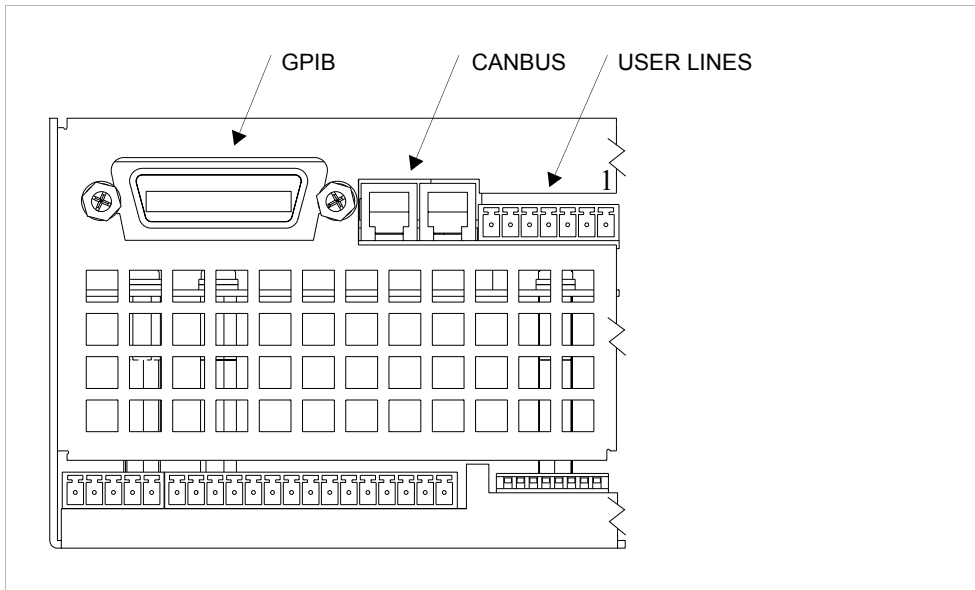

Figure 2.4 XFR 2800 Watt Power Supply Rear Panel with GPIB-M Interface

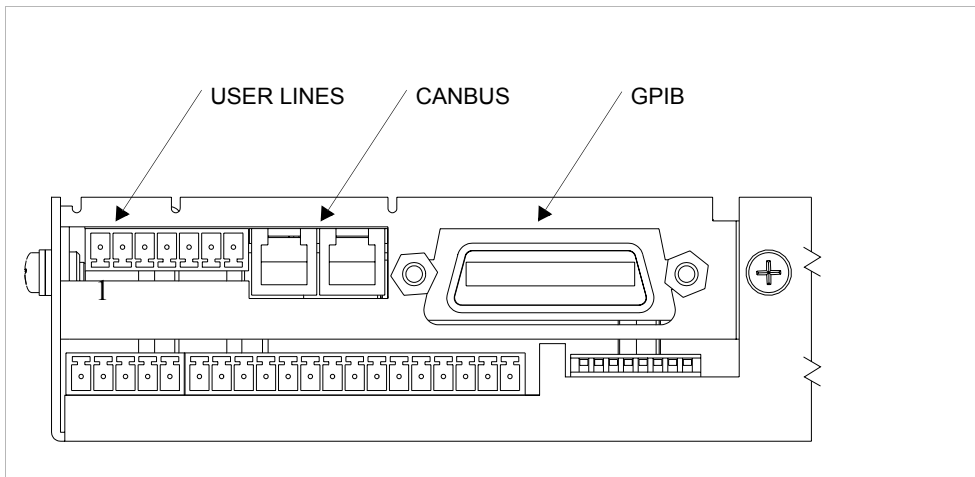

Figure 2.5 XFR 1200 Watt Power Supply Rear Panel with GPIB-M Interface

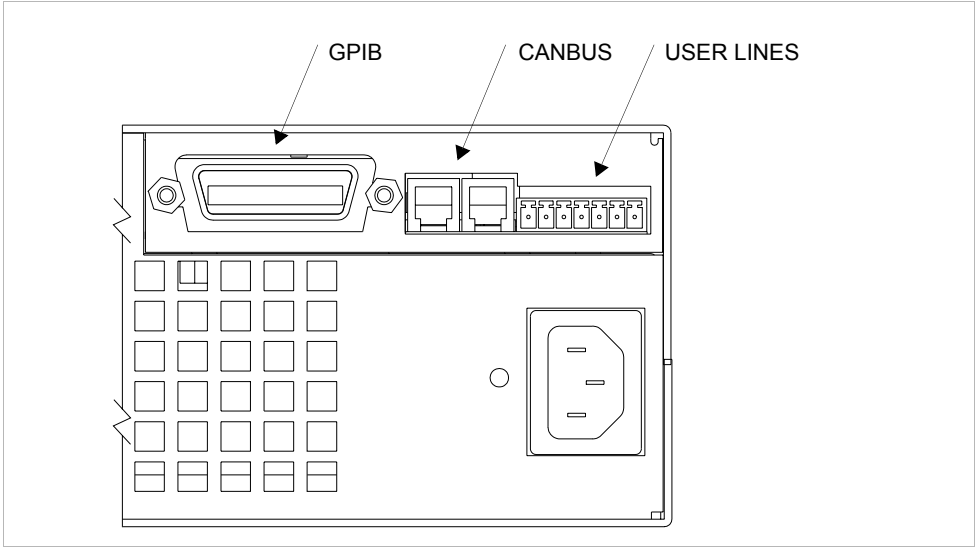

Figure 2.6 XHR Power Supply Rear Panel with GPIB-M Interface

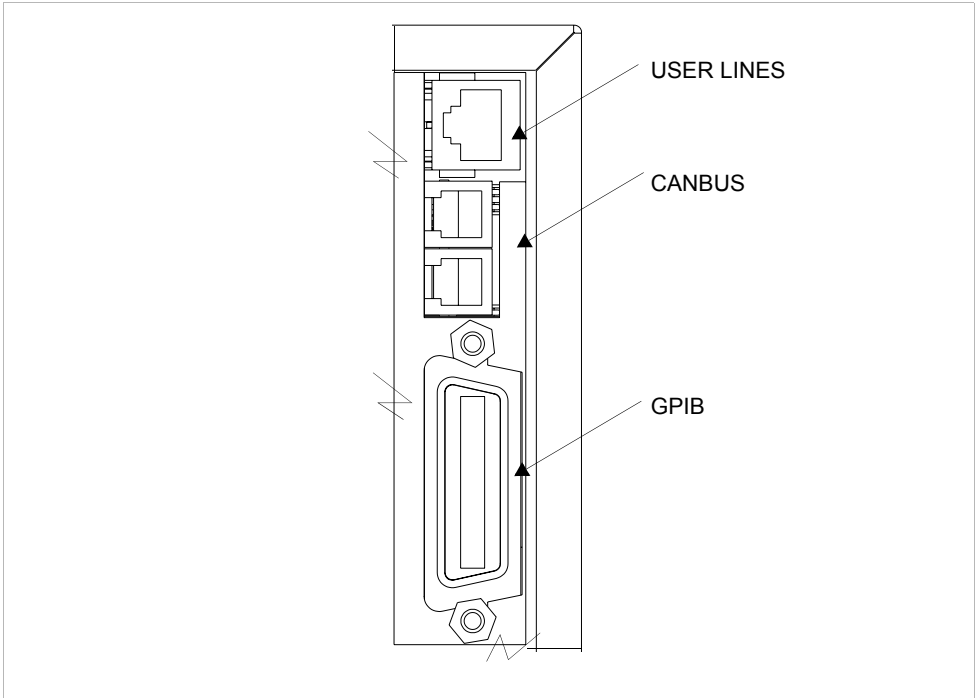

Figure 2.7 XPD Power Supply Rear Panel with GPIB-M Interface

Installation and Configuration

Initial Inspection

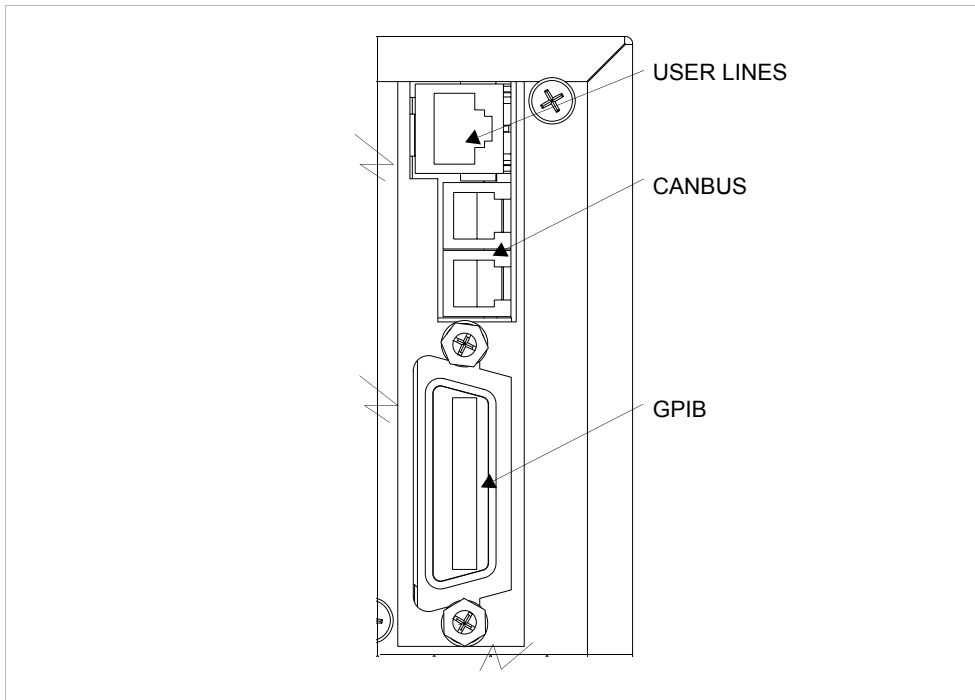

Figure 2.8 XT/HPD Power Supply Rear Panel with GPIB-M Interface



CAUTION

Use proper static control techniques to avoid damage to static-sensitive components on the printed circuit board

Basic Setup Procedure

This procedure can be used as a quick reference for those familiar with the configuration requirements for the GPIB-M interface as installed in the DC power supply.

IEEE-488 Controller Connection

Connect the GPIB cable to the supply at connector on the rear panel. Use an approved IEEE-488 connector and cable when connecting the GPIB Interface to your IEEE-488 GPIB network. Refer to [Figure 2.4](#), [Figure 2.5](#), [Figure 2.6](#) or [Figure 2.7](#).

Add a ferrite block to reduce radiated emissions. The one inch square ferrite block with built-in housing clip is packaged and shipped with the power supply interface card.

To install the ferrite block:

1. Position the block no more than 5 cm (2 in.) from the power supply end of the user cable.
2. Open the ferrite block housing.
3. Run the cable through the ferrite block. See [Figure 2.9](#), “XFR GPIB Cable with Ferrite Block” on page 31.
4. Close the housing clip.

The ferrite block ensures that the power supply system meets radiated emission requirements for CE mark.

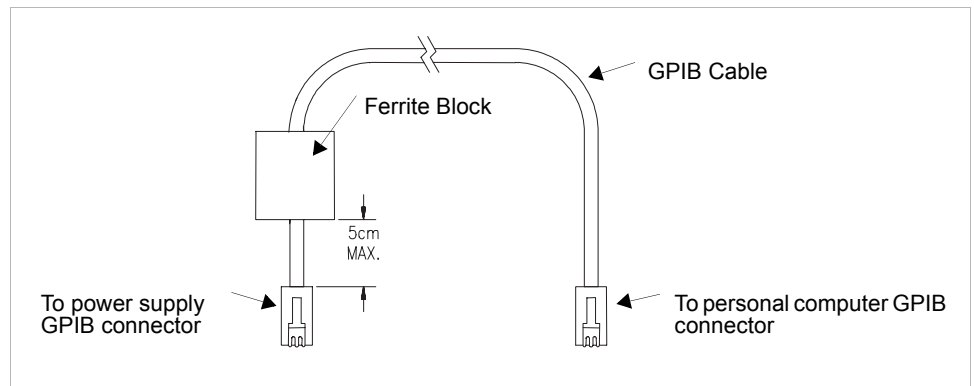

Figure 2.9 XFR GPIB Cable with Ferrite Block

Installation and Configuration

Basic Setup Procedure

Setup Procedure For those who want more information, each step refers to more detailed procedures located in subsequent sections.

1. **Power ON**

Power on the unit.

2. **Configure Computer Controller**

Configure the controller to match the power supply characteristics. The unit is shipped with default GPIB address 2. Configure your controller to talk to address 2.

3. **Test**

Test the link by communicating with the power supply.

Example: Send the ID query “*IDN?” and ensure you get a response. Send the command “:VOLT 2;:CURR 1” to set voltage to 2V and current limit to 1A.

(Using IBIC¹ this would be ‘ibwrt “:volt 2;:curr 1”’)

See [“Change Remote/Local Mode” on page 48](#) for information about changing about Local/Remote modes.

4. **Configure power supply**

If desired, configure the power supply with the desired power on settings or a different GPIB address. (Be sure to change the controller address to match.)

See [“Power On Remote State” on page 49](#), [“Set Up Power ON Defaults” on page 56](#), and [“Power On Output State” on page 57](#).

1. This text uses National Instruments' IBIC (Interface Bus Interactive Control) program commands developed for their GPIB interface for computer controllers as examples only.

Table 2.1 Remote Mode Power On Conditions

Feature	Factory Preset Value
Voltage setpoint	0.0V
Current setpoint	0.0A
Triggered voltage setpoint	Disabled (Default)
Triggered current setpoint	Disabled (Default)
Trigger source	None
Low voltage setpoint limit	0.0V
High voltage setpoint limit	103% of voltage rating
Low current setpoint limit	0.0A
High current setpoint limit	103% of current rating
Over voltage protection	Disabled (0.0V)
Under voltage protection	Disabled (0.0V) and not shutdown when tripped
Over current protection	Disabled (0.0A) and not shutdown when tripped
Under current protection	Disabled (0.0A) and not shutdown when tripped
Fold shutdown protection	None and delay 0.5s
AC OFF shutdown recovery	Auto recover
OTP shutdown recovery	Latched
Aux line configuration	None and active low



CAUTION

Ensure the power supply chassis is properly connected to ground. The interface connection system is not capable of handling the resulting excessive ground currents that may flow through the connection to the controlling computer if the chassis is not at ground potential.

Power On Service Request

The Power On Service Request setting causes the power supply to send a service request to the computer controller when the power supply is turned on or when it re-initializes after a momentary power interrupt if the following conditions are also met:

- *PSC (power on status clear) is set to 0, and
- bit 5 in the Service Request Enable register has been set (*ESE) prior to power off.

When a service request is sent, the front panel SRQ LED will also turn on. You can clear the service request and turn off the SRQ LED by performing a serial poll. See also “[Status Byte](#)” on page 79 for information about the SRQ command.

Installation and Configuration

Configure for GPIB Operation

Configure for GPIB Operation

The power supply is ready for GPIB communication when it leaves the factory, but you may change any of the control settings. The default remote control setting is GPIB, address 2.

Change Remote Control Source Select an interface for remote control.
SYST:REM:SOUR [GPIB|MCHannel]

where

- GPIB : control via GPIB interface
- MCHannel : multichannel operation using the CANbus interface

Set GPIB Address Change the GPIB address.
SYST:COMM:GPIB:ADDR <GPIB-address>

where

<GPIB-address> may be a value from 1 to 30.

Be sure to make a note of the GPIB address. If the address is unknown, use a feature such as “Scan for Instruments” on National Instruments’ Measurement and Automation Explorer.

Configure for Multichannel Operation

Multichannel Connections You may remotely control up to 50 power supplies from one GPIB interface by using multichannel addressing via the CANbus.

One power supply will be connected to a PC via GPIB. All other power supplies are connected via CANbus (Controller Area Network) to that unit. SCPI commands that include a channel address will be sent via the CANbus to the other power supplies. (Commands with the local address will be executed locally and will not be sent).

The multichannel address must be appended to the program mnemonic. If no multichannel address is appended to the program mnemonic, the command is executed by the local (directly connected) power supply.

Each unit of the network can send and receive commands to and from other units on the network. It is highly recommended that only one command be sent at a time. Any GPIB timeout settings should be increased when using multichannel commands.

Multichannel Configuration If a second power supply that has the same multichannel address as another is connected to the bus, it will automatically increment its address until it finds a unique address. If it fails to find a unique address, it will disconnect itself from the bus and you will not be able to communicate with it until you disconnect the other power supplies and cycle the power. Therefore, when configuring a network of supplies, you can make all connections, and power on one supply at a time. They will configure their addresses in the order that they were powered on. Be sure to note the address of each power supply for future reference or in case you want to reorganize the network.

Example:

Connect 3 power supplies for multichannel operation. You have one GPIB-M supply and 2 CAN-only supplies. The GPIB-M supply's multichannel address is set to 1 at the factory. Both CAN-only supplies are set to 2.

Connect all units as described in [“Basic Setup Procedure”](#) on page 31.

Power on the GPIB-M supply, then one of the CAN-only supplies. Check that you can communicate with both. Send the *IDN? query to return the identification string from the GPIB-M supply. Send "SYST2 : IDEN?" to return the ID string from the CAN-only unit.

Power on the last unit. Since multichannel address 2 already exists on the bus, it will automatically configure itself to address 3. Check that this is the case by sending the command "SYST3 : IDEN?"

Installation and Configuration

Configure for Multichannel Operation

CANbus The CANbus port consists of two 4-pin modular “handset” jacks to support daisy chain connections. The CAN (Controller Area Network) is an ISO standard (ISO11898) for a serial communication network. [Table 2.2](#) describes the pin functions. The CANbus is used for communications in multichannel operation or current sharing (master/slave) operation.

Table 2.2 CANbus Pins

Pin #	Function
1	CANLO
2	Ground
3	CANHI
4	Ground

CANbus Cables The custom CANbus cables shipped with your unit are parallel 4-connector cables with 4-pin modular “handset” connectors.

Configuration of CAN-only Interface Cards The CAN-only interface cards must be configured via the CANbus with another GPIB-M card. The CAN-only interface cards are set to multichannel address 2 at the factory. Ensure the multichannel address on the GPIB-M is set to an unused address, for example, address 1. Connect the two power supplies as shown in [Figure 2.10](#), “Connections for Multichannel Operation” on page 37.

Send the query to the CAN-only power supply:

```
SYST2:REM:SOUR?
```

and ensure the response is “MCH” for multichannel.

If necessary, set the power supply to accept control via multichannel commands (the CANbus interface) with the SCPI command:

```
SYST2:REM:SOUR MCH
```

Set each slave's unique multichannel address using the command:

```
SYST2:COMM:MCH:ADDR <multichannel-address>
```

where multichannel-address is an integer in the range of 1-50.

This procedure can be repeated separately with each power supply to assign a unique address to each. Once all power supplies are configured, they can be connected to the CANbus network.

Note See “[Broadcasting Commands](#)” on page 39 for additional information on configuring CAN-only units.

Setup See [Figure 2.10](#).

1. Connect power supplies to be controlled via the CANbus network. Connect the power supplies in a daisy chain by linking the first power supply to the second using one cable, and then the second to the third using a second cable and the second CAN port. Continue making connections in this fashion until all the power supplies are connected. Terminate the bus at both ends, using the unused CAN ports, with 120 ohm, 1/4 Watt resistors (included) across the CAN HI and CAN LO signals (Pins 1 and 3). See Table 2.2, "CANbus Pins," on page 36.
2. At least one power supply must be connected to a PC via GPIB for multichannel functionality. Configure each of the power supplies with a unique address, as described in the configuration section. Addresses may be in the range 1 to 50 inclusive. Record the address of each unit for future reference.
3. Turn the power supplies on one at a time.

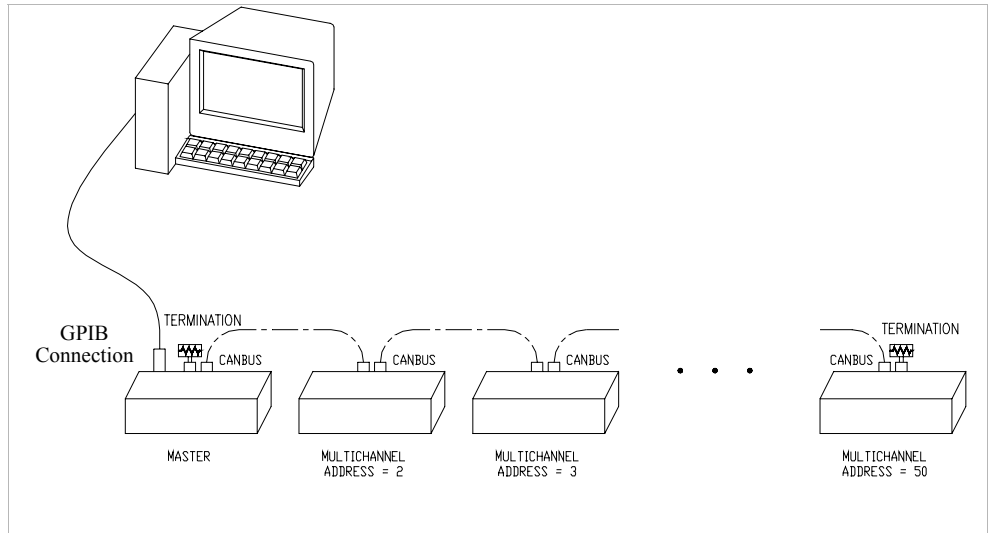

Figure 2.10 Connections for Multichannel Operation

Using Multichannel Operation

Once the power supplies have been configured and connected, you may power them on.

Power supplies controlled via multichannel have full capabilities, including changing REM/LCL modes and calibration.

Any power supply may send multichannel commands, if they are connected to a PC via GPIB.

Installation and Configuration

Configure for Multichannel Operation

A power supply will attempt to connect to the network:

- on power up, and
- when the multichannel address is changed.

The power supply will successfully connect if there are no other power supplies on the network with the same address.

Error 1702, "Multichannel address taken" is queued if the power supply fails to connect.

SCPI Remote Control (RCONtrol) subregister will indicate the status of the connection. A power supply that has been disabled will not have any bits set. Use the SCPI command:

```
STAT:OPER:RCON:COND?
```

to query the condition of the multichannel interface.

See Table 4.5, "Remote CONtrol Sub-Register," on page 74 for a description of the bits in this register.

Multichannel Commands

To send a command to a multichannel power supply, attach the channel address to the command. If no channel number is specified, the command will be executed by the directly connected power supply.

For example, the command:

```
SOURce12:VOLT 10.0
```

will set the power supply with address 12 to 10V output. The master receives the command and puts in on the CANbus.

[Appendix B. "SCPI Command Reference"](#) lists all commands.

[<channel>] indicates where the multichannel address is to be inserted into the command.

IEEE488.2 commands have been given an alias that is SCPI compliant if the command is applicable to a power supply in multichannel operation. These commands include *CLS, *IDN?, *OPT?, *RST, *TST?, *RCL, *SAV, *SDS, and *WAI. See Table B.1, "IEEE 488.2 Commands," on page 104.

Note The multichannel interface can not handle multiline response messages.

Broadcasting Commands You can specify a channel address of "0" to broadcast a command to all power supplies connect via CANbus. Broadcast commands are useful in set up and operation.

Example:

Set all power supplies to remote mode:

```
SYST0:REM:STAT REM
```

Turn output on:

```
OUTP0 ON
```

Set voltage output to maximum:

```
SOUR0:VOLT MAX
```

Attempting to broadcast any query will generate an error.

Note Broadcasting may be useful in configuring a CAN-only power supply when its address is unknown. Connect the unit to a GPIB-M power supply. Broadcast the set multichannel command to change the CAN-only supply's address. The command has no effect on the GPIB controlled unit.

Example: "SYST0:COMM:MCH:ADDR 2" will set the CAN-only unit to address 2.

Note that there will be a lag in execution time between the local unit and all other units of up to a maximum of 20 ms.

Specifications

Max connected units	50
Max cable length	40 m
Bus speed	700 kbits/sec
Termination	120 ohm 1/4 W
Connectors	modular handset 4-position, 4-contact jacks
Addresses	1 to 50

Installation and Configuration

User Lines

User Lines

The user lines connector, located on the GPIB-M interface rear panel, provides several signals to increase your operating control of the supply. These signals are dependent on the operator's design and uses. The operation of the auxiliary status lines requires that you provide external Vcc and ground. To locate the connector, refer to [Figure 2.4](#), [Figure 2.5](#), [Figure 2.6](#) and [Figure 2.7](#). See [Figure 2.13](#), “Schematic For User Line Interface” on page 42 and [Table 2.3](#), “User Line Pins,” on page 40 for pin descriptions.

The user lines are optically isolated, open collector configuration. The input lines are capable of sinking 10mA (with recommended 5V at input) up to a maximum of 90mA.

XT/HPD and XPD: The connector for the user lines is a standard 8-conductor RJ45 jack. The cable is supplied by the user.

XFR or XHR: The connectors are removable “wire clamp” terminal block style connectors. Use shielded twisted pairs of 22-24 AWG wire for connections. Strip 0.2” (5mm) of insulation from the wires and clamp securely at the appropriate pin.

Table 2.3 User Line Pins

Pin #	Function	Input/Output
1	Aux Status Line A	Output
2	Aux Status Line B	Output
3	External Trigger 4-12V	Input
4	Safety Interlock (Shutdown) 4-12V	Input
5	Safety Interlock (Shutdown) GND)	Input
6	User Power, 5-12Vdc	Input
7	User Ground	Input

User Lines Connection (XT, HPD, XPD)

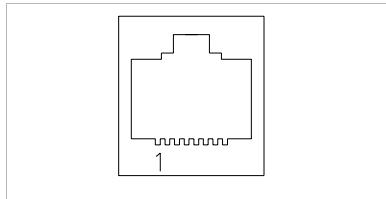

Figure 2.11 User Signals Connector (XT, HPD and XPD)

Use a standard 8-conductor RJ45 connector and data cable to connect to the user lines.

Add a ferrite block to reduce radiated emission. The one inch square ferrite block with built-in housing clip is packaged and shipped with the power supply interface card.

To install the ferrite block:

1. Position the block no more than 5 cm (2 in.) from the power supply end of the user cable.
2. Open the ferrite block housing.
3. Loop the cable through the ferrite block. See [Figure 2.12, “XT, HPD, XPD User Cable with Ferrite Block”](#) on page 41.
4. Close the housing clip.

The ferrite block ensures that the power supply system meets radiated emission requirements for CE mark.

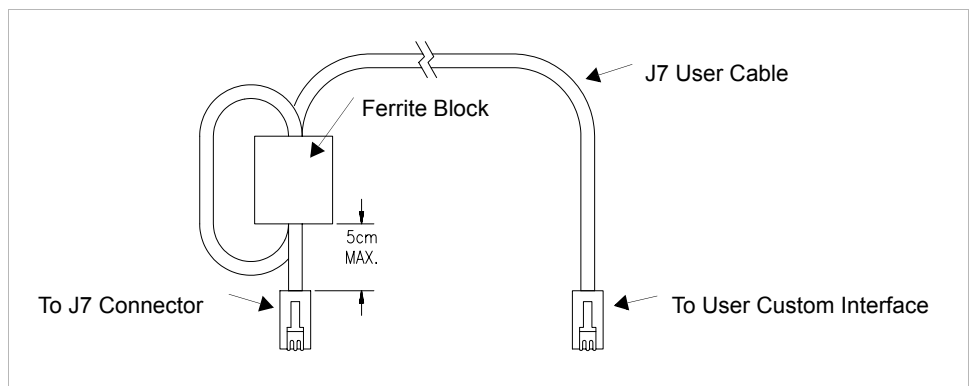

Figure 2.12 XT, HPD, XPD User Cable with Ferrite Block

Installation and Configuration

User Lines

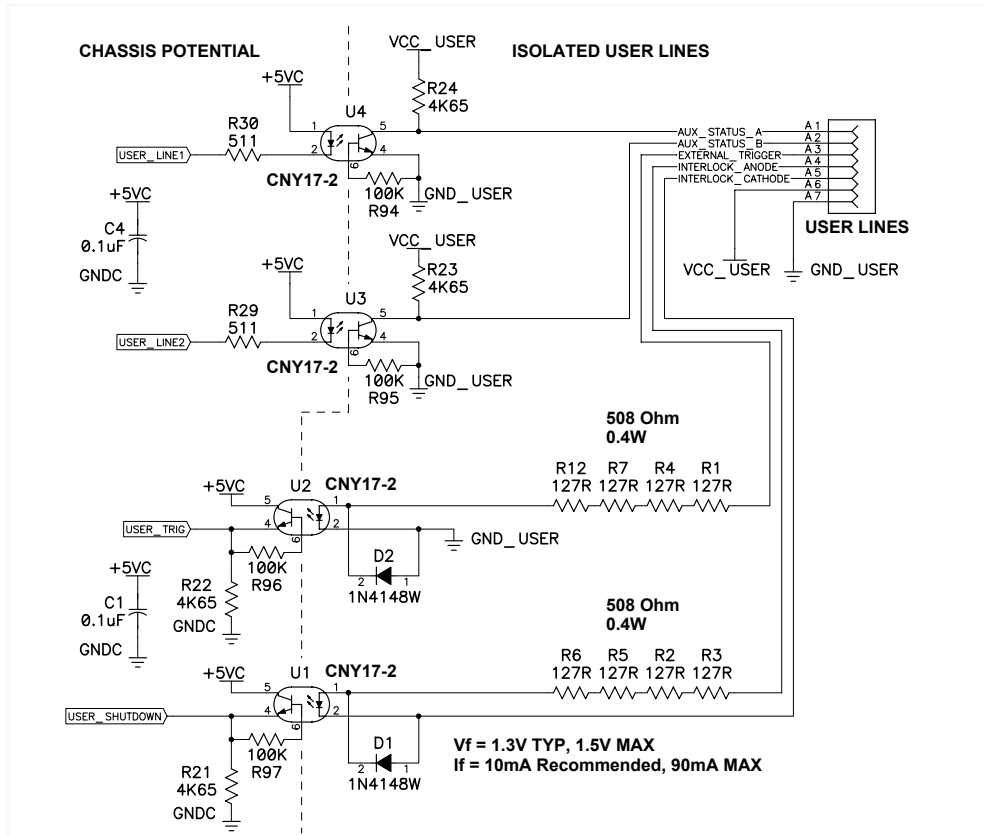

Figure 2.13 Schematic For User Line Interface

Section 3. Operation

Overview

Once you have installed the power supply and connected both the AC input power and the load as explained in [Section 2](#), the power supply is in its default configuration and is ready for operation.

One power supply must be connected via GPIB. Additional units may be controlled via the CANbus port which enables multichannel addressing. The multichannel addressing also supports the current sharing feature for parallel-connected units. Any unit may be toggled between remote and local control modes.

[Section 3](#) provides information about operating the power supply remotely via the GPIB-M or CAN-only optional interface.

In addition, brief descriptions are provided of Constant Voltage and Constant Current modes. See [“Power Supply Operation” on page 48](#).

Powering ON the Power Supply



WARNING- Shock Hazard

The factory setting for Power ON is 0V and 0A with the output OFF. These settings can be customized by end users. If you suspect that the power supply has been used by someone else since it was received from the factory, be prepared for the unit to power ON with a live DC output.

To power on the power supply:

1. Ensure that the AC power switch is OFF.
2. Connect the unit to an AC outlet.
3. Turn on the front panel AC power switch.

After a short power-on delay, the digital meters on the front panel and the CV LED illuminate.

Operation

Power Supply Operating States

Power Supply Operating States

The power supply has 5 operating states:

- Power-On
- Output Shutdown
- Soft Start
- Normal Operation
- Calibration

Power-On This is the period between the time that AC power is applied to the supply (AC breaker turned on) and the time that the power supply is ready for operation. During this period, the internal circuits are powering up and performing self-tests. At the end of the Power-On period, the supply is normally in its default Power-On mode with the output OFF, $V_{SET}=0$ and $I_{SET}=0$.

Output Shutdown In this state, the output is disabled and there is no output regardless of power settings. The power supply can be placed in the Output Shutdown state by a command (or the front panel - XFR, XHR only), via the Interlock signal, or from a protection mechanism. This is also called the Standby mode.

Soft Start In this state, the output power is ramping up gradually towards its target load. This reduces equipment stress. This state occurs whenever the supply output is enabled by the software (a command or a protection is cleared), and is approximately 2 seconds in duration. See [“Slew Rate” on page 67](#) to change the properties of the ramp.

Normal Operation This is the normal operating state for the power supply. The power supply is ready to accept commands.

Calibration This is a service mode that is used to calibrate setpoints and readback levels for accuracy. Calibration should only be performed by qualified service personnel.

Power Supply Regulation Modes

The power supply has 2 regulation modes while in the Normal Operation State:

- Constant Voltage (CV)
- Constant Current (CC)

The CV, CC LEDs on the front panel indicate the regulation mode.

- Constant Voltage (CV)** In this mode, the supply's output voltage is constant while the current and power vary with the load. The power supply will operate in constant voltage mode whenever the load current I_L is less than the current limit setting I_{SET} , or: $I_L < I_{SET}$ ($I_L = V_{SET}/R_L$). In constant voltage mode, the power supply maintains the output voltage at the selected value (V_{SET}) while the load current I_L varies with the load requirements.
- Constant Current (CC)** In this mode, the supply's output current is constant while the voltage and power vary with the load. The power supply will operate in constant current mode whenever the load resistance is low enough that the load current I_L is equal to the current limit setting I_{SET} . ($V_L = I_{SET}R_L$). In constant current mode, the power supply maintains the output current at the selected value (I_{SET}) while the load voltage V_L varies with the load requirements.
- Automatic Mode Crossover** This feature allows the power supply to automatically switch operating modes in response to changing load requirements. If, for example, the power supply was operating in Constant Voltage (CV) Mode ($I_L < I_{SET}$), and the load changed so the load current (I_L) became EQUAL TO the current limit setting (I_{SET}), the power supply would automatically switch into Constant Current (CC) Mode and the output voltage would vary in response to changes in load current. If the additional load was subsequently removed so the load current was again LESS THAN the current limit setting, the supply would automatically return to Constant Voltage (CV) Mode.

Operation

Remote Control Modes

Remote Control Modes

The power supply must be in remote mode to execute commands. The remote mode is indicated by the front panel remote status LED. A power supply will respond to queries when in local mode, but will generate an error when a command is received. GPIB equipped supplies will automatically transition from local to remote mode when any command data is received. CANbus-only supplies may have to be put into remote mode with a command before sending any other command. See [“Change Remote/Local Mode” on page 48](#).

The factory default power-on settings are given in [Table 3.1, on page 46](#).

Table 3.1 Power Supply Factory Defaults

Power Supply	Default Remote State	Default Output State (Shutdown)
XFR or XHR	Remote	OFF
XPD	Local	ON
XT or HPD	Local	ON

You can change the default Remote/Local state, see [“Power On Remote State” on page 49](#).

If safety is an issue because the front panel control knobs may be set to hazardous voltages at power on, contact the factory to order locking bushings for the knobs.

See your power supply’s operating manual for details on using the power supply in local mode.

Front Panel LEDs

The status LEDs on the front panel give an instant indication to the status of the power supply.

LED	Description
REM	Unit is operating under remote control. Remote settings apply.
SRQ	Unit is requesting service
S/D	Unit is in shutdown due to tripped protection mechanism, command, or interlock

In addition, the XFR and XHR series power supplies have the following additional indicators.

LED	Description
ERR	Unit has encountered an error
ADR	Unit is receiving a command
OVP	Unit is shutdown due to a hardware over-voltage condition.
OTP	Unit is shutdown due to an over-temperature condition.
ACF	Unit is shutdown due to an AC input failure condition (AC line may be high or low.)
POL	Used to indicate the AUX A status condition is true.
FLT	Used to indicate the AUX B status condition is true.

Operation

Power Supply Operation

Power Supply Operation

This section describes how to configure and operate the power supply.

For a complete list of commands and remote functionality, see [Appendix B. “SCPI Command Reference”](#). Read [“Understanding SCPI Commands” on page 99](#) for a better understanding of SCPI commands.

Almost every command setting can be queried to return the current setting. The query is given by appending a “?” to the command header (the command, minus any parameters).

Change Remote/Local Mode

A SCPI command is provided to change the remote/local mode. (GPIB can also use IEEE 488-1 functions to change modes.)

```
SYST:REM:STAT {LOC|REM|RWL}
```

Where:

- LOC: go to local mode operation
- REM: go to remote mode operation
- RWL: remote with local lockout. Go to remote mode operation with local mode locked out. With RWL set, the user cannot return to local mode via the front panel. RWL is only valid for XFR/XHR series power supplies. Local lockout will not allow the user to return the power supply to local operation using the front panel LOCAL button.

To query to remote mode:

```
SYST:REM:STAT?
```

XFR and XHR series power supplies have a LOCAL key that allows you to shift control to local mode except if the power supply has Local Lockout (LLO) active.

Changing the remote/local state:

When entering local mode, the option card will clear all protections and re-enable the bridge since software protections cannot be cleared at the front panel. When returning to remote, the command shutdown will be reasserted if it was set when the unit was last in remote mode.

Software protection settings and configurations (over voltage, under voltage, over current and under current levels, and AC Fail, over temperature and fold configurations) are ignored while in local mode.

The functionality of the hardware protection circuits (OVP, OTP, ACFail) remains the same in local mode.



WARNING

When returning to remote mode, the remote protection setpoints may trip even though the remote setpoints would not normally cause the unit to shutdown. This is because the output transient in settling to the remote settings from the local settings may cause a trip condition. Once cleared, the unit will operate normally.

Note: There will be no status reporting of OVP, interlock, sense, OT or AC protections while the unit is in local mode since software protections cannot be cleared at the front panel.

Power On Remote State (XFR/XHR and XPD only) You may set whether the power supply powers on in remote or local mode

SYST:REM:PON:STAT <on-off-state>

Enable Output When the output is disabled, the S/D LED on the front panel will be lit and a bit in the shutdown register will be set.

To enable or disable the output:

OUTP [<channel>] {ON|OFF|0|1}

Setting the output state to "ON" will attempt to clear all shutdown bits (except the interlock). Previously, it only cleared a shutdown caused by a command (i.e. "OUTP OFF").

To query the state of the output enable:

OUTP?

The output state query returns "0" if the output is disabled for any reason (e.g. protection tripped or command shutdown) and "1" only if the output is enabled.

Set Voltage and Current SOUR:VOLT <voltage>
SOUR:CURR <current>

To check your settings:

SOUR:VOLT?
SOUR:CURR?

Operation

Power Supply Operation

Readback To check the voltage or current output of the power supply, use the commands:

```
MEAS : VOLT?
```

```
MEAS : CURR?
```

Units are in volts and amps, respectively.

Example:

To set voltage to 5.5V and current limit to 100A, send the command:

```
:VOLT 5.5 ; :CURR 100
```

Then check the output:

```
MEAS : VOLT? 5.500 (example readback, default unit V)
```

```
MEAS : CURR? 0.010 (example readback, default unit A)
```

**Configure
Output
Protection**

Five configurable protection mechanisms are available:

- **OVP:** Over-Voltage Protection. Factory default = 0V (disabled)
- **UVP:** Under-Voltage Protection. Factory default = 0V (disabled)
- **OCP:** Over-Current Protection. Factory default = 0A (disabled)
- **UCP:** Under-Current Protection. Factory default = 0W (disabled)
- **Fold:** Fold Protection. (See below.)

OVP shuts down the power supply if the protection limit is exceeded. The other options offer a choice: they shut down the power supply or issue a warning by setting a bit in the status register. Set the protection mechanism to ON to enable it to shutdown the power supply.

When the protection level is set to zero, that mechanism is disabled. However, in the case of OVP, a fixed hardware protection mechanism still exists to protect the supply from damage.

To set the over-voltage protection level:

SOUR:VOLT:PROT <voltage>

To set the under-voltage protection level:

SOUR:VOLT:PROT:UND <voltage>

To enable UVP shutdown:

SOUR:VOLT:PROT:UND:STAT <on-off-state>

To set the over-current protection level:

SOUR:CURR:PROT <current>

To enable OCP shutdown:

SOUR:CURR:PROT:STAT <on-off-state>

To set the under-current protection level:

SOUR:CURR:PROT:UND <current>

To enable UCP shutdown:

SOUR:CURR:PROT:UND:STAT <on-off-state>

To check if a protection mechanism was tripped:

SOUR:VOLT:PROT:OVER:TRIP?

SOUR:VOLT:PROT:UND:TRIP?

SOUR:CURR:PROT:OVER:TRIP?

SOUR:CURR:PROT:UND:TRIP?

Alternatively, you can query the status register. See [Appendix B. “SCPI Command Reference”](#).

Operation

Power Supply Operation

OVP The over voltage protection level is set with a command for remote mode and with the front panel potentiometer for local mode. If operating in remote mode, and the OVP is disabled by setting the trip level to 0, a second hardware OVP circuit, fixed at approximately 115%, may trip and shutdown the unit. If this occurs, either shutdown the unit, or toggle the output with a command, the interlock or front panel S/D button to clear the OVP circuit.

OVP operation will remain the same for local mode. Specifically, it will be controlled via the front panel potentiometer. The OVP LED will indicate if OVP has been tripped. Either pressing the S/D button, or asserting the interlock will clear the OVP condition and the unit resumes normal operation when the respective signal is removed.

Fold Protection Fold Mode protection will shut the power supply down when the unit enters the selected regulation mode for a specified period of time.

A programmable delay time causes the supply to wait before shutting down the output.

To set the fold mode:

```
OUTP:PROT:FOLD {CC|CV|NONE}
```

Where:

- NONE indicates fold protection is disabled.
- CC indicates the supply will shut down due to constant current condition.
- CV indicates the supply will shut down due to constant voltage.

The default value is NONE.

To set the fold delay:

```
OUTP:PROT:FOLD:DEL <delay_time>
```

Where:

<delay_time> is a value in the range of 0–60 seconds.

Units may be specified as “ms” (milliseconds) “s” (seconds), or “min” (minutes). If no units are specified, the default seconds are assumed. (Increments of 0.1s are allowed.) The default value is 0.5 second.

- Additional Protections** Other protection mechanisms designed to protect the power supply are:
- **AC Off:** Disables the output if the AC line drops below the acceptable range.
 - **Sense Protection:** Disables the output when the internal sense circuit is tripped by either reversed polarity at the output of the supply or a high voltage present at the output.
 - **Output Fail:** Disables the output if the bridge circuit fails. This is a hardware protection circuit and has no associated software controls.

- Set Shutdown Recovery for AC Off** There are two options for AC Off (ACO) and Over-Temperature protection (OTP):
- **Auto-Recovery:** With this method, the power supply returns to its normal operating state once the alarm condition no longer exists. For example, if there was an over-temperature alarm and the protection was set to auto-recovery, the power supply would return to its normal operating state once the temperature was reduced below the alarm level.
 - **Latched:** With this method, the power supply remains in Shutdown state until the operator manually clears the protection and manually turns the output back on.

AC Off Protection The user has the option of setting whether the AC Off protection mechanism is latched or automatically resumes operation.

`SENSE : VOLT : AC : PROT : LATCH { ON | 1 | OFF | 0 }`

Where:

- ON or 1 means the supply will be latched in shut down if an AC Off condition occurs, until the user re-enables the output, and
- OFF or 0 means the supply will automatically resume operation when the AC line input returns to normal.

The default value is OFF.

To query if AC Off has tripped:

`SENSE : VOLT : AC : PROT : TRIP?`

Over Temperature Protection The user has the option of setting whether the OTP mechanism is latched or automatically resumes operation.

`SENSE : TEMP : PROT : LATCH { ON | 1 | OFF | 0 }`

The default value is ON.

To query if OTP has tripped:

`SENSE : TEMP : PROT : TRIP?`

Operation

Power Supply Operation

Clear Protection Event If the unit has shut down, resume operation by sending the "OUTP ON" command.
To support older revisions of firmware (1.5 and older),
[:]OUTPut [<channel>]:PROTection:CLEar command will still be
parsed and passed to other instruments on the CANbus.



WARNING- Fire Hazard

If an over-voltage or over-current protection error persists without apparent cause, disable the output, and turn the AC switch OFF. Inspect the load and power supply for evidence of an electrical fault. The power supply should not be brought back into operation if there is any evidence of an electrical fire or other safety hazards.

Shutdown vs Protection Alarm

If a protection setpoint is exceeded, the system does the following:

1. If :STATe has been set to ON, the unit shuts down.
(OVP does not have a settable :STATe. It is always ON.)
2. If :STATe has been set to OFF, the unit does not shut down but creates an alarm by setting the appropriate bit in the questionable status register, which can be queried remotely. See [“Status Registers” on page 69](#) for more information.

**User Settings
(Save and
Recall)**

If you have a frequent or constant need for a specific voltage and current output, you can save these setpoints in the power supply's memory as a user setting. Once a setting is stored, it remains in the power supply's memory after the unit is powered off.

Ten user setting memory locations are available, and each saves the following parameters:

- Voltage setpoint
- Current setpoint
- Over-voltage protection setpoint (OVP)
- Under-voltage protection setpoint and shutdown configuration (UVP)
- Over-current protection setpoint and shutdown configuration (OCP)
- Under-current protection setpoint and shutdown configuration (UCP)
- Foldback protection mode and delay settings
- AC Off auto recovery configuration (ACO)
- OTP auto-recovery configuration
- Aux line configuration
- Voltage and current soft limits
- Triggered setpoints and trigger source

Note All parameters are saved and used when the user setting is recalled. Therefore, you should set parameters that you do not care about to the factory defaults.

To store (save) settings:

*SAV <user-setting>

or the SCPI equivalent for multichannel addressed units

SYST<channel>:SAVE <user-setting>

where <user-setting> is an integer from 1 to 10.

Example:

*SAV 1 will save all the present settings to user setting location 1.

To recall settings:

*RCL <user-setting>

To save default settings:

*SDS <user-setting>

Operation

Power Supply Operation

This will save factory default settings to a user setting location, replacing any setting that was previously saved there.

Example:

To save settings, set up the power supply with all required settings (we recommend that you do this right after recalling the factory default settings).

For example, you can set voltage, current, and all protection levels.

Then to save the settings to Location 1: issue the command `*SAV 1`

When you want to recall the settings, issue the command `*RCL 1`. If you want to recall them at the next power on, issue the command `OUTP:PON:REC USER1`

To change a stored setting, overwrite it with a new setting.

Set Up Power ON Defaults

You can change the power supply to power on with setpoints other than the factory defaults.

Use the command:

```
OUTP:PON:RECall [PRESet|USER <user-setting>|ASEQ  
<sequence-number>]
```

where the 4 options are:

- **PRESet:** The output is reset to the original factory levels at power on. (default)
- **USER <user-setting>:** The output is set to a custom setting recalled from memory. This assumes that at least one user setting has been set up and stored in memory. See [“User Settings \(Save and Recall\)” on page 55](#).
- **ASEQ <sequence-number>:** Recall a stored program. A RUN command must be issued to start running the program. This assumes that at least one program has been created and stored in memory. See [“Auto Sequencing” on page 60](#) for information about remotely programming and running auto sequence programs.

Example:

To power on user setting #1:

```
OUTP:PON:REC USER1
```

The user setting must be in the range of 1–10. See [“User Settings \(Save and Recall\)” on page 55](#) for an explanation of how to save user settings.

Power On Output State (XFR/XHR only) You may also change the output state whether the output is enabled or disabled at power on.

To change the power on at output state:

OUTP : PON : STAT [ON | OFF | 1 | 0]

Whether the unit powers on with output enabled is a function of both the state at power off and this setting.

Reset Resetting the unit puts certain features to a known state. These states are listed in [Table 3.2](#).

To reset the unit:

*RST or SYST:RES

Table 3.2 Features Affected by Reset (*RST) Command

Feature	Reset State (*RST)
Voltage setpoint	0.0V
Current setpoint	0.0A
Low voltage setpoint limit	0.0V
High voltage setpoint limit	101% of voltage rating
Low current setpoint limit	0.0A
High current setpoint limit	101% of current rating
Over voltage protection	Disabled (0.0V)
Under voltage protection	Disabled (0.0V) and not shutdown when tripped
Over current protection	Disabled (0.0A) and not shutdown when tripped
Under current protection	Disabled (0.0A) and not shutdown when tripped
Fold shutdown protection	None and delay 0.5s
AC off shutdown recovery	Auto recover
OTP shutdown recovery	Latched
Triggered voltage setpoint	Disabled (Default)
Triggered current setpoint	Disabled (Default)
Autosequence mode	Exit
Calibration mode	False
Output	Disabled

Operation

Power Supply Operation

Read Error Messages The error queue holds up to 50 error messages. Once each message has been read, it is cleared from the system.

To read from the error queue:

SYST:ERR?

This command returns an error code and message from the error queue. For example:

- -315, "Configuration memory test"
- -100, "Command error"
- 0, "No error"

See [Appendix C. "Error Messages"](#) for descriptions of the messages.

Clear Status Issue a Clear Status command to clear all error messages and status registers.

*CLS

or

STATus<channel>:CLEar

Configure Auxiliary Status Lines The Auxiliary (Aux) lines are 2 open collector outputs that can be used to monitor the status of the power supply. The auxiliary lines are referred to as AUX A and AUX B. The auxiliary status lines can be set up to report the following status conditions:

- **NONE**
- **ON:** Output On
- **OFF:** Output Off
- **OVOLtage:** Over-Voltage Condition
- **UVOLtage:** Under-Voltage Condition
- **OCURrent:** Over-Current Condition
- **UCURrent:** Under-Current Condition
- **FOLD:** Fold Protection Tripped
- **CC:** Constant Current Mode
- **CV:** Constant Voltage Mode
- **UNRegulated:** Output Unregulated
- **OTEMperature:** Over Temperature Protection Tripper
- **ACOFF:** AC Protection Tripped
- **SPProtection:** Sense Protection Tripper

To set up Auxiliary line A:

OUTP:AUXA:SOUR <aux-line-mnemonic>

To set up Auxiliary line B:

OUTP:AUXB:SOUR <aux-line-mnemonic>

The choices for <aux-line-mnemonic> are listed above.

To check the state of the line:

OUTP:AUXA:STAT?

OUTP:AUXB:STAT?

This command returns a 1 or 0. If it returns a 1, this means that the status selected as the auxiliary line mnemonic is true.

The XFR and XHR series power supplies use the polarity (POL) LED and fault (FTL) LED to indicate if the AUX A and AUX B status conditions are true.

Operation

Auto Sequencing

Auto Sequencing

Auto Sequencing allows users to program a sequence for automated operation. Up to 10 programmable sequences may be stored with up to 99 steps per sequence. Each step can be programmed to set the voltage setpoint, current setpoint, and OVP level. The steps are either programmed to run for a specific length of time or are programmed to pause and wait for a trigger input before continuing. The duration of each step may range from 10 ms to 99 hours.

Each sequence can be programmed to run a set number of repetitions or indefinitely. If the sequence contains steps that advance by a trigger event, a single trigger source can be selected to advance those steps.



CAUTION

Setpoint limits do not apply to auto sequence programmed setpoints.

Users can select and start a sequence, and while the sequence is running, pause or end it at any time. Users can also skip to the next step at any time.

Commands are also available to let users run, pause, resume, and restart an autosequence. A pause, or wait for trigger, causes the power supply to hold the output at the programmed level until the appropriate signal to continue is received.

Programming a Sequence

Select Sequence to Program

Using the following command, select a sequence that you want to work with. Sequences are identified with a number from 1 to 10.

```
PROGram:NAME <sequence_number>
```

<sequence_number> is a number between 1 and 10 that corresponds to the number of the sequence.

If <sequence_number> already exists, then that existing program is selected. If the program name does not exist, then the new name is selected, but no program is defined by this selection.

Editing the Sequence

To edit an existing step or to program new steps, use the following commands:

```
PROG:STEP<step_number>[:EDIT] [[ [<voltage>]  
, <current>], <OVP_level>], {<time>|TRIG}]
```

Any of the step parameters may be omitted, in which case the default parameters will be used. The default values for a step are 0 V, 0 A, 0 V, 10 ms.

Example:

```
PROG:STEP1 10,10  
PROG:STEP2 20,20,,20
```

will program step 1 to be 10V, 10A, OVP disabled (0V) and 10ms in duration and step 2 to be 20V, 20A, OVP disabled and 20 seconds in duration.

To insert a step between commands in an existing program, use this command:

```
PROG:STEP<step_number>:INS [[ [<voltage>]  
, <current>], <OVP_level>], {<time>|TRIG}]
```

The step number is where the inserted step is to be located. The existing step and all following steps at that location are moved down.

In both the edit and insert commands:

- <step_number> ranges from 1 to 99.
- <time> defines the duration of the step and may be given in the following formats:

hh:mm:ss.s hours/minutes/seconds

mm:ss.s minutes/seconds

<floating point number>H hours

<floating point number>M minutes

<floating point number>S seconds

<floating point number> seconds

Ranges from 10ms to 99 hours.

- TRIG may be entered instead of a step duration. In this case, the unit will hold the output levels at that step until a trigger signal is supplied.

Operation

Auto Sequencing

Setting Sequence Repetitions

Set the number of times a sequence will repeat before stopping execution.

```
PROG:REP {ONCE | <sequence_count> | FOR | INF}
```

- ONCE will run the sequence once and return it to its STOP condition.
- <sequence_count> ranges from 1 to 9999. It will run the sequence the number of times specified before putting it into the STOP condition.
- FORever and INFIinity cause the sequence to repeat forever. A query will return 9.9E37, representing INFIinity.

Selecting a Trigger Source

If any triggers are programmed into the sequence, select a trigger source:

```
PROG:TRIG:SOUR {BUS | MAN | EXT | IMM}
```

- BUS - trigger signal is IEEE 488.1 GET or *TRG
- MANual - trigger input is from the front panel TRIGGER key
- EXTERNAL - The external trigger line is selected as the source.
- IMMEDIATE - The source is the SCPI command "INIT:IMM"

Editing Step Parameters

Commands are provided to edit only one of voltage setpoint, current setpoint, OVP level, step duration, or end action.

- **Program step voltage:** PROG:STEP<step_number>:VOLT <voltage>
- **Program step current:** PROG:STEP<step_number>:CURR <current>
- **Program step OVP level:** PROG:STEP<step_number>:OVP <OVLevel>
- **Program step time (duration):** PROG:STEP<step_number>:DWEL {<time> | TRIG}

Deleting Steps

To delete any step from the sequence:

```
PROG:STEP<step_number>:DELEte
```

Subsequent steps are shift up.

Note The default value for a sequence's repeat time and trigger source is repeat once and trigger from key. See ["Setting Sequence Repetitions" on page 62](#) and ["Using Auto Sequencing" on page 63](#) for an explanation of how to edit these values.

Querying the number of steps

To query the number of steps that have been programmed:

```
PROG:STEP:COUNT?
```

Deleting a Sequence

Deleting Sequences

If you no longer need a sequence, select it with the `PROG:NAME` command and then delete it with the following:

```
PROG:DELEte
```

You can also use the following to delete all sequences:

```
PROG:DELEte:ALL
```

Using Auto Sequencing

Auto Sequence programs can be set to run as a Power ON default or recalled from memory.

Auto sequence programs can operate 3 different ways:

- They can run automatically through a series of steps, repeating those steps a pre-set number of times if necessary, and complete their operation without intervention from an operator.
- They can run automatically and be paused. If you need to stop the program temporarily, change its state to “**PAUSE**” to stop it, and then change the program’s state to “**RUN**” to resume the program’s operation when ready. The output remains on and voltage may be present at the output.
- They can run automatically programmed to wait for a trigger at certain points in the sequence. If you want the program to resume, you can supply a trigger signal to the rear panel Trigger input.

Select Sequence to Run

To run an auto sequence program, first select the program you wish to run:

```
PROG:NAME <sequence_number>
```

where `<sequence_number>` can range from 1 to 10.

Operation

Auto Sequencing

Operation

To run, stop or pause a sequence, use the following command:

```
PROG:STATe [RUN|PAUSE|STOP]
```

- Once the programmed sequence has been selected, you can start it by setting the state to RUN, by sending the command `PROG:STAT RUN`.
- At any time you can pause the sequence by sending `PROG:STAT PAUSE`. A paused sequence will cause the supply to hold the output levels at the setpoints programmed by the current step. To resume, set the state to RUN again.
- To end the sequence operation, send the command `PROG:STAT STOP`. Sending RUN will restart the auto sequence program from the first step.
- You can query the state of the selected auto sequence program with `PROG:STAT?`

Trigger

If the auto sequence was programmed to wait for a trigger, the power supply holds the output levels at the programmed setpoints until a trigger is received. It then advances to the next step. A trigger must come from the selected trigger source, which may be the GPIB bus, a SCPI command or the user lines.

Skipping a Step

To advance the sequence to the next step, send the command:

```
PROG:STEP:NEXT
```

Querying Operation

You can query the step number that is currently operating:

```
PROG:STEP:EXEC?
```

You can also query the number of times the sequence has executed:

```
PROG:REP:EXEC?
```

Exiting Auto Sequence Operation

To exit auto sequence operation and return to normal operation, send the command:

```
PROG:EXIT
```

Set V, I, and P Limits The voltage, current and power setpoints can be limited to less than the supply rating range to match the tolerance of connected equipment or any other criteria you may have.

Once the limits have been changed from the supply's default rated output, settings outside this range are no longer accepted.

Note Setpoint limits do not apply to the triggered outputs and auto sequence outputs.

To set the voltage limits:

SOUR:VOLT:LIM:HIGH <voltage>

SOUR:VOLT:LIM:LOW <voltage>

To set the current limits:

SOUR:CURR:LIM:HIGH <current>

SOUR:CURR:LIM:LOW <current>

If the high end of the range was set to 5 volts, the command, SOUR:VOLT 10 would return an error.

Triggered Setpoints **To set a triggered setpoint:**
SOUR:VOLT:TRIG <voltage>
SOUR:CURR:TRIG <current>

See [“Triggering Commands” on page 66](#) for more information.

Operation

Auto Sequencing

Triggering Commands

Triggers are event-driven signals that instruct power supplies to change their output. Triggering provides a method to control changes in the power supply's output and to program several power supplies to react at the same time. Triggering is useful in manufacturing processes where power requirements change as the machinery performs different operations.



CAUTION

Setpoint limits do not apply to triggered setpoints.

To program triggers:

1. Configure the desired output levels as a result of a trigger.

```
:VOLT:TRIG {<voltage>|MAX|MIN|DEF}  
:CURR:TRIG {<current>|MAX|MIN|DEF}
```

The user can choose to set both or just one of voltage or current triggered levels.

DEF (Default) means that when a trigger is received, no change will occur.

2. Specify a trigger signal source.

```
TRIG:SOURce {BUS|EXT|IMM|NONE} Where:
```

- BUS means the trigger source is the IEEE 488.1 GET or “*TRG”
- EXT means the source is the external trigger line. See [“User Lines” on page 40](#)
- IMM means the trigger source is the SCPI command INIT:IMM
- NONE means triggering is disabled.

Slew Rate The slew rate is calculated as a function of change in the output voltage and a given time interval. The maximum slew rate is 1% rated voltage/150us. The slew rate is saved upon power off and restored at power on. Output ON/OFF and shutdown are not affected by the programmable slew rate. These functions have a slew rate of 1%/20ms.

The range of output voltage is 5% - 0.1% of rated voltage.

The range of time interval is 1.5 s - 150 us.

The negative slew rate is limited by the discharge rate of the output capacitors.

During current share, slaves operate with their default slew rate. The master operates at its programmed slew rate. Hence a programmable slew rate for the system is achieved. However, this slew rate is limited by the speed of the control loop. The slaves will return to their programmed slew rate when they exit current share slave operation.

The slew rate error increases as the slew rate increases.

The SCPI commands for changing the voltage slew rate are:

:VOLT:SLEW:STEP {<slewrates-voltage> | MAX | MIN | DEF}

where voltage-step has the units V, mV, etc.

and the range is 0.1% to 5% of rated voltage for the power supply.

default step is 0.1% of rated output voltage.

query returns value in volts.

:VOLT:SLEW:INTerval {<slewrates-interval> | MAX | MIN | DEF}

where time interval has the units s, ms, or us

and the range is 150 us to 1.5s

default interval is 150us.

query returns value in volts.



CAUTION

Check both the voltage step and the interval to ensure you get the required slew rate.

Selecting **DEFAULT** for both settings will return the slew rate to the default value of 1% rated voltage per 150us.

The combination must not exceed 1%/150us. Though the software will attempt to achieve higher slew rates, it is limited to this value by hardware constraints. Manufacturer's recommendation is to keep the slew rate at or below the default value.

Operation

Auto Sequencing

Example:

Set a slew rate of 100V/10s for a 100V-60A power supply. This slew rate is 1V/0.1s, which is within the acceptable range.

Send the commands:

```
" :VOLT:SLEW:STEP 1", and
```

```
" :VOLT:SLEW:INT 100ms"
```

Using smaller steps will result in a smoother curve.

Identification Query

The identification query command returns a string that states the manufacturer, model, serial number, and firmware revision.

```
*IDN?
```

may return "Xantrex, XFR 10-120, 100000, 3.000/0/0/0000.

Option Identification Query

```
*OPT?
```

or

```
SYST<channel>:OPTion?
```

The option identification query returns a string listing any reportable options that are installed in the power supply. Reportable options are GPIB and CANbus, but may include others in the future. A zero will be returned if no options are installed.

Example:

*OPT? may return "GPIB, CANBUS" to indicate that both the GPIB and CANbus (Multichannel/Current Share) options are installed.

SCPI Version Query

```
SYST:VERS?
```

will return the SCPI version to which the unit complies (for example 1997-0).

Section 4. Status Registers

Overview

The Status Register structure is mandatory for SCPI and IEEE 488.2 compliance. The register bits are defined by the SCPI and IEEE 488.2 standards.

Each status register has a Condition, Event, and Enable register and transition filters. See [“Status Register Commands” on page 81](#) for commands to read or change their values.

Condition Register Transitions of the condition register are automatic and reflect the condition of the instrument at the moment. Reading a condition register has no effect on the contents.

Event Register The event register bits are set automatically to correspond with changes in the condition register. The rules are dependent on the positive and negative transition registers. Reading an event register clears it. The *CLS command clears all event registers.

Enable Register The enable register enables reporting of the event bits to the summary bit or the status byte. The contents of the enable register are unchanged by *CLS and *RST.

Transition Filters A positive transition filter allows an event to be reported when a condition changes from false to true. Setting both positive and negative filters to TRUE allows an event to be reported any time the condition changes. Clearing both filters disables event reporting.

The contents of transition filters are unchanged by *CLS and *RST.

The status registers may be divided into 4 categories, the operation status registers, the questionable status registers, the standard event status register and the status byte.

The default setting for all transition filters is to report only positive (FALSE to TRUE) transitions.

OPERation Status Register The operation status register is a 16-bit register which contains information about conditions which are part of the power supply's normal operation.

Status Registers

Overview

The Operation Status data structure has the operation status register and 5 sub-registers to represent regulation, shutdown, protection shutdown, remote control, and current sharing modes. Each of the sub-registers is summarized in a summary bit.

[Figure](#) represents the Operation Status data structure. The “+” represents the logical summation of bits in a register. [Table 4.1](#), [Table 4.2](#), [Table 4.3](#), [Table 4.5](#), and [Table 4.6](#) describe the meanings of each bit as well as the bit number and bit weight.

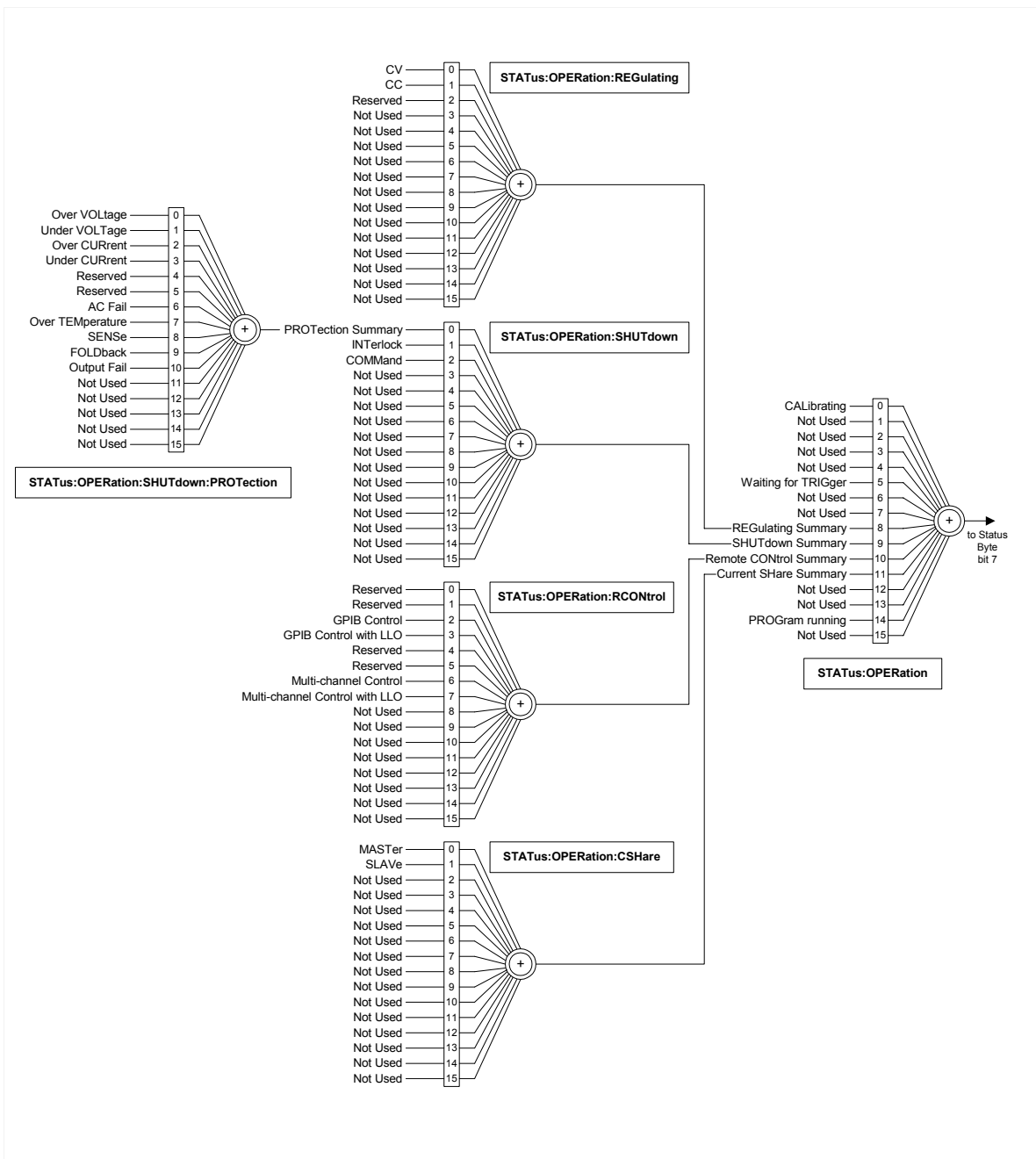

Figure 4.1 Operation Status Registers

Status Registers

Overview

Table 4.1 OPERation Status Register

Bit	Bit Weight	Bit Name	Description
0	1	CALibrating	Indicates that the supply is in CALibration Mode.
1	2	Reserved	Not implemented
2	4	Reserved	Not implemented
3	8	Reserved	Not implemented
4	16	Reserved	Not implemented
5	32	Waiting for TRIGger Summary	Indicates if the supply is waiting for a TRIGger.
6	64	Reserved	Not implemented
7	128	Reserved	Not implemented
8	256	REGulating Summary	Reflects the summary of the REGulating Sub-Register.
9	512	SHUTdown Summary	Reflects the summary of the SHUTdown Sub-Register.
10	1024	Remote CONTRol Summary	Reflects the summary of the Remote CONTRol Sub-Register.
11	2048	Current SHareSummary	Reflects the summary of the Current Share Sub-Register.
12	4096	Not Used	Not used
13	8192	Reserved	Not implemented
14	16384	PROGram Running	Indicates that an Automated Sequence is running.
15	32768	Not Used	Not used

REGulating Sub-Register

This describes the regulating mode. If none of these bits is active, the output unregulated (UNRegulated) bit is active in the questionable status register.

Table 4.2 REGulating Sub-Register

Bit	Bit Weight	Bit Name	Description
0	1	CV	The power supply is regulating in Constant Voltage mode.
1	2	CC	The power supply is regulating in Constant Current mode.

**SHUTdown
Sub-Register**

The Shutdown sub-register indicates the cause of the power supply shutdown. More than one bit may be active, and multiple actions will be required to enable the output. The protection shutdown sub-register indicates which protection mechanisms have caused the power supply to shutdown.

Table 4.3 SHUTdown Sub-Register

Bit	Bit Weight	Bit Name	Description
0	1	PROTECTio n Summary	The power supply is shut down by a power supply protection mechanism.
1	2	INTerlock	The power supply is shut down by INTerlock signal.
2	4	COMMand	The power supply is shut down by a command.

**Protection
SHUTdown
Sub-Register**

Table 4.4 Protection SHUTdown Sub-Register

Bit	Bit Weight	Bit Name	Description
0	1	Over VOLTage	Over voltage protection has tripped
1	2	Under VOLTage	Under voltage protection has tripped
2	4	Over CURrent	Over current protection has tripped
3	8	Under CURrent	Under current protection has tripped
4	16	Reserved	
5	32	Reserved	
6	64	AC Fail	AC Fail protection has tripped
7	128	Over Temperature	Over temperature protection has tripped
8	256	SENSe	Sense protection has tripped
9	512	FOLDback	Foldback protection has tripped
10	1024	Output Fail	The power supply is shutdown by a hardware circuit that monitors the output and compares it to the setpoint. Shutdown could indicate a bridge failure. A temporary condition may be caused by transients.

**Remote
CONTROL
Sub-Register**

This identifies which remote interface is controlling the unit. Only one bit is active at a time with the exception of analog control, where voltage or current alone, or both may be under remote control. Current share mode is considered to be under local control, even though the user cannot adjust the voltage setting from the front panel.

Status Registers

Overview

Table 4.5 Remote CONtrol Sub-Register

Bit	Bit Weight	Bit Name	Description
0	1	Reserved	
1	2	Reserved	
2	4	GPIB CONtrol	The power supply is under Remote CONtrol via the GPIB interface.
3	8	GPIB CONtrol with LLO	The power supply is under Remote Control via the GPIB interface, with local controls locked out.
4	16	Reserved	Reserved
5	32	Reserved	Reserved
6	64	Multi-chann el CONtrol	The power supply is under Remote CONtrol via the Multi-channel Programming interface.
7	128	Multi-chann el Control with LLO	The power supply is under Remote CONtrol via the Multi-channel Programming interface, with local controls locked out.

Current Share Sub-Register

This register shows the state of the current share configuration, which can be set through the SCPI command `SOURce:COMBine:CSHare:MODE`.

Table 4.6 Current SHare Sub-Register

Bit	Bit Weight	Bit Name	Description
0	1	MASTer	The power supply is configured to be a Current Share Master.
1	2	SLAVe	The power supply is configured to be a Current Share Slave.

QUESTionable Status Register

The Questionable Status Register is a 16-bit register that stores information about questionable events or status during power supply operation. That is, bits in these registers may indicate that the output of the supply is of undesirable or questionable quality.

The Questionable Status data structure consists of a questionable status register and sub-registers representing the status of the voltage and current, power and temperature.

[Figure 4.2](#) gives an overview of the Questionable Status data structure. The “+” represents the logical summation of bits in a register. [Table 4.7](#), [Table 4.8](#), and [Table 4.9](#) describe the meanings of each bit as well as the bit number and bit weight.

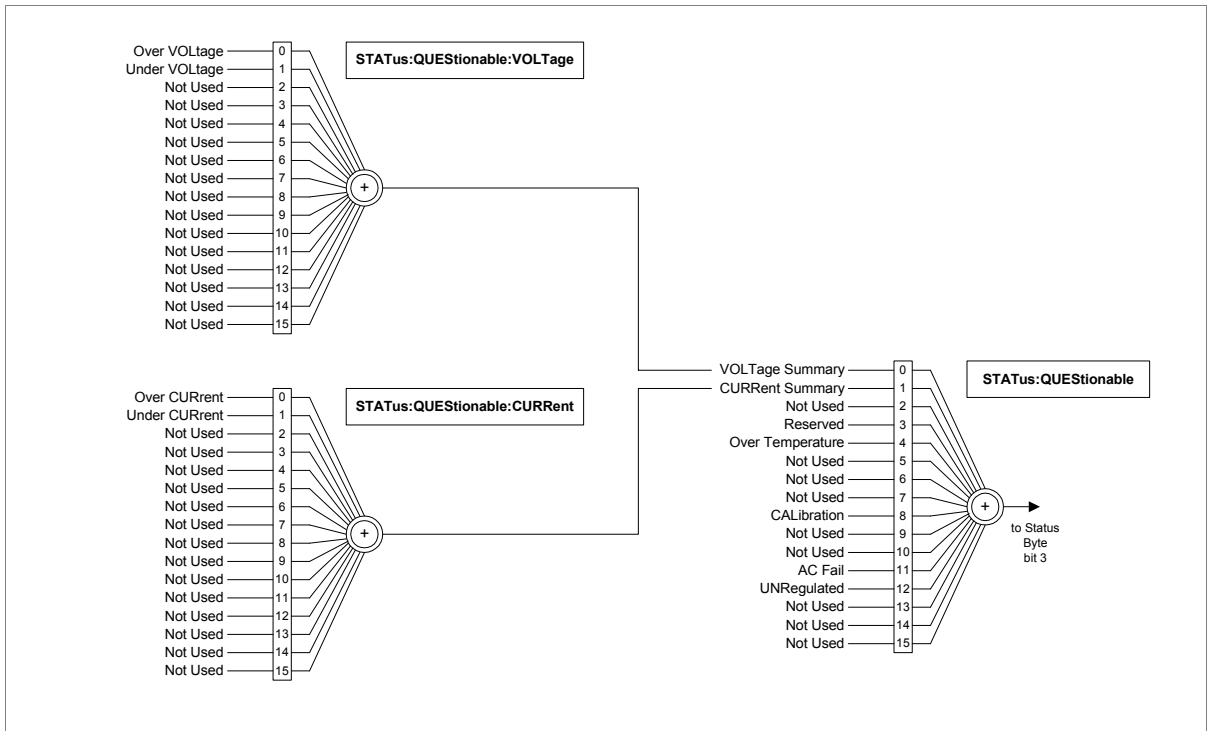

Figure 4.2 Questionable Status Registers

Status Registers

Overview

Table 4.7 QUEStionable Status Register

Bit	Bit Weight	Bit Name	Description
0	1	VOLTage Summary	Reflects a summary of the VOLTage Sub-Register.
1	2	CURRent Summary	Reflects a summary of the CURRent Sub-Register.
2	4	TIME	Not implemented
3	8	Reserved	
4	16	Over Temperature	Indicates the OTP circuit has tripped.
5	32	FREQuency Summary	Not implemented
6	64	PHASe Summary	Not implemented
7	128	MODulation Summary	Not implemented
8	256	CALibration	Indicates an error in the unit calibration.
9	512	Not Used	Not implemented
10	1024	Not Used	Not implemented
11	2048	AC Off	Indicates an AC Supply failure.
12	4096	UNRegulated	Indicates that the output is not regulated in either Constant Voltage mode, Constant Current mode or Constant Power mode. Reflects the inverse of the Operation Regulation Summary bit.
13	8192	INSTRument Summary	Not implemented
14	16384	Command Warning	Not implemented
15	32768	Not Used	Always zero

VOLTage Sub-Register

This shows whether the present voltage level is over or under the specified trip limit.

Table 4.8 VOLTage Sub-Register

Bit	Bit Weight	Bit Name	Description
0	1	Over VOLTage	Set if the supply's output voltage exceeds the over-voltage trip level, either user-specified variable trip limit, or the fixed trip limit.
1	2	Under VOLTage	Set if the supply's output voltage is less than the user-specified under-voltage trip level (variable trip limit) and the supply is in Operation state.

**CURRent
Sub-Register**

This shows whether the present current level is over or under the specified trip limit.

Table 4.9 CURRent Sub-Register

Bit	Bit Weight	Bit Name	Description
0	1	Over CURrent	Set if the supply's output current is greater than the user-specified over-current trip level (variable trip limit) and the supply is in Operation state.
1	2	Under CURrent	Set if the supply's output current is less than the user-specified under current trip level (variable trip limit) and the supply is in Operation state.

**Standard
Event Status
Register**

The standard event status register sets bits for specific events during power supply operation. All bits in the standard event status registers are set through the error event queue. The register is defined by 488.2 and is controlled using 488.2 common commands, *ESE, *ESE?, and *ESR?.

Figure 4.3 summarizes the standard Event Status Register

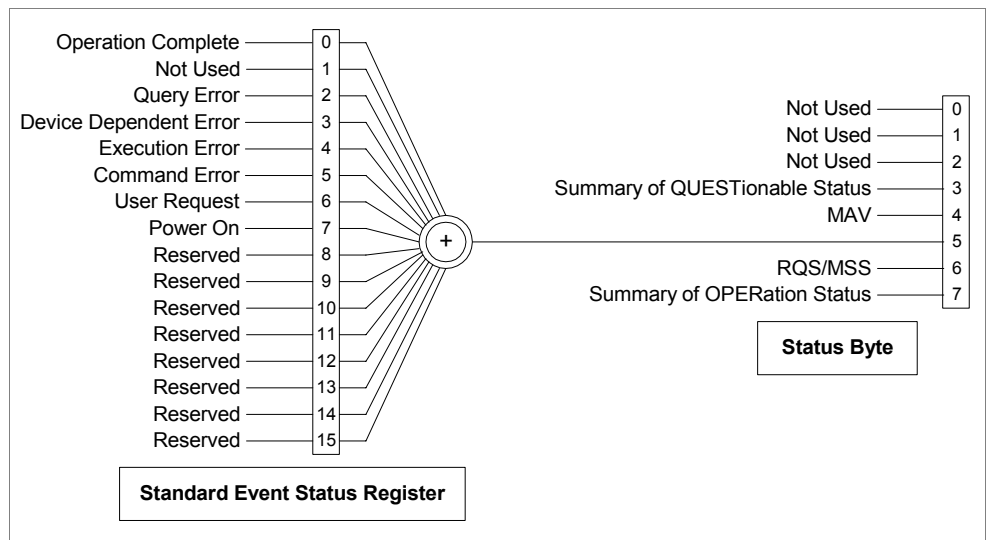

Figure 4.3 IEEE 488.2 Status Register and Status Byte

Status Registers

Overview

Table 4.10 Standard Event Status Register

Bit	Bit Weight	Bit Name	Description
0	1	Operation Complete (OPC)	Set if *OPC command has been received and all pending operations have been completed. The message, Event –800 Operation Complete, is loaded into the Error/Event Queue.
1	2	Request Control (RQC)	Not implemented. Always set to 0.
2	4	Query Error (QYE)	Set if an attempt is being made to read data from the output queue when no output is either present or pending. Suggests that data in the output queue has been lost. See “Query Error List” on page 121 for possible error codes.
3	8	Device Dependent Error (DDE)	Set if there is a device-specific error. See “Device-Specific Error List” on page 120 for possible error codes.
4	16	Execution Error (EXE)	Set if a program data element, following a header, was evaluated by the power supply as outside of its legal input range, or is otherwise inconsistent with the power supply’s capabilities. Suggests that a valid program message could not be properly executed due to some power supply condition. See “Execution Error List” on page 118 for possible error codes.
5	32	Command Error (CME)	Set if an IEEE488.2 syntax error has been detected by the parser, an unrecognized header was received, or a group Execute Trigger was entered into the input buffer inside an IEEE 488.2 program message. See “Command Error List” on page 118 for possible error codes.
6	64	User Request (URQ)	Set if the bit is unmasked and the instrument wishes to support a 488.2 user request event. An event occurs when the instrument detects the activation of a user request local control. The message, Event –600 User Request, is loaded into the Error/Event Queue.
7	128	Power ON (PON)	Not implemented
8–15		Reserved	Reserved for possible future use by IEEE. Bit values are reported as zero.

Status Byte The Status byte register contains the STB and RQS(MSS) messages as defined in 488.1. The user can read the status byte register using a 488.1 serial poll or the 488.2 *STB? common command. If the user sends a serial poll, bit 6 will respond with Request Service (RSQ). The value of the status byte is not altered by a serial poll.

The *STB? query causes the device to send the contents of the Status Byte Register and the Master Summary Status (MSS) summary message. The *STB? query does not alter the status byte, MSS, or RQS.

Table 4.11 Status Byte Summary Register

Bit	Bit Weight	Bit Name	Description
0	1	Reserved	
1	2	Reserved	
2	4	Error/Event Queue (ERR)	Set if any errors are present in the Error/Event queue.
3	8	Questionable Status Register (QSR)	Set if any bits are set in the Questionable Status Event register and the corresponding bit then the Questionable Status Enable register is TRUE.
4	16	Message Available (MAV)	MAV is TRUE if the power supply is ready to accept a request from the controller to output data. FALSE when the output queue is empty.
5	32	Standard Event Status Bit Summary (ESB)	A summary of the Standard Event Status Register. TRUE with a bit is set in the Standard Event Status register.
6	64	Request Service (RQS) Master Status Summary (MSS)	MSS indicates that the device has at least one reason for requesting service.
7	128	Operation Status Register (OSR)	TRUE if a bit is set in the Operation status register and the corresponding bit in the Operation Status Enable register is set.

Status Registers

Overview

Master Summary Status (MSS)

The Master Summary Status message indicates that the power supply has at least one reason for requesting service. Although the MSS message is sent in bit position 5 of the response to *STB?, it is not sent in response to a serial poll and not considered part of the Status Byte.

MSS is TRUE if:

- Status Byte bit 0 AND Service Request Enable Register bit 0, or
- Status Byte bit 1 AND Service Request Enable Register bit 1, or
- Status Byte bit 2 AND Service Request Enable Register bit 2, or
- Status Byte bit 3 AND Service Request Enable Register bit 3, or
- Status Byte bit 4 AND Service Request Enable Register bit 4, or
- Status Byte bit 5 AND Service Request Enable Register bit 5, or
- Status Byte bit 7 AND Service Request Enable Register bit 7.

Request Service (RQS)

RQS is TRUE if the Service Request Enable Register has a bit set and there is a corresponding bit within the Status Byte.

The SRQ line of the GPIB will be set. The SRQ annunciator will be lit.

Status Register Commands

In the following sections <status-enable> is a value from 0 to 32767 representing a 15-bit register mask.

SCPI Status Preset Status Commands

STATus [<channel>] : PRESet

Configures the status data structures to ensure that certain events are reported at a higher level through the status-reporting mechanism. These events are summarized in the mandatory structures, the Operation Status Register, and Questionable Status Register.

The PRESet command affects only the enable registers and the transition filter registers of the status data structures. PRESet does not clear any of the event registers or any item from the error/event queue. The *CLS command is used to clear all event registers and queues in the device status-reporting mechanism.

For the device-dependent status data structures, the PRESet command sets the enable register to all 1s and the transition filter register to report only positive transitions. For the SCPI mandatory status data structures, the PRESet command sets the transition filter registers to recognize only positive transitions and sets the enable register to 0s. The following will not be affected by this command: Service Request Enable Register, Parallel Poll Enable Register, the memory register associated with the *SAV command, the power supply address, Output Queue, and the power-on-status-clear flag setting.

Table 4.12 Preset Values of User Configurable Registers

Register	Filter/Enable	Preset Value
Operational	Enable Register	0s
	Positive Transition Filter	1s
	Negative Transition Filter	0s
Questionable	Enable Register	0s
	Positive Transition Filter	1s
	Negative Transition Filter	0s
All others	Enable Register	1s
	Positive Transition Filter	1s
	Negative Transition Filter	0s

Status Registers

Status Register Commands

IEEE 488.2 Clear Status Command

Status and Event Commands

Clears all Event Registers, including the Status Byte, the Standard Event Status and the Error Queue.

*CLS

or the multichannel equivalent:

STATus<channel>:CLEAr

Standard Event Status Enable Register

The Event Summary Enable command determines which bits in the Standard Event Status Register are summarized in the Event Summary Bit (ESB) of the Status Byte.

The Power-on Status Clear command determines if the Standard Event Status Enable Register is cleared at power-on.

E.g.

Sending "*ESE 16" sets bit 4 of the Standard Event Status Enable Register. This will cause the Event Summary bit (ESB) in the Status Byte to be set whenever the Execution Error bit (bit 4) in the Standard Event Status Register gets set.

Command: *ESE <status-enable>, *ESE?

or the multichannel equivalent:

STATus<channel>:STANdard:ENABle <status-enable>

STATus<channel>:STANdard:ENABle?

Standard Event Status Register

The Standard Event Status Register query allows the user to determine the current contents of the Standard Event Status Register. (See [“Standard Event Status Register” on page 77.](#)) Reading this register clears it.

Command: *ESR?

SCPI equivalent for multichannel use:

STATus<channel>:STANdard[:EVENT]?

Service Request Enable Register

The Service Request Enable Register allows the user to select the reasons for the power supply to issue a service request. The Service Request Enable Register allows the user to select which summary messages in the Status Byte Register may cause service requests.

To clear the Service Request Enable Register send "*SRE 0." The Power-on Status Clear command also determines if the Service Request Enable Register is cleared at power-on. A cleared register does not allow status information to generate a service request.

E.g.

Sending "*SRE 8" sets bit 3 of the Service Request Enable Register. This will cause the Summary bit of the Questionable Status register (bit 3) in the Status Byte to generate a service request message whenever it gets set.

*SRE <status-enable>, *SRE?

or the multichannel equivalent:

STATus<channel>:SREQuest:ENABLE <status-enable>
STATus<channel>:SREQuest:ENABLE?

Parallel Poll Enable Register

Each of the 16 bits in the Parallel Poll Enable register correspond to bits in the Status Byte. Each bit in the Parallel Poll Enable register is ANDed with its corresponding bit in the Status Byte and the resulting bits are ORed together to generate ist. Therefore using the parallel poll enable register allows any single bit or combination of bits to control the ist message.

The Power-on Status Clear command determines if the Parallel Poll Enable Register is cleared at power-on.

E.g.

Sending "*PRE 8" sets bit 3 of the Parallel Poll Enable Register. This will cause the Summary bit of the Questionable Status register (bit 3) in the Status Byte to generate a TRUE ist message whenever it gets set.

Command: *PRE <status-enable>, *PRE?

Status Byte

The status byte query will return the contents of the status byte register and the MSS (Master Summary Status) message. The response is in the format of a weighted decimal value representing the status byte register and the MSS message (bit 6). Thus, the response to *STB? is identical to the response to a serial poll except that the MSS message appears in bit 5 in place of the RQS message. (See "[Status Byte](#)" on page 79 for details.)

*STB?

Status Registers

Status Register Commands

or the multichannel equivalent
STATus<channel>:SBYTe[:EVENT]?

Power-on Status Clear

The Power-On Status Clear command controls the automatic power-on clearing of the Service Request Enable Register, the Standard Event Status Enable Register, the Parallel Poll Enable Register and the Error/Event Queue.

*PSC {0|1}, *PSC?

or the multichannel equivalent
SYSTem<channel>:POSClear {ON|OFF|0|1}
SYSTem<channel>:POSClear?

Individual Status Query

The individual status query allows the programmer to read the state of the IEEE 488.1 ist (individual status) message without performing a parallel poll. The query returns a "1" or "0."

The ist message is formed by ANDing the bits in the Parallel Poll Enable Register (*PRE) with the Status Byte and then ORing the result. In other words, the ist is TRUE if any of bits of the Parallel Poll Enable Register AND'ed with the Status Byte are TRUE.

*IST?

Operation Complete

The Operation Complete command causes the power supply to generate the operation complete message in the Standard Event Status Register when all pending operations have been finished.

*OPC, *OPC?

Wait-to-Continue Command

The Wait-to-Continue command prevents the power supply from executing any further commands or queries until the no-operation-pending flag is TRUE.

*WAI

Operation Status Register Commands

Query Operation Status Register Condition
STAT [<channel>] :OPER:COND?

Query Operation Status Register Event
STAT [<channel>] :OPER[:EVEN] ?

Enable Operation Status Register
STAT [<channel>] :OPER:ENAB <status-enable>

Set Operation Status Positive Transition Filter
STAT [<channel>] :OPER:PTR <status-enable>

Set Operation Status Negative Transition Filter
STAT [<channel>] :OPER:NTR <status-enable>

Regulating Sub-Register Commands

Query Regulating Condition
STAT [<channel>] :OPER:REG:COND?

Query Regulating Event
STAT [<channel>] :OPER:REG[:EVEN] ?

Enable Regulating Sub-Register
STAT [<channel>] :OPER:REG:ENAB <status-enable>

Set Regulating Positive Transition Filter
STAT [<channel>] :OPER:REG:PTR <status-enable>

Set Regulating Negative Transition Filter
STAT [<channel>] :OPER:REG:NTR <status-enable>

Shutdown Sub-Register Commands

Query Shutdown Condition
STAT [<channel>] :OPER:SHUT:COND?

Query Shutdown Event

Status Registers

Status Register Commands

STAT [<channel>] :OPER:SHUT [:EVEN] ?

Enable Shutdown Sub-Register

STAT [<channel>] :OPER:SHUT:ENAB <status-enable>

Set Shutdown Positive Transition Filter

STAT [<channel>] :OPER:SHUT:PTR <status-enable>

Set Shutdown Negative Transition Filter

STAT [<channel>] :OPER:SHUT:NTR <status-enable>

Protection Shutdown Sub-Register Commands

Query Protection Shutdown Condition

STAT [<channel>] :OPER:SHUT:PROT:COND?

Query Protection Shutdown Event

STAT [<channel>] :OPER:SHUT:PROT [:EVEN] ?

Enable Protection Shutdown Sub-Register

STAT [<channel>] :OPER:SHUT:PROT:ENAB <status-enable>

Set Protection Shutdown Positive Transition Filter

STAT [<channel>] :OPER:SHUT:PROT:PTR <status-enable>

Set Protection Shutdown Negative Transition Filter

STAT [<channel>] :OPER:SHUT:PROT:NTR <status-enable>

Remote Control Sub-Register Commands

Query Remote Control Condition

STAT [<channel>] :OPER:RCON:COND?

Query Remote Control Event

STAT [<channel>] :OPER:RCON [:EVEN] ?

Enable Remote Control Sub-Register

STAT [<channel>] :OPER:RCON:ENAB <status-enable>

Set Remote Control Positive Transition Filter

STAT [<channel>] :OPER:RCON:PTR <status-enable>

Set Remote Control Negative Transition Filter

STAT [<channel>] :OPER:RCON:NTR <status-enable>

**Current
Share
Sub-Register
Commands**

Query Current Share Register Condition

STAT [<channel>] :OPER:CSH:COND?

Query Current Share Register Event

STAT [<channel>] :OPER:CSH[:EVEN]?

Enable Current Share Sub-Register

STAT [<channel>] :OPER:CSH:ENAB <status-enable>

Set Current Share Positive Transition Filter

STAT [<channel>] :OPER:CSH:PTR <status-enable>

Set Remote Control Negative Transition Filter

STAT [<channel>] :OPER:CSH:NTR <status-enable>

**Questionable
Status
Register
Commands**

Query Questionable Status Register Condition

STAT [<channel>] :QUES:COND?

Query Questionable Status Register Event

STAT [<channel>] :QUES[:EVEN]?

Enable Questionable Status Register

STAT [<channel>] :QUES:ENAB <status-enable>

Set Questionable Status Positive Transition Filter

STAT [<channel>] :QUES:PTR <status-enable>

Set Questionable Status Negative Transition Filter

STAT [<channel>] :QUES:NTR <status-enable>

Status Registers

Status Register Commands

Voltage Sub-Register Commands

Query Voltage Sub-Register Condition

STAT [<channel>] :QUES:VOLT:COND?

Query Voltage Sub-Register Event

STAT [<channel>] :QUES:VOLT[:EVEN]?

Enable Voltage Sub-Register

STAT [<channel>] :QUES:VOLT:ENAB <status-enable>

Set Voltage Positive Transition Filter

STAT [<channel>] :QUES:VOLT:PTR <status-enable>

Set Voltage Negative Transition Filter

STAT [<channel>] :QUES:VOLT:NTR <status-enable>

Current Sub-Register Commands

Query Current Sub-Register Condition

STAT [<channel>] :QUES:CURR:COND?

Query Current Sub-Register Event

STAT [<channel>] :QUES:CURR[:EVEN]?

Enable Current Sub-Register

STAT [<channel>] :QUES:CURR:ENAB <status-enable>

Set Current Positive Transition Filter

STAT [<channel>] :QUES:CURR:PTR <status-enable>

Set Current Negative Transition Filter

STAT [<channel>] :QUES:CURR:NTR <status-enable>

Section 5. Current Sharing

Overview



CAUTION

Always exercise caution when using the current sharing feature. If a unit is set to Master or Slave, it will be locked out of local operation. Current sharing units will have their outputs disabled if one power supply enters shutdown.

The current sharing function allows power supplies to current share between units connected in parallel. Current sharing can use a maximum of 5 supplies. All power supplies must be the same model. Every unit must have a unique address. See [“Configure for Multichannel Operation” on page 35.](#)

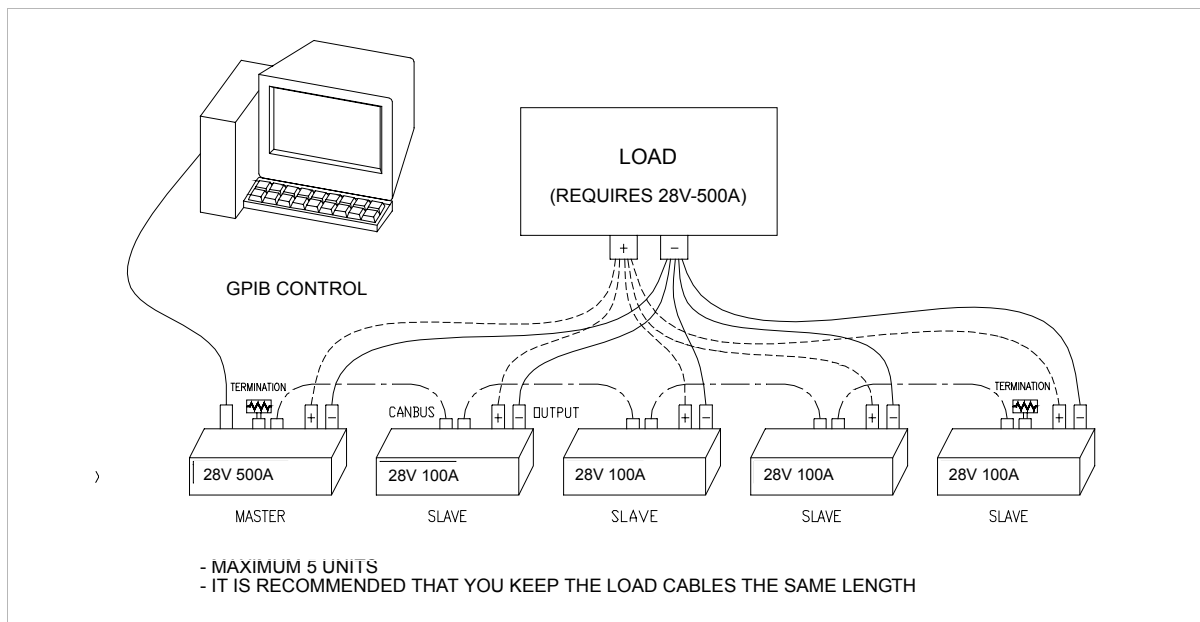

Figure 5.1 Example of Current Share Operation

Current Sharing

Overview

Theory of Operation Power supplies may be connected in parallel to supply a large current to a load. Typically, because of differences in the load connections, each power supply may provide different amounts of current to the load.

When multiple power supplies are configured for current sharing, the master supply will make minute changes to the slave's voltage and current to equalize the current draw from each. The slaves will track the master's voltage, current, output and output on/off setting. Protection limits are controlled and monitored on the master unit.

Configure Current Share The current sharing modes available are:

- **No sharing**
- **Master:** sets up the unit as the master controller.
- **Slave:** sets up the unit as the controlled slave.

Select whether the unit will operate as a master or slave unit:

```
SOURce:COMBine:CSHare:MODE [MASTer|SLAVE|OFF]
```

To query the total output current of all current sharing units, use the SCPI command:

```
MEAS:CURR? SUM
```

The current share subregister (CSHare) will show whether the master or slave is operating.

```
STAT:OPER:CSH:COND?
```

See Table 4.9, "CURRent Sub-Register," on page 77 for a description of the bits in this register.

Setup Current Sharing Network

To set up multiple supplies for current share operation, follow these steps:

1. Configure each supply with a unique multichannel address. (See ["Configure for Multichannel Operation" on page 35.](#))
Configure one supply to operate as the master. Configure others to operate as slaves.
2. Power down the units. Connect the CAN ports of all paralleled units as you would for multichannel operation
3. Make load connections. It is recommended to keep load cables the same length if possible. See [Figure 5.1.](#)
4. Power up the master, then all slaves.
5. Set the voltage on the master, then enable the output.

Operation

Once a current sharing network is setup, you may adjust the voltage setpoint on the master. The master will automatically adjust the setpoints of the slave units to equalize the current output of all units. You may also disable or enable the output of the master, automatically disabling or enabling the output of all slaves.

You must use GPIB control to operate the master.

Slaves will be operating under remote control from the master and in local lockout. Hence, they will only respond to remote queries. XFR or XHR power supplies will still respond to the STANDBY key on the front panel.

Power supplies may not enter calibration mode while current sharing, or enter current share operation while in calibration mode.

Errors The slave will queue and error if it does not detect a master on the network. Check the cable and the master configuration.

A master or slave will be disabled from current sharing (set to "No share") if:

- there is more than one master connected to the CANbus, (Error +1811)
- there are more than 4 slaves, (Error +1822), or
- the model does not match that of the master, (Error +1822).

In each of these cases, the current share mode will be set to "No share".

If a unit becomes disconnected due to a failure in communications, the master will queue error +1812, "Current Share Slave Lost" and the slave will queue error +1821, "Current Share Master Lost." The slave's output will be disabled, and the slave annunciator will flash.

Current Sharing

Operation

Appendix A. GPIB

Overview

This power supply can be programmed from a remote terminal using a General Purpose Interface Bus (GPIB) interface. Communications over the GPIB interface meet IEEE 488.2 standards and are SCPI compliant.

Codes and Standards

The GPIB interface of the this Programmable DC Power Supply has been implemented according to IEEE standard 488.1-1987, "IEEE Standard Digital Interface for Programmable Instrumentation."

The communications protocol complies with IEEE 488.2-1992.

Message Terminators

The GPIB End of message (EOM) terminators can be the END message (EOI), the ASCII code for line feed (LF) or both.

The power supply terminates responses with line feed (LF).

Address Range

Primary The power supply will respond to any GPIB address in the range 1 to 30.

Secondary The power supply does not support secondary addressing.

Service Request and Polling

The power supply's serial poll responses and SRQ generation use an IEEE 488.2 reporting structure. See ["The Status Register structure is mandatory for SCPI and IEEE 488.2 compliance. The register bits are defined by the SCPI and IEEE 488.2 standards."](#) on page 69.

The Request Service bit (bit 6) in the Status Byte will generate a service request (SRQ) on the GPIB.

The power supply can be set up to generate a service request (SRQ) at power-on. Use the command:

```
SYSTem:COMMunicate:GPIB:PONSrq [ON|OFF|1|0]
```

Protocol Specifications

Multiline Control Functions IEEE 488.2 (Section 5) requires specific Device Interface Functions.

Table A.1Multiline Control Functions

Function	Mnemonic	Description	Functions Subset
Source Handshake	SH1	Complete capability	SIDS, SGNS, SDYS, STRS, SWNS, SIWS
Acceptor Handshake	AH1	Complete capability	AIDS, ANRS, ACRS, ACDS, AWNS
Talker	T6	Includes serial poll	TIDS, TADS, TACS, SPAS, SPIS, SPMS, TPIS, TPAS
Listener	L4		LIDS, LADS, LACS, LPIS, LPAS

Interface Functions IEEE 488.1 (Section 2).

Table A.2Interface Functions

Function	Mnemonic	Description	Functions Subset
Device Clear	DC1	Complete capability	DCIS, DCAS
Device Trigger	DT1	Complete capability	DTIS, DTAS
Drivers	E2	Tri state drivers where selectable	
Parallel Poll	PP1	Parallel Poll	
Remote/Local	RL1	Complete capability	LOCS, LWLS, REMS, RWLS
Service Request	SR1	Complete capability	NPRS, SQRS, APRS
Controller	C0	Device does not act as a controller	

Electrical Specifications

Driver Requirements IEEE 488.2 (Section 3.3).

Table A.3 Driver Types for Interface Lines

Signal Line	Driver	Signal Line	Driver
DIO1	Tri State	EOI	Tri State
DIO2	Tri State	DAV	Tri State
DIO3	Tri State	NRFD	Open Collector (mandatory)
DIO4	Tri State	NDAC	Open Collector (mandatory)
DIO5	Tri State	REN	Tri State
DIO6	Tri State	IFC	Tri State
DIO7	Tri State	SRQ	Open Collector (mandatory)
DIO8	Tri State	ATN	Tri State

Driver Specifications for 1 megabyte/second:

- Low State: Output voltage $< +0.5V$ at $+48mA$ sink current
- High State: Output Voltage (3 state) $\geq +2.4V$ at $-5.2mA$

The Output Voltage (open collector) is dependent on the composite Device Load Requirements. The Voltage values are measured at the device connector between the signal line and the logic ground.

Mechanical Specifications

Mechanical Specifications comply with IEEE 488.1 standards.

See Appendix E for details.

Performance Specifications

The power supply responds within 2 ms of receiving a command over the GPIB interface.

GPIB
Performance Specifications

Appendix B. SCPI Command Reference

Overview

This appendix provides a summary of the Standard Commands for Programmable Instruments (SCPI) that are supported by the this Programmable Interface Card.

Codes and Standards

This power supply conforms to the following international standards:

- IEEE Std 488.2-1992 “IEEE Standard Codes, Formats, Protocols, and Common Commands For Use With IEEE Std 488.1-1987”
- IEEE Std 488.1-1987 “IEEE Standard Digital Interface for Programmable Instrumentation”
- Standard Commands for Programmable Instruments (SCPI) Version 1997.0

IEEE 488.2 Requirements GPIB control implements all IEEE 488.2 requirements. See [Appendix A. “GPIB”](#) for details.

SCPI Requirements The power supply implements the following in order to meet SCPI requirements:

- SCPI mandated commands
- Questionable Status Register (QSR), Condition, Event, Enable
- Operation Status Register (OSR), Condition, Event, Enable
- Status Byte Register (SBR)
- Standard Event Status Register (SESR)

IEEE-488.2/SCPI Syntax and Style

Parameters Units of Measure and Multipliers

The default units of measure include:

- V (Volt – voltage)
- A (Ampere – current)
- W (Watt – power)
- S (seconds – time)

The supported optional multipliers include:

- m (milli)
- k (kilo)

Note The SI standard for these multipliers is specifically lowercase, while the IEEE standard specifies uppercase. Both combinations are supported.

Understanding SCPI Commands

SCPI Command Hierarchy SCPI is an ASCII-based command language designed for use in test and measurement equipment. The command structure is organized around common roots, or nodes, which are the building blocks of SCPI subsystems. An example of a common root is CALibration, and some of the commands that reside in the CALibration subsystem are shown below.

CALibration

```
:CURRent
  [:DATA] <numeric value>
  :LEVel {MIN|MAX}
[:SECure]
  :CODE <new code>
  :STATe {OFF|ON}, <code>
  :STATe?
```

CALibration is the root keyword of the command. CURRent and SECure are second-level keywords, and DATA, LEVel, CODE, and STATe, are third-level keywords. A colon (:) is used to separate a command keyword from a lower-level keyword.

Using SCPI Commands This manual may show SCPI commands in the either long or short format. An example of the long format is:

```
CALibration:CURRent:LEVel {<current>|MIN|MAX}
```

The command is expressed as a mixture of upper- and lowercase letters. The uppercase letters indicate how the command can be abbreviated to its short form:

```
CAL:CURR:LEV {<current>|MIN|MAX}
```

SCPI commands can be sent in long or short forms. The short form is typically better for data entry. The long form is usually better for readability.

Command strings are not case sensitive: CURR, Curr, and curr are all acceptable abbreviations for CURRent. As for the long form, CURRENT, Current, and current are all acceptable.

The command strings include punctuation. While some punctuation is sent with the string, other markings are used to identify different elements of the command syntax and are not sent with the string.

SCPI Command Reference

Understanding SCPI Commands

The following punctuation is sent with the command string:

- **Colons (:)** separate command keywords from lower-level keywords. For example, `CAL : CURR : STAT`.
- **Blank spaces** separate command keywords from parameter values. For example, `CURR 0 . 1`.
- **Commas** separate parameters from each other when more than one parameter is sent in the same string. For example, `CAL : STAT OFF , " 1234 . "`
- **Semicolons (;)** separate multiple commands from the same subsystem. This allows for greater efficiency. For example:

```
CAL : CURR : LEV MIN ; VOLT : LEV MIN
```

is the same as typing:

```
CAL : CURR : LEV MIN
```

```
CAL : VOLT : LEV MIN
```

- **Colons and semicolons** can be used together to link commands from different subsystems. For example:

```
CAL : CURR : LEV MIN ; : MEAS : CURR ?
```

The following punctuation is not sent with the command string:

- **Braces ({ })** identify a selection of choices. Choose one of the enclosed values.
- **Vertical bars, or pipes, (|)** separate the choices found within the braces.
- **Angle brackets (< >)** identify where specific values must be entered for a parameter. For example, in the example at the top of the page, the parameter `<current>` appears in the command string. To set the current setpoint to 0.1A, the syntax is `CAL : CURR : LEV 0 . 1`.
- **Square brackets ([])** identify optional parameters or keywords. If an optional parameter is not sent with the command string, a default parameter will be used.

Using Minimum and Maximum

In the following example, Minimum and Maximum are offered as alternative choices to declaring a specific parameter value.

```
CAL : CURR : LEV { <current> | MIN | MAX }
```

The string `CAL : CURR : LEV MIN` sets the current calibration level to the minimum model value.

Using Queries

A question mark lets you query the present value for most parameters. For example, to query the current calibration state use:

```
CAL:SEC:STAT?
```

Most commands that include a parameter can be queried to determine the present setting.

You can also use the following to query minimum and maximum allowed values for most parameters:

```
:VOLT? MIN  
:VOLT? MAX
```

Note If you send 2 queries, it is best to read and respond to the first response before trying to read the second. Otherwise, you may receive an incomplete first response followed by a complete second response. To avoid this, you can either wait for and read the first response before sending the second query, or send a device clear message before sending the second query.

Terminating Characters

Every command string must end with a terminating <new line> character. An IEEE-488 EOI (end-or-identify) can be used instead of a <new line> character. It is also acceptable to use a <carriage return> followed by a <new line>. Terminating a command string always resets the SCPI command path to the root level.

Common Commands

The IEEE-488.2 standard includes a set of common commands for functions such as reset and self-test. These common commands always start with an asterisk (*) and may have one or more parameters. The command is always separated from the parameter by a blank space. Multiple commands sent in the same string are separated by a semi-colon (;). The following is an example of how 3 common commands can be sent together in the same string:

```
*OPC; *PSC Off; *TRG
```

Parameter Types Several different data types are defined for use in program messages and response messages.

Boolean Parameters

Boolean parameters are single binary conditions such as 1 and 0, or ON and OFF. The following is an example of a command that uses Boolean parameters:

```
SYST:COMM:GPIB:PONS {ON|OFF|1|0}
```

Discrete Parameters

Discrete parameters are used when program settings have a limited number of values. If you query a discrete parameter, the response will always be in the short form with all uppercase letters. The following is an example of a command that uses discrete parameters:

```
TRIG:SOUR {BUS|EXT|IMM|NONE}
```

Numeric Parameters

Numeric parameters may include decimal points, +/- signs, and scientific notation. Values such as MINimum and MAXimum are sometimes accepted as substitutes for numbers. When DEFault is provided as a parameter, the machine selects the default value automatically. You may also use unit suffixes such as V, A, or W where appropriate. In cases where specific numeric values are accepted, the power unit will round the input parameters. The following is an example of a command that uses numeric parameters:

```
VOLT:PROT {<voltage>|MAX|MIN}
```

String Parameters

String parameters are used when a series of ASCII characters is required. Strings must be enclosed within single or double quotations. The beginning and ending quotation marks must be matching. The following is an example of a command that uses string parameters:

```
CAL:STAT ON, "0000"
```

SCPI Command Summary

The SCPI commands supported by the this Programmable Power Supply are described in the tables in the remainder of this section. These tables use the following column headings:

- **Function** The commonly used name for the function
- **SCPI Command** The full command in long form
- **Description** Explains what the command does or what is affected by it
- **Query?** Indicates whether the unit supports a query version of the listed command

Notations Used in the Tables

The following abbreviations are used in the command listings:

- **N/A** Not applicable. (The command has no associated setpoint value.)

Table B.1 IEEE 488.2 Commands

Function	SCPI Command	Description	Query
Clear Status	*CLS [:]STATUS [<channel>]:CLEAR	Clears the status data structures.	N/A
Standard Event Status Enable Query	*ESE? [:]STATUS [<channel>]:STANDARD:ENABLE	Query the Standard Event Status Enable register settings.	N/A
Standard Event Status Enable	*ESE [:]STATUS [<channel>]:STANDARD:ENABLE <ESE-word>	Set the Standard Event Status Enable Register bits.	N/A
Standard Event Status Register Query	*ESR? [:]STATUS [<channel>]:STANDARD[:EVENT]?	Query Standard Event Status Register.	N/A
Identification Query	*IDN? [:]SYSTEM [<channel>]:IDENTIFY?	Query identification string. (Manufacturer's information.)	N/A
Individual Status Query	*IST?	Reads the current state of the IEEE 488.1 defined "ist" local message in the device	N/A
Operation Complete Command	*OPC	Causes the device to generate the operation complete message in the Standard Event Status register when all pending detected device operations have finished	N/A
Query Operation Complete Command	*OPC?	Place and ASCII character "1" into the output queue when all pending operations have been finished. See IEEE 488.2-1992 section 12.5.3.	N/A
Option Identification Query	*OPT? [:]SYSTEM [<channel>]:OPTION?	Identify reportable device options	N/A
Parallel Poll Enable Register Query	*PRE?	Query the Parallel Poll Enable Register setting	N/A
Parallel Poll Enable Register Command	*PRE <status-enable>	Sets the Parallel Poll Enable Register bits. See IEEE 488.2 section 11.6 for details.	N/A
Recall	*RCL [:]SYSTEM [<channel>]:RECALL <setting_location>	Restores the settings of unit from values stored in memory.	N/A
Reset	*RST [:]SYSTEM [<channel>]:RESET	Performs a device reset. Set the power supply to a known state that is independent of the use history of the device.	N/A
Save User Settings	*SAV [:]SYSTEM [<channel>]:SAVE[USER] <setting_location>	Stores the current setting of the device in local memory. Scope is same as *RST	N/A
Save Default Settings	*SPDS [:]SYSTEM [<channel>]:SAVE:DEFAULT <setting_location>	Save the factory default settings.	N/A
Query Service Request Enable	*SRE? [:]STATUS [<channel>]:SREQUEST:ENABLE?	Query the Service Request Enable Register bits.	N/A
Service Request Enable	*SRE [:]STATUS [<channel>]:SREQUEST:ENABLE <status-enable>	Set the Service Request Enable Register bits.	N/A
Read Status Byte	*STB? [:]STATUS [<channel>]:SBYTE[:EVENT]?	Read the status byte and Master Summary Status bit.	N/A

Trigger	*TRG [:]SYSTEM [<channel>] :TEST?	Trigger commands. Analogous to the IEEE 488.1 defined Group Execute Trigger interface message. See IEEE 488.2 section 6.1.4.2.5	N/A
Self-Test Query	*TST? [:]SYSTEM [<channel>] :TEST?	Internal self-test and responds indicating whether or not the device completed the self-test without any detected errors.	N/A
Wait To Continue	*WAIT [:]SYSTEM [<channel>] :WAIT	Prevents the device from executing any further commands or queries until the no-operation-pending flag is TRUE. ('OPC?')	N/A

Table B.2Readback Commands

Function	SCPI Command	Description	Query
Read Output Current	[:]MEASure [<channel>] [:SCALar] :CURRENT [:DC]?	Read output current	N/A
Read Output Voltage	[:]MEASure [<channel>] [:SCALar] [:VOLtage] [:DC]?	Read output voltage	N/A

Table B.3 Commands for Output Control

Function	SCPI Command	Description	Query
Set (immediate) Current Setpoint	[[:]SOURCE] [<channel>]:CURRENT[:LEVEL] [:IMMEDIATE] [:A MPLitude] {<current> MAXIMUM MINIMUM}	Change current setpoint	Yes
Set Triggered Current Setpoint	[[:]SOURCE] [<channel>]:CURRENT[:LEVEL]:TRIGGERED[:AMP Litude] {<current> MAXIMUM MINIMUM DEFAULT}	Change triggered current setpoint	Yes
Set (immediate) Voltage Setpoint	[[:]SOURCE] [<channel>]:VOLTAGE[:LEVEL] [:IMMEDIATE] [:A MPLitude] {<voltage> MAXIMUM MINIMUM}	Change voltage setpoint	Yes
Set Triggered Voltage Setpoint	[[:]SOURCE] [<channel>]:VOLTAGE[:LEVEL]:TRIGGERED[:AMP Litude] {<voltage> MAXIMUM MINIMUM DEFAULT}	Change triggered voltage setpoint	Yes
Set Voltage Slew Rate Voltage	[[:]SOURCE] [<channel>]:VOLTAGE:SLEW:STEP:<slewratelimit> {<rate> MAXIMUM MINIMUM DEFAULT}	Sets the voltage slew rate voltage change for the programmed time interval	Yes
Set Voltage Slew Rate Interval	[[:]SOURCE] [<channel>]:VOLTAGE:SLEW:INTERVAL {<slewratelimit> MAXIMUM MINIMUM DEFAULT}	Sets the voltage slew rate time interval for the programmed voltage change	Yes
Set Over Current Protection Level	[[:]SOURCE] [<channel>]:CURRENT:PROTECTION[:OVER] [:LEVEL] {<current> MAXIMUM MINIMUM}	Set the over current protection level	Yes
Set Over Current Protection Shutdown State	[[:]SOURCE] [<channel>]:CURRENT:PROTECTION[:OVER]:STATE {<on-off-state>}	Select over current protection to shutdown(ON) or set alarm (OFF)	Yes
Query Over Current Protection Tripped	[[:]SOURCE] [<channel>]:CURRENT:PROTECTION[:OVER]:TRIPPED?	Query if over current protection mechanism has tripped	N/A
Set Under Current Protection Level	[[:]SOURCE] [<channel>]:CURRENT:PROTECTION:UNDER[:LEVEL] {<current> MAXIMUM MINIMUM}	Set under current protection level	Yes
Set Under Current Protection Shutdown State	[[:]SOURCE] [<channel>]:CURRENT:PROTECTION:UNDER:STATE {<on-off-state>}	Select under current protection to shutdown (ON) or set alarm (OFF)	Yes
Query Under Current Protection Tripped	[[:]SOURCE] [<channel>]:CURRENT:PROTECTION:UNDER:TRIPPED?	Query if under current protection mechanism has tripped	N/A
Set Over Voltage Protection Level	[[:]SOURCE] [<channel>]:VOLTAGE:PROTECTION[:OVER] [:LEVEL] {<voltage> MAXIMUM MINIMUM}	Set the over voltage protection level	Yes
Query Over Voltage Protection Tripped	[SOURCE] [<channel>]:VOLTAGE:PROTECTION[:OVER]:TRIPPED?	Query if over voltage protection mechanism has tripped	N/A
Set Under Voltage Protection Level	[[:]SOURCE] [<channel>]:VOLTAGE:PROTECTION:UNDER[:LEVEL] {<voltage> MAXIMUM MINIMUM}	Set under voltage protection level	N/A
Set Under Voltage Protection Shutdown State	[[:]SOURCE] [<channel>]:VOLTAGE:PROTECTION:UNDER:STATE {<on-off-state>}	Select under voltage protection to shutdown (ON) or set alarm (OFF)	Yes
Query Under Voltage Protection Tripped	[[:]SOURCE] [<channel>]:VOLTAGE:PROTECTION:UNDER:TRIPPED?	Query if under voltage protection mechanism has tripped	N/A
Set High Current Limit	[[:]SOURCE] [<channel>]:CURRENT:LIMIT:HIGH {<current> MAXIMUM MINIMUM}	Set upper limit of current setpoint range (soft limits)	Yes
Set Low Current Limit	[[:]SOURCE] [<channel>]:CURRENT:LIMIT:LOW {<current> MAXIMUM MINIMUM}	Set lower limit of current setpoint range (soft limits)	Yes

Set High Voltage Limit	[[:]SOURCE] [<channel>] :VOLTage:LIMIT:HIGH {<voltage> MAXimum MINimum}	Set upper limit of voltage setpoint range (soft limits)	Yes
Set Low Voltage Limit	[[:]SOURCE] [<channel>] :VOLTage:LIMIT:LOW {<voltage> MAXimum MINimum}	Set lower limit of voltage setpoint range (soft limits)	Yes

Table B.4Commands for Current Share

Function	SCPI Command	Description	Query
Set Current Sharing Mode	[[:]SOURCE] [<channel>] :COMBine:CSHare:MODE {NONE MASTER SLAVE}	Select current share mode	Yes
Read Summed Current	[[:]MEASure [:SCALAR] :CURRENT [:DC] ? SUM	Read total current output of all current sharing supplies	N/A

Table B.5Commands for Calibration

Function	SCPI Command	Description	Query
Restore Factory	[[:]CALibration [<channel>] :RESTore	Restores the calibration to the constants set at the factory	N/A
Change Calibration Password	[[:]CALibration [<channel>] [:SECure] :CODE <codeword>	Changes the calibration security code.	No
Set Calibration State	[[:]CALibration [<channel>] [:SECure] :STATE <on-off-state>, <codeword>	Change calibration state (mode)	Yes
Set Supply Output Current Level	[[:]CALibration [<channel>] :OUTPut:CURRENT:LEVEL {MINimum MAXimum}	Set output current calibration level	No
Enter Output Current Data	[[:]CALibration [<channel>] :OUTPut:CURRENT [:DATA] <current>	Set output current calibration data	No
Set Supply Output Voltage Level	[[:]CALibration [<channel>] :OUTPut:VOLTage:LEVEL {MINimum MAXimum}	Set voltage output calibration level	No
Enter Output Voltage Data	[[:]CALibration [<channel>] :OUTPut:VOLTage [:DATA] <voltage>	Set voltage output calibration data	No

Table B.6Command to Clear all Protection Mechanisms

Function	SCPI Command	Description	Query
Clear Output Protection	[[:]OUTPut [<channel>] :PROTEction:CLEAR	Clears the protection mechanism.	N/A

Table B.7 Commands for Fold Protection

Function	SCPI Command	Description	Query
Set Output Fold Delay	[[:]OUTPut [<channel>]: PROTECTION:FOLD:DELAY <delay>	Set the delay time (seconds) before fold protection is triggered.	Yes
Set Output Fold Mode	[[:]OUTPut [<channel>]: PROTECTION:FOLD[:MODE] {NONE CC CV}	Select which regulation mode to fold back (None, CV, CC, CP)	Yes
Query Fold Protection Tripped	[[:]OUTPut [<channel>]: PROTECTION:FOLD:TRIPPED?	Query if fold protection has tripped	N/A

Table B.8 Commands for Triggering

Function	SCPI Command	Description	Query
Set Immediate Initiation of Trigger System	[[:]INITIate [<channel>] [: IMMEDIATE]	Initiate a triggered event or sequence	N/A
Set Trigger Source	[[:]TRIGger [<channel>] [: SEQUENCE] : SOURCE {BUS EXTERNAL IMMEDIATE NONE}	Sets the trigger source for triggered setpoints	Yes

Table B.9 System Commands

Function	SCPI Command	Description	Query
Query System Error	[[:]SYSTEM [<channel>] : ERROR [: NEXT] ?	Returns the next error in the instrument's error queue	N/A
Recall Default Factory Preset	[[:]SYSTEM [<channel>] : RECALL:DEFAULT	Restore the factory preset values	N/A
Select Remote Control Source	[[:]SYSTEM [<channel>] : REMOTE:SOURCE { GPIB MCHANNEL }	Change the remote control source	Yes
Set Multichannel Address	[[:]SYSTEM [<channel>] : COMMUNICATE:MCHANNEL:ADDRESS <channel>	Select the multichannel unit address	Yes
Set GPIB Address	[[:]SYSTEM [<channel>] : COMMUNICATE:GPIB[:SELF]:ADDRESS <GPIB_address>	Configure GPIB address	Yes
Set GPIB Power On Service Request	[[:]SYSTEM [<channel>] : COMMUNICATE:GPIB[:SELF]:PONS:rq {ON OFF 0 1}	Configure GPIB PON SRQ	Yes
Set Remote Control Operation (Serial Interface)	[[:]SYSTEM [<channel>] : REMOTE:STATE {LOCAL REMOTE RWLOCK}	RS-232 Only. Change remote control mode	Yes
Query SCPI Version	[[:]SYSTEM [<channel>] : VERSION?	Returns the SCPI version to which the instrument complies. Format is YYYY.V	N/A

Table B.10 Status Commands

Function	SCPI Command	Description	Query
Query Operation Status Condition Register	[:]STATUS [<channel>]:OPERATION:CONDITION?	See Section 4, "Status Registers"	N/A
Set Operation Status Enable Register	[:]STATUS [<channel>]:OPERATION:ENABLE <status-enable>	See Table 4.1, on page 72 .	Yes
Query Operation Status Event Register	[:]STATUS [<channel>]:OPERATION[:EVENT]?	See Table 4.1, on page 72 .	N/A
Set Operation Status Negative Transition Register	[:]STATUS [<channel>]:OPERATION:NTransition <status-enable>	See Table 4.1, on page 72 .	Yes
Set Operation Status Positive Transition Register	[:]STATUS [<channel>]:OPERATION:PTransition <status-enable>	See Table 4.1, on page 72 .	Yes
Query Operation Status Current Sharing Condition Register	[:]STATUS [<channel>]:OPERATION:CShare:CONDITION?	See Table 4.6, on page 74 .	N/A
Set Operation Status Current Sharing Enable Register	[:]STATUS [<channel>]:OPERATION:CShare:ENABLE <status-enable>	See Table 4.6, on page 74 .	Yes
Query Operation Status Current Sharing Event Register	[:]STATUS [<channel>]:OPERATION:CShare[:EVENT]?	See Table 4.6, on page 74 .	N/A
Set Operation Status Current Sharing Negative Transition Register	[:]STATUS [<channel>]:OPERATION:CShare:NTransition <status-enable>	See Table 4.6, on page 74 .	Yes
Set Operation Status Current Sharing Positive Transition Register	[:]STATUS [<channel>]:OPERATION:CShare:PTransition <status-enable>	See Table 4.6, on page 74 .	Yes
Query Operation Status Remote Control Condition Register	[:]STATUS [<channel>]:OPERATION:RControl:CONDITION?	See Table 4.5, on page 74 .	N/A
Set Operation Status Remote Control Enable Register	[:]STATUS [<channel>]:OPERATION:RControl:ENABLE <status-enable>	See Table 4.5, on page 74 .	Yes
Query Operation Status Remote Control Event Register	[:]STATUS [<channel>]:OPERATION:RControl[:EVENT]?	See Table 4.5, on page 74 .	N/A
Set Operation Status Remote Control Negative Transition Register	[:]STATUS [<channel>]:OPERATION:RControl:NTransition <status-enable>	See Table 4.5, on page 74 .	Yes
Set Operation Status Remote Control Positive Transition Register	[:]STATUS [<channel>]:OPERATION:RControl:PTransition <status-enable>	See Table 4.5, on page 74 .	Yes

SCPI Command Reference

SCPI Command Summary

Query Operation Status Regulating Condition Register	[:]STATUS [< channel >] : OPERATION : REGULATING : CONDITION ?	See Table 4.2 , on page 72.	N/A
Set Operation Status Regulating Enable Register	[:]STATUS [< channel >] : OPERATION : REGULATING : ENABLE < status-enable >	See Table 4.2 , on page 72.	Yes
Query Operation Status Regulating Event Register	[:]STATUS [< channel >] : OPERATION : REGULATING [: EVENT] ?	See Table 4.2 , on page 72.	N/A
Set Operation Status Regulating Negative Transition Register	[:]STATUS [< channel >] : OPERATION : REGULATING : NTransition < status-enable >	See Table 4.2 , on page 72.	Yes
Set Operation Status Regulating Positive Transition Register	[:]STATUS [< channel >] : OPERATION : REGULATING : PTransition < status-enable >	See Table 4.2 , on page 72.	Yes
Query Operation Status Shutdown Condition Register	[:]STATUS [< channel >] : OPERATION : SHUTDOWN : CONDITION ?	See Table 4.3 , on page 73.	N/A
Set Operation Status Shutdown Enable Register	[:]STATUS [< channel >] : OPERATION : SHUTDOWN : ENABLE < status-enable >	See Table 4.3 , on page 73.	Yes
Query Operation Status Shutdown Event Register	[:]STATUS [< channel >] : OPERATION : SHUTDOWN [: EVENT] ?	See Table 4.3 , on page 73.	N/A
Set Operation Status Shutdown Negative Transition Register	[:]STATUS [< channel >] : OPERATION : SHUTDOWN : NTransition < status-enable >	See Table 4.3 , on page 73.	Yes
Set Operation Status Shutdown Positive Transition Register	[:]STATUS [< channel >] : OPERATION : SHUTDOWN : PTransition < status-enable >	See Table 4.3 , on page 73.	Yes
Query Operation Status Shutdown Protection Condition Register	[:]STATUS [< channel >] : OPERATION : SHUTDOWN : PROTECTION : CO NDITION ?	See Table 4.3 , on page 73.	N/A
Set Operation Status Shutdown Protection Enable Register	[:]STATUS [< channel >] : OPERATION : SHUTDOWN : PROTECTION : EN ABLE < status-enable >	See Table 4.3 , on page 73.	Yes
Query Operation Status Shutdown Protection Event Register	[:]STATUS [< channel >] : OPERATION : SHUTDOWN : PROTECTION [: E VENT] ?	See Table 4.3 , on page 73.	N/A
Set Operation Status Shutdown Protection Negative Transition Register	[:]STATUS [< channel >] : OPERATION : SHUTDOWN : PROTECTION : NT RANSITION < status-enable >	See Table 4.3 , on page 73.	Yes
Set Operation Status Shutdown Protection Positive Transition Register	[:]STATUS [< channel >] : OPERATION : SHUTDOWN : PROTECTION : PT RANSITION < status-enable >	See Table 4.3 , on page 73.	Yes

Preset Enable, Positive Transition and Negative Transition Status Registers	[:]STATUS [<channel>]:PRESet		N/A
Query Questionable Status Condition Register	[:]STATUS [<channel>]:QUESTIONable:CONDition?	See Table 4.7, on page 76.	N/A
Set Questionable Status Enable Register	[:]STATUS [<channel>]:QUESTIONable:ENABle <status-enable>	See Table 4.7, on page 76.	Yes
Query Questionable Status Event Register	[:]STATUS [<channel>]:QUESTIONable[:EVENT]?	See Table 4.7, on page 76.	N/A
Set Questionable Status Negative Transition Register	[:]STATUS [<channel>]:QUESTIONable:NTRansition <status-enable>	See Table 4.7, on page 76.	Yes
Set Questionable Status Positive Transition Register	[:]STATUS [<channel>]:QUESTIONable:PTRansition <status-enable>	See Table 4.7, on page 76.	Yes
Query Questionable Status Current Condition Register	[:]STATUS [<channel>]:QUESTIONable:CURRENT:CONDition?	See Table 4.9, on page 77.	N/A
Set Questionable Status Current Enable Register	[:]STATUS [<channel>]:QUESTIONable:CURRENT:ENABle <status-enable>	See Table 4.9, on page 77.	Yes
Query Questionable Status Current Event Register	[:]STATUS [<channel>]:QUESTIONable:CURRENT[:EVENT]?	See Table 4.9, on page 77.	N/A
Set Questionable Status Current Negative Transition Register	[:]STATUS [<channel>]:QUESTIONable:CURRENT:NTRansition <status-enable>	See Table 4.9, on page 77.	Yes
Set Questionable Status Current Positive Transition Register	[:]STATUS [<channel>]:QUESTIONable:CURRENT:PTRansition <status-enable>	See Table 4.9, on page 77.	Yes
Query Questionable Status Voltage Condition Register	[:]STATUS [<channel>]:QUESTIONable:VOLTage:CONDition?	See Table 4.8, on page 76.	N/A
Set Questionable Status Voltage Enable Register	[:]STATUS [<channel>]:QUESTIONable:VOLTage:ENABle <status-enable>	See Table 4.8, on page 76.	Yes
Query Questionable Status Voltage Event Register	[:]STATUS [<channel>]:QUESTIONable:VOLTage[:EVENT]?	See Table 4.8, on page 76.	N/A
Set Questionable Status Voltage Negative Transition Register	[:]STATUS [<channel>]:QUESTIONable:VOLTage:NTRansition <status-enable>	See Table 4.8, on page 76.	Yes
Set Questionable Status Voltage Positive Transition Register	[:]STATUS [<channel>]:QUESTIONable:VOLTage:PTRansition <status-enable>	See Table 4.8, on page 76.	Yes

Query the Standard Event register (ESR?)	[:]STATUS [<channel>]:STANDARD[:EVENT]?	See Table 4.10, on page 78 .	N/A
Enable the Standard Event register (*ESE,*ESE?)	[:]STATUS [<channel>]:STANDARD:ENABLE	See Table 4.10, on page 78 .	Yes
Query the Status Byte (*STB)	[:]STATUS [<channel>]:SBYTE[:EVENT]?	See Table 4.11, on page 79 .	N/A
Service Request Enable (*SRE,*SRE?)	[:]STATUS [<channel>]:SREQUEST:ENABLE <status-enable>	Set the bits in the Service Request Enable Register.	Yes

Table B.11 Protection Commands

Function	SCPI Command	Description	Query
Set Over Temperature Response	[:]SENSE [<channel>]:TEMPERATURE:PROTECTION:LATCH <on-off-state>	Select if output is latched off or auto recovers in the case of an over temperature condition	Yes
Query Over Temperature Protection Tripped	[:]SENSE [<channel>]:TEMPERATURE:PROTECTION:TRIPPED?	Query temperature protection tripped	N/A
Set AC Fail Response	[:]SENSE [<channel>]:VOLTAGE:AC:PROTECTION:LATCH <on-off-state>	Select if output is latched off or auto recovers in the case of an AC Fail	Yes
Query AC Fail Protection Tripped	[:]SENSE [<channel>]:VOLTAGE:AC:PROTECTION:TRIPPED?	Query AC protection circuit tripped	N/A

Table B.12 User Lines

Function	SCPI Command	Description	Query
Select polarity of Auxiliary Lines	[:]OUTPUT [<channel>]:AUXILIARY<A B>:POLARITY {HIGH LOW}	Configure the polarity of the auxiliary line	Yes
Select Source of Auxiliary Line State	[:]OUTPUT [<channel>]:AUXILIARY<A B>:SOURCE <aux_line_mnemonic>	Configure the auxiliary line	Yes
Query state of Auxiliary Line	[:]OUTPUT [<channel>]:AUXILIARY<A B>:STATE?	Query the state of the auxiliary line	N/A

Table B.13 Output State

Function	SCPI Command	Description	Query
Set Output State	[:]OUTPUT [<channel>]:[STATE] <on-off-state>	Enable/disable the power supply output.	Yes
Set Output State at Power-On	[:]OUTPUT [<channel>]:PON:STATE <on-off-state>	Selects the state of the output at power-on	Yes
Power-On Configuration	[:]OUTPUT [<channel>]:PON:RECALL {PRESET USER<setting_location> SEQ<sequence_number>}	Configure the supply to recall last setting, one of the user settings, factory preset values or to enable an auto sequence.	Yes

Table B.14 Auto Sequence Commands

Function	SCPI Command	Description	Query
Delete selected sequence	[:]PROGRAM [<channel>] [:SELECTED] :DELETE [:SELECTED]	The selected sequence is deleted	N/A
Delete all sequences	[:]PROGRAM [<channel>] [:SELECTED] :DELETE :ALL	All sequences are deleted	N/A
Select a sequence to run or edit	[:]PROGRAM [<channel>] [:SELECTED] :NAME <sequence_number>	Select sequence to run or edit	Yes
Change Auto Sequence operating state	[:]PROGRAM [<channel1>] [:SELECTED] :STATE {RUN PAUSE STOP}	Change operating state of current auto sequence	Yes
Skip to the next step (while running in auto sequence)	[:]PROGRAM [<channel1>] [:SELECTED] :STEP :NEXT	Skip to start of next step. Error if STATE is not RUN	N/A
Read selected sequence number of steps	[:]PROGRAM [<channel1>] [:SELECTED] :COUNT ?	Read number of programmed steps in selected sequence	Yes
Delete selected sequence step	[:]PROGRAM [<channel1>] [:SELECTED] :STEP <step_number> :DELETE	Delete the selected sequence step	N/A
Query executed repetitions	[:]PROGRAM [<channel1>] [:SELECTED] :EXECUTING ?	Query the number of repetitions that have been completed.	N/A
Exit a selected sequence	[:]PROGRAM [<channel1>] [:SELECTED] :EXIT	Exit a selected sequence	N/A
Read current step number	[:]PROGRAM [<channel1>] [:SELECTED] :STEP :EXECUTING ?	Query current step in execution	N/A
Edit selected sequence step	[:]PROGRAM [<channel1>] [:SELECTED] :STEP <step_number> [:EDIT] [[:<voltage>], <current>], <OVP_level>], {<time> TRIG}]	Edit the selected sequence step	Yes
Insert step into selected sequence	[:]PROGRAM [<channel1>] [:SELECTED] :STEP <step_number> :INSERT [[:<voltage>], <current>], <OVP_level>], {<step_time> TRIG}]	Insert a step into the selected sequence	N/A
Program selected sequence step current	[:]PROGRAM [<channel1>] [:SELECTED] :STEP <step_number> :CURRENT <current>	Edit/program step current of selected sequence	Yes
Program selected sequence step voltage	[:]PROGRAM [<channel1>] [:SELECTED] :STEP <step_number> :VOLTAGE <voltage>	Edit/program step voltage of selected sequence	Yes
Program selected step OVP	[:]PROGRAM [<channel1>] [:SELECTED] :STEP <step_number> :OVP <step_number> :OVP <OVP_level>	Edit/program step OVP level of selected sequence	Yes
Program selected sequence step time	[:]PROGRAM [<channel1>] [:SELECTED] :STEP <step_number> :STEP :TIME {<step_time> TRIG}	Edit/program step time or triggering of selected sequence	Yes
Program selected sequence trigger source	[:]PROGRAM [<channel1>] [:SELECTED] :TRIGGER :SOURCE {BUS MANUAL EXTERNAL IMMEDIATE}	Edit/program trigger source of selected sequence	Yes
Program selected sequence end action	[:]PROGRAM [<channel1>] [:SELECTED] :REPEAT {<sequence_count> ONCE FOREVER INFINITY}	Edit/program end action of selected sequence	Yes
Read specific sequence number of steps	[:]PROGRAM [<channel1>] :SEQUENCE <sequence_number> :STEP :COUNT ?	Read number of programmed steps in specific sequence	Yes
Delete a specific sequence	[:]PROGRAM [<channel1>] :SEQUENCE <sequence_number> :DELETE	The specific sequence is deleted	N/A

SCPI Command Reference

SCPI Command Summary

Delete specific sequence step	[:]PROGRAM[<channel>]:SEQUENCE<sequence_number>:STEP<step_number>;DELETE	Delete a specific sequence step	N/A
Edit specific sequence step	[:]PROGRAM[<channel>]:SEQUENCE<sequence_number>:STEP<step_number>[:EDIT][[<voltage>],<current>],<OVP_level>],{<time> TRIG}}	Edit a specific sequence step	Yes
Insert step into specific sequence	[:]PROGRAM[<channel>]:INSERT[[<voltage>],<current>],<OVP_level>],{<step_time TRIG}}	Insert a step into a specific sequence	N/A
Program specific sequence step current	[:]PROGRAM[<channel>]:CURRENT <current>	Edit/program step current of specific sequence	Yes
Program specific sequence step voltage	[:]PROGRAM[<channel>]:VOLTAGE <voltage>	Edit/program step voltage of specific sequence	Yes
Program specific step OVP	[:]PROGRAM[<channel>]:OVP <OVP_level>	Edit/program step OVP level of specific sequence	Yes
Program specific sequence step time	[:]PROGRAM[<channel>]:SEQUENCE<sequence_number>:STEP<step_number>;DWELL {<step_time> TRIG}	Edit/program step time or triggering of specific sequence	Yes
Program specific sequence trigger source	[:]PROGRAM[<channel>]:SOURCE {BUS MANUAL EXTERNAL IMMEDIATE}	Edit/program trigger source of specific sequence	Yes
Program specific sequence end action	[:]PROGRAM[<channel>]:REPEAT {<sequence_count> ONCE FOREVER INFINITY}	Edit/program end action of specific sequence	Yes

Expressions

Table B.15 Expressions

Expression	Details
aux_line_mnemonic	Define the output of the auxiliary line. The possible values are NONE, ON, OFF, OVOLTage, UVOLTage, OCURrent, ACOFF, OTEMPerature, SPRotection, UNRRegulated, FOLD, CC, CV, CP.
channel	The address for a multichannel slave. An integer value in the range 2 to 50.
codeword	A string representing any 4-digit positive integer.
current	A numeric value as defined by SCPI. May also be <i>MAXimum</i> or <i>MINimum</i> . May include current-related suffix units such as "mA", "uA", "A" etc. Range may be 0 to 103% of model's rated current.
delay	A length of time in the range 0 to 60 seconds. May include time-related suffix units such as "S", "MIN", "mS", "uS" etc. By default, the value is in seconds.
ESE-word	Range 0–255. An 8-bit status mask for the Standard Event Status Register that determines which bits are OR'd to form the ESB bit in the Status Byte Register.
GPIB_address	The address for a GPIB controlled unit. An integer value in the range 1 to 30.
on-off-state	A Boolean indicator of a state. Possible values are ON, OFF, 0 (off), or 1 (on).
OVP_level	A numeric value as defined by SCPI. May also be <i>MAXimum</i> or <i>MINimum</i> . May include voltage-related suffix units such as "mV", "uV", "V", etc. Range is 0 to 103% of model's rated voltage.
setting_location	A numeric indication of an internal set of setting registers. An integer value in the range 1 to 10.
sequence_count	Number of times a sequence is to be repeated. Range is 1 to 9999.
sequence_number	The name of an auto sequence program. Range is 1 to 10. The suffix is part of the SEQUENCE command name and is not a parameter.
status-enable	A 16-bit status mask for any condition register that determines which bits are to be used for synthesizing the summary bit of that register.
step_number	The step number of an auto sequence program. Possibly considered a SCPI suffix. Range is 1 to 99.
step_time	The duration of an auto sequence step in the format hh:mm:ss.s. May include time-related suffix units such as "S", "MIN", "mS", "uS", etc. By default, the value is in seconds.
voltage	A numeric value as defined by SCPI. May also be <i>MAXimum</i> or <i>MINimum</i> . May include voltage-related suffix units such as "mV", "uV", "V", etc. Range is 0 to 103% of model's rated voltage.

SCPI Command Reference

Expressions

Appendix C. Error Messages

Overview

Errors are placed in a queue as they are detected. The queue works on a first in, first out (FIFO) basis. If the queue overflows, the last error in the queue is replaced with error -350, "Queue Overflow". When all errors have been read from the queue, further error queries return 0, "No error".

The error queue is cleared when any of the following occur (IEEE 488.2, section 11.4.3.4):

- Upon receipt of a *CLS command
- Upon reading the last item from the queue

All negative values are reserved by the SCPI standard. All errors unique to the power supply have positive values.

Command Error List

An error in the range [-199, -100] indicates that an IEEE 488.2 syntax error has been detected by the instrument's parser. The occurrence of any error in this class causes the command error bit (bit 5) in the Event Status Register to be set.

Table C.1 Command Error List

Error code	Error Message Description
-100	Command error This is the generic syntax error.
-105	GET not allowed A Group Execute Trigger was received within a program message.
-114	Header suffix out of range The value of a numeric suffix attached to a program mnemonic is out of range. May refer to multichannel addressing, auto sequence number or auto sequence step number.
-120	Numeric data error This error is generated when parsing a data element which appears to be numeric, including the non-decimal numeric types.
-123	Exponent too large The magnitude of the exponent was larger than 32000.
-151	Invalid string data The data with the enclosed ("") double apostrophes (string) is invalid. Possibility of wrong length or character.

Execution Error List

An error in the range [-299, -200] indicates that an error has been detected by the instrument's execution control block. The occurrence of any error in the class causes the execution error bit (bit 4) in the Event Status Register to be set.

Execution errors are reported by the device after rounding and expression evaluation operations have taken place.

Table C.2 Execution Error List

Error code	Error Message Description
-200	Execution error This is the generic error for the power supply.
-203	Command protected Indicates that a legal password-protected program command or query could not be executed because the command was disabled. Check calibration state.

Error code	Error Message Description
-220	Parameter error Indicates that a program data element related error occurred.
-221	Setting conflict Indicates that a legal program data element was parsed but could not be executed due to the current power supply state. Factors that may contribute to this error are: Remote source - To set most values, the remote source must be correct. Remote state - To set most values, the unit must be in remote mode. Calibration mode - when in calibration mode, certain settings will cause as error. Current share mode - When the unit is in current share mode (other than none) certain settings will cause an error.
-222	Data out of range Indicates that a legal command could not be executed because the interpreted value was outside the legal range as defined by the power supply.
-225	Out of memory The power supply has insufficient memory to perform the requested operation.
-231	Data questionable Indicates that measurement accuracy is suspect.
-240	Hardware error (occurs during flash update if there is a failure) Indicates that a legal program command or query could not be executed because of a hardware problem in the power supply.
-241	Hardware missing Indicates that a legal program command or query could not be executed because of missing power supply hardware; e.g. an option not installed.
-282	Illegal program name The name used to reference an auto sequence program was invalid or there is no program selected.
-284	Program currently running Certain operations dealing with auto sequence programs may be illegal while the program is running. For example, deleting a running program is not possible.
-285	Program syntax error There is an error in the program definition.
-290	Memory use error Indicates that a user request has directly or indirectly caused an error related to memory or <data_handle>s. This is not the same as "bad" memory.

Error Messages

Device-Specific Error List

Device-Specific Error List

An error in the range [-399, 300] or [1, 32767] indicates that the instrument has detected an error which is not a command error, a query error, or an execution error; some device operations did not properly complete, possibly due to an abnormal hardware or firmware condition. These codes are also used for self-test response errors. The occurrence of any error in the class causes the device-specific error bit (bit 3) in the Event Status Register to be set.

Table C.3 Device-Specific Error List

Error code	Error Message Description
-300	Device-specific error. Indicates that the power supply could not complete the operation due to some condition of the power supply.
-310	System error. This error is queued when the power supply cannot convert the input to a calibrated value.
-313	Calibration memory lost.
-314	Save/recall memory lost. Indicates that the non-volatile data saved by the *SAV command has been lost.
-315	Configuration memory lost. Indicates that non-volatile configuration data saved by the power supply has been lost.
-321	Out of memory. An internal operation needed more memory than was available.
-330	Self-test failed.
-350	Queue overflow. A specific code entered into the queue in lieu of the code that caused the error. This code indicates that there is no room in the queue and an error occurred but was not recorded.
-360	Communication error. This is the generic communication error for errors which cannot be classified below.
-361	Parity error in program message. Parity bit not correct when data received.
-362	Framing error in program message. A stop bit was not detected when data was received, e.g. a baud rate mismatch.
-363	Input buffer overrun. Software or hardware input buffer on serial port overflows with data caused by improper (or nonexistent) pacing.

Query Error List

An error number in the range [-499, -400] indicates that the output queue control of the instrument has detected a problem with the message exchange protocol described in IEEE 488.2, chapter 6. The occurrence of any error in this class causes the query error bit (bit 2) in the Event Status Register to be set.

Table C.4 Query Error List

Error code	Error Message Description
-400	Query Error This is the generic query error for the power supply, used only when the other types of errors do not apply.
-410	Query INTERRUPTED Generated when a new command was received before it could finish the query.

User Request Event

An error/event in the range [-699, -600] is used when the instrument wishes to report a 488.2 user request event. This event also sets the user request bit (bit 6) of the Standard Event Status Register.

Table C.5 User Request Event

Error code	Error Message Description
-600	User request

Operation Complete Event

An error/event in the range [-899, -800] is used when the instrument wishes to report a 488.2 operation complete event. This event occurs when an instrument's synchronization protocol, having been enabled by an *OPC command, completes all selected pending operations. This event also sets the operation complete bit (bit 0) of the Standard Event Status Register.

Table C.6 Operation Complete Event

Error code	Error Message Description
-800	Operation complete

Error Messages

Front Panel Error Codes

Front Panel Error Codes

Table C.7 Front Panel Error Codes

Error code	Error Message Description
+1301	Front Panel Protocol Error Invalid data from the front panel was sent to the CPU
+1302	Front Panel Not Responding
+1303	Front Panel Self-Test Failed

CPU Error Codes

Table C.8 CPU Error Codes

Error code	Error Message Description
+1401	ColdFire Self-Test Failed

Analog Programming Interface Error codes

Table C.9 Analog Programming Interface Error code

Error code	Error Message Description
+1501	Analog programming self-test failed

Auto Sequencing Error Codes

Table C.10 Auto Sequencing Error Codes

Error code	Error Message Description
+1601	Invalid step number Step does not exist, is out of allowed range or preceding steps do not exist.

CANbus Error Codes

Table C.11 CANbus Error Codes

Error code	Error Message Description
+1701	CANbus hardware missing The CANbus option is not installed on the controller card, or controller card is not present.
+1702	CANbus device specific error An error has occurred on the CANbus circuit. Probable causes are AC input too low, AC input not secure, controller card not securely fastened or other noise sources.
+1703	CANbus input buffer corrupted.
+1704	CANbus input buffer corrupted.
+1705	CANbus input buffer overrun. Data is sent on the CANbus faster than the CPU can process.
+1706	CANbus output buffer overrun. Data cannot be transmitted fast enough.

Multichannel Error Codes

Table C.12 Multichannel Error Codes

Error code	Error Message Description
+1800	Multichannel general error An error has occurred while sending multichannel commands. One such cause is sending a command that is too long.
+1802	Multichannel address taken The multichannel address configured for this unit has already been assigned to another unit on the CANbus network.
+1803	Multichannel originator not responding The originator of the message is not responding to the handshaking.
+1804	Multichannel recipient not responding The recipient of the message is not acknowledging the reception of the command.
+1805	Multichannel command overwritten A received command through the CANbus has been overwritten.

Error Messages

Current Share Error Codes

Current Share Error Codes

Table C.13 Current Share Error Codes

Error code	Error Message Description
+1900	Current Share General Error
+1911	Current share master already online A unit on the CANbus network has already been assigned the current share master unit. Only one is allowed per network.
+1912	Current share slave lost One of the connected current share slaves have not responded in time.
+1921	Current share master lost The assigned master has not responded in time.
+1922	Current share slave connection refused Connection as a slave on the current share network has been refused due to one of the following reasons: 4 slaves are already online, the voltage rating does not match those of the master's, the current rating does not match those of the master's.
+1924	Current share data out of range The voltage or current readback or setpoint values passed are out of range.
+1925	Current share slave output off by unknown One of the slave's output is off because of unknown reasons
+1926	Current share slave output off by command One of the slave's output is off because of a command from a remote source or the front panel.
+1927	Current share slave output off by AC fail One of the slave's output is off because of an AC fail condition.
+1928	Current share slave output off by OTP (Over Temperature Protection) One of the slave's output is off because of an OTP condition.

Appendix D. Calibration

Overview

The calibration of the unit is software dependent; there are no potentiometers to adjust.

The calibration points are set to 10% and 90% of the rated outputs and calibration data is automatically calculated from the measurement date you provide.

The setting and readback accuracy of the power supply should be checked annually, and calibration done only if the unit is not operating within its specification.

The OTP and AC off protection mechanisms are operational during calibration. All other protection mechanisms are disabled.

Entering Calibration Mode



CAUTION

Calibration procedures should only be performed by qualified users. Failure to adhere to this warning may cause damage to the power supply, or pose a safety hazard for the user.

Calibration mode is entered by using the "change calibration state" SCPI command. Ensure you are in remote mode and have the appropriate remote source setting.

To access calibration mode via remote interface, use the command:

```
CAL:STAT ON, "0000"1
```

To check if the power supply is in calibration mode, use the command:

```
CAL:STAT?
```

1. where the parameter "0000" may be replaced with your own 4-digit security code.

Calibration

Setup and Equipment

Security code To protect calibration data, a security code is required to enter calibration mode. The security code set at the factory to "0000." The password can be changed. Calibration state must be ON to change the password.

The SCPI command to change the security code is:

```
CAL:CODE <security_code>
```

The security code is any 4-digit number enclosed by quotation marks. Trying to change the password to an invalid one causes an error.

Setup and Equipment

To calibrate the option card you will need:

- 6 digit DVM
- current shunt
- variable load
- Load wiring sized for the maximum available output current.

To set up to calibrate output voltage and current:

Connect a load to the output of the power supply and a current shunt in series.

You will need to use the DVM to measure both the voltage at the output of the power supply and the voltage across the shunt. You will need to convert the voltage across the shunt to a current measurement.

Calibration Procedure

Calibration of programming and readback are combined in a single procedure.

Output Voltage

1. Set the load to open circuit. Attach a DVM across the output terminals.

2. *Minimum calibration level*

Set the output voltage to 10% by sending the command:

CAL:OUTP:VOLT:LEV MIN

3. *Enter voltage data*

Enter the voltage read from the external DVM.

CAL:OUTP:VOLT:DATA <voltage>

4. *Maximum calibration level*

Set the output voltage to 90% by sending the command:

CAL:OUTP:VOLT:LEV MAX

5. *Enter voltage data*

Enter the voltage read from the external DVM.

CAL:OUTP:VOLT:DATA <voltage>

6. Power supply calculates and stores calibration constants.

Calibration

Calibration Procedure

Output Current

1. Set the power supply and load operate at full output. You must ensure the power supply is operating in current mode during current calibration. Place a shunt on the load line so that you can measure the current. Attach a DVM across the shunt
2. *Minimum calibration level*
Set the output current to 10% by sending the command:
CAL:OUTP:CURR:LEV MIN
3. *Enter current data*
Enter the current read from the external DVM via the shunt.
CAL:OUTP:CURR:DATA <current>
4. *Maximum calibration level*
Set the output current to 90% by sending the command:
CAL:OUTP:CURR:LEV MAX
5. *Enter current data*
Enter the current read from the shunt via the external DVM.
CAL:OUTP:CURR:DATA <current>
6. Power supply calculates and stores calibration constants.

Exit calibration mode

When you have completed calibration, exit calibration mode by sending the command:

```
CAL:STAT OFF, "0000"
```

where "0000" is replaced with your security code.

Restore Factory Calibration

Restore the unit to the calibration constants set at the factory by sending the command:

```
CALibration:REStore
```

Note This procedure should not be used in place of regular calibration, but may be useful to restore the unit to an operational state in case of failure.

Calibration

Restore Factory Calibration

Xantrex Technology Inc.

8999 Nelson Way
Burnaby, British Columbia
Canada V5A 4B5

604 422 8595 Tel
604 421 3056 Fax
800 667 8422 Toll Free North America
prg.info@xantrex.com
www.xantrex.com

Free Manuals Download Website

<http://myh66.com>

<http://usermanuals.us>

<http://www.somanuals.com>

<http://www.4manuals.cc>

<http://www.manual-lib.com>

<http://www.404manual.com>

<http://www.luxmanual.com>

<http://aubethermostatmanual.com>

Golf course search by state

<http://golfingnear.com>

Email search by domain

<http://emailbydomain.com>

Auto manuals search

<http://auto.somanuals.com>

TV manuals search

<http://tv.somanuals.com>