

Smart choice for power

xantrex

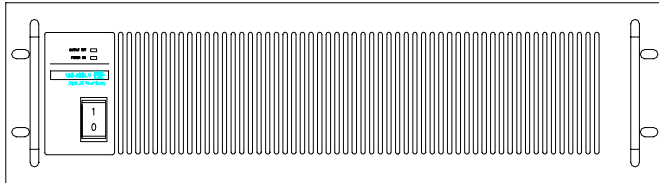

XDC 10-600SL
XDC 20-300SL
XDC 30-200SL
XDC 40-150SL
XDC 60-100SL
XDC 80-75SL
XDC 100-60SL
XDC 150-40SL
XDC 300-20SL
XDC 600-10SL

Operating Manual

XDC 6000 Watt Series Slave Power Supply

www.xantrex.com

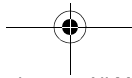
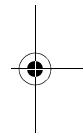
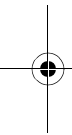
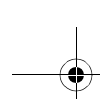

xantrex™

**Operating Manual for
XDC 6000 Watt Series
Slave Power Supply**

Limited Warranty

What does this warranty cover and how long does it last?

This Limited Warranty is provided by Xantrex Technology, Inc. (“Xantrex”) and covers defects in workmanship and materials in your **XDC 6000 Watt Series Slave Power Supply**. This warranty lasts for a Warranty Period of **5 years** from the date of purchase at point of sale to you, the original end user customer.

What will Xantrex do?

Xantrex will, at its option, repair or replace the defective product free of charge, provided that you notify Xantrex of the product defect within the Warranty Period, and provided that Xantrex through inspection establishes the existence of such a defect and that it is covered by this Limited Warranty.

Xantrex will, at its option, use new and/or reconditioned parts in performing warranty repair and building replacement products. Xantrex reserves the right to use parts or products of original or improved design in the repair or replacement. If Xantrex repairs or replaces a product, its warranty continues for the remaining portion of the original Warranty Period or 90 days from the date of the return shipment to the customer, whichever is greater. All replaced products and all parts removed from repaired products become the property of Xantrex.

Xantrex covers both parts and labor necessary to repair the product, and return shipment to the customer via a Xantrex-selected non-expedited surface freight within the contiguous United States and Canada. Alaska and Hawaii are excluded. Contact Xantrex Customer Service for details on freight policy for return shipments outside of the contiguous United States and Canada.

How do you get service?

If your product requires troubleshooting or warranty service, contact your merchant. If you are unable to contact your merchant, or the merchant is unable to provide service, contact Xantrex directly at:

Phone:	604 422 2777
Toll Free North America:	1 800 670 0707
Fax:	604 420 2145
Email:	customerservice@xantrex.com

Direct returns may be performed according to the Xantrex Return Material Authorization Policy described in your front panel controlled XDC product manual. For some products, Xantrex maintains a network of regional Authorized Service Centers. Call Xantrex or check our website to see if your product can be repaired at one of these facilities.

In any warranty claim, dated proof of purchase must accompany the product and the product must not have been disassembled or modified without prior written authorization by Xantrex.

Proof of purchase may be in any one of the following forms:

- The dated purchase receipt from the original purchase of the product at point of sale to the end user, or
- The dated dealer invoice or purchase receipt showing original equipment manufacturer (OEM) status, or
- The dated invoice or purchase receipt showing the product exchanged under warranty

What does this warranty not cover?

This Limited Warranty does not cover normal wear and tear of the product or costs related to the removal, installation, or troubleshooting of the customer's electrical systems. This warranty does not apply to and Xantrex will not be responsible for any defect in or damage to:

- a. the product if it has been misused, neglected, improperly installed, physically damaged or altered, either internally or externally, or damaged from improper use or use in an unsuitable environment;
- b. the product if it has been subjected to fire, water, generalized corrosion, biological infestations, and high input voltage from lightning strikes;
- c. the product if repairs have been done to it other than by Xantrex or its authorized service centers (hereafter "ASCs");
- d. the product if it is used as a component part of a product expressly warranted by another manufacturer;
- e. the product if its original identification (trade-mark, serial number) markings have been defaced, altered, or removed.

Disclaimer Product

THIS LIMITED WARRANTY IS THE SOLE AND EXCLUSIVE WARRANTY PROVIDED BY XANTREX IN CONNECTION WITH YOUR XANTREX PRODUCT AND IS, WHERE PERMITTED BY LAW, IN LIEU OF ALL OTHER WARRANTIES, CONDITIONS, GUARANTEES, REPRESENTATIONS, OBLIGATIONS AND LIABILITIES, EXPRESS OR IMPLIED, STATUTORY OR OTHERWISE IN CONNECTION WITH THE PRODUCT, HOWEVER ARISING (WHETHER BY CONTRACT, TORT, NEGLIGENCE, PRINCIPLES OF MANUFACTURER'S LIABILITY, OPERATION OF LAW, CONDUCT, STATEMENT OR OTHERWISE), INCLUDING WITHOUT RESTRICTION ANY IMPLIED WARRANTY OR CONDITION OF QUALITY, MERCHANTABILITY OR FITNESS FOR A PARTICULAR PURPOSE. ANY IMPLIED WARRANTY OF MERCHANTABILITY OR FITNESS FOR A PARTICULAR PURPOSE TO THE EXTENT REQUIRED UNDER APPLICABLE LAW TO APPLY TO THE PRODUCT SHALL BE LIMITED IN DURATION TO THE PERIOD STIPULATED UNDER THIS LIMITED WARRANTY.

IN NO EVENT WILL XANTREX BE LIABLE FOR ANY SPECIAL, DIRECT, INDIRECT, INCIDENTAL OR CONSEQUENTIAL DAMAGES, LOSSES, COSTS OR EXPENSES HOWEVER ARISING WHETHER IN CONTRACT OR TORT INCLUDING WITHOUT RESTRICTION ANY ECONOMIC LOSSES OF ANY KIND, ANY LOSS OR DAMAGE TO PROPERTY, ANY PERSONAL INJURY, ANY DAMAGE OR INJURY ARISING FROM OR AS A RESULT OF MISUSE OR ABUSE, OR THE INCORRECT INSTALLATION, INTEGRATION OR OPERATION OF THE PRODUCT.

Exclusions If this product is a consumer product, federal law does not allow an exclusion of implied warranties. To the extent you are entitled to implied warranties under federal law, to the extent permitted by applicable law they are limited to the duration of this Limited Warranty. Some states and provinces do not allow limitations or exclusions on implied warranties or on the duration of an implied warranty or on the limitation or exclusion of incidental or consequential damages, so the above limitation(s) or exclusion(s) may not apply to you. This Limited Warranty gives you specific legal rights. You may have other rights which may vary from state to state or province to province.

Information

WITHOUT LIMITING THE GENERALITY OF THE FOREGOING, UNLESS SPECIFICALLY AGREED TO BY IT IN WRITING, XANTREX

- a. MAKES NO WARRANTY AS TO THE ACCURACY, SUFFICIENCY OR SUITABILITY OF ANY TECHNICAL OR OTHER INFORMATION PROVIDED IN MANUALS OR OTHER DOCUMENTATION PROVIDED BY IT IN CONNECTION WITH THE PRODUCT; AND
- b. ASSUMES NO RESPONSIBILITY OR LIABILITY FOR LOSSES, DAMAGES, COSTS OR EXPENSES, WHETHER SPECIAL, DIRECT, INDIRECT, CONSEQUENTIAL OR INCIDENTAL, WHICH MIGHT ARISE OUT OF THE USE OF SUCH INFORMATION.

THE USE OF ANY SUCH INFORMATION WILL BE ENTIRELY AT THE USER'S RISK.

**WARNING:
Limitations
on Use**

Please refer to your product user manual for limitations on uses of the product. Specifically, please note that this power supply is not intended for use in connection with life support systems and Xantrex makes no warranty or representation in connection with any use of the product for such purposes.

Xantrex Technology, Inc.
8999 Nelson Way
Burnaby, British Columbia
Canada V5A 4B5

**Information
About Your
Power
Supply**

Please record the following information when you first open your Power Supply package:

Model Number	_____
Serial Number	_____
Purchased From	_____
Purchase Date	_____

Release Release 1.0 (2002-09)

Warnings and Cautions

Warnings and cautions are defined and formatted in this manual as shown below.



WARNING

Describes a potential hazard which could result in injury or death, or, a procedure which, if not performed correctly, could result in injury or death.



CAUTION

Describes a procedure which, if not performed correctly, could result in damage to data, equipment, or systems.

Power Supply Safety



WARNING—High Energy and High Voltage

Exercise caution when using and calibrating a power supply. High energy levels can be stored at the output voltage terminals on a power supply in normal operation. In addition, potentially lethal voltages exist in the power circuit and on the output and sense connectors of a power supply with a rated output greater than 40 V. Filter capacitors store potentially dangerous energy for some time after power is removed.



CAUTION

Operate the power supply in an environment free of flammable gases or fumes. To ensure that the power supply's safety features are not compromised, use the power supply as specified in this manual and do not substitute parts or make any unauthorized modifications. Contact the service technician for service and repair help. Repairs must be made by experienced service technicians only.



CAUTION

For Use as a Battery Charger

When you are using any of these power supplies for battery charging applications, it is essential to provide an appropriately sized fuse or circuit breaker in series between the power supply output and the battery.

Installation of a protector (fuse or DC circuit breaker) rated for about 115% of the maximum current rating of the power supply and designed specifically to interrupt the DC voltage of the battery, will provide adequate reverse polarity current protection. Where several power supplies are in parallel, it is best to fuse each one, rather than one large fuse for all.

Approvals **CE Mark**

CE-marked units meet the following standards:

- IEC 1010-1-92 including Amendments 1 and 2:
 - Overvoltage Category II
 - Permanently Connected Equipment
 - Pollution Degree 2
- EN50081-2-1996 Electromagnetic Generic Emission - Industrial Equivalent
- EN50082-2-1995 Electromagnetic Compatibility Generic Immunity - Industrial Environment

CSA Certified

CSA C22.2 No. 1010.1-92

UL Listed (pending)

Meets UL3101-1 Electrical Equipment for Laboratory Use; Part 1: General Requirements

General safety requirements for electrical equipment intended for professional, industrial process, and educational use, including equipment and computing devices for: measurement and test; control; laboratory use; and accessories intended for use with the above.

FCC Compliance

FCC Part 15 - Radio Frequency Devices - Class A Limits

Canadian EMC Requirements

The unit complies with Canadian EMC requirements of ICES-001.

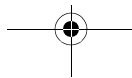
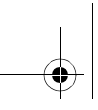

About This Manual

This Operating Manual contains operating instructions for the XDC Series Slave power supplies. This power supply is based on the XDC Series of digital, programmable power supplies, with the same high level of accuracy and reliability, but specifically designed with no front panel interface for use as a slave unit controlled via CANbus (Control Area Network bus).

Who Should Use This Manual

This manual is designed for users who understand basic electrical theory, especially as applied to the operation of power supplies. This implies a recognition of constant voltage and constant current operating modes and the control of input and output power, as well as the observance of safe techniques while making connections to the supply and any changes in settings.

This manual is intended to be used in conjunction with the full digital front panel XDC Series Operating manual. If you do not plan to use this power supply in a system with a full digital front panel XDC Series power supply, please contact the manufacturer for additional application data.

Revisions

The current release of this manual is listed in the right-hand page footer. Insert pages may update already-printed manuals.

Release 1.0 (2002-09)

About This Manual

Table of Contents

About This Manualix
 Table of Contentsxi

Section 1. Overview

Features13
 Front Panel14

Section 2. AC Input Power

AC Input Connector16
 AC Input Wire16
 AC Wire Input Connection17

Section 3. Current Sharing

Overview19
 Theory of Operation19
 CANbus Setup20
 Current Share Configuration21
 Setup Current Sharing Network21
 Operation22
 Errors22
 Specifications22

Appendix A. Specifications and Characteristics

Electrical Specifications—Summary24
 AC Line Input Specifications26
 AC Line Input Voltage Operating Ranges26
 Output Performance Specifications27
 Environmental Specification31
 Thermal Specification31
 Humidity Specification31
 International Approvals31
 Mechanical Specification32
 Weight32
 Size32

Table of Contents

Section 1. Overview

The XDC series Slave power supply is designed for use in current sharing systems as a slave module connected in parallel with an XDC 6000 Watt series full digital controlled front panel unit. In such a configuration, the XDC full digital controlled front panel unit is acting as the master of the current sharing system. The communication between the master and slave is made via a CANbus digital interface to control all the parameters needed for proper current sharing.

The XDC 6000 Watt series full digital controlled front panel unit used as a master needs to be the same model as the slave module (i.e. Voltage-Current), and be equipped with the CANbus digital interface (optional on the XDC 6000 Watt series). It also needs the proper firmware version for the control mother board (see page 19).

Features

- Supports up to five XDC units in current sharing configuration (one master and four slaves)
- Front panel with the standard rack mount brackets, handles, ON/OFF switch and two status LEDs (one green for POWER ON and one red for OUTPUT OFF - lit when the output is off)
- Standard CANbus and RS-232 digital remote control
- Auto Addressing in current share initialization
- Digital processing for accurate control
- CE mark, UL and CSA Approvals, FCC compliant

Overview
Front Panel

Front Panel

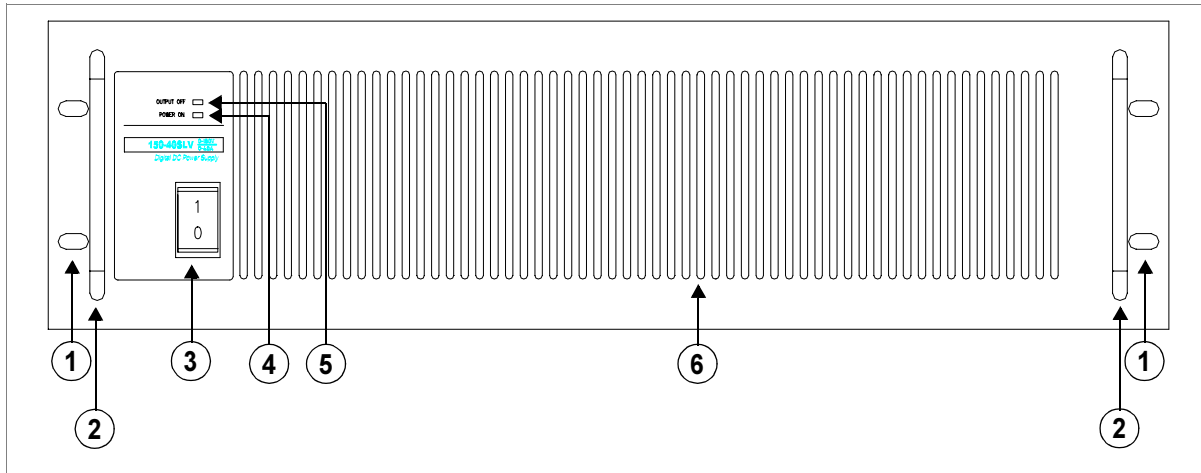

Figure 1.1 Slave Front Panel

1. Rack mount brackets
2. Handles
3. ON/OFF Switch
4. Power On status LED (green)
5. Output Off status LED (red) Lit when the output is disabled
6. Front panel display (vacuum fluorescent display)

Section 2. AC Input Power



WARNING

Disconnect AC power from the unit before removing the connector cover. Live line voltages may be exposed when the cover is removed.



WARNING

A safety ground wire must be connected to the unit as shown in Figure 2.1 to ensure operator safety.



CAUTION

When the power switch is turned on, output voltage or current previously set may be applied to loads, depending on the supply configuration.

AC Input Power
AC Input Connector

AC Input Connector

The AC input connector is a standard wire clamp terminal block with 3-phase connectors and a chassis ground connector. The safety ground wire, alternatively, may be connected to the chassis using a ring tongue on the ground stud as shown in Figure 2.1.

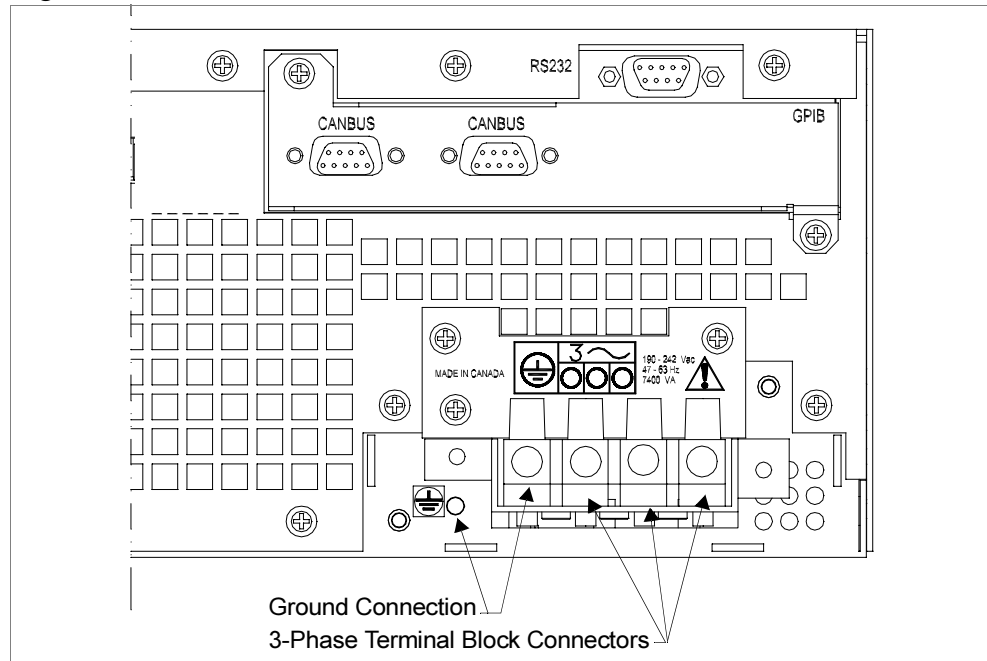

Figure 2.1 AC Input Connector

AC Input Wire

The manufacturer recommends the AC input wire specified in Table 2.1. This must be permanently connected to an approved AC distribution box with suitably rated over-current protection. If you require a special cord, contact the manufacturer.

Table 2.1 AC Wire Specification for 6000 Watt units

AC Input Voltage Range	Wire
190–242Vac, 47–63Hz, 3-phase, 4 wire (standard)	4 x 10 AWG (3 wire plus safety ground), stranded copper, 60°C minimum, 300V, 0.800 in. maximum cable diameter, rated for 25A.
342–500Vac, 47–63Hz, 3-phase, 4 wire (HV-Input)	4 x 14 AWG (3 wire plus safety ground), stranded copper, 60°C minimum, 600V, 0.800 in. maximum cable diameter, rated for 13A.

AC Wire Input Connection

See Figure 2.2, on page 18.

To connect the AC input wires:

1. Ensure that the AC input cord is de-energized, and that the power switch on the front of the power supply is OFF.
2. Strip approximately 6.25 in. (160 mm) from the jacket of the AC wire. Strip 0.55 in. (14 mm) at the end of each wire.
3. Undo the 2 screws for the AC wiring strain relief/cover on the rear panel. Remove the cover.
4. Undo the strain relief screws. Insert the AC input cable through the strain relief until the outer cable jacket is flush with the inside of the strain relief. Tighten the strain relief cable clamp screws.
5. Insert the ground wire (green) 0.55 in. (14 mm) into the left-most terminal location, and tighten securely¹. (The safety ground wire may alternatively be connected to the chassis ground stud next to the terminal block, using a suitably sized ring terminal).
6. Route the AC wires to the input terminal block by connecting the red, black, and white wires to the remaining 3 cable clamp connectors. There is no set order for connecting the wires. Any of the 3-phase wires can be connected to any of the 3 line input connectors. To connect each wire, loosen the terminal screw, insert the stripped wire 0.55 in. (14 mm) into the terminal, and tighten the screw securely¹.
7. Reinstall the AC input strain relief/cover, routing wires inside the cover to prevent pinching.
8. Connect the free end of the cable to the AC source, checking that the voltage is within the approved input range for the supply.
9. Energize the AC input.

It is now safe to turn the power supply on.

-
1. Torque maximum 2 Nm/16 lb. in.

AC Input Power

AC Wire Input Connection

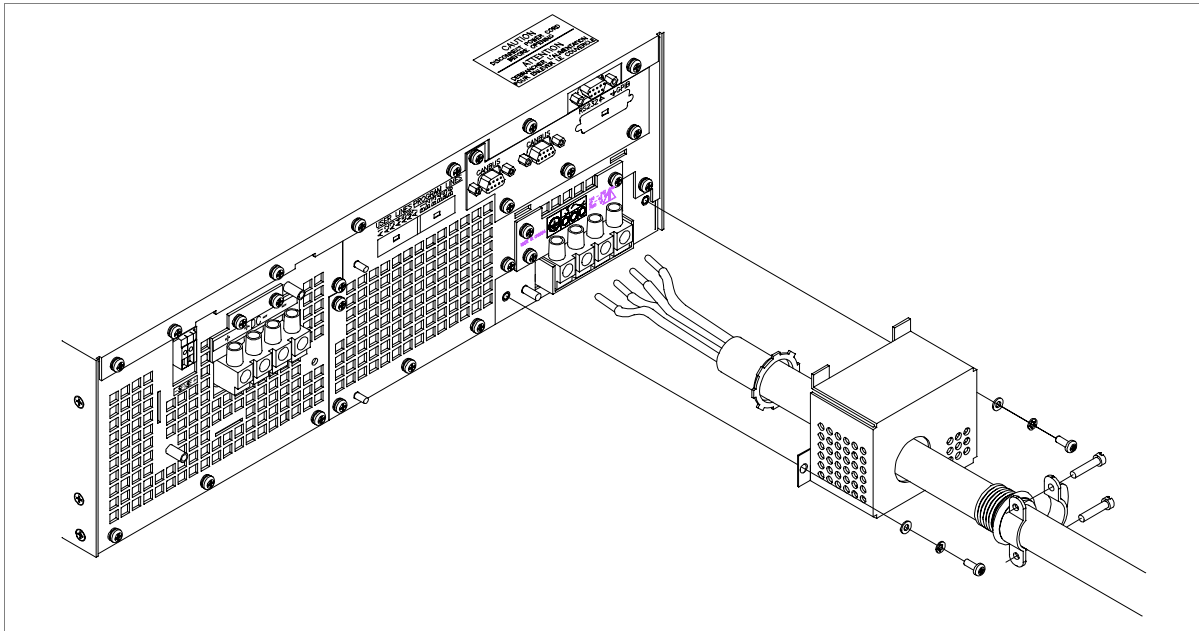

Figure 2.2 Attaching the AC Input Wires

Section 3. Current Sharing

Overview

Power supplies equipped with the CANbus interface will allow current sharing between units connected in parallel. Current sharing can use a maximum of 5 supplies, including the master. All power supplies must be the same model. Every unit must have a unique address, if they do not then they will automatically readdress themselves. The slave units are shipped with the current share feature already enabled.

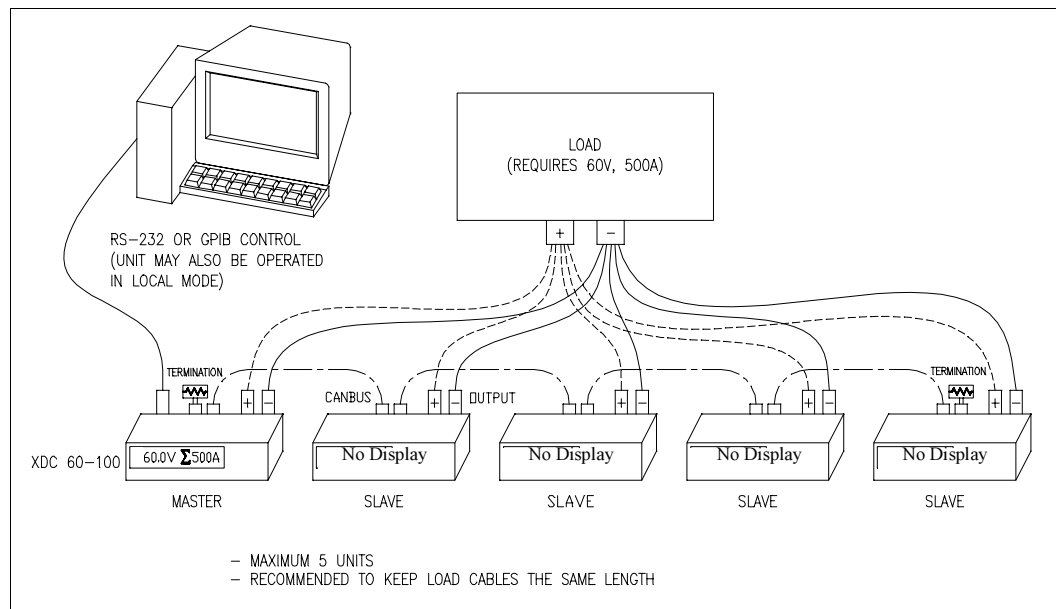

Figure 3.1 Connections for Current Share Operation

Theory of Operation Power supplies may be connected in parallel to supply a large current to a load. Typically, because of differences in the load connections, each power supply may provide different amounts of current to the load. The function of current sharing is to even out the current provided by each power supply.

When multiple power supplies are configured for current sharing, the master supply will make small changes to the slave's voltage and current settings to equalize the current draw from each.

Note: Slave units will not current share with master units with firmware previous to version 5.000.

Current Sharing
Overview

CANbus Setup The CANbus port is a one male, one female DB9 connector to support “daisy chain” connections. The CAN (Controller Area Network) is an ISO standard (ISO11898) for a serial communication network. Table 3.1 describes the pin functions. Pins 1, 4, 8, and 9 are not used. The CANbus is part of the optional GPIB/CANbus interface card, which is required for communication between the master unit and its slave units.

Table 3.1 CANbus Pins

Pin #	Function
1	Not used
2	CANLO
3	Ground
4	Not used
5	Ground
6	Ground
7	CANHI
8	Not used
9	Not used

Setup

1. Connect power supplies to be controlled via the CANbus network. Parallel male DB9 to female DB9 cables (N-1) are required. Each slave unit is shipped with one male-female DB9 8 in. ribbon cable. Connect the CAN interface cards in series, linking the first power supply to the second using one cable, and then the second to the third using a second cable and the second CAN port. A single ribbon cable with multiple connectors may be used instead of several cables for ease of connection. Terminate the bus at both ends with 120 ohm, 1/4 Watt resistors (included) across the CAN HI and CAN LO signals (Pins 2 and 7). See Table 3.1, “CANbus Pins,” on page 20.
2. The master power supply may be connected to a PC via RS-232 or GPIB.
3. Turn the power supplies on one at a time, starting with the master, and check that the green “Power ON” LED on each slave unit is lit. As each slave is turned on, it will automatically configure itself with a sequential unique address. The address is retained in non-volatile memory.

Note: Only the first 4 slave units powered on will current share.

Note: Only units with the same output ratings will current share.

Current Share Configuration Units are programmed in a mode such that it is already in current sharing mode on power up. This feature is not user-modifiable. Please contact the manufacturer for assistance if you wish to change this.

Most configurable settings available on a master 6kW unit are disabled on the slave units for protection. All the queries are still available.

- Setup Current Sharing Network** To set up multiple supplies for current share operation, follow these steps:
1. Power down the units. Connect the CAN ports of all paralleled units as explained in “CANbus Setup”.
 2. Make load connections. It is recommended to keep load cables the same length if possible. See Figure 3.1.
 3. Power up the master.
 4. Power up the slaves one at a time.
 5. Set the voltage and current on the master, then enable the output.

Current Sharing Operation

Operation

There can only be one master unit and 4 slave units current sharing. All other units will not current share. Units must have the same output ratings or they will not current share.

Once a current sharing network is setup, you may adjust the voltage setpoint on the master. The master will automatically adjust the setpoints of the slave units to equalize the current output of all units. You may also disable or enable the output of the master, automatically disabling or enabling the output of all slaves.

When a slave's output is disabled for any reason, the master will disable the entire current sharing network.

You may use local or remote (RS-232, GPIB, multichannel or analog) control to operate the master.

Slaves will be operating under remote control from the master and in local lockout. Hence, they will only respond to remote queries.

The current limit setpoint on the master is still the current limit for a single unit, not the current limit for the entire current sharing network. Please see the operating manual shipped with your master unit (full digital controlled front panel unit).

Power supplies may not enter calibration mode while current sharing, or enter current share operation while in calibration mode. To enter calibration mode, turn off all other units on the CANbus network.

Errors A master or slave will be disabled from current sharing (set to "No share") if:

- there is more than one master connected to the CANbus, (Error +1811)
- there are more than 4 slaves, (Error +1822), or
- the model does not match that of the master's, (Error +1822).

Specifications

Max units on bus	49
Max current share units	5
Max cable length	40m
Bus speed	700 kbits/sec.
Termination	120 ohm, 1/4 Watt
Connections	parallel male DB9 to female DB9 cable

Appendix A. Specifications and Characteristics

Notes

- These specifications are represented over the full operating temperature range.
 - Nominal line input voltage assumed unless otherwise stated.
 - All sense lines are configured for default local operation.
 - All specifications are subject to change without notice.
 - Unless otherwise noted, these specifications are for single units, not multiple configurations.
-

Specifications and Characteristics

Electrical Specifications—Summary

Electrical Specifications—Summary

Table A.1 Specifications for 10V to 60V Models

Models	10-600	20-300	30-200	40-150	60-100
Output Ratings:					
Output Voltage ¹	0–10 V	0–20 V	0–30 V	0–40 V	0–60 V
Output Current ²	0–600 A	0–300 A	0–200 A	0–150 A	0–100 A
Output Power	6000 W	6000 W	6000 W	6000 W	6000 W
Line Regulation: ³					
Voltage (0.01% of Vmax)	1 mV	2 mV	3 mV	4 mV	6 mV
Current (0.05% of Imax)	300 mA	150 mA	100 mA	75 mA	50 mA
Load Regulation: ⁴					
Voltage (0.05% of Vmax + 5 mV)	10 mV	15 mV	20 mV	25 mV	35 mV
Current (0.1% of Imax + 20 mA)	620 mA	320 mA	220 mA	170 mA	120 mA
Output Noise (0–20 MHz):					
Voltage (p–p)	75 mV	75 mV	75 mV	75 mV	100 mV
Output Ripple (rms):					
Voltage	10 mV	10 mV	12 mV	15 mV	15 mV
Current ⁵	3100 mA	1600 mA	1000 mA	750 mA	450 mA
OVP Adjustment Range: (0% to 103% of Vmax)					
	0–10.3 V	0–20.6 V	0–30.9 V	0–41.2 V	0–61.8 V
Efficiency: ⁶					
	0.85	0.87	0.87	0.87	0.89

1. Minimum output voltage is <0.3% of rated voltage at zero output setting.
2. Minimum output current is <0.2% of rated current at zero output setting when measured with rated load resistance.
3. For input voltage variation over the AC input voltage range, with constant rated load.
4. For 0–100% load variation, with constant nominal line voltage.
5. Current mode noise is measured from 10% to 100% of rated output voltage, full current, unit in CC mode.
6. Typical efficiency at nominal input voltage and full output power.

Table A.2 Drift Specifications for 10V to 60V Models

Models	10-600	20-300	30-200	40-150	60-100
Drift (30 minutes): ¹					
Voltage (0.04% of Vmax)	4 mV	8 mV	12 mV	16 mV	24 mV
Current (0.6% of Imax)	3600 mA	1800 mA	1200 mA	900 mA	600 mA
Drift (8 hours): ²					
Voltage (0.02% of Vmax)	2 mV	4 mV	6 mV	8 mV	12 mV
Current (0.04% of Imax)	240 mA	120 mA	80 mA	60 mA	40 mA
Temperature Coefficient: ³					
Voltage (0.04% of Vmax/°C)	4 mV	8 mV	12 mV	16 mV	24 mV
Current (0.06% of Imax/°C)	360 mA	180 mA	120 mA	90 mA	60 mA

1. Maximum drift over 30 minutes with constant line, load, and temperature, after power on.
2. Maximum drift over 8 hours with constant line, load, and temperature, after 30 minute warm-up.
3. Change in output per °C change in ambient temperature, with constant line and load.

Specifications and Characteristics
Electrical Specifications—Summary

Table A.3 Specifications for 80V to 600V Models

Models	80–75	100–60	150–40	300–20	600–10
Output Ratings:					
Output Voltage ¹	0–80 V	0–100 V	0–150 V	0–300 V	0–600 V
Output Current ²	0–75 A	0–60 A	0–40 A	0–20 A	0–10 A
Output Power	6000 W	6000 W	6000 W	6000 W	6000 W
Line Regulation: ³					
Voltage (0.01% of Vmax)	8 mV	10 mV	15 mV	30 mV	60 mV
Current (0.05% of Imax)	37.5 mA	30 mA	20 mA	10 mA	5 mA
Load Regulation: ⁴					
Voltage (0.05% of Vmax + 5 mV)	45 mV	55 mV	80 mV	155 mV	305 mV
Current (0.1% of Imax + 20 mA)	95 mA	80 mA	60 mA	40 mA	30 mA
Output Noise (0–20 MHz):					
Voltage (p–p)	100 mV	100 mV	150 mV	250 mV	350 mV
Output Ripple (rms):					
Voltage	15 mV	20 mV	20 mV	30 mV	80 mV
Current ⁵	320 mA	230 mA	120 mA	50 mA	25 mA
OVP Adjustment Range: (0% to 110% of Vmax)					
	0–88 V	0–110 V	0–165 V	0–330 V	0–660 V
Efficiency: ⁶					
	0.89	0.90	0.90	0.91	0.91

1. Minimum output voltage is <0.3% of rated voltage at zero output setting.
2. Minimum output current is <0.2% of rated current at zero output setting when measured with rated load resistance.
3. For input voltage variation over the AC input voltage range, with constant rated load.
4. For 0–100% load variation, with constant nominal line voltage.
5. Current mode noise is measured from 10% to 100% of rated output voltage, full current, unit in CC mode.
6. Typical efficiency at nominal input voltage and full output power.

Table A.4 Drift Specifications for 80V to 600V Models

Models	80–75	100–60	150–40	300–20	600–10
Drift (30 minutes): ¹					
Voltage (0.04% of Vmax)	32 mV	40 mV	60 mV	120 mV	240 mV
Current (0.6% of Imax)	450 mA	360 mA	240 mA	120 mA	60 mA
Drift (8 hours): ²					
Voltage (0.02% of Vmax)	16 mV	20 mV	30 mV	60 mV	120 mV
Current (0.04% of Imax)	30 mA	24 mA	16 mA	8 mA	4 mA
Temperature Coefficient: ³					
Voltage (0.04% of Vmax/°C)	32 mV	40 mV	60 mV	120 mV	240 mV
Current (0.06% of Imax/°C)	45 mA	36 mA	24 mA	12 mA	6 mA

1. Maximum drift over 30 minutes with constant line, load, and temperature, after power on.
2. Maximum drift over 8 hours with constant line, load, and temperature, after 30 minute warm-up.
3. Change in output per °C change in ambient temperature, with constant line and load.

Specifications and Characteristics

AC Line Input Specifications

AC Line Input Specifications

The input to the power supply requires the following specifications.

AC Line Input Voltage Operating Ranges

Table A.5 AC Line Input Specifications

Operating Range	
nominal 208V _{rms} (Standard)	190 to 242 V _{ac} 3 ϕ (3 wire + safety ground)
nominal 400V _{rms} (with HV-Input option)	342 to 500 V _{ac} 3 ϕ (3 wire + safety ground)
Frequency Range	
	47 to 63 Hz
Maximum Peak In-rush Current at turn on	
	35 A _{rms}
Minimum Power Factor ¹	
nominal 208V _{rms} (Standard)	0.95
nominal 400V _{rms} (with HV-Input option)	0.9
Operating Current	
nominal 208V _{rms} (Standard)	
Maximum ²	24 A
Typical ³	20 A
Operating Current	
nominal 400V _{rms} (with HV-Input option)	
Maximum ⁴	13 A
Typical ⁵	11 A

1. At nominal input voltage and maximum power
2. At 190V_{ac} input voltage, 55°C ambient temperature and maximum power
3. At 208V_{ac} input voltage, 25°C ambient temperature and maximum power
4. At 342V_{ac} input voltage, 50°C ambient temperature and maximum power
5. At 400V_{ac} input voltage, 25°C ambient temperature and maximum power

Output Performance Specifications

These specifications define the electrical performance specifications of the power supply output. These specifications apply to both local and remote sense configurations, except where noted. These specifications apply to all programming sources, except where noted. These specifications are for single units, unless otherwise indicated.

Rated Output Range

Voltage	0–100%
Current	0–100%

Efficiency

- Typical 89% efficiency at nominal line voltage and ambient temperature.
- Minimum 82% efficiency. Specific minimum efficiency limits are model dependent.

Load Regulation

Voltage	5 mV + 0.05% of Vmax
Current	20 mA + 0.1% of Imax
Power	1% of Pmax

Line Regulation

Voltage	0.01% of Vmax
Current	0.05% of Imax
Power	1% of Pmax

Programming Range for Voltage, Current, and Power

Voltage and Current	From 0–103% of the rated maximum output
Power	From 3–103% of the rated maximum output

OVP Programming Range

- 0–103% of maximum rated voltage

Specifications and Characteristics
 Output Performance Specifications

Typical Programming Resolution

Remote Digital Interface	
Voltage	0.002% of Vmax
Current	0.002% of Imax
Power	0.05% of Pmax
Over Voltage Protection	0.002% of Vmax

Typical Measurement Resolution

Remote Digital Interface	
Voltage	0.002% of Vmax
Current	0.002% of Imax
Power	0.05% of Pmax

Programming Accuracy¹

Remote Digital Interface	
Voltage Programming	0.1% of Vmax
Current Programming	0.5% of Imax
Power Programming	0.5% of Pmax
Over voltage Programming	0.1% of Vmax

Readback Accuracy

Remote Digital Interface	
Voltage Readback	0.15% of Vmax
Current Readback	0.5% of Imax
Power Readback	0.5% of Pmax

30 Minute Drift²

Voltage	0.04% of Vmax
Current	0.6% of Imax
Power	1% of Pmax

1. Accuracy specifications apply for settings in range of 1% to 100% of rated output
2. At 25°C ±5°C, with full power load

Specifications and Characteristics
Output Performance Specifications

8 Hour Drift Temperature Stability¹

Voltage	0.02% of Vmax
Current	0.04% of Imax
Power	0.1% of Pmax

Temperature Coefficients

Remote Digital Interface	
Voltage Programming	0.04% of Vmax/°C
Current Programming	0.06% of Imax/°C
Power Programming	0.1% of Pmax/°C
Voltage Readback	0.04% of Vmax/°C
Current Readback	0.06% of Imax/°C
Power Readback	0.1% of Pmax/°C

Switching Frequency

Typical 31 kHz; 62 kHz output ripple

Rise Time

5 to 95% step in output voltage.

Load Condition	Time (Max)
No Load	100 ms
Full Load	100 ms

Fall Time

For a programmed 95% to 5% step in output voltage.

Load Condition	Time (Max)
No Load ¹	3 s
Full Load	50 ms

1. Fall time is ≤ 4s for 300 V and 600 V units.

Time Delay From Power On Until Output Stable

5 s maximum
(Within regulation envelope)

1. At 25°C ±5°C after 30 minutes full load operation

Specifications and Characteristics

Output Performance Specifications

Time Delay From Output Enable Until Output Stable

2 s maximum
(Within regulation envelope)

Output Hold-Up Time – Power Off

Minimum 4 ms (at full load)

Output Hold-Up Time – Source Interruption

Minimum 4 ms with output deviation less than 5% of maximum output voltage after source interruption.

Transient Response Time¹

Time to recover within 0.75% of rated output of previous level after step change in load current between 50% and 100%.

Mode	Time
Voltage Mode	3 ms stand alone unit ¹

1. 96 ms typical in current sharing configuration

Mode Crossover

Maximum deviation as a percentage of rated output voltage.

CV – CC Overshoot	1%
-------------------	----

Peak–Peak and RMS Noise Bandwidth Limits

The frequency range for Peak to Peak measurements is 10 Hz–20 MHz.

The frequency range for RMS measurements is 10 Hz–100 kHz.

Maximum Remote Sense Line Drop Compensation

Minimum 3.8 V for each line, 5 V typical

Isolation

AC Input to Output	1350 V _{ac}
AC Input to Chassis	1350 V _{ac}
Output to Chassis	600 V _{ac}

1. Time for the output voltage to recover within 0.75% of rated output of its previous level after a step change in load current of up to 50% - 100% and 100% to 50% of rated output

Specifications and Characteristics
Environmental Specification

Environmental Specification

Operating Altitude	Up to 6,500 feet (2,000 m)
Storage Altitude	Up to 50,000 feet (15,000 m)
Installation Category	II (IEC 1010-1)
Pollution Degree	2 (IEC 1010-1)

Thermal Specification

Operating Temperature Range	0°C–50°C ¹
Storage Temperature Range	–40°C–+85°C

1. Consult the factory for operation below 0°C and above 50°C.

Humidity Specification

Operating Humidity Range	< 95% RH, Non-condensing
Storage Humidity Range	< 95% RH, Non-condensing

International Approvals

CE-marked units meet: EN61010-1, EN50081-2 and EN500082-2.

CSA C/US certified to C22.2 No 1010.1 and UL3111-1.

Meets USA EMC standard: FCC, part 15, class A.

Meets Canadian EMC standard: ICES-001.

Specifications and Characteristics

Mechanical Specification

Mechanical Specification

Weight Approx. 75 lb. (34 kg) for 10 V-600 A unit, without packaging

Size

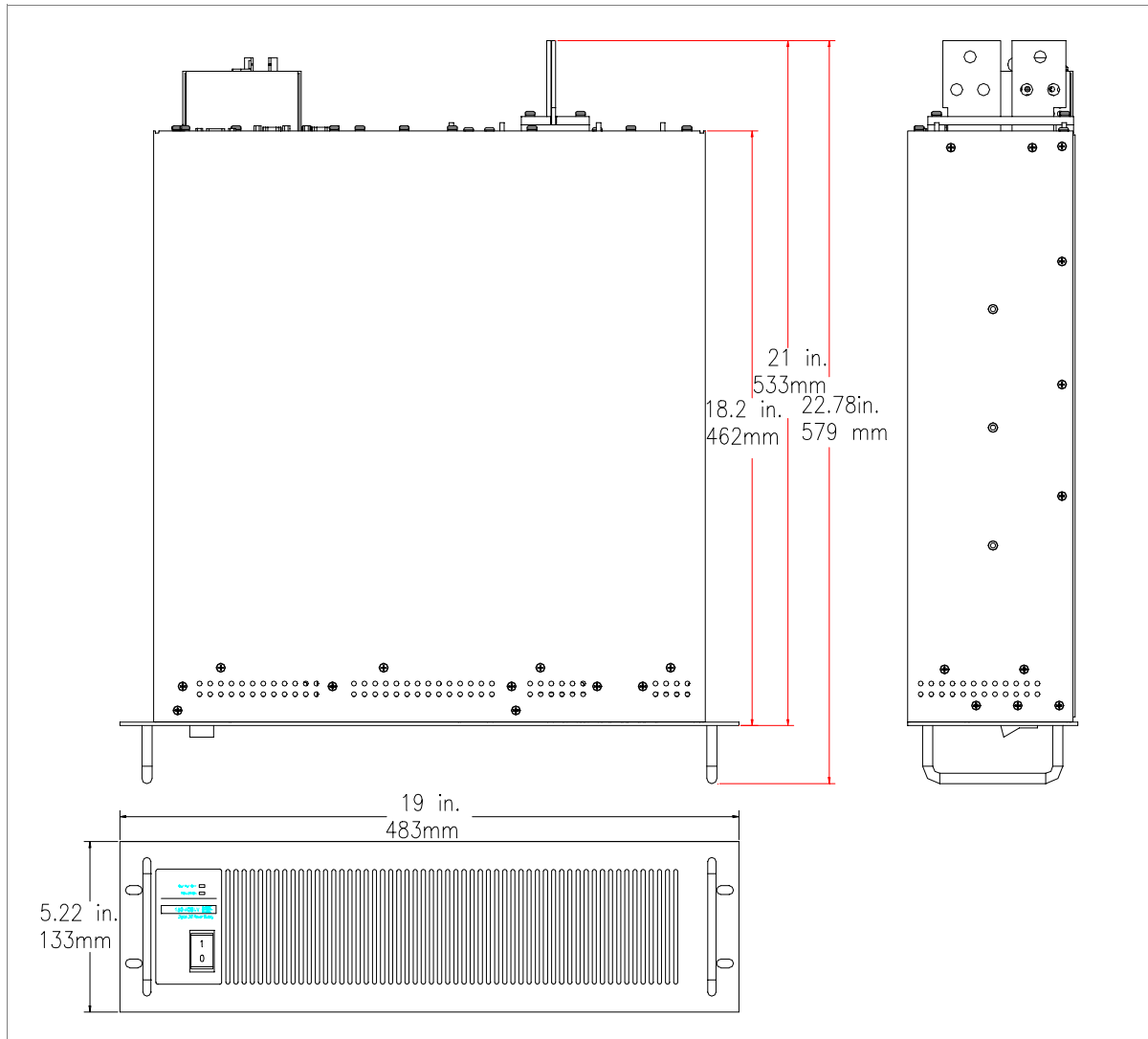
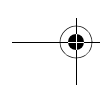
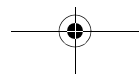
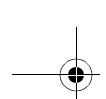

Figure A.1 Power Supply Dimensions



Xantrex Technology Inc.

8999 Nelson Way
Burnaby, British Columbia
Canada V5A 4B5
604 422 2777 Tel
604 420 2145 Fax
800 670 0707 Toll Free North America
customerservice@xantrex.com
www.xantrex.com

TM-XDSL-01XN

PRINTED IN CANADA

Free Manuals Download Website

<http://myh66.com>

<http://usermanuals.us>

<http://www.somanuals.com>

<http://www.4manuals.cc>

<http://www.manual-lib.com>

<http://www.404manual.com>

<http://www.luxmanual.com>

<http://aubethermostatmanual.com>

Golf course search by state

<http://golfingnear.com>

Email search by domain

<http://emailbydomain.com>

Auto manuals search

<http://auto.somanuals.com>

TV manuals search

<http://tv.somanuals.com>