

Smart choice for power

xantrex

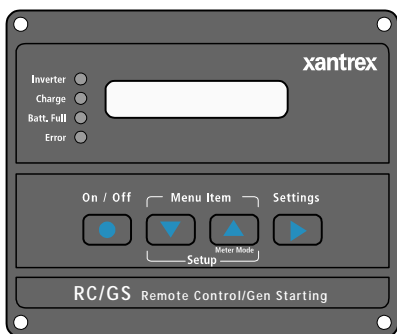

RC/GS
RC7

Owner's Manual

RV Series Remote Control

www.xantrex.com

RV Series Remote Controls

RC/GS, RC7

Owner's Manual

About Xantrex

Xantrex Technology Inc. is a world-leading supplier of advanced power electronics and controls with products from 50 watt mobile units to one MW utility-scale systems for wind, solar, batteries, fuel cells, microturbines, and backup power applications in both grid-connected and stand-alone systems. Xantrex products include inverters, battery chargers, programmable power supplies, and variable speed drives that convert, supply, control, clean, and distribute electrical power.

Trademarks

RV Series Remote Control is a trademark of Xantrex International. Xantrex is a registered trademark of Xantrex International.

Other trademarks, registered trademarks, and product names are the property of their respective owners and are used herein for identification purposes only.

Notice of Copyright

RV Series Remote Control Owner's Manual © June 2005 Xantrex International. All rights reserved.

Disclaimer

UNLESS SPECIFICALLY AGREED TO IN WRITING, XANTREX TECHNOLOGY INC. ("XANTREX")

- (a) MAKES NO WARRANTY AS TO THE ACCURACY, SUFFICIENCY OR SUITABILITY OF ANY TECHNICAL OR OTHER INFORMATION PROVIDED IN ITS MANUALS OR OTHER DOCUMENTATION.
- (b) ASSUMES NO RESPONSIBILITY OR LIABILITY FOR LOSS OR DAMAGE, WHETHER DIRECT, INDIRECT, CONSEQUENTIAL OR INCIDENTAL, WHICH MIGHT ARISE OUT OF THE USE OF SUCH INFORMATION. THE USE OF ANY SUCH INFORMATION WILL BE ENTIRELY AT THE USER'S RISK.

Date and Revision

June 2005 Revision A

Part Number

975-0210-01-01

Contact Information

Telephone: 1 800 670 0707 (toll free North America)
1 360 925 5097 (direct)

Fax: 1 360 925 5143 (direct)

Email: customerservice@xantrex.com

Web: www.xantrex.com

About This Manual

Purpose

The purpose of this Owner's Manual is to provide explanations and procedures for installing and operating the RV Series Remote Controls—RC/GS and RC7.

Scope

The Manual provides safety guidelines, planning and setup information, installation procedures, as well as information about operating the unit. It also contains information about configuring and operating the RV Series Inverter/Charger with the RC/GS or RC7.

Audience

The Manual is intended for anyone who needs to install and operate the RC/GS or RC7. Installers should be certified technicians or electricians.

Organization

This Manual is organized into four chapters.

Chapter 1 contains information about the function and features of the RV Series Remote Controls.

Chapter 2 contains information and procedures to install the RV Series Remote Controls.

Chapter 3 contains information about configuring the RV Series Remote Controls.

Chapter 4 contains information and procedures to operate the RV Series Remote Control.

Conventions Used

The following conventions are used in this guide.



WARNING

Warnings identify conditions or practices that could result in personal injury or loss of life.



CAUTION

Cautions identify conditions or practices that could result in damage to the unit or to other equipment.

Important: These notes describe an important action item or an item that you must pay attention to.

Related Information

You can find more information about Xantrex Technology Inc. as well as its products and services at www.xantrex.com

Important Safety Instructions



WARNING: Save these instructions

This Owner's Manual contains important safety and operating instructions. Before using your RV Series Remote Control, be sure to read, understand, and save these safety instructions.



WARNING: Restrictions on use

The RC/GS or RC7 shall not be used in connection with life support systems or other medical equipment or devices.

General Precautions

1. Before installing and using the RC/GS or RC7, read all appropriate sections of this guide and any cautionary markings on the device and the devices to which it connects.
2. If the product has been damaged, see “Warranty and Return Information” on page 49.
3. Do not dismantle the product; it contains no user serviceable parts. See “Information About Your System” on page 54 for instructions on obtaining service.
4. Protect the product from rain, snow, spray, and water.

Explosive gas precautions



WARNING: Explosion hazard

This equipment is not ignition protected. To prevent fire or explosion, do not install the RC/GS or RC7 in compartments containing flammable materials or in locations that require ignition-protected equipment. This includes any space containing gasoline-powered machinery, fuel tanks, as well as joints, fittings, or other connections between components of the fuel system.

Contents

Important Safety Instructions -----	v
1 Introduction	
Features -----	2
Indicators and Controls -----	4
2 Installation	
Installing the RC/GS and RC7 -----	6
Materials and tools required -----	6
Choosing a location-----	7
Mounting and Connecting -----	7
3 Configuration	
Viewing the Setup Menu -----	12
Changing Settings -----	12
Configuring the RC/GS and RC7 -----	13
Set Idle -----	13
Battery Capacity-----	13
Battery Type -----	14
Max Charge Rate -----	15
Set Shore Power -----	15
Remote Setup-----	16
LCD Contrast-----	16
Set Clock (RC/GS Only) -----	17
Select Genset (RC/GS Only) -----	17
Generator Start (RC/GS Only) -----	18
Generator Stop (RC/GS Only) -----	19
Thermostat Start Enable and Disable (RC/GS Only)-----	20
Begin Gen Quiet and End Gen Quiet (RC/GS Only)-----	21
Saving Setup Choices -----	22

RC/GS and RC7 Setup Menu Summary - - - - - 23
RV Series Inverter/Charger and RC/GS and RC7 Setup - - - 23
Auto Gen Start Setup (RC/GS Only) - - - - - 24

4 Operation

Indicators and Controls - - - - - 26
 Status LEDs - - - - - 26
 Inverter LED - - - - - 27
 Charge LED - - - - - 27
 Batt. Full LED - - - - - 28
 Error LED - - - - - 28
 LCD Screen - - - - - 28
 Buttons - - - - - 29
 On/Off - - - - - 29
 Meter Mode - - - - - 29
System Status Displays - - - - - 30
 AC Source Messages - - - - - 30
 Waiting for AC - - - - - 30
 Genset Status: Pending, Cranking and Restart
 (RC/GS Only) - - - - - 30
 Starter Cooldown and Gen Start (RC/GS Only) - - - - - 31
 Genset Error Messages (RC/GS Only) - - - - - 32
 Gen Won't Start - - - - - 32
 Gen Quiet Fault - - - - - 32
 Inverter Mode Messages - - - - - 34
 Charger Mode Messages - - - - - 35
 Bulk Charging - - - - - 35
 Absorption Charging - - - - - 35
 Float Charging - - - - - 36
 Equalizing Charging - - - - - 36
 Inverter/Charger Error Messages - - - - - 37
 Over Temperature - - - - - 38
 Overload - - - - - 38
 High Battery Voltage - - - - - 39
 Low Battery Voltage - - - - - 39

Charger Fault - - - - -	40
Meters Display - - - - -	41
Average Shunt Amps - - - - -	41
Battery Voltage - - - - -	41
Inverter/Charger Current - - - - -	42
AC Output Voltage - - - - -	42
AC Input Amps - - - - -	42
System Status Messages - - - - -	43
Battery State of Charge - - - - -	43
Set Shore Power - - - - -	44
Generator Start/Stop (RC/GS Only) - - - - -	44
Storage Checklist - - - - -	45
Preparation for Storage - - - - -	45
RC/GS and RC7 User's Menu Summary - - - - -	46
System Status Messages - - - - -	46
Generator Status Messages (RC/GS Only) - - - - -	46
System Status Display - - - - -	47
Meters Display - - - - -	47
Warranty and Return Information - - - - -	49

1

Introduction

Chapter 1 contains information about the function and features of the RV Series Remote Controls.

Topics in this chapter are organized as follows:

- “Features” on page 2
- “Indicators and Controls” on page 4.

Features

The RC/GS and RC7 are control panels that allow remote operation of a RV Series Inverter/Charger.

Features of the RC/GS and RC7 include:

- Simple menu-driven programming for full control of all inverter/charger functions
- A three-level menu to prevent accidental setting changes
- Meters to display voltage and current
- An intelligent battery fuel gauge displaying estimated battery capacity
- Error message and information displays used to optimize system performance
- Remote ON/OFF inverter operation.
- RJ11 phone jack connection to inverter/charger.

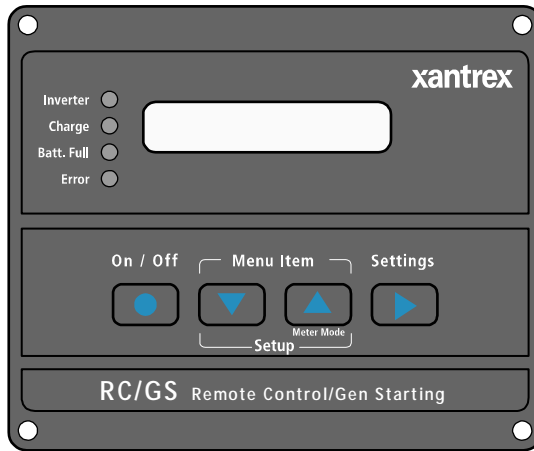

Figure 1-1 RC/GS Front Panel

Connection cable requirements

The RC7 and RC/GS use a telephone-style cord to connect to the RV Series Inverter/Charger (models RV2012GS, RV2012GS-15/20B, RV2012GS-20B, RV2512GS, and RV3012GS).

Use only Xantrex-recommended accessories:

Part number	Cable Length
31-6257-00	25 feet
31-6262-00	50 feet
31-6275-00	70 feet

To connect the RC/GS or RC7 to a non-GS series RV Series Inverter/Charger, use a data-standard RJ11 cable. This cable is sold separately in 25-foot (order #392-9) or 50-foot (order #392-5) lengths.

Note: The RC/GS functions with non-GS series inverter/chargers. However, not all the generator start features of the RC/GS are compatible with non-GS series inverter/chargers.

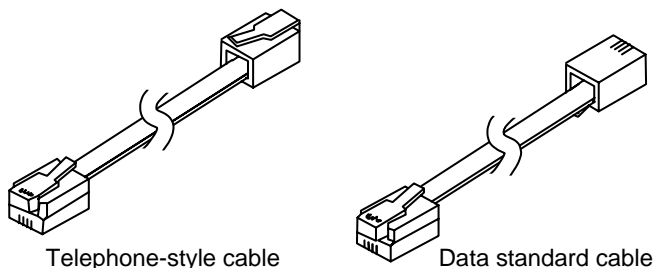

Figure 1-2 Remote Control Cable Types

Indicators and Controls

All operating controls and indicators are located on the front panel of the remote control.

ON/OFF Control The inverter portion of the inverter/charger can be switched OFF or ON using the remote control. The standby charger in the inverter is automatic and always ready and available for charging whenever AC power is applied.

Meters The RC/GS and RC7 feature several meters that monitor the operating conditions of the power center. These meters include: Average Shunt Amps, Battery Voltage, Inverter/Charger Current, AC Output Voltage, AC Input Amps, and Estimated Battery Capacity.

Controls The RC/GS and RC7 allow the inverter to be switched ON or OFF with the press of a button on the remote. The RC/GS and RC7 can be used to configure the inverter/charger to the specific system and preferences including Battery Capacity, Battery Type, Charger Rate, Shorepower Amps, and LCD screen Contrast. In addition, the RC/GS starts and stops the generator automatically or manually, allows the setting of generator make and model, sets a “quiet time” during which the generator will not start automatically, and has manual overrides for auto gen start.

Status Monitoring The RC/GS and RC7 monitor operating conditions, including the AC supply, inverter operation, charger operation, battery condition, and (on the RC/GS only) generator condition.

2 Installation

Chapter 2 contains information and procedures to install the RV Series Remote Controls.

Topic in this chapter are organized as follows:

- “Materials and tools required” on page 6
- “Choosing a location” on page 7
- “Mounting and Connecting” on page 7.

Installing the RC/GS and RC7

The RC/GS and RC7 are designed to be flush mounted through an opening in a wall and secured with four screws.

The RC/GS and RC7 require no connections other than one cable that plugs into the back of the unit. Because you cannot access the cable jack once the unit is mounted, the cable needs to be routed through the wall before securing the remote.

All operating power for the RC/GS and RC7 is provided by the RV Series Inverter/Charger through the cable.



CAUTION

Allow at least 2 ¼ inches (57 mm) of space behind the wall to accommodate the depth of the unit and allow room for the cable to bend.

Materials and tools required

You will need these materials and tools to complete the installation:

- level, measuring tape, and pencil
- four #6 screws and appropriate screwdriver
- jigsaw or small keyhole saw
- power drill with 1/16" bit (optional)
- RC/GS and RC7 remote cable (telephone-style cable if connecting to a GS-series inverter/charger, data-standard cable if connecting to a non-GS series inverter/charger).

Choosing a location

Choose a location that is easily accessible. The RC/GS and RC7 should be mounted where they are clearly visible, with unobstructed access to the screen and buttons.

The location should be indoors, dry, and free from corrosive or explosive fumes.

Mounting and Connecting



WARNING: Fire hazard

The RC/GS and RC7 are not ignition protected. Do not install in areas requiring ignition-protected equipment.



WARNING: Shock hazard

Before making an opening in a wall, bulkhead, or panel, ensure there is no wiring or other obstruction within the wall.

To install the remote:

1. Refer to Figure 2-1 for hole and cutout dimensions or install the remote in a standard double-gang outlet box.
2. Pilot-drill the mounting holes (if necessary, depending on your mounting surface) and, using a jigsaw, cut out the hole in which the remote will be inserted.

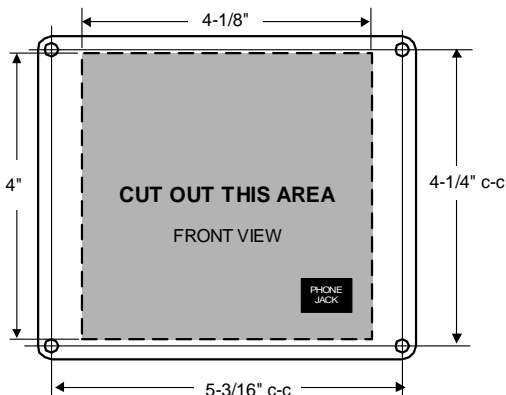

Figure 2-1 Installation Dimensions

3. Run the cable between the remote and the RV Series Inverter/Charger.
4. Place the ON/OFF switch on the RV Series Inverter/Charger to the OFF position and disconnect the AC power.
5. Connect the communications cable into the RJ11 port on the inverter/charger marked “Remote Control” (Figure 2-2).

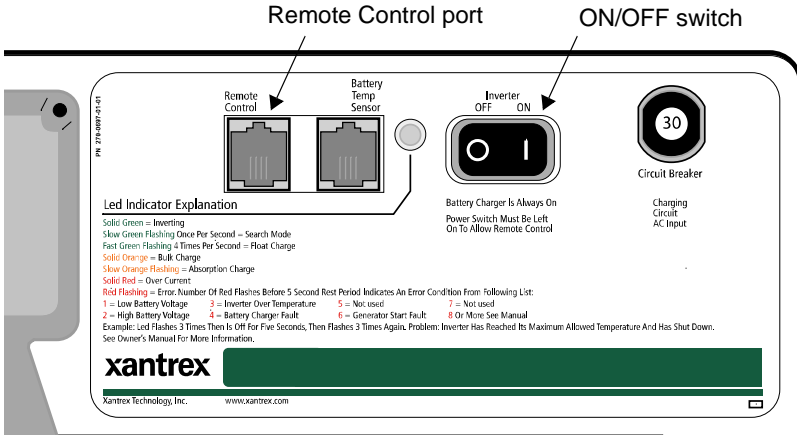

Figure 2-2 RV Series Inverter/Charger Front Panel

6. Connect the other end of the cable into the jack on the remote (Figure 2-3).

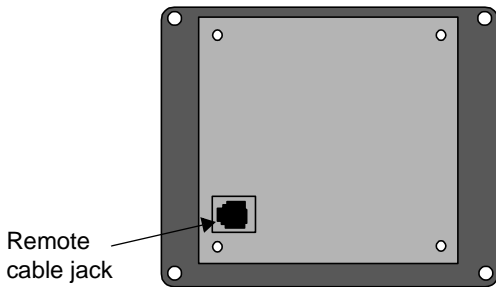

Figure 2-3 RC/GS and RC7 Back View

7. Secure the remote to the wall or outlet box using the appropriate screws (4 required).

8. Wait for the screen to show the message “Waiting for AC.”
9. Place the ON/OFF switch on the RV Series Inverter/Charger to the ON position.

Important: The remote will not operate the RV Series Inverter/Charger if the ON/OFF switch is in the OFF position.

10. Reconnect the RV Series Inverter/Charger to the AC source. After a brief delay, the remote will display a system status message similar to Figure 2-4.

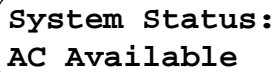

**System Status:
AC Available**

The image shows a rectangular box with rounded corners and a thick black border. Inside the box, the text "System Status:" is on the top line and "AC Available" is on the bottom line, both in a bold, monospaced font.

Figure 2-4 System Status Message

3 Configuration

Chapter 3 contains information about configuring the RV Series Remote Controls.

The topics in this chapter are organized as follows:

- “Viewing the Setup Menu” on page 12
- “Changing Settings” on page 12
- “Configuring the RC/GS and RC7” on page 13
- “RC/GS and RC7 Setup Menu Summary” on page 23.

Viewing the Setup Menu

You can use the RV Series Remote Controls to configure the RV Series Inverter/Charger and the remote itself.

Configuration is performed using the Setup menu. You can view the Setup menu and configure settings by using the Setup/Menu Item buttons and the Settings button.

To view the Setup menu and enter Setup mode, press and hold the two Setup/Menu Item buttons for approximately five seconds, or until the screen clears, then release the buttons.

You can scroll through menu items by pressing the up or down arrow buttons.

To exit Setup mode, press and hold the Setup/Menu Item buttons for approximately five seconds until the screen changes back to the System Status Display.

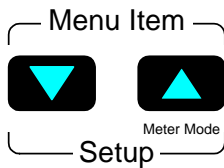

Figure 3-1 Setup/Menu Item Buttons

Changing Settings

You can change settings using the Settings button while in Setup mode. This button scrolls through menu items one at a time. If you pass the desired item or setting, continue pressing the Settings button until the item or setting reappears.

You can also use the Settings button to enable or disable the equalize charge mode.

Settings



Figure 3-2 Settings button

Configuring the RC/GS and RC7

The following menu items appear in the sequence they appear on the RC/GS and RC7. See “RC/GS and RC7 Setup Menu Summary” on page 23 for the complete menu structure.

Set Idle

Set Idle enables or disables the power-saving “search sense” mode feature. Refer to the RV Series Inverter/Charger Owner’s Manual for a complete description of the search sense mode.

To configure Set Idle, use the Settings button to scroll to the desired setting. The default setting is Defeat.

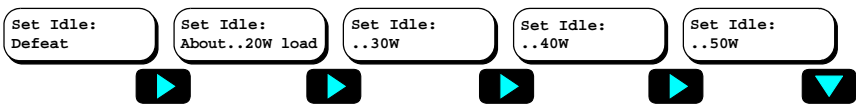

Figure 3-3 Set Idle menu items

Selecting Defeat disables the search sense function. The remaining selections specify the minimum wattage load that must be present on the inverter to qualify as a load and bring the inverter out of the search sense mode and begin inverting. After selecting, press the down arrow to access the next menu.

Battery Capacity

Battery Capacity refers to the battery’s reserve capacity in amp-hours. The RC/GS and RC7 approximate the battery state-of-charge (SOC), then estimate the battery capacity (Auto) over several charge/discharge cycles. However, setting the capacity manually assures a more accurate initial SOC calculation. The default setting is Auto.

The Battery Capacity setting also sets the absorption charge time where the batteries are charged at the bulk voltage.

Table 3-1 Battery Capacity Settings

Setting	Absorption Charge Time
Auto	110 minutes (1.8 hours)
125 A-hrs	60 minutes (1 hour)
250 A-hrs	90 minutes (1.5 hours)
375 A-hrs	120 minutes (2 hours)
500 A-hrs	150 minutes (2.5 hours)
1000 A-hrs	180 minutes (3 hours)

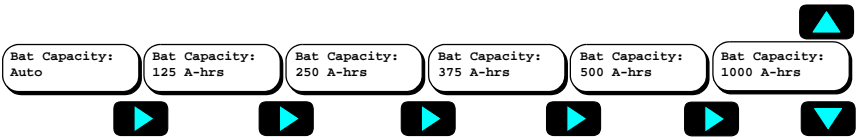

Figure 3-4 Battery Capacity menu items

Battery Type

To ensure the batteries are receiving the proper charge voltage, the Battery Type must be selected for the type of batteries used in the system: GEL Cell, Flooded Lead Acid and AGM. The default setting is GEL Cell.

This voltage varies depending on the batteries used, as specified below.

Table 3-2 Battery Type and Charge Voltage

Battery Type	Bulk VDC	Float VDC	Equalize VDC
GEL Cell	14.1	13.6	Defeated
Flooded Lead Acid	14.6	13.4	15.5
AGM	14.4	13.4	15.5

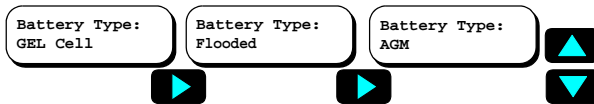

Figure 3-5 Battery Type menu items

Max Charge Rate

The battery charger's maximum output current can be specified using the Max Charge Rate menu. The default is 100% of the maximum charge rate. Refer to the RV Series Inverter/Charger Owner's Manual for model-specific adjustable charge rates in amps.

Maximum	Minimum	Default	Step Size
100%	10%	100%	10%

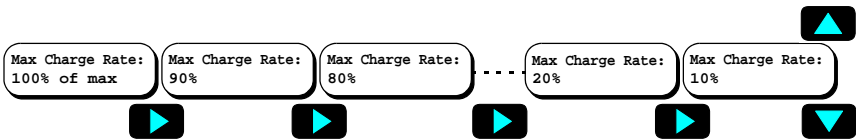

Figure 3-6 Max Charge Rate menu items

Set Shore Power

The inverter monitors the AC power being drawn by both the battery charger and the AC loads connected to the inverter. If the current draw approaches the shorepower circuit breaker rating, the battery charger reduces the amount of current supplied to the batteries to provide the maximum current to the AC loads. Set Shore Power ensures the battery charger does not exceed the shorepower circuit breaker rating. This setting should match the shorepower or generator's circuit breaker rating. The default setting is 30 amps (and above).

Note: The maximum current draw from the RV3012GS charger is 28 amps.

Note: This setting does not prevent the loads from exceeding the shore circuit breaker rating.

Maximum	Minimum	Default	Step Size
30 A or more	5 Amps	30 Amps	5 Amps

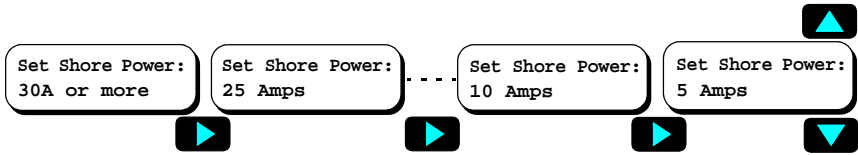

Figure 3-7 Set Shore Power menu items

Remote Setup

The Remote Setup screen displays system status and error messages that occur during normal operation. From the Setup menu you can select:

- Last Key (default) to display the last system status message displayed after exiting the Setup menu.
- Rolling Display to automatically show system status, state-of-charge, time left to run, time left to charge, set shore power and gen start/stop (RC/GS only).
- Power Saver to shut off the screen and LEDs after five minutes without a button press or new error message. Pressing any key will reactivate the screen and LEDs for another five minutes. Errors during the power saver mode will “wake up” the remote.



Figure 3-8 Remote Setup menu items

LCD Contrast

You can use the LCD Contrast menu to adjust the screen contrast to accommodate changing lighting conditions and viewing angle. The default setting is Maximum Contrast.

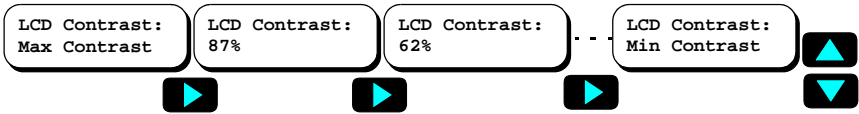

Figure 3-9 LCD Contrast menu items

Set Clock (RC/GS Only)

Some RC/GS automatic generator start functions are based on the time of day. The clock must be properly set to ensure the programmed function will perform at the correct time. The clock uses 24-hour time and ranges from 00:00 to 23:59. To access the Set Clk menu, scroll down past the generator menus by pressing the down arrow. A flashing cursor appears below (and behind) the hour (H) or minute (M) characters in the screen. Every eight seconds the cursor alternates positions. When the cursor is under the hour digit, press the Settings button to set the hours to the current hour (00 to 23). When the cursor is under the minutes digit, press the Settings button to set the minutes to the current minute (0 to 59). Press and hold the Settings button to quickly increase the selected value, or press and release to increase the value by one unit at a time.

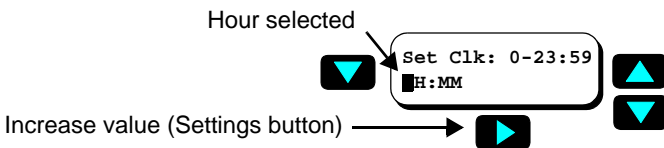

Figure 3-10 Set Clock display

Select Genset (RC/GS Only)

After setting the clock, press the up arrow once to access the Select Genset menu. Select the type and model of the generator by pressing the Settings button until the generator's name and model is displayed. The default is Onan QuietDiesel.

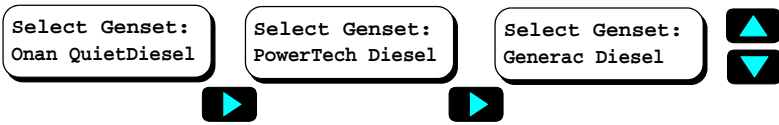

Figure 3-11 Select Genset menu items

Generator Start (RC/GS Only)

After setting the clock and selecting a generator, set the parameters for automatically starting the generator based upon a battery voltage. Press the up arrow and scroll through the menus to view the Generator Start menu. Press the Settings button to select the required setting.

Note: You cannot set the Auto Gen parameters until you set the clock.

Note: When the battery voltage drops to the selected generator start setting, there is a 15-minute delay before the generator starts. If the battery voltage rises above the generator start setting during that 15-minute delay, the countdown resets itself and the generator does not start.

The default Generator Start selection is Manual (Push ON). This setting disables all automatic start functions. Any other selection from the Generator Start menu enables the RV Series Inverter/Charger to automatically start the generator based upon the battery's voltage.

The available auto start voltage settings are 11.0, 11.5, 11.8, 12.0, and 12.2 VDC.

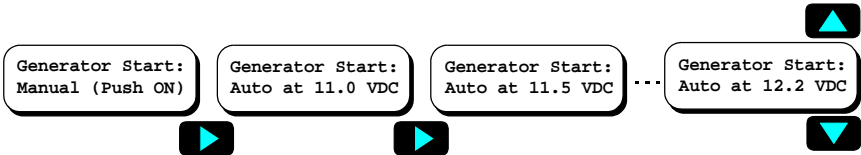

Figure 3-12 Generator Start menu items

The generator can be started or stopped at any time by pressing the down arrow button until the Gen Start/Stop menu is displayed. Press and hold the On/Off button until you hear a beep from the RC/GS. Release the button after the beep sounds.

If the inverter/charger senses an AC supply and the battery voltage is below the automatic start setting, the generator does not start. When you start the generator with the On/Off button, the generator starts even if an AC supply is present.

Important: If the generator is manually started from the remote, a manual override is initiated and the generator will not stop automatically. Shut down the generator manually.



Figure 3-13 Generator Start/Stop

Generator Stop (RC/GS Only)

The RC/GS can be configured so that the RV Series Inverter/Charger stops the generator automatically when the charger initiates the Absorption or the Float mode of charging. Refer to the RV Series Inverter/Charger Owner's Manual for a detailed description of charging modes. The default is Manual (Push Off).

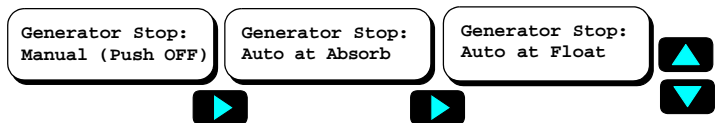

Figure 3-14 Generator Stop menu items

The generator can be stopped at any time by accessing the user menu until the “Gen Start/Stop: Press (On/Off)” menu is displayed. Press and hold the On/Off button until you hear a beep from the RC/GS. Release the button after the beep sounds.

Note: Manually stopping the generator will set the Generator Start selection to Manual (Push On), disabling any automatic start settings. The generator will no longer automatically start after it is manually stopped with the RC/GS.



Figure 3-15 Generator Start/Stop (on Generator Start menu)

Thermostat Start Enable and Disable (RC/GS Only)

The RC/GS can be configured to enable the RV Series Inverter/Charger to start and stop the generator in response to a signal from a thermostat. The RV Series Inverter/Charger must have its Automatic Generator Start connections wired to a thermostat. For more information, see the Installation chapter in the RV Series Inverter/Charger Owner’s Manual.

Enabling this setting allows the generator to automatically power an air conditioner or heater after receiving a signal from a thermostat. Each generator start and stop has a time delay of 30 seconds after the RV Series Inverter/Charger receives the thermostat signal.

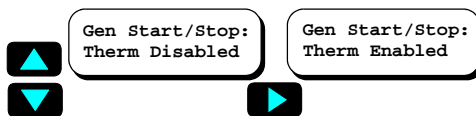

Figure 3-16 Begin Generator Quiet Time display

Begin Gen Quiet and End Gen Quiet (RC/GS Only)

The period of time during which the generator is prevented from starting automatically can be defined using the RC/GS.

To specify the begin quiet time, scroll to the Begin Gen Quiet: 00:00 by using the Up and Down arrow buttons. Set the Begin Gen Quiet start time. The selected digit for hours or minutes will be underlined and highlighted (to set the time, see “Set Clock (RC/GS Only)” on page 17).

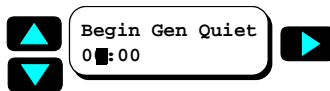

Figure 3-17 Begin Generator Quiet Time display

Press the Down arrow to access the End Gen Quiet: 00:00 menu and select the appropriate end time.

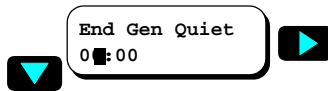

Figure 3-18 End Generator Quiet Time display

Note: Setting Begin Gen Quiet and End Gen Quiet to the same time defeats the quiet time mode.

Note: If the generator is running when quiet time begins, it shuts down automatically. The buzzer also sounds and the screen shows the message “Gen Quiet Fault.” If the auto-start condition still exists at the end of quiet time, the generator will start.

Saving Setup Choices

Once the setup options are complete, press and hold the Setup/Menu Item buttons (see Figure 3-19) for approximately five seconds or until the screen clears. The setup choices will be saved in the inverter/charger's non-volatile memory 20 seconds after exiting the Setup menu if no other actions are taken. These settings will be preserved until changed.

Note: The generator start and stop settings will not be saved if the RC/GS is disconnected or DC power is lost.

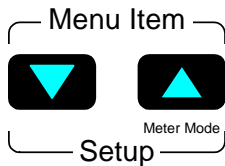

Figure 3-19 Setup/Menu Item Buttons

RC/GS and RC7 Setup Menu Summary

RV Series Inverter/Charger and RC/GS and RC7 Setup



Set Idle: Defeat	Set Idle: About..20W load	Set Idle: ...30W	Set Idle: ...40W	Set Idle: 50W	
---------------------	------------------------------	---------------------	---------------------	------------------	--



Bat Capacity: Auto	Bat Capacity: 125 A-hrs	Bat Capacity: 250 A-hrs	Bat Capacity: 375 A-hrs	Bat Capacity: 500 A-hrs	Bat Capacity: 1000 A-hrs
-----------------------	----------------------------	----------------------------	----------------------------	----------------------------	-----------------------------



Battery Type: GEL Cell	Battery Type: Flooded Lead Acid	Battery Type: AGM	
---------------------------	------------------------------------	----------------------	--



Max Charge Rate: 100% of max	Max Charge Rate: 90%	Max Charge Rate: 80%	- - - - - ▶	Max Charge Rate: 20%	Max Charge Rate: 10%
---------------------------------	-------------------------	-------------------------	-------------	-------------------------	-------------------------



Set Shore Power: 30 A or more	Set Shore Power: 25 Amps	Set Shore Power: 20 Amps	Set Shore Power: 15 Amps	Set Shore Power: 10 Amps	Set Shore Power: 5 Amps
----------------------------------	-----------------------------	-----------------------------	-----------------------------	-----------------------------	----------------------------



Remote Setup: Last Key	Remote Setup: Power Saver	Remote Setup: Rolling Display	
---------------------------	------------------------------	----------------------------------	--



LCD Contrast: Max Contrast	LCD Contrast: 87%	LCD Contrast: 62%	- - - - - - - - - - - ▶	LCD Contrast: Min Contrast
-------------------------------	----------------------	----------------------	-------------------------	-------------------------------



Auto Gen Start Setup (RC/GS Only)



	Generator Start: Manual (Push ON)	Generator Start: Auto at 11.0 VDC	Generator Start: Auto at 11.5 VDC	Generator Start: Auto at 11.8 VDC	Generator Start: Auto at 12.0 VDC	Generator Start: Auto at 12.2 VDC
	Generator Stop: Manual (Push OFF)	Generator Stop: Auto at Absorb	Generator Stop: Auto at Float			
	Gen Start/Stop: Therm Disabled	Gen Start/Stop: Therm Enabled				
	Begin Gen Quiet: 00:00					
	End Gen Quiet: 00:00					
	Select Genset: Onan QuietDiesel	Select Genset: PowerTech Diesel	Select Genset: Generac Diesel			
	Set Clk:0-23:59 00:00					



4 Operation

Chapter 4 contains information and procedures to operate the RV Series Remote Control.

The topics in this chapter are organized as follows:

- “Indicators and Controls” on page 26
- “System Status Displays” on page 30
- “Storage Checklist” on page 45
- “RC/GS and RC7 User’s Menu Summary” on page 46

Indicators and Controls

The RC/GS and RC7 feature LEDs, a display screen, and buttons for viewing operating status.

Status LEDs

Four indicator lights (LEDs) light up or flash during operation to indicate the system's status. When the inverter is powered on, all LEDs flash as the unit goes through a self-test. After the self-test completes, the LEDs indicate the current state of the inverter and charger. Use these LEDs along with the screen to view complete system status.

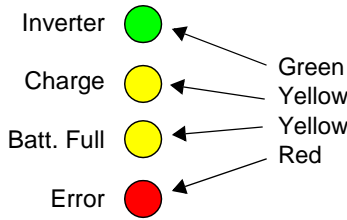

Figure 4-1 Status LEDs

Inverter LED

The green Inverter LED indicates the inverter is on and ready to provide power from the batteries. If AC power is connected to the inverter/charger, the LED flashes. When no AC power is connected, the inverter LED is on solid, indicating that the inverter/charger is inverting (providing power from the batteries). The Inverter LED also indicates inverter status under conditions when the inverter/charger is not inverting.

Inverter LED	Other LEDs or Devices	Meaning
ON (solid)		Inverter on
Flashing	Yellow Charge LED (flashing)	Inverter ready (charging)
Slow flash		Search sense mode
Flashing	Error LED ON and buzzer sounding	Inverter error
OFF		Inverter off

Charge LED

The yellow Charge LED indicates the current battery charge mode.

Charge LED	Other LEDs or Devices	Meaning
ON (solid)		Bulk charging
Slow flash		Absorption charging
Fast flash	Yellow Batt. Full LED ON	Float charging
Very fast flash		Equalize charging
OFF		No charging

Batt. Full LED

The yellow Batt. Full LED indicates the state of charge on the batteries. This LED will not illuminate until the batteries have charged up to at least 90% (according to the inverter/charger’s estimate). The duration of the LED’s on time will increase until the batteries reach 100%, at which time the LED will be on solid. In the inverter mode, the off time duration of the LED will increase until the batteries discharge to below 90%, at which time the LED will turn off.

Batt. Full LED	Other LEDs or Devices	Meaning
Solid		Battery fully charged (100%)
Flashing	Yellow charge LED (flashing)	Battery charged 90% or higher
OFF		Battery below 90% charge

Error LED

The Error LED indicates that there is a problem with the inverter/charger, batteries or generator. Check the LCD screen to find and correct the nature of the problem. For more information, see “Genset Error Messages (RC/GS Only)” on page 32 and “Inverter/Charger Error Messages” on page 37.

Error	Other LEDs or Devices	Meaning
ON (Solid)		Check system

LCD Screen

The screen is used for setting up the system operation as well as viewing current status or error messages. It has two 16-character lines and a backlight. You can scroll through the screen items by using the buttons below the screen.

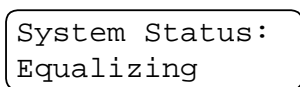

Figure 4-2 LCD screen

Buttons

There are four buttons on the front panel of the RC/GS and RC7 used to control the inverter and enter system operating parameters.

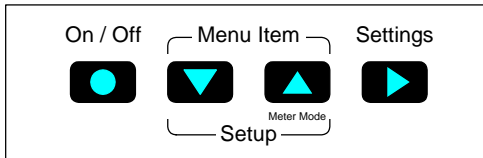

Figure 4-3 Button Controls

On/Off

The On/Off button controls the inverter section of the inverter/charger. Press this button once to turn the inverter on or off. The charger section of the inverter is not affected by this function and maintains the batteries whenever AC power is present. Use this control when you do not want the inverter to supply backup power in the event of an AC line failure. If the inverter is off, AC output power is available only as long as the AC line is present. On the RC/GS, the On/Off button also controls the generator. See “Generator Start/Stop (RC/GS Only)” on page 44.

Note: The inverter is in a ready state when AC utility power is connected and the green Inverter LED is flashing. Pressing the On/Off button while the green LED is on solid (indicating inverter mode) will cause the loss of the inverter output.

Meter Mode

The Meter Mode button accesses the various operating parameters such as output voltage, amperage, temperature, etc. To access the Meter Mode, press and hold the Meter Mode button for approximately five seconds. See “Meters Display” on page 41.

System Status Displays

The RC/GS and RC7 remote controls display the operating mode and system status by lighting one or more LEDs and/or by displaying a message on the screen. The four LEDs reflect the same information as the single tricolored LED on the RV Series Inverter/Charger.

There are four types of system messages:

- AC source messages
- Inverter messages
- Charger messages
- Error messages.

AC Source Messages

AC source messages appear when alternating current (shore power) is present. In addition, the AC source messages describe the current activity, if any, of the generator (RC/GS only).

Waiting for AC

When the inverter is off and AC is not present, the screen displays “Waiting for AC.”

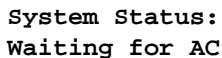

System Status:
Waiting for AC

Genset Status: Pending, Cranking and Restart (RC/GS Only)

When the RC/GS is set up to start the generator for a specified condition (battery voltage or thermostat signal) and that condition has been met, the screen shows “Pending Genstart.”

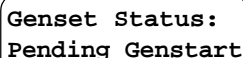

Genset Status:
Pending Genstart

When the initiating condition (battery voltage or thermostat signal) has occurred, the Pending Genstart message is displayed for approximately two minutes, awaiting a change in the condition or a manual override. If neither condition occurs, the inverter/charger attempts to start the generator and the RC/GS displays “Cranking Genset.”

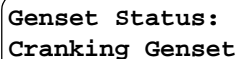
A rectangular box with rounded corners and a black border containing the text "Genset Status: Cranking Genset".

**Genset Status:
Cranking Genset**

Once the generator starts, there is a brief delay to allow the generator to reach operating speed and for the inverter/charger to synchronize to the generator, at which point the screen shows that AC is again available.

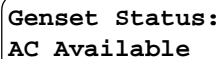
A rectangular box with rounded corners and a black border containing the text "Genset Status: AC Available".

**Genset Status:
AC Available**

Starter Cooldown and Gen Start (RC/GS Only)

If the generator does not start within 60 seconds, a two-minute starter cooldown message is displayed after which another attempt to start the generator occurs.¹ The RC/GS will make a total of three start attempts.

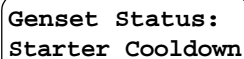
A rectangular box with rounded corners and a black border containing the text "Genset Status: Starter Cooldown".

**Genset Status:
Starter Cooldown**

¹.These are maximum times. They vary according to the Genset you have selected.

Genset Error Messages (RC/GS Only)

Gen Won't Start

If the generator does not start after the three attempts, the RC/GS displays the message “Gen won’t Start” and the red Error LED on the front panel lights. After displaying this message, the RC/GS automatically sets the Generator Start menu to “Manual (Push ON)” and no further attempts to start the generator will occur. Correct the starting problem and set the RC/GS back to the previous auto-start menu.

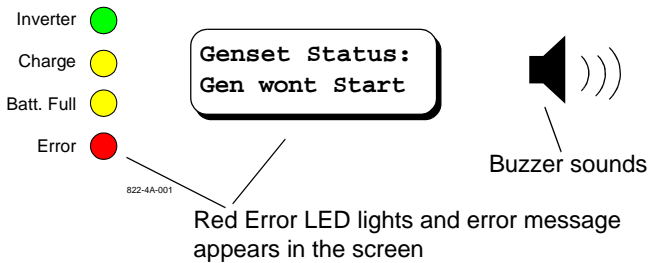

Figure 4-4 Gen Won't Start Error Message

Note: Press any arrow button to cancel the buzzer.

Gen Quiet Fault

If the generator has started in response to an auto start setting and is running when quiet time begins, it shuts down automatically. The buzzer also sounds and the screen shows the message “Gen Quiet Fault” and the red Error LED comes on. The remote control also emits a series of beeping sounds for up to five minutes (press any arrow button on the RC/GS to stop the alarm). If the auto-start condition still exists at the end of quiet time, the generator will start. The gen quiet period can be overridden by setting the Gen Quiet Begin and Gen Quiet End time to the same time.

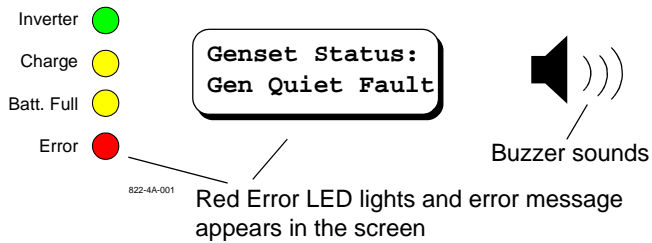

Figure 4-5 Gen Quiet Fault Error Message

Note: If the generator is manually started from the RC/GS, the generator will not shut down automatically. “Man Stop Only” (Figure 4-6) is displayed. Shut down the generator manually. See “Generator Start/Stop (RC/GS Only)” on page 44.

Note: The Gen Quiet Fault error is not actually a system error or fault but rather an alert that the generator has stopped because of quiet time and an auto-start condition still exists.

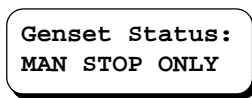

Figure 4-6 Manual Stop Only Message

The Gen Quiet Fault error is automatically reset at the end of the quiet time period if no other action is taken.

Inverter Mode Messages

When the inverter is on (no AC present), it is either inverting or searching the AC output circuits for a load meeting the specifications set up in the Set Idle menu selection (see Figure 3-3 on page 13), if the search sense mode is selected. When the inverter is in the search sense mode, “Searching” appears in the screen and the Inverter LED will slowly flash.

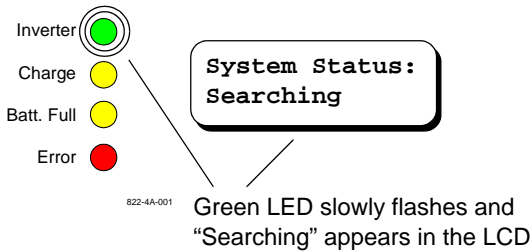

Figure 4-7 Inverter in Search Mode

When the inverter/charger is in the inverter mode (no AC available), “Inverting” appears in the screen and the green Inverter LED is on solid.

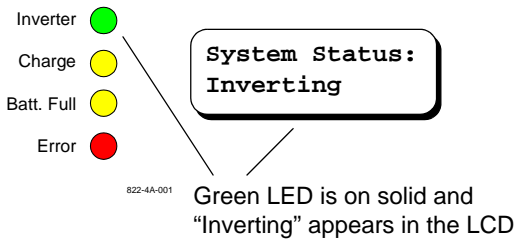

Figure 4-8 Inverter Mode

Note: The Inverter LED flashes during the charge mode if the inverter is switched on. The Inverter LED turns off if the inverter is switched off.

Charger Mode Messages

When AC (shore power or generator power) is available, the inverter/charger automatically switches to the charger mode. There are four separate charger modes: Bulk, Absorption, Float and Equalization. Refer to the inverter/charger Owner's Manual for details on charger modes.

Bulk Charging

When the charger is charging in the Bulk mode, the screen displays "Bulk Charging" and the charge LED is on solid.

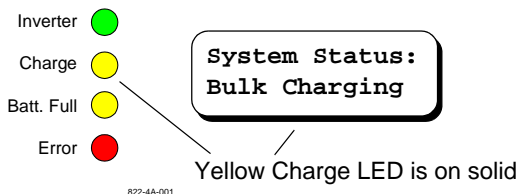

Figure 4-9 Bulk Charging Mode

Absorption Charging

When the charger is charging in the Absorption mode, the screen shows "Absorption Chg" and the Charge LED slowly flashes. In addition, the Batt. Full LED will start to flash when the battery reaches 90% state-of-charge (SOC) according to the inverter/charger's estimate. The on duration of this LED increases as the battery SOC increases, and is on solid at 100% SOC.

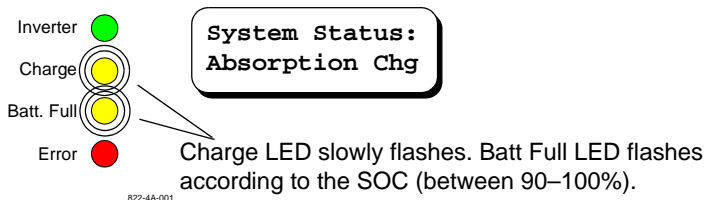

Figure 4-10 Absorption Charging Mode

Float Charging

When the charger is in the Float mode, the screen shows “Float Charging” and the Charge LED quickly flashes. At this point the batteries are fully charged (100%) and the Batt. Full LED is on solid.

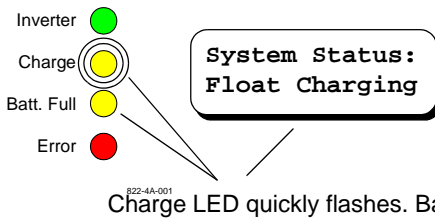

Figure 4-11 Float Charging Mode

Equalizing Charging

To activate the Equalize mode, press and hold the Settings button (right arrow) until the screen clears and “Equalizing” appears (approximately 6 seconds). The Charge LED will increase its flashing rate to approximately 8 flashes per second (flickering). The Equalize charge will continue for 3 hours and then automatically change back to Float.

To cancel Equalize mode, press and hold the Settings button for approximately 6 seconds. If Equalization is cancelled, the screen will indicate the System Status as Absorption chg for approximately 30 seconds before returning to Float charging.



CAUTION

Equalizing the batteries should only be done when the batteries are fully charged (i.e., from Float mode) and only on flooded lead acid or AGM batteries. Vent caps on batteries (lead acid only) should be removed prior to running the Equalize mode.

**CAUTION**

Only flooded lead acid or AGM batteries should be equalize charged. Running an equalize charge on batteries other than flooded lead acid or AGM types could permanently damage them.

**CAUTION**

Do not attempt to remove vent caps on AGM batteries. Doing so may void the warranty.

**CAUTION**

All DC loads should be disconnected during the equalize charge period due to the higher voltage (more than 15 volts DC) applied to the batteries.

Note: The equalizing mode is defeated if GEL cell is selected as the battery type.

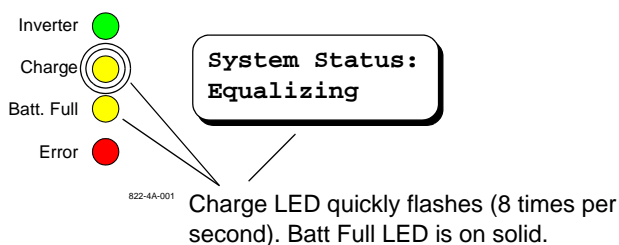

Figure 4-12 Equalizing Mode

Inverter/Charger Error Messages

Error messages appear when a fault is detected with either the inverter or charger. The red Error LED lights, and the buzzer sounds. Error messages for the inverter/charger display the error condition as well as a suggested remedy.

Over Temperature

The “Otemp/Less Load” System Status message indicates the inverter/charger transformer and power components have exceeded a safe operating temperature. Reduce the load on the inverter. When the unit cools, it automatically resets and resumes operation. If this condition occurs often, make sure the inverter is in a cool location, has adequate ventilation, and the cooling fan is operational.

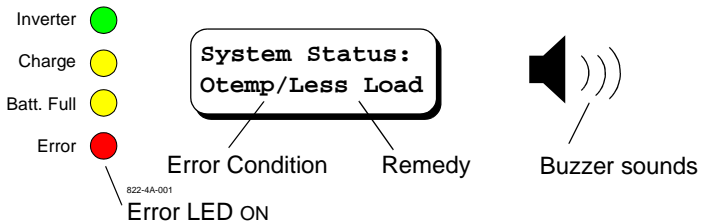

Figure 4-13 Over-temperature Error Message

Note: Press any arrow button to cancel the buzzer.

Overload

The “Overload” System Status message appears when the load on the inverter/charger exceeds the maximum power rating of the unit. Reduce the load and restart the inverter/charger by pressing the On/Off button on the RC/GS and RC7 twice.

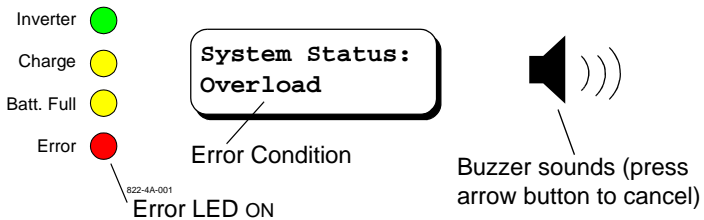

Figure 4-14 Overload Error Message

High Battery Voltage

The “Hibat/Stop Chrg” System Status message appears when the battery voltage rises above 15.7 V. This condition usually occurs only when a charging source other than the RV Series Inverter/Charger is used to charge the battery bank. Switch off any charging sources other than the RV Series Inverter/Charger to allow the voltage level to drop. The inverter automatically resets and resumes operation when the battery voltage falls below 15.4 V.

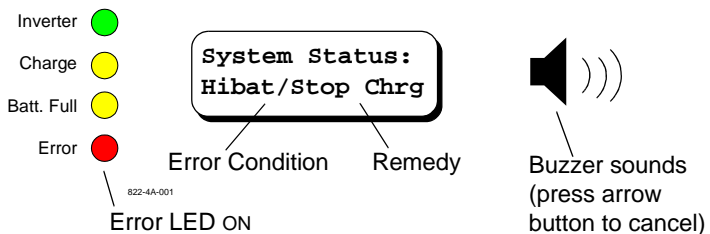

Figure 4-15 High Battery Voltage Error Message

Low Battery Voltage

The “Lobat/Start Chrg” System Status message appears when the battery voltage drops below 10.5 volts. The red Error LED illuminates and the buzzer sounds. The inverter shuts off to prevent damage to the batteries. Provide an AC supply (such as shore power or a generator) to the inverter/charger to automatically start charging the batteries.

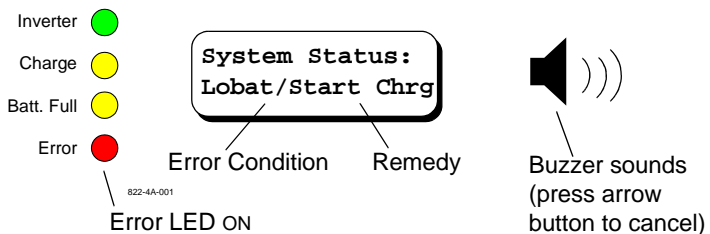

Figure 4-16 Low Battery Voltage Error Message

Charger Fault

The “Charger Fault” System Status message appears when an internal error is detected in the inverter/charger during charging. In addition, the red Error LED is on and the buzzer sounds. After 15 minutes, the charge relay disconnects and the inverter section shuts down. The screen shows “System Status: Overload.”

This fault indicates a hardware failure in the charger circuitry of the inverter/charger. If this message appears, contact Xantrex or the nearest Service Center.

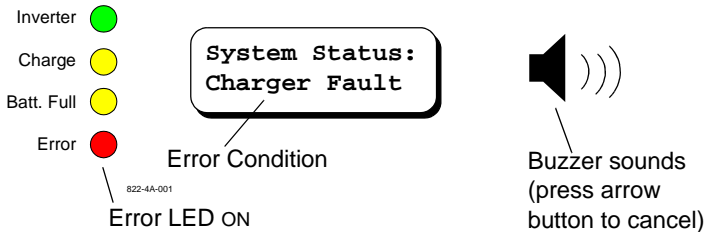

Figure 4-17 Charger Fault Error Message

Meters Display

The RC/GS and RC7 have built-in meters that monitor inverter/charger activities. To view these meters, press and hold the Meter Mode button (up arrow) for five seconds until the screen clears. Use the down arrow button to scroll through the meter displays. The information contained in these displays can be useful for troubleshooting the system.

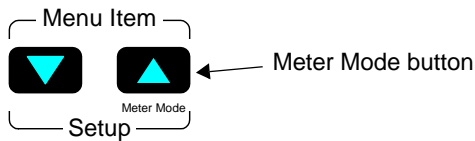
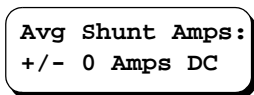

Figure 4-18 Meter Mode Button

Average Shunt Amps

This meter displays the averaged current flowing through the internal shunt to and from the batteries. The inverter/charger must be wired correctly for the internal shunt to work (see the RV Series Inverter/Charger Owner's Manual for more information). If more than one inverter/charger is used, an external shunt connected in the main line between the battery negative and the green inverter chassis ground terminal is required.



Battery Voltage

This meter displays the current battery voltage level. Use this meter to check the condition of the batteries or monitor the levels under load.

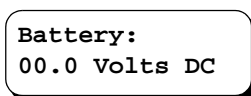

Inverter/Charger Current

This meter displays the actual DC current supplied to the batteries when the RV Series Inverter/Charger is charging (+) and current drawn from the batteries when the inverter/charger is inverting (-).

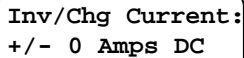

Inv/Chg Current:
+/- 0 Amps DC

AC Output Voltage

This meter displays the actual inverter AC output voltage measured at the AC output. When in the charger mode (or when the inverter is off), the meter will read “0 VAC.” When the inverter is on, “< 40 VAC” appears if Set Idle is set to anything other than “Defeat.”

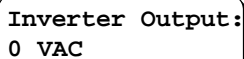

Inverter Output:
0 VAC

AC Input Amps

This meter displays the actual AC current (in amps) flowing through the inverter’s AC input hot 1 terminal when an AC source is connected.

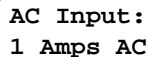

AC Input:
1 Amps AC

System Status Messages

After installing the RC/GS and RC7, the LCD screen displays operating system status messages which is the default screen after exiting all other setting or meter functions. Operating parameters include Battery State-of-charge and Set Shorepower. The Gen Start-Stop switch is also available from these displays.

Press the down arrow to scroll through each display. When the last menu item is reached, the screen returns to the first menu item.

Battery State of Charge

This meter displays a bar graph representing the estimated state-of-charge (SOC) of the battery or battery bank. The SOC is based on the estimated battery capacity. Since discharging the batteries to less than one half of their amp-hour capacity may damage the batteries, the meter estimates the 0% SOC and protects the batteries from over discharge.

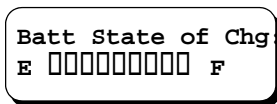

Set Shore Power

This display has the same function as “Set Shore Power” on page 15. You can set the shore power input (from 5 to 30 amps) so the total current draw from the charger does not exceed the circuit breaker rating, to provide the maximum current to the AC loads. Use the Settings button to change this setting to match the circuit breaker rating of the AC power source.

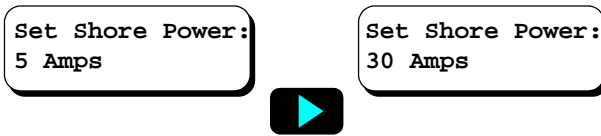

Generator Start/Stop (RC/GS Only)

The generator can be manually started or stopped from this display by pressing the On/Off button on the RC/GS front panel.

Note: Starting the generator from this display overrides all auto-start/stop function and displays “MAN STOP ONLY” on the User Status menu. Manually stopping the generator sets the Generator Start setting to Manual (Push On), disabling any automatic start settings.

On / Off



Gen Start/Stop:
Press (ON/OFF)

Storage Checklist

Proper storage procedures extend the life of the batteries and ensure that your vehicle's power system is ready for operation when needed. The following checklist is for battery-related storage activities.

Preparation for Storage

- Check that all batteries are fully charged.
- Disable the Auto Gen Start feature (RC/GS only).
- Configure the RV to the correct shore service settings.
- Connect the shore power cord to a live outlet (confirm it is live).
- Switch the RV Series Inverter/Charger off using the remote On/Off button (charger only mode).
- Switch off all unnecessary AC and DC loads.



WARNING

Never store your vehicle indoors with the Auto Gen Start feature enabled. The generator produces dangerous fumes when it is running.

RC/GS and RC7 User's Menu Summary

System Status Messages

AC Source	Inverter Mode	Charger Mode	Error Mode
System Status: Waiting for AC	System Status: Searching	System Status: Bulk Charging	System Status: Otemp/Less Load
System Status: AC Available	System Status: Inverting	System Status: Absorption Chrg	System Status: Overload
		System Status: Float Charging	System Status: Hi Bat/Stop Chrg
		System Status: Equalizing	System Status: Lo Bat/Start Chrg
			System Status: Charger Fault

Generator Status Messages (RC/GS Only)

AC Source	Inverter Mode	Charger Mode	Error Mode
Genset Status: Pending Genstart	Genset Status: MAN STOP ONLY		Genset Status: Gen Wont Start
Genset Status: Pending Gen Stop			Genset Status: Gen Quiet Fault
Genset Status: Cranking Genset			
Genset Status: Starter Cooldown			

System Status Display

Batt State of Charge: E ----- F	
Set Shore Power: x.x Amps	
Gen Start/Stop: Press (ON/OFF)*	*RC/GS only

Meters Display

Avg Shunt Amps: +/- 0 Amps DC
Battery: 00.0 Volts DC
Inv/Chg Current: +/- 0 Amps DC
Inverter Output: VAC 0
AC Input: 0 Amps AC

Warranty and Return Information

Warranty

What does this warranty cover? This Limited Warranty is provided by Xantrex Technology Inc. ("Xantrex") and covers defects in workmanship and materials in your RC7 or RC/GS Remote Control. This warranty period lasts for 36 months from the date of purchase at the point of sale to you, the original end user customer. You require proof of purchase to make warranty claims.

This Limited Warranty is transferable to subsequent owners but only for the unexpired portion of the Warranty Period. Subsequent owners also require proof of purchase.

What will Xantrex do? Xantrex will, at its option, repair or replace the defective product free of charge, provided that you notify Xantrex of the product defect within the Warranty Period, and provided that Xantrex through inspection establishes the existence of such a defect and that it is covered by this Limited Warranty.

Xantrex will, at its option, use new and/or reconditioned parts in performing warranty repair and building replacement products. Xantrex reserves the right to use parts or products of original or improved design in the repair or replacement. If Xantrex repairs or replaces a product, its warranty continues for the remaining portion of the original Warranty Period or 90 days from the date of the return shipment to the customer, whichever is greater. All replaced products and all parts removed from repaired products become the property of Xantrex.

Xantrex covers both parts and labor necessary to repair the product, and return shipment to the customer via a Xantrex-selected non-expedited surface freight within the contiguous United States and Canada. Alaska and Hawaii are excluded. Contact Xantrex Customer Service for details on freight policy for return shipments outside of the contiguous United States and Canada.

How do you get service? If your product requires troubleshooting or warranty service, contact your merchant. If you are unable to contact your merchant, or the merchant is unable to provide service, contact Xantrex directly at:

Telephone: 1 800 670 0707 (toll free North America)

1 360 925 5097 (direct)

Fax: 1 360 925 5143 (direct)

Email: customerservice@xantrex.com

Direct returns may be performed according to the Xantrex Return Material Authorization Policy described in your product manual. For some products, Xantrex maintains a network of regional Authorized Service Centers. Call Xantrex or check our website to see if your product can be repaired at one of these facilities.

What proof of purchase is required? In any warranty claim, dated proof of purchase must accompany the product and the product must not have been disassembled or modified without prior written authorization by Xantrex.

Proof of purchase may be in any one of the following forms:

- The dated purchase receipt from the original purchase of the product at point of sale to the end user, or
- The dated dealer invoice or purchase receipt showing original equipment manufacturer (OEM) status, or
- The dated invoice or purchase receipt showing the product exchanged under warranty

What does this warranty not cover? This Limited Warranty does not cover normal wear and tear of the product or costs related to the removal, installation, or troubleshooting of the customer's electrical systems. This warranty does not apply to and Xantrex will not be responsible for any defect in or damage to:

- a) the product if it has been misused, neglected, improperly installed, physically damaged or altered, either internally or externally, or damaged from improper use or use in an unsuitable environment;
- b) the product if it has been subjected to fire, water, generalized corrosion, biological infestations, or input voltage that creates operating conditions beyond the maximum or minimum limits listed in the Xantrex product specifications including high input voltage from generators and lightning strikes;
- c) the product if repairs have been done to it other than by Xantrex or its authorized service centers (hereafter "ASCs");
- d) the product if it is used as a component part of a product expressly warranted by another manufacturer;
- e) the product if its original identification (trade-mark, serial number) markings have been defaced, altered, or removed.

Disclaimer

Product

THIS LIMITED WARRANTY IS THE SOLE AND EXCLUSIVE WARRANTY PROVIDED BY XANTREX IN CONNECTION WITH YOUR XANTREX PRODUCT AND IS, WHERE PERMITTED BY LAW, IN LIEU OF ALL OTHER WARRANTIES, CONDITIONS, GUARANTEES, REPRESENTATIONS, OBLIGATIONS AND LIABILITIES, EXPRESS OR IMPLIED, STATUTORY OR OTHERWISE IN CONNECTION WITH THE PRODUCT, HOWEVER ARISING (WHETHER BY CONTRACT, TORT, NEGLIGENCE, PRINCIPLES OF MANUFACTURER'S LIABILITY, OPERATION OF LAW, CONDUCT, STATEMENT OR OTHERWISE), INCLUDING WITHOUT RESTRICTION ANY IMPLIED WARRANTY OR CONDITION OF QUALITY, MERCHANTABILITY OR FITNESS FOR A PARTICULAR PURPOSE. ANY IMPLIED WARRANTY OF MERCHANTABILITY OR FITNESS FOR A PARTICULAR PURPOSE TO THE EXTENT REQUIRED UNDER APPLICABLE LAW TO APPLY TO THE PRODUCT SHALL BE LIMITED IN DURATION TO THE PERIOD STIPULATED UNDER THIS LIMITED WARRANTY.

IN NO EVENT WILL XANTREX BE LIABLE FOR ANY SPECIAL, INDIRECT, INCIDENTAL OR CONSEQUENTIAL DAMAGES, LOSSES, COSTS OR EXPENSES HOWEVER ARISING WHETHER IN CONTRACT OR TORT INCLUDING WITHOUT RESTRICTION ANY ECONOMIC LOSSES OF ANY KIND, ANY LOSS OR DAMAGE TO PROPERTY, ANY PERSONAL INJURY, ANY DAMAGE OR INJURY ARISING FROM OR AS A RESULT OF MISUSE OR ABUSE, OR THE INCORRECT INSTALLATION, INTEGRATION OR OPERATION OF THE PRODUCT.

Exclusions

If this product is a consumer product, federal law does not allow an exclusion of implied warranties. To the extent you are entitled to implied warranties under federal law, to the extent permitted by applicable law they are limited to the duration of this Limited Warranty. Some states and provinces do not allow limitations or exclusions on implied warranties or on the duration of an implied warranty or on the limitation or exclusion of incidental or consequential damages, so the above limitation(s) or exclusion(s) may not apply to you. This Limited Warranty gives you specific legal rights. You may have other rights which may vary from state to state or province to province.

Warning: Limitations On Use

Please refer to your product manual for limitations on uses of the product.

SPECIFICALLY, PLEASE NOTE THAT THE RC7 AND RC/GS REMOTE CONTROL SHOULD NOT BE USED IN CONNECTION WITH LIFE SUPPORT SYSTEMS OR OTHER MEDICAL EQUIPMENT OR DEVICES. WITHOUT LIMITING THE GENERALITY OF THE FOREGOING, XANTREX MAKES NO REPRESENTATIONS OR WARRANTIES REGARDING THE USE OF THE XANTREX RC7 AND RC/GS REMOTE CONTROL IN CONNECTION WITH LIFE SUPPORT SYSTEMS OR OTHER MEDICAL EQUIPMENT OR DEVICES.

Return Material Authorization Policy

Before returning a product directly to Xantrex you must obtain a Return Material Authorization (RMA) number and the correct factory "Ship To" address. Products must also be shipped prepaid. Product shipments will be refused and returned at your expense if they are unauthorized, returned without an RMA number clearly marked on the outside of the shipping box, if they are shipped collect, or if they are shipped to the wrong location.

When you contact Xantrex to obtain service, please have your instruction manual ready for reference and be prepared to supply:

- The serial number of your product
- Information about the installation and use of the unit
- Information about the failure and/or reason for the return
- A copy of your dated proof of purchase

Record these details in "Information About Your System" on page 54.

Return Procedure

1. Package the unit safely, preferably using the original box and packing materials. Please ensure that your product is shipped fully insured in the original packaging or equivalent. This warranty will not apply where the product is damaged due to improper packaging.
2. Include the following:
 - The RMA number supplied by Xantrex Technology Inc. clearly marked on the outside of the box.
 - A return address where the unit can be shipped. Post office boxes are not acceptable.
 - A contact telephone number where you can be reached during work hours.
 - A brief description of the problem.
3. Ship the unit prepaid to the address provided by your Xantrex customer service representative.

If you are returning a product from outside of the USA or Canada In addition to the above, you **MUST** include return freight funds and are fully responsible for all documents, duties, tariffs, and deposits.

If you are returning a product to a Xantrex Authorized Service Center (ASC) A Xantrex return material authorization (RMA) number is not required. However, you must contact the ASC prior to returning the product or presenting the unit to verify any return procedures that may apply to that particular facility.

Out of Warranty Service

If the warranty period for your RC7 or RC/GS Remote Control has expired, if the unit was damaged by misuse or incorrect installation, if other conditions of the warranty have not been met, or if no dated proof of purchase is available, your unit may be serviced or replaced for a flat fee.

To return your RC7 or RC/GS Remote Control for out of warranty service, contact Xantrex Customer Service for a Return Material Authorization (RMA) number and follow the other steps outlined in “Return Procedure” on page 52.

Payment options such as credit card or money order will be explained by the Customer Service Representative. In cases where the minimum flat fee does not apply, as with incomplete units or units with excessive damage, an additional fee will be charged. If applicable, you will be contacted by Customer Service once your unit has been received.

Information About Your System

As soon as you open your RC/GS Remote Control package, record the following information and be sure to keep your proof of purchase.

- Serial Number _____
- Purchased From _____
- Purchase Date _____

If you need to contact Customer Service, please record the following details before calling. This information will help our representatives give you better service.

- Type of installation [e.g. RV, truck, vehicle, home] _____
- Length of time remote and inverter have been installed _____
- Battery/battery bank size _____
- DC wiring size and length _____
- Warning, Error or Panel Fault Message _____
- Appliances operating when problem occurred _____
- Description of problem _____

Xantrex Technology Inc.

1 800 670 0707 Tel toll free NA

1 360 925 5097 Tel direct

1 360 925 5143 Fax direct

customerservice@xantrex.com

www.xantrex.com

975-0210-01-01

Printed in China

Free Manuals Download Website

<http://myh66.com>

<http://usermanuals.us>

<http://www.somanuals.com>

<http://www.4manuals.cc>

<http://www.manual-lib.com>

<http://www.404manual.com>

<http://www.luxmanual.com>

<http://aubethermostatmanual.com>

Golf course search by state

<http://golfingnear.com>

Email search by domain

<http://emailbydomain.com>

Auto manuals search

<http://auto.somanuals.com>

TV manuals search

<http://tv.somanuals.com>