

# xB

# 2010

## QUICK REFERENCE GUIDE

GET INFORMED.  
ROLL.



what moves you

# 2010 Scion xB

This *Quick Reference Guide* is a summary of basic vehicle operations. It contains brief descriptions of fundamental operations so you can locate and use the vehicle's main equipment quickly and easily.

The *Quick Reference Guide* is not intended as a substitute for the *Owner's Manual* located in the vehicle's glove box. We strongly encourage you to review the *Owner's Manual* and supplementary manuals so you will have a better understanding of the vehicle's capabilities and limitations.

Your dealership and the entire staff of Toyota Motor Sales, U.S.A., Inc. wish you many years of satisfied driving in your new Scion xB.

## **! A word about safe vehicle operations**

This *Quick Reference Guide* is not a full description of Scion xB operations. Every Scion xB owner should review the *Owner's Manual* that accompanies this vehicle.

Pay special attention to the boxed information highlighted in color throughout the *Owner's Manual*. Each box contains safe operating instructions to help you avoid injury or equipment malfunction.

All information in this *Quick Reference Guide* is current at the time of printing. Toyota reserves the right to make changes at any time without notice.

# INDEX

## OVERVIEW

Engine maintenance	7
Fuel tank door release and cap	7
Hood release	6
Indicator symbols	5
Instrument cluster	4
Instrument panel	2-3
<b>Keyless entry<sup>1</sup></b>	<b>6</b>
Light control-Instrument panel	6

## FEATURES/OPERATIONS

Air Conditioning/Heating	12
<b>Auto lock functions<sup>2</sup></b>	<b>8</b>
Automatic Transmission	8
Bottle holders	14
Cruise control	11
Lights & turn signals	10
Multi-information display	15
Parking brake	8
Power outlet	14
Seat adjustments-Front	9
Seat-Folding down rear seat	9
Seats-Head restraints	9
Steering wheel switches	13
Tilt steering wheel	12
USB/AUX audio jack	13
Windows	11
Window wipers & washers	10

## SAFETY AND

## EMERGENCY FEATURES

Door locks	16
Doors-Child safety locks	16
Seatbelts	16
Seat belts-Shoulder belt anchor	16
Spare tire & tools	17
Tire Pressure Monitoring (warning) System	17

<sup>1</sup> Visit your Scion dealer for information on customizing this feature.

<sup>2</sup> Programmable by customer. Refer to the Owner's Manual for instructions and more information.

# OVERVIEW

## Instrument panel

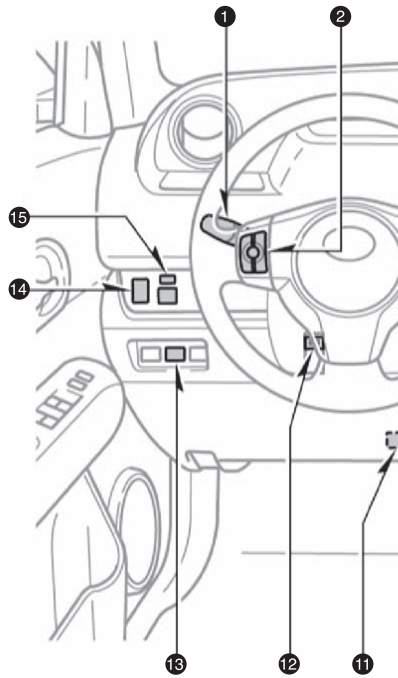

- ① Headlight and turn signal controls
- ② Steering wheel audio controls\*
- ③ Wiper and washer controls
- ④ Rear window defogger button
- ⑤ Air Conditioning controls
- ⑥ Front passenger occupant classification indicator/  
Front passenger seatbelt reminder light
- ⑦ Power outlet
- ⑧ Emergency flasher button

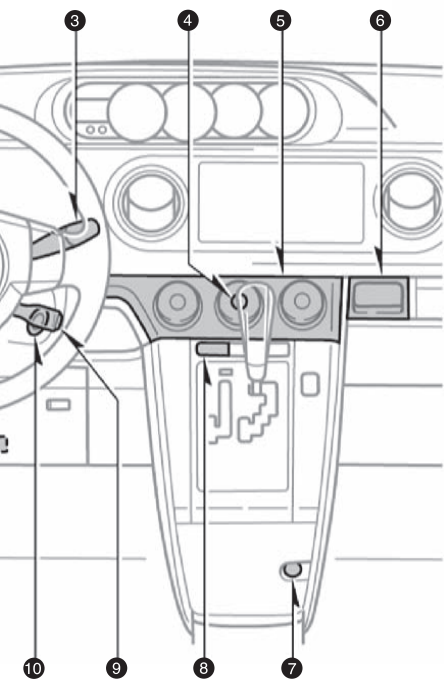

- 9 Cruise control
- 10 Ignition switch
- 11 Tire Pressure Monitoring (warning) System reset
- 12 Tilt steering lock release
- 13 "VSC OFF" (Vehicle Stability Control "OFF")
- 14 Instrument panel light control dial
- 15 Power outside rearview mirror controls





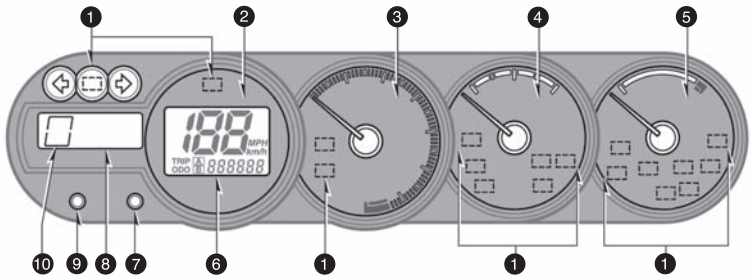















\* For details, refer to the *SCION Audio System Owner's Manual* or *SCION Navigation System Owner's Manual*.

## Instrument cluster



- ① Service indicator and reminder
- ② Speedometer
- ③ Tachometer
- ④ Fuel gauge
- ⑤ Engine coolant temperature
- ⑥ Odometer and two trip meters
- ⑦ Trip meter reset knob
- ⑧ Multi-information display
- ⑨ Multi-information display control switch
- ⑩ Automatic Transmission shift position indicator

## Indicator symbols

	Brake system warning <sup>1</sup>
	Driver seatbelt reminder <sup>1</sup> (alarm will sound if speed is over 12 mph)
	Front passenger seatbelt reminder <sup>1</sup> (alarm will sound if speed is over 12 mph)
	Charging system warning <sup>1</sup>
	Malfunction/Check Engine indicator <sup>1</sup>
	Low engine oil pressure warning <sup>1</sup>
	Open door warning <sup>1</sup>
	Airbag SRS warning <sup>1</sup>
	Low Tire Pressure Warning <sup>1</sup>
	Engine oil replacement reminder <sup>1</sup>
	Front passenger occupant classification indicator
	Headlight low beam indicator
	Headlight high beam indicator
	Turn signal indicator
	Low fuel level warning <sup>1</sup>
	Slip indicator
	Vehicle Stability Control OFF indicator <sup>1</sup>
	Cruise control indicator <sup>2</sup>
	Electric power steering system warning <sup>1</sup>
	Anti-lock Brake System warning <sup>1</sup>

<sup>1</sup> For details, refer to "Service reminder indicators and warning buzzers," Section 1-6, 2010 Owner's Manual.

<sup>2</sup> If this light flashes, refer to "Cruise control," Section 1-7, 2010 Owner's Manual.  
Download from [www.Somanuals.com](http://www.Somanuals.com). All Manuals Search And Download.

## Keyless entry

### Locking operation

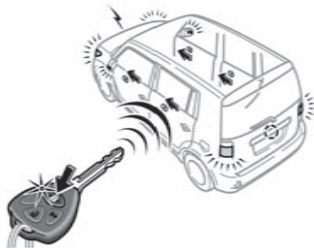

Push



### Unlocking operation

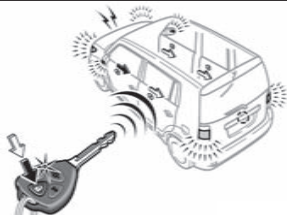

Push ONCE: Driver door  
TWICE: ALL doors



**NOTE:** If a door is not opened within 60 seconds of unlocking, all doors will relock for safety.

### Panic button



Push and hold



## Hood release

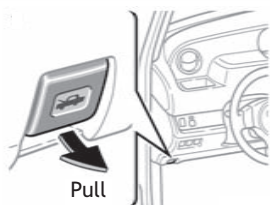

Pull

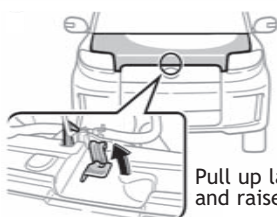

Pull up latch  
and raise hood

## Light control-Instrument panel

Bright

Dark





## Fuel tank door release and cap

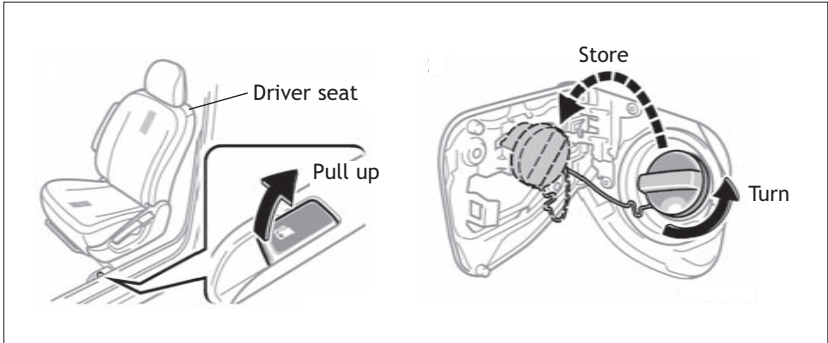

**NOTE:** Tighten until one click is heard. If the cap is not tightened enough, Check Engine “” indicator may illuminate.

## Engine maintenance

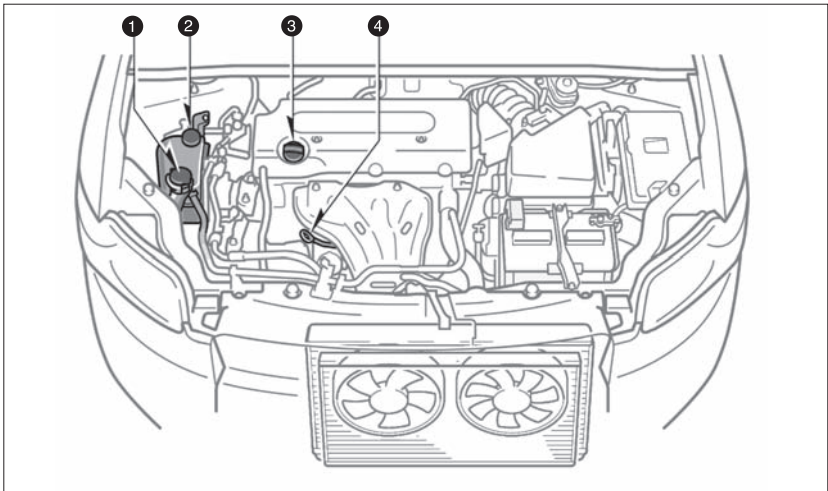

- ① Windshield washer fluid tank
- ② Engine coolant reservoir
- ③ Engine oil filler cap
- ④ Engine oil level dipstick

**Note:** Regularly scheduled maintenance, including oil changes, will help extend the life of your vehicle and maintain performance. Please refer to the “Owner’s Warranty Information Booklet,” “Scheduled Maintenance Guide” or “Owner’s Manual Supplement.”

# FEATURES/OPERATIONS

## Auto lock functions

Automatic door locks can be programmed to operate in four different modes, or turned OFF.

- Doors lock when shifting from Park.\*
- Doors lock when the vehicle speed goes above approximately 12 mph.
- Doors unlock when ignition key is turned to "ACC" or "LOCK" position and driver's door is opened.
- Doors unlock when shifting into Park.\*

\* Automatic Transmission only

Refer to the *Owner's Manual* for more details.

## Automatic Transmission (if equipped)

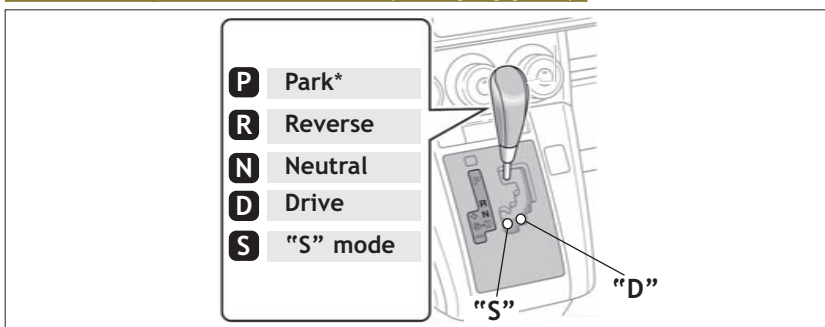

\* The engine switch must be "ON" and the brake pedal depressed to shift from Park.

### "S" (Sequential) mode

Push shift lever to the left from "D" position.

"S" position:

- +: Upshift (push and release)
- : Downshift (pull and release)

Downshifting increases power going uphill, or provides engine braking downhill. For best fuel economy during normal driving conditions, always drive with the shift lever in the "D" position.

## Parking brake

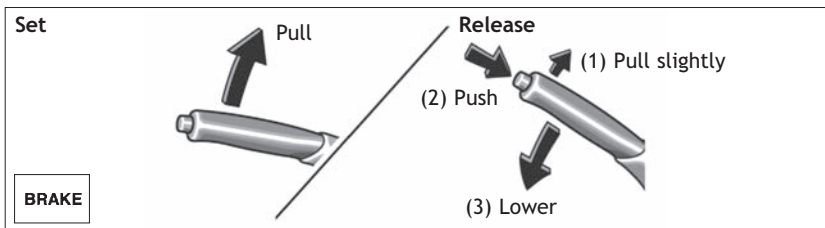

## Seats-Head restraints

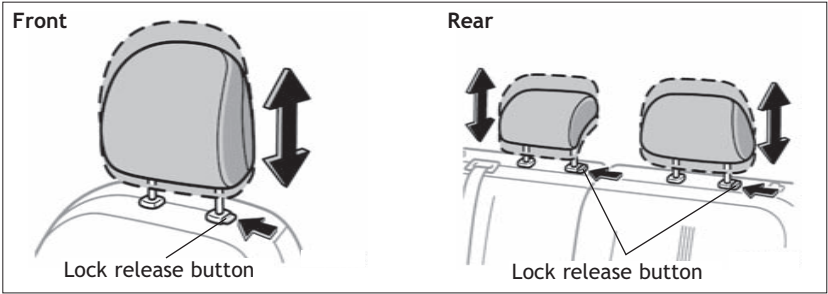

## Seat adjustments-Front



- ① Seat position (forward/backward)
- ② Height crank (driver side only)
- ③ Seatback angle

## Seat-Folding down rear seat

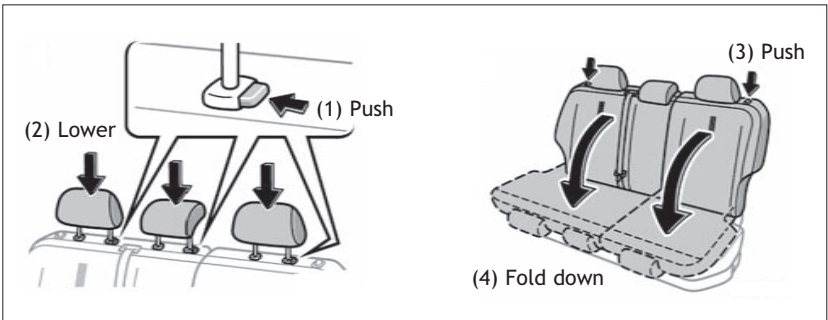

## Lights & turn signals

### Headlights

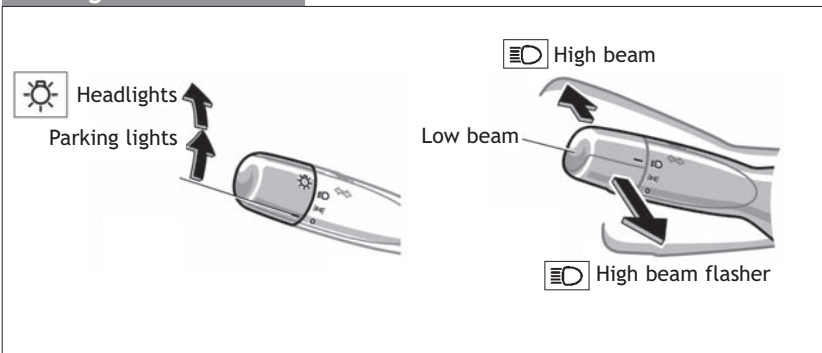

### Turn signals

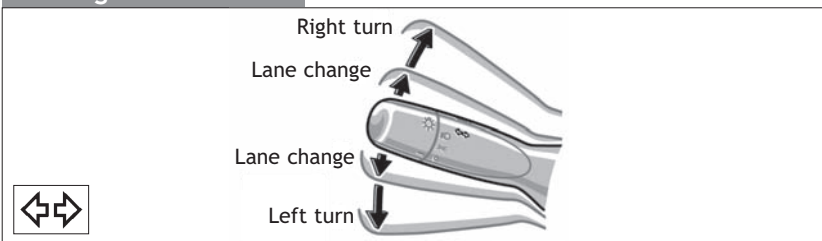

## Window wipers & washers

### Front

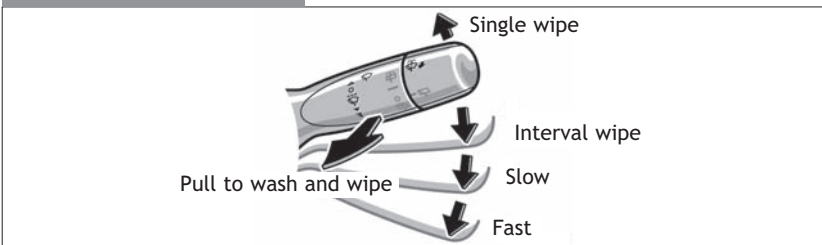

### Rear

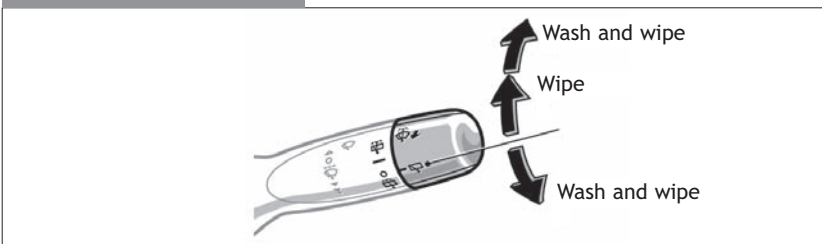

## Windows

### Driver side

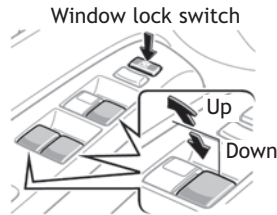
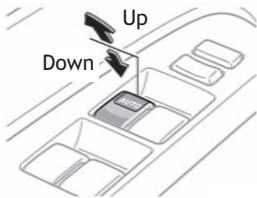

**Automatic operation (driver side only)** Push the switch completely down and release to fully open. To stop window midway, lightly pull the switch up.

**Window lock switch** Deactivates all passenger windows. Driver's window remains operable.

## Cruise control

### System ON/OFF

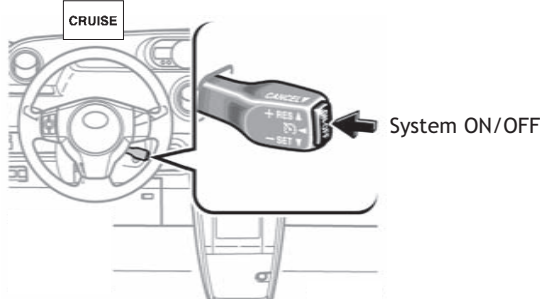

### Functions

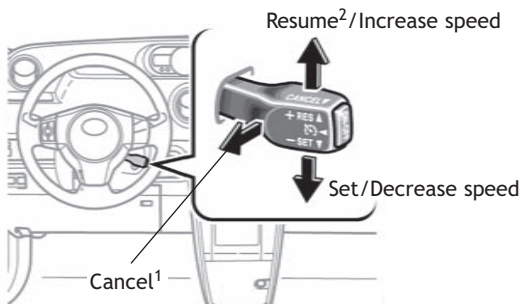

<sup>1</sup> The set speed may also be cancelled by depressing the brake pedal.

<sup>2</sup> The set speed may be resumed once vehicle speed reaches 25 mph.

## Tilt steering wheel



Hold wheel, push lever down, set angle and return lever.

**Note:** Do not attempt to adjust while the vehicle is in motion.

## Air Conditioning/Heating

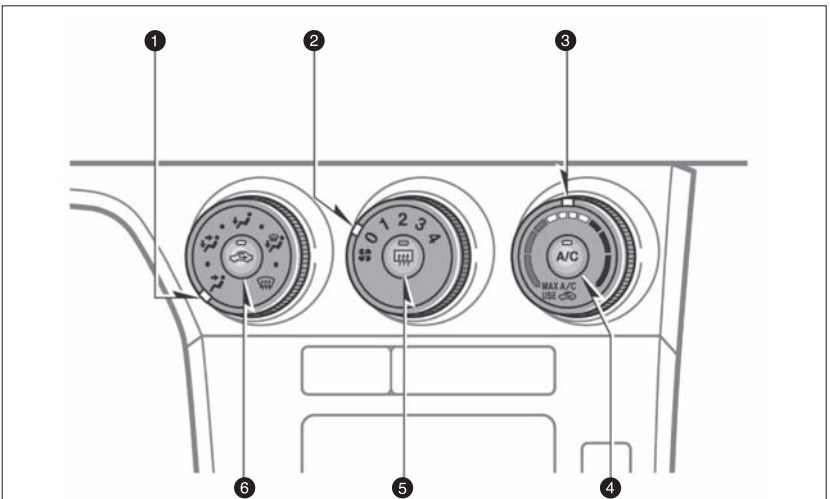

- ❶ Airflow vent  
In “” or “” mode, use fresh air (“” indicator “OFF”) to reduce window fogging.
- ❷ Fan speed
- ❸ Temperature selector
- ❹ Air Conditioning ON/OFF  
Use fresh air to quickly cool interior, then change to recirculate for cooler air.
- ❺ Rear window defogger
- ❻ Fresh or recirculated cabin air

## Steering wheel switches

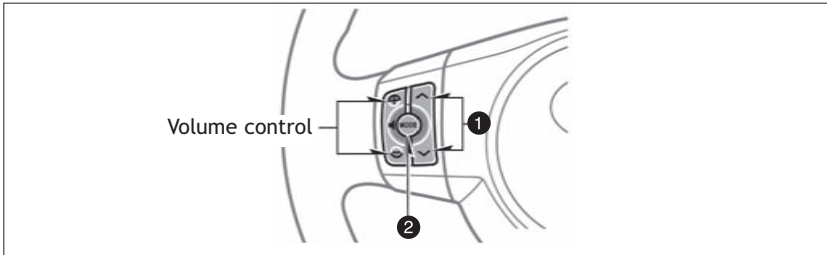

### ① " ^ v "

-In radio mode Push to select a preset station; push and hold to seek the next strong station.

-In CD mode Push to skip up or down to a next/previous track.

### ② "MODE"

Push to turn audio ON and select an audio mode. Push and hold to turn the audio system OFF.

Refer to the *SCION Audio System Owner's Manual* or *SCION Navigation System Owner's Manual* for more details.

## USB/AUX audio jack

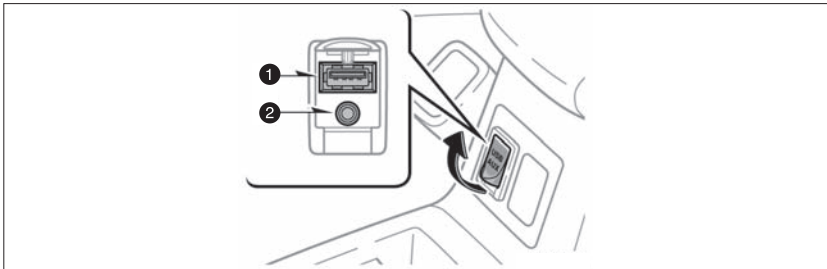

### ① USB adapter

By connecting a USB-compatible portable audio device or USB memory to the USB adapter, you can listen to music from the portable audio device or USB memory through the vehicle's speaker system.

### ② AUX jack

By inserting a mini plug into the AUX jack, you can listen to music from a portable audio device through the vehicle's speaker system.

If you do not have a SCION genuine audio system, you will not be able to use the USB adapter or AUX jack.

Refer to the *SCION Audio System Owner's Manual* or *SCION Navigation System Owner's Manual* for more details.

## Power outlet

Instrument panel

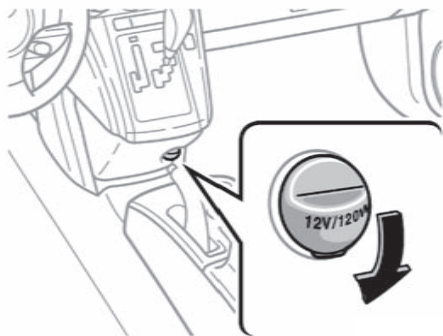

Designed for car accessories. Key must be in the "ACC" or "ON" position to use.

## Bottle holders

Front door

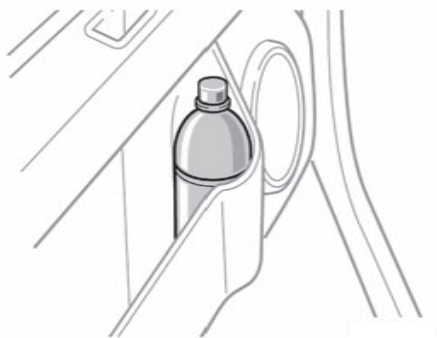



## Multi-information display

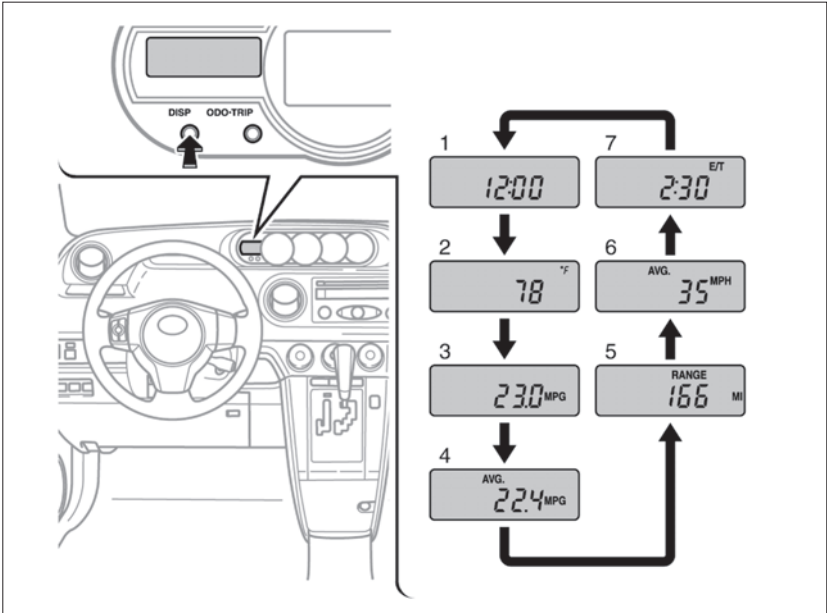

Push "DISP" to change information in the following succession:

- (1) Clock
- (2) Outside temperature
- (3) Current gas mileage (MPG)
- (4) Average gas mileage (AVG/MPG)
- (5) Miles left on remaining fuel (RANGE/MI)
- (6) Average vehicle speed from engine start (AVG/MPH)
- (7) Running time from engine start (E/T)

# SAFETY AND EMERGENCY FEATURES

## Door locks

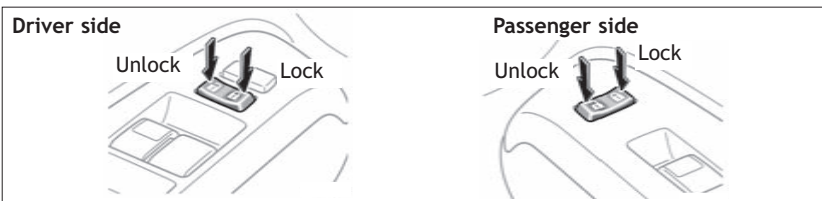

## Doors-Child safety locks

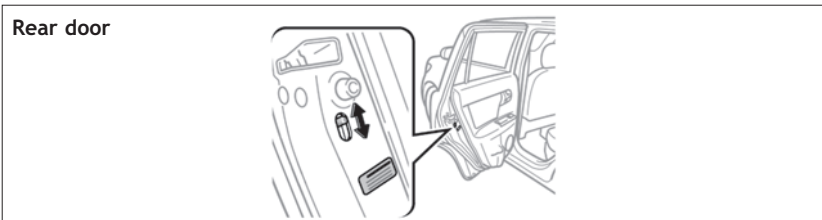

Moving the lever to "LOCK" will allow the door to be opened only from the outside.

## Seat belts-Shoulder belt anchor

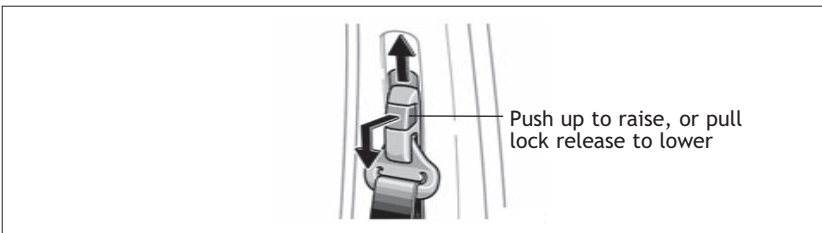

## Seat belts

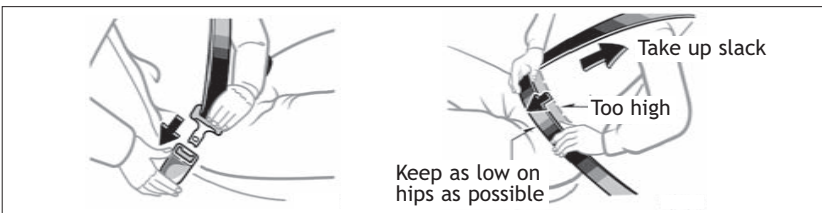

If belt is fully extended, then retracted even slightly, it cannot be re-extended beyond that point, unless fully retracted again. This feature is used to help hold child restraint systems securely.

To find more information about seatbelts, and how to install a child restraint system, refer to the *Owner's Manual*.

## Tire Pressure Monitoring (warning) System

If tire pressure indicator is on, check/adjust each tire.

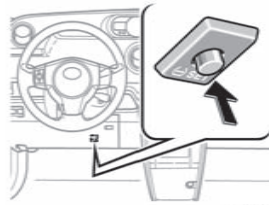

After adjusting tire pressures, or after tires have been rotated or replaced, turn the ignition switch to "ON" and press and hold the "SET" button until indicator blinks three times. Let the vehicle sit for a few minutes to allow initialization to complete.

Refer to the load label on the door jamb or the *Owner's Manual* for tire inflation specifications.

If the tire pressure indicator flashes for more than 60 seconds and then remains on, take the vehicle to your local Toyota dealer.

**Note:** The warning light may come on due to temperature changes or changes in tire pressure from natural air leakage. If the system has not been initialized recently, setting the tire pressures to factory specifications should turn off the light.

## Spare tire & tools

### Tool and spare tire location

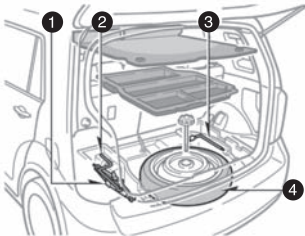

- ① Jack
- ② Jack handle
- ③ Wheel nut wrench
- ④ Spare tire

### Removing the spare tire

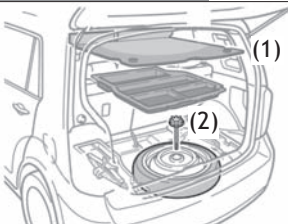

- (1) Remove the spare tire cover.
- (2) Loosen and remove the bolt.

Refer to the *Owner's Manual* for jack positioning and tire changing procedures.

EMAIL

[www.scion.com](http://www.scion.com)

→ Contact

-

CHAT

[www.scion.com](http://www.scion.com)

→ Have a Question?

→ Contact

-

PHONE

1.866.70.SCION

-

MAIL

SCION

19001 S. Western Ave.

D102, P.O. Box 2742

Torrance, CA 90509-2742

USA

-

WEB

[www.scion.com](http://www.scion.com)

-



**Mixed Sources**

Product group from well-managed  
forests, controlled sources and  
recycled wood or fiber

[www.fsc.org](http://www.fsc.org) Cert no. SGS-COC-005612  
© 1996 Forest Stewardship Council



©2009 Scion, a marque of Toyota Motor Sales, U.S.A., Inc.

Printed in U.S.A. 03/09

08-TCS-03066

00505-QR610-XB

## Free Manuals Download Website

<http://myh66.com>

<http://usermanuals.us>

<http://www.somanuals.com>

<http://www.4manuals.cc>

<http://www.manual-lib.com>

<http://www.404manual.com>

<http://www.luxmanual.com>

<http://aubethermostatmanual.com>

Golf course search by state

<http://golfingnear.com>

Email search by domain

<http://emailbydomain.com>

Auto manuals search

<http://auto.somanuals.com>

TV manuals search

<http://tv.somanuals.com>