

Operating Instructions

OVEN

GB

English, 1

SY89PG
SE89PG X
SE89PG
SH89PX

GB

Contents

Installation, 2

Positioning

Electrical connection, 3

Data plate

Description of the appliance, 4

Overall view

Control panel

Display

Start-up and use, 5

Setting the clock

Setting the timer

Starting the oven

Cooking modes, 6-8

Cooking modes

Programming cooking

Practical cooking advice

Cooking advice table

Precautions and tips, 9

General safety

Disposal

Respecting and conserving the environment

Care and maintenance, 10-12

Switching the appliance off

Cleaning the appliance

Cleaning the oven door

Replacing the light bulb

Automatic cleaning using the FAST CLEAN function

Assistance

Guarantee, 13

After Sales Service, 14

 **Hotpoint**

Installation

GB

! Before operating your new appliance please read this instruction booklet carefully. It contains important information concerning the safe operation, installation and maintenance of the appliance.

! Please keep these operating instructions for future reference. Pass them on to possible new owners of the appliance.

Positioning

! Keep packaging material out of the reach of children.
It can become a choking or suffocation hazard. (see *Precautions and tips*).

! The appliance must be installed by a qualified professional in accordance with the instructions provided. Incorrect installation may cause harm to people and animals or may damage property.

Built-in appliance

Use the appropriate cabinet to ensure that the appliance functions properly.

- The panels adjacent to the oven must be made of heat-resistant material.
- Cabinets with a veneer exterior must be assembled with glues which can withstand temperatures of up to 100°C.
- to install the oven under the counter (see *diagram*) or in a kitchen unit, the cabinet must have the following dimensions:

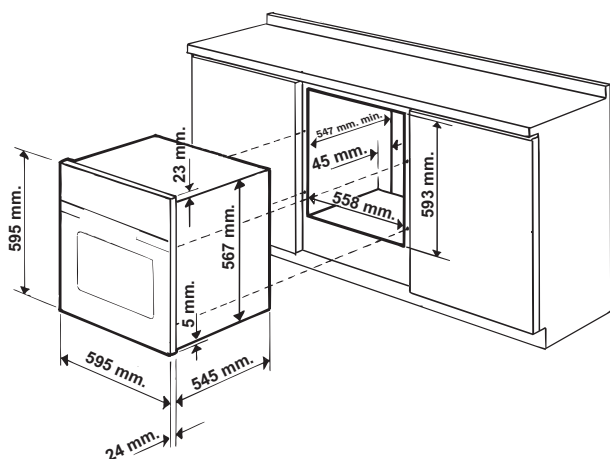

! The appliance must not come into contact with electrical parts once it has been installed. The indications for consumption given on the data plate have been calculated for this type of installation.

Ventilation

To ensure adequate ventilation is provided, the back panel of the cabinet must be removed. It is advisable to install the oven so that it rests on two strips of wood, or on a completely flat surface with an opening of at least 45 x 560 mm (see *diagrams*).

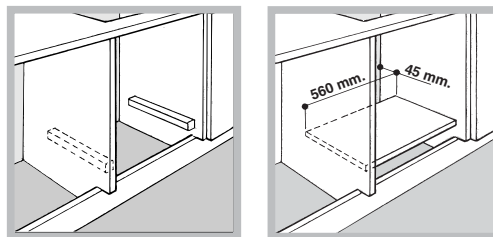

Centring and fixing

Position the 4 tabs on the side of the oven, in line with the 4 holes on the outer frame. Adjust the tabs according to the thickness of the cabinet side panel, as shown below:

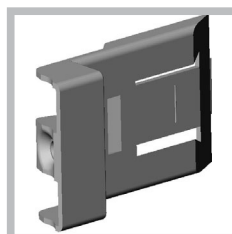

20 mm thick: take off the removable part of the tab (see *diagram*).

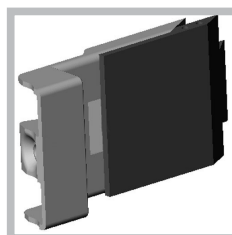

18 mm thick: use the first groove, which has already been set in the factory (see *diagram*).

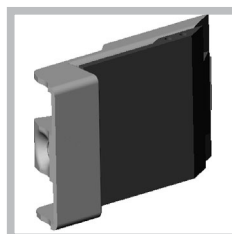

16 mm thick: use the second groove (see *diagram*).

Secure the appliance to the cabinet by opening the oven door and inserting 4 screws into the 4 holes on the outer frame.

! All parts which ensure the safe operation of the appliance must not be removable without the aid of a tool.

Electrical connection

The electrical connection to the mains must be made on the appliance. The power voltage and frequency are as indicated on the rating plate.

! THIS APPLIANCE MUST BE EARTHED.

Connecting the power supply cable

To open the terminal board:

- Using a screwdriver, press on the tabs situated on each side of the terminal board cover.
- Pull open the terminal board cover.

To connect the power supply cable, proceed as follows:

- Unscrew the cable clamp screw and the contact screws L-N- \perp .
- Fasten the wires beneath the screwheads using the following colour scheme: **Blue** (N) **Brown** (L) **Yellow-Green** \perp
- Fasten the power supply cable in the corresponding cable clamp and close the cover.

Electrical Connection:

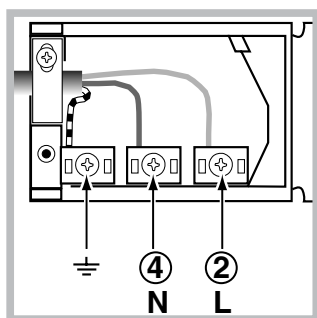

Voltage Frequency: 230 V-1+N 50Hz
 Fuse Section: 16A
 Supply cable: 3x1.5mm²

You can connect your oven to the system means of a terminal board. Refer to above information for the minimal cable sections and the calibration of the protective elements according to the connection. If the appliance is installed **with a junction box**, an **omnipolar circuit breaker** - with a minimum contact opening of 3mm - should be installed between the appliance and the mains.

Power cable supply connection to the electrical mains:

We recommend you use a power supply cable which is long enough to allow you to take the oven out of its recess in the event of maintenance operations (only use HAR - H 05 - RRF quality cables fitted with a plug conforming to the regulations in force. The plug must be accessible at all times.

Unplug the appliance before all operations, even when replacing the oven lamp.

Using the appliance without correct earthing is highly dangerous.

! After connecting the appliance to the flexible cable, tighten all the screws on the terminal board.

TABLE OF CHARACTERISTICS

Dimensions	width 43.5 cm height 32 cm depth 40 cm
Volume	56 l
Dimensions *	width 43.5 cm height 32 cm depth 41.5 cm
Volume *	58 l
Electrical connections	voltage: 220 - 240 V~ 50/60Hz maximum power absorbed 2800 W (see data plate)
ENERGY LABEL	<p>Directive 2002/40/EC on the label of electric ovens. Standard EN 50304</p> <p>Energy consumption for Natural convection – heating mode: <input type="checkbox"/></p> <p>Traditional mode</p> <p>Declared energy consumption for Forced convection Class – heating mode: <input checked="" type="checkbox"/> Baking</p>
 	<p>This appliance conforms to the following European Economic Community directives: 2006/95/EEC dated 12/12/06 (Low Voltage) and subsequent amendments – 2004/108/EEC dated 15/12/04 (Electromagnetic Compatibility) and subsequent amendments - 93/68/EEC dated 22/07/93 and subsequent amendments. 2002/96/EC and subsequent amendments. 1275/2008 stand-by/off mode</p>

* With glass panel fitted to the inside of the door

Description of the appliance

GB

Overall view

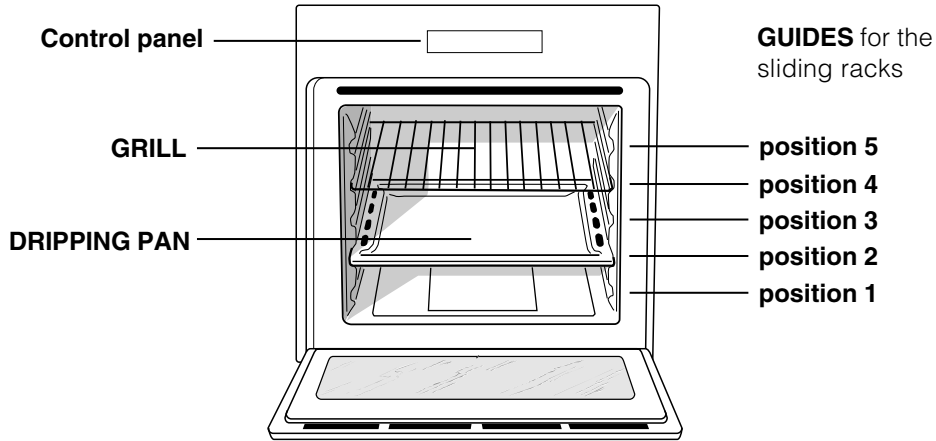

Control panel

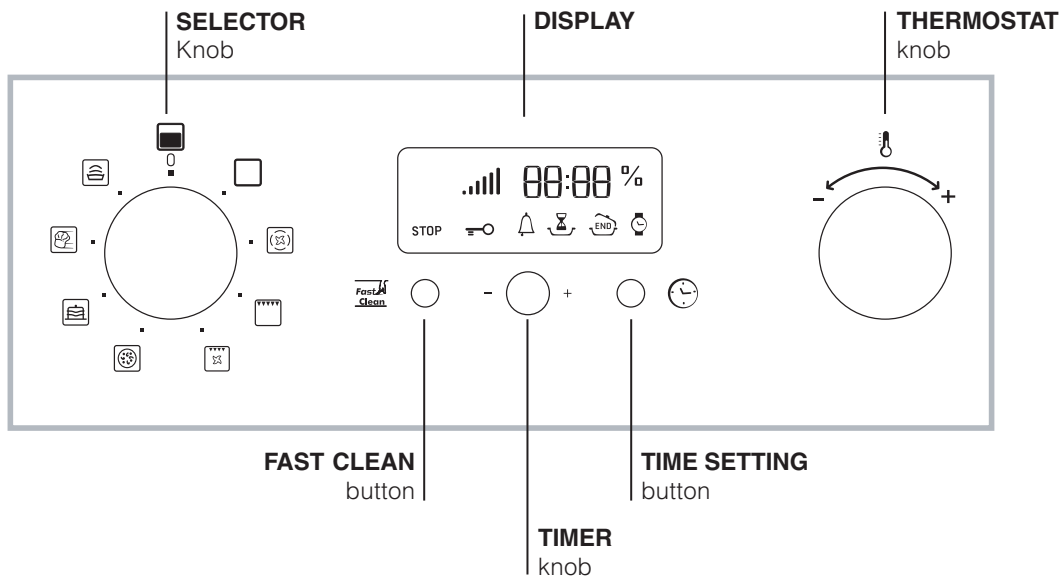



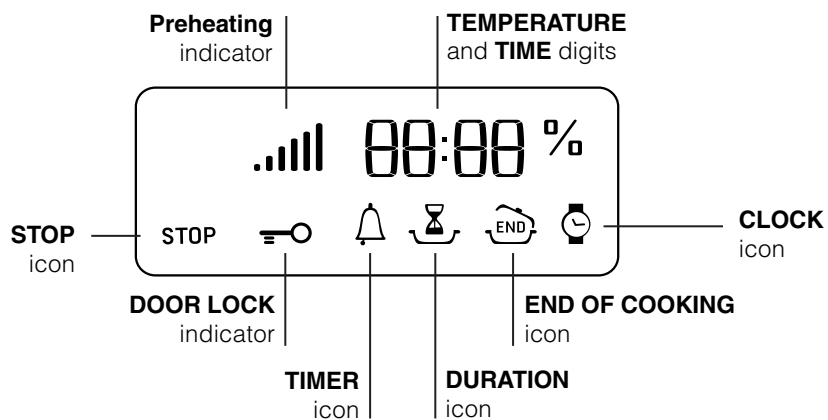

Display



! The first time you use your appliance, heat the empty oven with its door closed at its maximum temperature for at least half an hour. Ensure that the room is well ventilated before switching the oven off and opening the oven door. The appliance may emit a slightly unpleasant odour caused by protective substances used during the manufacturing process burning away.



Setting the clock

! The clock may be set when the oven is switched off or when it is switched on, provided that at the end time of a cooking cycle has not been programmed previously.

1. Press the  button several times until the  icon and the first two digits on the display start to flash.
2. Turn the TIMER KNOB towards “+” and “-” to adjust the hour value.
3. Press the  button again until the other two digits on the DISPLAY begin to flash.
4. Turn the TIMER KNOB towards “+” and “-” to adjust the minute value.
5. Press the  button again to confirm.

Setting the timer

! This function does not interrupt cooking and does not affect the oven; it is simply used to activate the buzzer when the set amount of time has elapsed.

1. Press the  button several times until the  icon and the three digits on the display begin to flash.
2. Turn the TIMER KNOB towards “+” and “-” to adjust the minute value.
3. Press the  button again to confirm.
The display will then show the time as it counts down. When this period of time has elapsed the buzzer will be activated.

Starting the oven

1. Select the desired cooking mode by turning the SELECTOR knob.
2. The oven begins its preheating stage and the preheating indicator lights up.
The temperature may be changed by turning the THERMOSTAT knob
3. When the preheating indicator  switches off and a buzzer sounds the preheating process is

complete: you may now place the food in the oven.

4. During cooking it is always possible to:
 - change the cooking mode by turning the SELECTOR knob
 - change the temperature by turning the THERMOSTAT knob
 - set the cooking duration in addition to the cooking end time
(see *Cooking modes*)
 - stop cooking by turning the SELECTOR knob to the “0” position.

5. The oven switches off automatically after two hours: this default period of time is set for all cooking modes for safety reasons.

The cooking duration may be changed
(see *Cooking modes*).

6. If a blackout occurs while the oven is already in operation, an automatic system within the appliance will reactivate the cooking mode from where it was interrupted as long as the temperature has not dropped below a certain level. Programmed cooking modes which have not started will not be restored and must be reprogrammed.

! There is no preheating stage for the FAST COOKING and BARBECUE modes.

! Never put objects directly on the bottom of the oven; this will avoid the enamel coating being damaged.

! Always place cookware on the rack(s) provided.

Cooling ventilation

In order to cool down the external temperature of the oven, a cooling fan blows a stream of air between the control panel and the oven door. In the FAST COOKING mode, the fan is activated automatically after ten minutes. In the BAKING mode, the cooling fan is only activated when the oven is hot. At the beginning of the FAST CLEAN mode, the cooling fan operates at low speed.

! Once cooking has been completed, the cooling fan continues to operate until the oven has cooled down sufficiently.

Oven light

When the oven is not in operation, the lamp can be switched on at any time by opening the oven door.

Cooking modes

GB

Cooking modes

! All cooking modes have a default cooking temperature which may be adjusted manually between 40°C and 250°C as desired. In the BARBECUE mode, the default power level value is indicated as a percentage (%) and may also be adjusted manually.

TRADITIONAL OVEN mode

When using this traditional cooking mode, it is best to use one cooking rack only. If more than one rack is used, the heat will be distributed unevenly.

MULTI-COOKING mode

Since the heat remains constant throughout the oven, the air cooks and browns food in a uniform manner. A maximum of two racks may be used at the same time.

BARBECUE mode

By turning the THERMOSTAT knob, the different power levels which may be set will appear on the display; these range between 50% and 100%. The high and direct temperature of the grill is recommended for food which requires a high surface temperature. Always cook in this mode with the oven door closed.

GRATIN mode

This combination of features increases the effectiveness of the unidirectional thermal radiation provided by the heating elements through forced circulation of the air throughout the oven. This helps prevent food from burning on the surface and allows the heat to penetrate right into the food. Always cook in this mode with the oven door closed.

PIZZA OVEN mode

This combination heats the oven rapidly by producing a considerable amount of heat, particularly from the element at the bottom. If you use more than one rack at a time, switch the position of the dishes halfway through the cooking process.

BAKING mode

This mode is ideal for baking temperature sensitive foods (such as cakes, which need to rise) and for the preparation of "bitesize pastries" on 3 shelves simultaneously.

FAST COOKING mode

Preheating is not necessary for this cooking mode. This mode is particularly suitable for cooking pre-packed food quickly (frozen or pre-cooked). The best results are achieved using one cooking rack only.



PROVING mode

The oven reaches and maintains a temperature of 40°C irrespective of the position of the THERMOSTAT knob. This mode is ideal for leavening dough made with yeast.

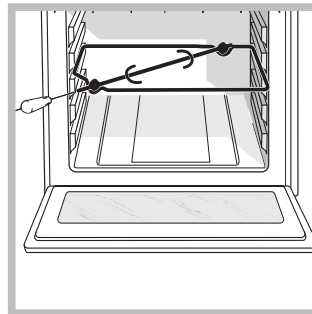
Spit roast (only available in certain models)



To operate the spit roast function (see diagram) proceed as follows:



1. Place the dripping pan in position 1.
2. Place the rotisserie support in position 3 and insert the spit in the hole provided on the back panel of the oven.
3. Start the rotisserie using the SELECTOR knob to select mode  or .

! When the  mode is activated, the spit will stop if the door is opened.

Programming cooking







! A cooking mode must be selected before programming can take place.

Programming the cooking duration

1. Press the  button several times until the  icon and the three digits on the DISPLAY begin to flash.
2. Turn the TIMER KNOB towards "+" and "-" to adjust the duration.
3. Press the  button again to confirm.
4. When the set time has elapsed, the text END appears on the DISPLAY, the oven will stop cooking and a buzzer sounds.
 - For example: it is 9:00 a.m. and a time of 1 hour and 15 minutes is programmed. The programme will stop automatically at 10:15 a.m.

Setting the end time for a cooking mode

! A cooking duration must be set before the end cooking time can be scheduled.

1. Follow steps 1 to 3 to set the duration as detailed above.
 2. Next, press the  button until the  icon and the two digits on the DISPLAY begin to flash.
 3. Turn the TIMER KNOB towards "+" and "-" to adjust the hour value.
 4. Press the  button again until the other two digits on the DISPLAY begin to flash.
 5. Turn the TIMER KNOB towards "+" and "-" to adjust the minute value.
 6. Press the  button again to confirm.
 7. When the set time has elapsed, the text END appears on the DISPLAY, the oven will stop cooking and a buzzer sounds.
- Programming has been set when the  and  buttons are illuminated. The DISPLAY shows the cooking end time and the cooking duration alternately.
- To cancel programming, turn the SELECTOR knob to the "0" position.

Practical cooking advice

! Do not place racks in position 1 and 5 during fan-assisted cooking. This is because excessive direct heat can burn temperature sensitive foods.

! In the BARBECUE and GRATIN cooking modes, particularly when using the rotisserie spit, place the dripping pan in position 1 to collect cooking residues (fat and/or grease).

MULTI-COOKING

- Use positions 2 and 4, placing the food which requires more heat on 2.
- Place the dripping pan on the bottom and the rack on top.

BARBECUE

- Place the rack in position 3 or 4. Position the food in the centre of the rack.
- We recommend that the power level is set to maximum. The top heating element is regulated by a thermostat and may not always operate constantly.

PIZZA OVEN

- Use a light aluminium pizza pan. Place it on the rack provided.
For a crispy crust, do not use the dripping pan as it prevents the crust from forming by extending the total cooking time.
- If the pizza has a lot of toppings, we recommend adding the mozzarella cheese on top of the pizza halfway through the cooking process.

Cooking advice table

Cooking modes	Foods	Weight (in kg)	Rack position		Preheating	Recommended Temperature (°C)	Cooking duration (minutes)
			Standard guide rails	Sliding guide rails			
Convection Oven	Duck	1.5	2	1	Yes	200-210	70-80
	Chicken	1.5	2	1	Yes	200-210	60-70
	Roast veal or beef	1	2	1	Yes	200	70-75
	Roast pork	1	2	1	Yes	200-210	70-80
	Biscuits (shortcrust pastry)	-	2	1	Yes	180	15-20
	Pies / Tarts	1	2	1	Yes	180	30-35
Multi-cooking	Pizza on 2 racks		2 and 4	1 and 3	Yes	220-230	20-25
	Pies on two racks/cakes on 2 racks		2 and 4	1 and 3	Yes	180	30-35
	Sponge cake on 2 racks (on the dripping pan)		2 and 4	1 and 3	Yes	170	20-25
	Roast chicken + potatoes	1+1	1 and 2/3	1 and 3	Yes	200-210	65-75
	Lamb	1	2	1	Yes	190-200	45-50
	Mackerel	1	1 or 2	1	Yes	180	30-35
	Lasagne	1	2	1	Yes	190-200	35-40
	Cream puffs on 2 racks		2 and 4	1 and 3	Yes	190	20-25
	Biscuits on 2 racks		2 and 4	1 and 3	Yes	190	10-20
	Cheese puffs on 2 racks		2 and 4	1 and 3	Yes	210	20-25
	Savoury pies		1 and 3	1 and 3	Yes	200	20-30
Barbecue	Mackerel	1	4	3	No	100%	15-20
	Sole and cuttlefish	0.7	4	3	No	100%	10-15
	Squid and prawn kebabs	0.7	4	3	No	100%	8-10
	Cod fillet	0.7	4	3	No	100%	10-15
	Grilled vegetables	0.5	3 or 4	2 or 3	No	100%	15-20
	Veal steak	0.8	4	3	No	100%	15-20
	Sausages	0.7	4	3	No	100%	15-20
	Hamburgers	4 or 5	4	3	No	100%	10-12
	Toasted sandwiches (or toast)	4 or 6	4	3	No	100%	3-5
	Spit-roast chicken using rotisserie spit (where present)	1	-	-	No	100%	70-80
	Spit-roast lamb using rotisserie spit (where present)	1	-	-	No	100%	70-80
Gratin	Grilled chicken	1.5	2	2	No	210	55-60
	Cuttlefish	1	2	2	No	200	30-35
	Spit-roast chicken using rotisserie spit (where present)	1.5	-	-	No	210	70-80
	Spit-roast duck using rotisserie spit (where present)	1.5	-	-	No	210	60-70
	Roast veal or beef	1	2	2	No	210	60-75
	Roast pork	1	2	2	No	210	70-80
	Lamb	1	2	2	No	210	40-45
Pizza Oven	Pizza	0.5	2	1	Yes	220	15-20
	Focaccia bread	0.5	2	1	Yes	200	20-25
Baking mode	Pies / Tarts	0.5	2 or 3	1 or 2	Yes	180	25-35
	Fruit cakes	1	2 or 3	1 or 2	Yes	180	40-50
	Sponge cake made with yoghurt	0.7	2 or 3	1 or 2	Yes	170-180	45-55
	Small cakes on 2 racks	0.7	2 and 4	1 and 3	Yes	180-190	20-25
	Sponge cake	0.6	2 or 3	1 or 2	Yes	160-170	30-40
	Cream puffs on 3 racks	0.7	1, 3 and 5	1, 2 and 4	Yes	180-190	20-25
	Biscuits on 3 racks	0.7	1, 3 and 5	1, 2 and 4	Yes	180	20-25
	Filled pancakes	0.8	2	1	Yes	200	30-35
	Meringues on 3 racks	0.5	1, 3 and 5	1, 2 and 4	Yes	90	180
	Cheese puffs	0.5	2	1	Yes	210	20-25
Fast cooking	Frozen food						
	Pizza	0.3	2	1	-	250	12
	Courgette and prawn pie	0.4	2	1	-	200	20
	Country style spinach pie	0.5	2	1	-	220	30-35
	Turnovers	0.3	2	1	-	200	25
	Lasagne	0.5	2	1	-	200	35
	Golden Rolls	0.4	2	1	-	180	25-30
	Chicken bites	0.4	2	1	-	220	15-20
	Pre-cooked food						
	Golden chicken wings	0.4	2	1	-	200	20-25
	Fresh Food						
	Biscuits (shortcrust pastry)	0.3	2	1	-	200	15-18
	Sponge cake made with yoghurt	0.6	2	1	-	180	45
Cheese puffs	0.2	2	1	-	210	10-12	
Proving	Rising process for dough made with yeast (brioches, bread, sugar pie, croissants, etc.)		2	1		40	30-60

! The cooking times listed above are intended as guidelines only and may be modified according to personal tastes. Oven preheating times are set as standard and may not be modified manually.

! This appliance has been designed and manufactured in compliance with international safety standards. The following warnings are provided for safety reasons and must be read carefully.

General safety

- The appliance was designed for domestic use inside the home and is not intended for commercial or industrial use.
- The appliance must not be installed outdoors, even in covered areas. It is extremely dangerous to leave the appliance exposed to rain and storms.
- When moving or positioning the appliance, always use the handles provided on the sides of the oven.
- Do not touch the appliance with bare feet or with wet or damp hands and feet.
- The appliance must be used by adults only for the preparation of food, in accordance with the instructions provided in this booklet.
- **Do not touch the heating elements and parts of the oven door when the appliance is in use; these parts become extremely hot. Keep children well away from the appliance.**
- Ensure that the power supply cables of other electrical appliances do not come into contact with the hot parts of the oven.
- The openings used for the ventilation and dispersion of heat must never be covered.
- Always grip the oven door handle in the centre: the ends may be hot.
- Always use oven gloves when placing cookware in the oven or when removing it.
- Do not use aluminium foil to line the bottom of the oven.
- Do not place flammable materials in the oven: If the appliance is switched on accidentally, it could catch fire.
- When unplugging the appliance, always pull the plug from the mains socket; do not pull on the cable.
- Never perform any cleaning or maintenance work without having disconnected the appliance from the electricity mains.
- If the appliance breaks down, under no circumstances should you attempt to perform the repairs yourself. Repairs carried out by inexperienced persons may cause injury or further malfunctioning of the appliance. Contact a Service Centre (*see Assistance*).
- Do not rest heavy objects on the open oven door.
- The appliance should not be operated by people (including children) with reduced physical, sensory or mental capacities, by inexperienced individuals or by anyone who is not familiar with the product. These individuals should, at the very least, be supervised by someone who assumes

responsibility for their safety or receive preliminary instructions relating to the operation of the appliance.

- Do not let children play with the appliance.

Disposal

- When disposing of packaging material: observe local legislation so that the packaging may be reused.
- The European Directive 2002/96/EC relating to Waste Electrical and Electronic Equipment (WEEE) states that household appliances should not be disposed of using the normal solid urban waste cycle. Exhausted appliances should be collected separately in order to optimise the cost of re-using and recycling the materials inside the machine, while preventing potential damage to the atmosphere and to public health. The crossed-out dustbin is marked on all products to remind the owner of their obligations regarding separated waste collection. For further information relating to the correct disposal of exhausted household appliances, owners may contact the public service provided or their local dealer.

Respecting and conserving the environment

- You can help to reduce the peak load of the electricity supply network companies by using the oven in the hours between late afternoon and the early hours of the morning. The cooking mode programming options, the “delayed cooking” mode (*see Cooking modes*) and “delayed automatic cleaning” mode (*see Care and Maintenance*) in particular, enable the user to organise their time efficiently.
- Always keep the oven door closed when using the BARBECUE and GRATIN modes: This will achieve improved results while saving energy (approximately 10%).
- Check the door seals regularly and wipe them clean to ensure they are free of debris so that they adhere properly to the door, thus avoiding heat dispersion.

! This product complies with the requirements of the latest European Directive on the limitation of power consumption of the standby mode.

If no operations are carried out for a period of 2 minutes, the appliance automatically switches to the standby mode.

The standby mode is visualised by the high luminosity “Watch Icon”.

As soon as interaction with the machine resumes, the system's operating mode is restored.

Care and maintenance

GB

Switching the appliance off

Disconnect your appliance from the electricity supply before carrying out any work on it.

Cleaning the appliance

- The stainless steel or enamel-coated external parts and the rubber seals may be cleaned using a sponge that has been soaked in lukewarm water and neutral soap. Use specialised products for the removal of stubborn stains. After cleaning, rinse and dry thoroughly. Do not use abrasive powders or corrosive substances.
- The inside of the oven should ideally be cleaned after each use, while it is still lukewarm. Use hot water and detergent, then rinse well and dry with a soft cloth. Do not use abrasive products.
- The accessories can be washed like everyday crockery, and are even dishwasher safe.

! Never use steam cleaners or pressure cleaners on the appliance.

Cleaning the oven door

Clean the glass part of the oven door using a sponge and a non-abrasive cleaning product, then dry thoroughly with a soft cloth. Do not use rough abrasive material or sharp metal scrapers as these could scratch the surface and cause the glass to crack. For more thorough cleaning purposes, the oven door may be removed:

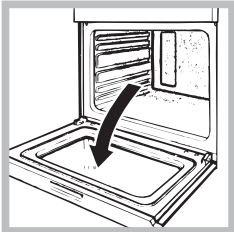

1. Open the oven door fully (see diagram).

2. Lift up and turn the small levers located on the two hinges (see diagram).

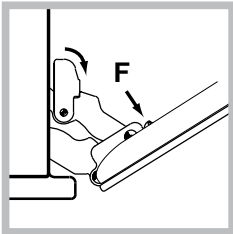

With glass panel fitted to the inside of the door

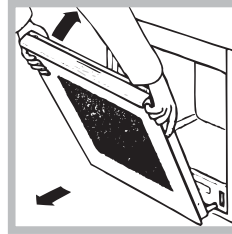
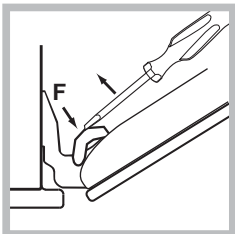

3. Grip the door on the two external sides and close it approximately half way. Pull the door towards you, lifting it out of its slot (see diagram).

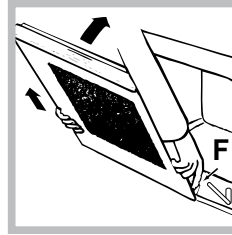

3. (With glass panel fitted to the inside of the door) Grip the door on the two external sides and close it approximately half way. Unlock the door by pressing on the clamps **F**, then pull the door towards you lifting it out of its seat (see diagram).

To replace the door, reverse this sequence.

Inspecting the seals

Check the door seals around the oven periodically. If the seals are damaged, please contact your nearest After-sales Service Centre (see Assistance). We recommend that the oven is not used until the seals have been replaced.

Replacing the light bulb

To replace the oven light bulb:

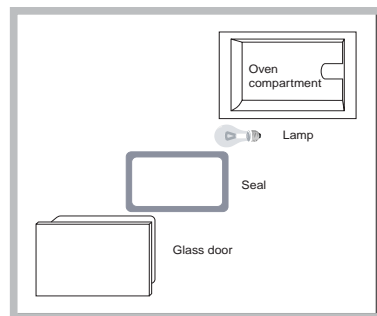

1. Remove the glass cover using a screwdriver.
 2. Unscrew the light bulb and replace it with a similar one: Wattage 15 W, cap E 14.
- Replace the glass cover, making sure the seal is positioned correctly (see diagram).

Automatic cleaning with the FAST CLEAN function

With the FAST CLEAN mode, the internal temperature of the oven reaches 500°C. The pyrolytic cycle is activated, burning away food and grime residues. Dirt is literally incinerated. Keep children away from the appliance during the automatic cleaning cycle as surfaces may become very hot. Particles may ignite inside the oven due to the combustion process. There is no cause for concern: this process is both normal and hazard-free.

Before initiating the FAST CLEAN mode:

- Remove large or coarse food residues from the inside of the oven using a damp sponge. Do not use detergents.
- Remove all accessories.
- Do not place tea towels or pot holders over the oven handle.
- Turn the SELECTOR knob to the "0" position.

! If the oven is too hot, the pyrolytic cycle may not start. Wait for the oven to cool down.



! The programme may only be started once the oven door has been closed.

To activate the FAST CLEAN cycle press and hold the  button for approximately 4 seconds. The TIMER KNOB may be used to select the desired cleaning level; there are three default time settings which cannot be modified.





1. Economy (ECO): turn the knob towards "-". Duration 1 hour.
2. Normal (NOR): initial level. Duration 1 hour and 30 minutes.
3. Intensive (INT): turn the knob towards "+". Duration 2 hours.
4. Press the  button to confirm.



An end time for the FAST CLEAN cycle (as for a normal cooking cycle) may be programmed (see *Programming the automatic cleaning end time*).

Safety devices

- The  icon on the display, when lit, indicates that the oven door was automatically locked as soon as the temperature reached a high value.
- The **STOP** icon indicates that the cleaning cycle may be cancelled at any time by pressing the  button.
- If a malfunction occurs, the heating elements will be switched off.
- Once the oven door has been locked, you cannot change the duration and cycle end time settings.

Programming the automatic cleaning end time

1. Press the  button until the  icon and the two digits on the DISPLAY begin to flash.
 2. Turn the TIMER KNOB towards "+" and "-" to adjust the hour value.
 3. Press the  button again until the other two digits on the DISPLAY begin to flash.
 4. Turn the TIMER KNOB towards "+" and "-" to adjust the minute value.
 5. Press the  button again to confirm.
 6. When the set time has elapsed, the text END appears on the display and a buzzer sounds.
- For example: it is 9:00 a.m. and the Economy (ECO) FAST CLEAN level has been selected, with the default duration of 1 hour. 12:30 is scheduled as the end time. The programme will start automatically at 11:30 a.m.

Programming has been set when the  and  buttons are illuminated. The display shows the FAST CLEAN end time and duration alternately.

Once the automatic cleaning cycle is over

You will have to wait until the temperature inside the oven has cooled down sufficiently before you can open the oven door. You will notice some white dust deposits on the bottom and the sides of your oven; remove these deposits with a damp sponge once the oven has cooled down completely. Alternatively, you can make use of the already heated oven, in which case it is not necessary to remove the deposits, they are completely harmless and will not affect your food in any way.

Assistance

Warning:

The appliance is fitted with an automatic diagnostic system which detects any malfunctions. Malfunctions are displayed by messages of the following type: "F" followed by numbers. Call for technical assistance should a malfunction occur.

! Never use the services of an unauthorised technician.

Please have the following information to hand:

- The type of problem encountered.
- The appliance model (Mod.).
- The serial number (S/N).

The latter two pieces of information can be found on the data plate located on the appliance.

Guarantee

12 months Parts and Labour Guarantee

Your appliance has the benefit of our manufacturer's guarantee, which covers the cost of breakdown repairs for twelve months from the date of purchase.

This gives you the reassurance that if, within that time, your appliance is proven to be defective because of either workmanship or materials, we will, at our discretion, either repair or replace the appliance at no cost to you.

This guarantee is subject to the following conditions:

- The appliance has been installed and operated correctly and in accordance with our operating and maintenance instructions.
- The appliance is used only on the electricity or gas supply printed on the rating plate.
- The appliance has been used for normal domestic purposes only.
- The appliance has not been altered, serviced, maintained, dismantled, or otherwise interfered with by any person not authorised by us.
- Any repair work must be undertaken by us or our appointed agent.
- Any parts removed during repair work or any appliance that is replaced become our property.
- The appliance is used in the United Kingdom or Republic of Ireland.

The guarantee does not cover:

- Damage resulting from transportation, improper use, neglect or interference or as a result of improper installation.
- Replacement of any consumable item or accessory. These included but not limited to: plugs, cables, batteries, light bulbs, fluorescent tubes and starters, covers and filters.
- Replacement of any removable parts made of glass or plastic.

THIS GUARANTEE WILL NOT APPLY IF THE APPLIANCE HAS BEEN USED IN COMMERCIAL OR NON-DOMESTIC PREMISES.

5 Year Parts Guarantee

Hotpoint also offers you a free 5 year parts guarantee. This additional guarantee is conditional on you registering your appliance with us and the parts being fitted by one of our authorised engineers. There will be a charge for our engineer's time. To activate the extra parts warranty on your appliance, simply call our registration line on **08448 24 24 24 (Republic of Ireland 01 230 0800)**

Extended Guarantees

We offer a selection of protection plans that enable you to fully cover yourself against the expense of repair bills for the life of your policy. To find the ideal plan for you please call our advice line on **08448 226 226 (Republic of Ireland 01 230 0233)**.

Free Helpdesk Service

We have a dedicated team who can provide free advice and assistance with your appliance if you experience any technical difficulties within the first 90 days of ownership. Simply call our Hotpoint Service Hotline on **08448 224 224 (Republic of Ireland 0818 313 413)** for telephone assistance, or, where necessary, to arrange for an engineer to call.

After Sales Service

No one is better placed to care for your Hotpoint appliance during the course of its working life than us – the manufacturer.

Essential Contact Information

Hotpoint Service

We are the largest service team in the country offering you access to 400 skilled telephone advisors and 1000 fully qualified engineers on call to ensure you receive fast, reliable, local service.

UK: 08448 224 224
Republic of Ireland: 0818 313 413
www.hotpointservice.co.uk

Please note: Our advisors will require the following information:

Model number:

Serial number:

Parts and Accessories

We supply a full range of genuine replacement parts as well as accessory products that protect and hygienically clean your appliance to keep it looking good and functioning efficiently throughout its life.

UK: 08448 225 225
Republic of Ireland: 0818 313 413
www.hotpointservice.co.uk

Appliance Registration

We want to give you additional benefits of Hotpoint ownership. To activate your free 5 year parts guarantee you must register your appliance with us.

UK: 08448 24 24 24
Republic of Ireland: 01 230 0800
www.hotpointservice.co.uk

Indesit Company UK Ltd. Morley Way, Peterborough, PE2 9JB
Indesit Company Unit 49 Airways Industrial Estate, Dublin 17

Recycling and Disposal Information

As part of Hotpoint's continued commitment to helping the environment, Hotpoint reserves the right to use quality, recycled components to keep down customer costs and minimise material wastage.

Please dispose of packaging and old appliances carefully. To minimise the risk of injury to children, remove the door, plug, and cut the mains cable off flush with the appliance. Dispose of these parts separately to ensure that the appliance can no longer be plugged into mains socket, and the door cannot be locked shut.

Free Manuals Download Website

<http://myh66.com>

<http://usermanuals.us>

<http://www.somanuals.com>

<http://www.4manuals.cc>

<http://www.manual-lib.com>

<http://www.404manual.com>

<http://www.luxmanual.com>

<http://aubethermostatmanual.com>

Golf course search by state

<http://golfingnear.com>

Email search by domain

<http://emailbydomain.com>

Auto manuals search

<http://auto.somanuals.com>

TV manuals search

<http://tv.somanuals.com>