

*The Xerox  
DocuPrint N2025/N2825  
Network Laser Printer*

**User Guide**

Copyright protection claimed includes all forms and matters of copyrightable materials and information now allowed by statutory or judicial law or hereinafter granted, including without limitation, material generated from the software programs which are displayed on the screen such as styles, templates, icons, screen displays, looks, etc.

Printed in the United States of America.

XEROX® and all Xerox product names and product numbers mentioned in this publication are registered trademarks of the Xerox Corporation. Other company trademarks are also acknowledged. PCL is a trademark of the Hewlett-Packard Company. MS, MS-DOS, Windows NT, Microsoft LAN Manager, Windows 95 and Windows 98 are trademarks of Microsoft Corporation. Adobe and PostScript are trademarks of Adobe Systems, Inc. TrueType is a trademark of Apple Computer, Inc. OS/2 is a trademark of International Business Machines Corporation. SunOS and Solaris are trademarks of Sun Corporation.

This printer contains an emulation of the Hewlett Packard PCL 5e and PCL 6 command language (recognizes HP PCL 5e and PCL 6 commands) and processes these commands in a manner compatible with Hewlett Packard LaserJet printer products.

This product includes an implementation of LZW licensed under U.S. Patent 4,558,302.

Changes are periodically made to this document. Technical updates will be included in subsequent editions.

© 2000 by Xerox Corporation. All rights reserved.

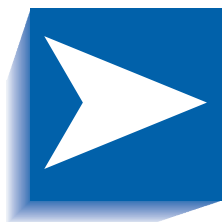

# Contents

<b>Safety Notes</b> .....	<b><i>i</i></b>
<i>Note, Caution and Warning Symbols</i> .....	<i>ii</i>
<i>Electrical Safety</i> .....	<i>iii</i>
<i>Laser Safety</i> .....	<i>v</i>
<i>Maintenance Safety</i> .....	<i>vi</i>
<i>Operational Safety</i> .....	<i>vii</i>
<i>Ozone Safety</i> .....	<i>x</i>
<b>Chapter 1 Getting to Know Your Printer</b> .....	<b><i>1-1</i></b>
<i>Introduction</i> .....	<i>1-2</i>
<i>Printer Features</i> .....	<i>1-3</i>
<i>Paper Handling</i> .....	<i>1-3</i>
<i>Connectivity</i> .....	<i>1-4</i>
<i>Page Description Languages</i> .....	<i>1-5</i>
<i>Fonts</i> .....	<i>1-5</i>
<i>Resolution</i> .....	<i>1-5</i>
<i>Print Speed</i> .....	<i>1-5</i>
<i>Printer Components</i> .....	<i>1-6</i>
<i>Base Configuration</i> .....	<i>1-6</i>

	<i>Internal Components</i> .....	1-7
	<i>Printer Options</i> .....	1-8
	<i>Printer Documentation</i> .....	1-9
	<i>Printed Documentation</i> .....	1-9
	<i>Using the CDs</i> .....	1-10
	<i>Product CD</i> .....	1-11
	<i>Printer Management Software CD</i> .....	1-11
<b>Chapter 2</b>	<b><i>Loading Print Media</i></b> .....	<b>2-1</b>
	<i>Selecting Print Media</i> .....	2-2
	<i>Storing Paper</i> .....	2-6
	<i>Loading Paper</i> .....	2-7
	<i>Tray 1, 2 or 3</i> .....	2-7
	<i>Multi Bypass Feeder</i> .....	2-16
<b>Chapter 3</b>	<b><i>Printing</i></b> .....	<b>3-1</b>
	<i>Introduction</i> .....	3-3
	<i>Using the Printer Drivers</i> .....	3-4
	<i>Installing the Printer Drivers</i> .....	3-5
	<i>Configuring the Printer Drivers</i> .....	3-5
	<i>Using the Driver's Features</i> .....	3-6
	<i>Using the PCL Driver</i> .....	3-7
	<i>Paper/Output</i> .....	3-8
	<i>Document Options</i> .....	3-12
	<i>Graphics Options</i> .....	3-15
	<i>Watermarks</i> .....	3-19
	<i>Overlays</i> .....	3-20
	<i>Using the PostScript Driver</i> .....	3-21
	<i>Paper/Output</i> .....	3-21
	<i>Document Options</i> .....	3-26
	<i>Image Options</i> .....	3-28
	<i>Fonts</i> .....	3-31
	<i>PostScript</i> .....	3-33

<i>Using the Control Panel</i> .....	3-35
<i>The Display</i> .....	3-36
<i>The Indicator Lights</i> .....	3-37
<i>The Keys</i> .....	3-38
<i>Menu Options</i> .....	3-40
<i>Printing a Password Job</i> .....	3-55
<i>Deleting a Password Job</i> .....	3-56
<i>Generating a Printer Report</i> .....	3-57
<i>Offsetting Output</i> .....	3-58
<i>Duplex Printing</i> .....	3-59
<i>Configuring Custom Paper Sizes</i> .....	3-61
<i>Special Media Printing</i> .....	3-63
<b>Chapter 4 <i>Maintaining the Printer</i></b> .....	<b>4-1</b>
<i>Regular Printer Maintenance</i> .....	4-2
<i>Cleaning the Printer</i> .....	4-2
<i>Replacing the Laser Print Cartridge</i> .....	4-3
<i>Replacing Maintenance Kit Items</i> .....	4-6
<b>Chapter 5 <i>Troubleshooting</i></b> .....	<b>5-1</b>
<i>Before You Begin Troubleshooting</i> .....	5-2
<i>Hardware</i> .....	5-3
<i>Software</i> .....	5-3
<i>Printer Maintenance</i> .....	5-3
<i>Consumables</i> .....	5-3
<i>Error Messages</i> .....	5-4
<i>Paper Jams</i> .....	5-5
<i>What Causes a Paper Jam?</i> .....	5-5
<i>Paper Jam Messages</i> .....	5-5
<i>Paper Jam While Feeding through Duplex Module</i> .....	5-7
<i>Paper Jam While Exiting to Standard Output Bin</i> .....	5-8
<i>Paper Jam While Feeding to Offset Catch Tray</i> .....	5-10
<i>Paper Jam While Feeding from Tray 1</i> .....	5-12

	<i>Paper Jam While Feeding from 2,000 Sheet Feeder.....</i>	<i>5-15</i>
	<i>Paper Jam While Feeding from 500 Sheet Feeder.....</i>	<i>5-18</i>
	<i>Paper Jam While Printing.....</i>	<i>5-23</i>
	<i>Paper Jam Because of Mismatch between Expected and Actual Size Fed .....</i>	<i>5-26</i>
	<i>Solving Printing Problems .....</i>	<i>5-27</i>
	<i>Solving Print Quality Problems .....</i>	<i>5-31</i>
	<i>Additional Sources of Troubleshooting Assistance .....</i>	<i>5-39</i>
<b>Appendix A</b>	<b><i>Printer Specifications .....</i></b>	<b><i>A-1</i></b>
	<i>Printer Specifications.....</i>	<i>A-2</i>
<b>Appendix B</b>	<b><i>Notices and Certifications .....</i></b>	<b><i>B-1</i></b>
	<i>FCC Notices...USA.....</i>	<i>B-2</i>
	<i>Radio Frequency.....</i>	<i>B-2</i>
	<i>Certifications...Canadian.....</i>	<i>B-4</i>
	<i>60 HZ, 115V.....</i>	<i>B-4</i>
	<i>European Markets .....</i>	<i>B-5</i>
	<i>CE.....</i>	<i>B-5</i>
	<i>EN55022 .....</i>	<i>B-7</i>
	<i>Safety Extra Low Voltage Safety Approval.....</i>	<i>B-8</i>
<b>Appendix C</b>	<b><i>Printer Options .....</i></b>	<b><i>C-1</i></b>
	<i>Optional Equipment .....</i>	<i>C-2</i>

## *Safety Notes*

Your printer and the recommended consumable supplies have been designed and tested to meet strict safety requirements. Attention to the following notes will ensure the continued safe operation of your printer.

## Note, Caution and Warning Symbols

---

Throughout this User Guide, several symbols are used to emphasize useful, important and critical information. They are as follows:



*This symbol indicates particularly useful or helpful information about your printer.*



*This symbol indicates a caution against performing any action that may damage your printer or degrade performance.*



*This symbol indicates a warning against performing any action that may lead to physical injury.*

---

When used in a step, the above symbols appear smaller but are of equal importance.



# Electrical Safety

---

- Use the power cord supplied with your printer.
- Do not use a ground adapter plug to connect the printer to a power source receptacle that lacks a ground connection terminal.
- Plug the power cable directly into a properly grounded electrical outlet. Do not use an extension cord. If you do not know whether an outlet is grounded, ask an electrician to check the outlet.



***You may get a severe electrical shock if you do not connect the grounding conductors correctly.***

---

- Do not place the printer where people may step on the power cable.
- Do not place objects on the power cable.
- Do not obstruct the ventilation openings. These openings are provided to prevent overheating of the printer.



***Do not push objects into slots and openings on the printer. Making a contact with a voltage point or shorting out a part could result in fire or electrical shock.***

---

- If you notice unusual noises or odors, switch off the printer power immediately. Disconnect the power cable from the electrical outlet. Call an authorized service representative to correct the problem.
- If any of the following conditions occur, switch off the printer power immediately, disconnect the power cable, and call an authorized service representative.
  - The power cable is damaged or frayed.
  - Liquid is spilled into the printer.
  - The printer is exposed to water.
  - Any part of the printer is damaged.

The power cord is attached to the printer as a plug-in device at the back of the printer. In the event it is necessary to remove all electrical power from the printer, disconnect the power cord from the power receptacle.

# Laser Safety

---



*The use of controls or adjustments, or the performance of procedures other than those specified herein, may result in a hazardous radiation exposure.*

---

This equipment complies with all applicable safety standards. With specific regard to laser, the equipment complies with performance standards for laser products set by government agencies as a Class 1 laser product. It does not emit hazardous light; the beam is totally enclosed during all modes of customer operation and maintenance.

When performing various operator functions, you may see laser warning labels. These labels are for the service mode and are placed on or near panels or shields that require a tool for removal. These panels are not to be removed.

## Maintenance Safety

---

- Do not attempt any maintenance procedure that is not specifically described in the documentation supplied with your printer.
- Do not use aerosol cleaners. The use of supplies that are not approved may cause poor performance and could create a dangerous condition.
- Do not remove the covers or guards that are fastened with screws unless you are installing optional equipment and are specifically instructed to do so. Power should be OFF when performing these installations. Except for user installable options, there are no parts that you can maintain or service behind these covers.

# Operational Safety

---

Your printer and supplies were designed and tested to meet strict safety requirements. These include safety agency examination, approval, and compliance with established environmental standards.

Your attention to the following safety guidelines will help to ensure the continued safe operation of your printer.

- Use the material and supplies specifically designed for your printer. The use of unsuitable materials may result in poor performance and possibly a hazardous situation.
- Follow all warnings and instructions marked on, or supplied with, the printer, options and supplies.
- Place the printer in a dust free area where the temperature range is 41° F to 95° F (5° C to 35° C) and the relative humidity is 15% to 85%.
- Place the printer in an area where there is adequate space for ventilation, operation and servicing. The recommended minimal spacing is 24 in. (600 mm) in front of and behind the printer, and 8 in. (200 mm) on each side of the printer. Do not block or cover the slots and openings on the printer. Without adequate ventilation, the printer may overheat.

- Do not place the printer near a heat source.
- Do not place the printer in direct sunlight.
- Do not place the printer in line with the cold air flow from an air conditioning system.
- Place the printer on a level, solid surface with adequate strength for the weight of the machine. The base printer weight without any packaging materials is 60 pounds (27 kg).
- The printer is heavy. Exercise care in moving or relocating the printer. Follow the recommended procedure when moving the printer from one location to another.
- Do not put containers of coffee or other liquids onto the printer.



***Be careful when working in areas identified with a warning symbol. These areas may be very hot and could cause personal injury.***

---

- Frequent operation of the on/off switch is not recommended.
- Keep hands, hair, and neckties away from the exit feed rollers.
- Do not remove a media tray while printing from that tray.
- Do not open the covers while printing.
- Do not switch off the printer power while printing.
- Do not move the printer while printing.

## Ozone Safety

---

This printer produces very low (< 0.01 ppm) ozone during normal operation. The ozone produced is heavier than air, and the quantity is dependent on print volume. Providing the proper environmental parameters, as specified in the Operational Safety section of these Safety Notes, ensures that concentration levels meet safe limits.





# 1

## Getting to Know Your Printer

<i>Introduction</i> .....	1-2
<i>Printer Features</i> .....	1-3
<i>Paper Handling</i> .....	1-3
<i>Connectivity</i> .....	1-4
<i>Fonts</i> .....	1-5
<i>Resolution</i> .....	1-5
<i>Page Description Languages</i> .....	1-5
<i>Print Speed</i> .....	1-5
<i>Printer Components</i> .....	1-6
<i>Base Configuration</i> .....	1-6
<i>Internal Components</i> .....	1-7
<i>Printer Options</i> .....	1-8
<i>Printer Documentation</i> .....	1-9
<i>Printed Documentation</i> .....	1-9
<i>Product CD</i> .....	1-11
<i>Printer Management Software CD</i> .....	1-11
<i>Using the CDs</i> .....	1-10

# Introduction

---

In this chapter, you will become familiar with the features of your printer and learn where to locate specific printer parts.

Before you use your printer, make sure that you perform all of the steps outlined in the *Quick Installation Guide* that came with your printer, and connect the necessary cables.

Your printer may also have one or more optional features installed. First verify your exact equipment options before proceeding further. If you see features described in this section that are not available with the equipment you have, you can easily add them yourself. For more information, refer to the separate *Supplies/Options Guide* provided with your printer.

# Printer Features

---

Your printer has many special features that allow you to achieve the results you need for your specific print job. Features vary slightly according to the options you are using and the memory installed in your printer. This section will help you become familiar with your printer's features and capabilities.

## Paper Handling

Your printer has several paper source and paper output options as described below and in Figure 1.5 on page 1-8. For a listing of supported media types and sizes, refer to the section “*Selecting Print Media*” (page 2-2).

### Paper Sources

- The standard **multi bypass feeder** functions as either a single sheet manual feed tray or a tray for up to 150 sheets.
- **Tray 1** is the standard 500 sheet input source.
- **Tray 2** is the optional input source installed immediately below Tray 1. This may be a 500 sheet feeder or the 2,000 sheet feeder.
- **Tray 3** is the optional input source installed immediately below Tray 2. This is only available if Tray 2 is not the 2,000 sheet feeder, and may be another 500 sheet feeder or the 2,000 sheet feeder.

Trays 1, 2 and 3 all have automatic paper size sensing, low paper sensing, and paper out sensing. The multi bypass feeder has low paper sensing and paper out sensing. Refer to *Chapter 2: Loading Print Media* for instructions on loading the trays.

## Paper Output

- The standard output bin holds up to 500 sheets and receives output face down. It has bin full detection.
- The optional offset catch tray holds up to 500 sheets and receives output face down. It has offset capability, as described in the section “*Offsetting Output*” (page 3-58), and bin full detection. It does not support all media types and sizes. Refer to Table 2.1 on page 2-4 for supported media sizes.

## Duplex Printing

A duplex option is available for your printer which enables duplex (two-sided) printing on specific media types and sizes. For information on supported media, refer to Table 2.1 on page 2-4. For information on printing duplex, refer to the section “*Duplex Printing*” (page 3-59).

## Connectivity

Your printer contains the following standard interfaces for connecting to a host computer or network:

- IEEE 1284 Parallel
- Universal Serial Bus (USB)
- 10/100 Mbit 10/100baseT Ethernet

The following optional interfaces are available:

- RS-232 Serial
- 10 Mbit 10base2 Ethernet
- Token Ring

For information about supported network environments and protocols, refer to the *Technical Information Guide* on your Product CD.

## Page Description Languages

Your printer includes the following Page Description Languages (PDLs):

- An emulation of HP PCL 5e
- An emulation of HP PCL 6
- Adobe PostScript 3

## Fonts

The PCL emulation uses TrueType, Intellifont and bitmap fonts. There are 35 Intellifont fonts, 1 bitmap font and 10 TrueType fonts resident in the printer. Other fonts may be downloaded to system memory, optional Flash memory or the optional hard disk.

PostScript 3 contains 136 fonts, of which 39 are resident in the printer. The remaining fonts are available on the Product CD for downloading to system memory, optional Flash memory or the optional hard disk.

## Resolution

Your printer provides the following resolutions:

- true 1200 dots per inch (dpi)
- 1200 dpi image quality
- 600 dpi
- 300 dpi (PCL 5e only)

## Print Speed

The print speed your printer achieves depends on the model/configuration of your printer and the complexity of your print jobs. Maximum rated print speed is:

- 20 ppm for the DocuPrint N2025
- 28 ppm for the DocuPrint N2825.

# Printer Components

## Base Configuration

### Front View

- 1 Top cover and Standard output bin
- 2 Control Panel
- 3 Paper support and stopper
- 4 Multi bypass feeder (shown closed)
- 5 Tray 1
- 6 Paper amount indicator
- 7 Power switch

Figure 1.1 Printer Components, Front View

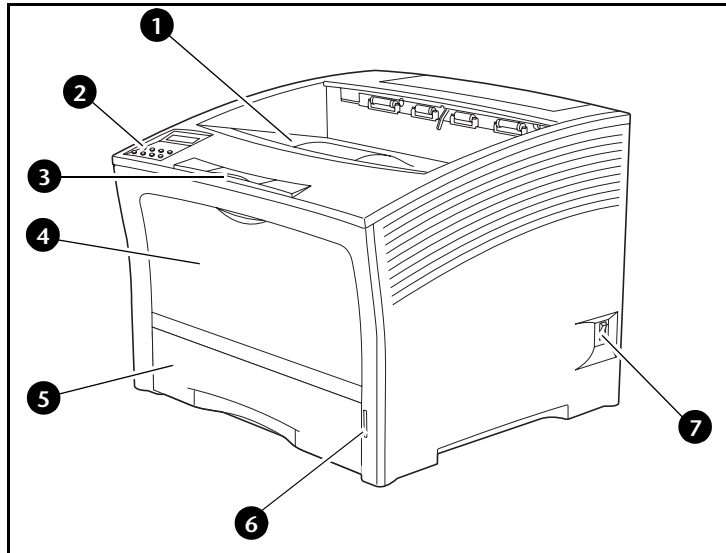

### Rear View

- 1 Rear cover (shown closed)
- 2 Power cord receptacle
- 3 Ventilation slots
- 4 Interface connectors (Parallel, USB, Ethernet)
- 5 Top cover (shown closed)

Figure 1.2 Printer Components, Rear View

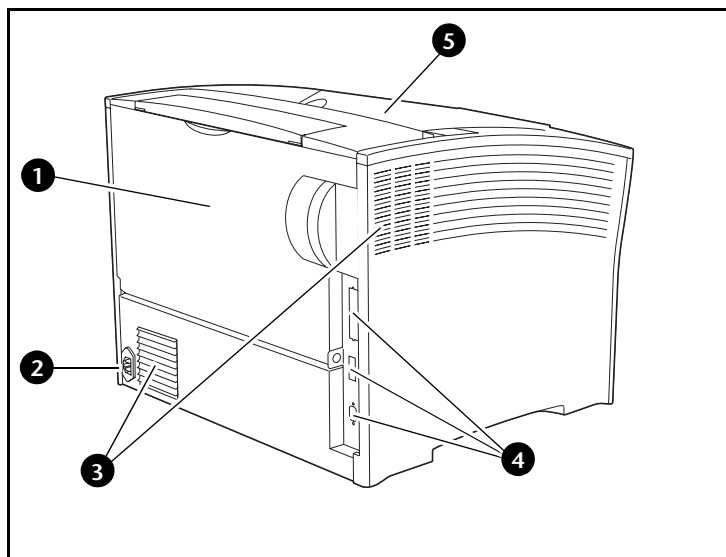

## Internal Components

Figure 1.3 Internal Components, Front View

### Front View

- 1 Top cover (shown open)
- 2 Laser print cartridge (accessed through top cover)
- 3 Multi bypass feeder (shown open)

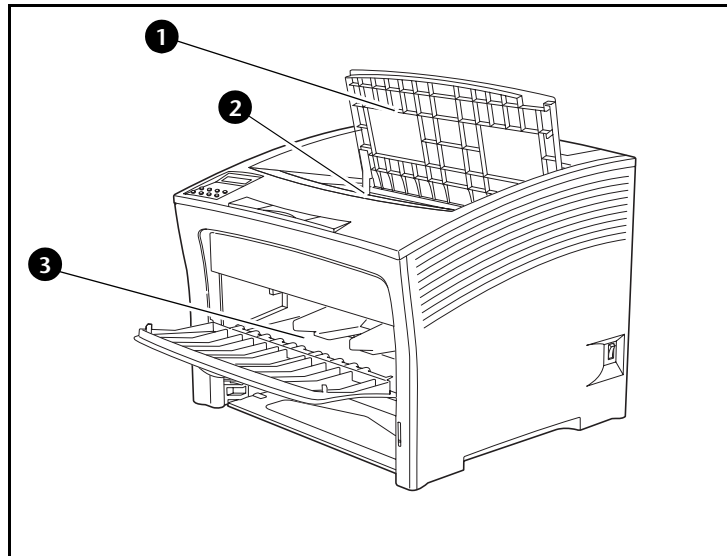
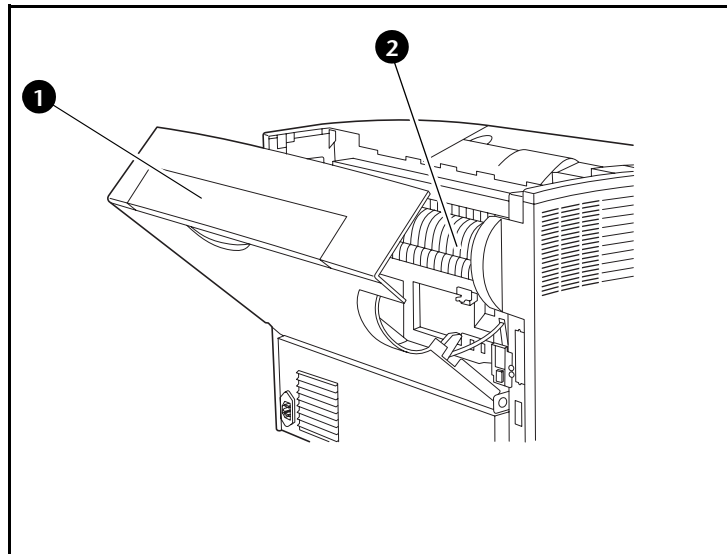

Figure 1.4 Internal Components, Rear View

### Rear View

- 1 Rear cover (shown open)
- 2 Fuser



## Printer Options

Figure 1.5 Printer Options, Front View

### Front View

- 1 Offset Catch Tray
- 2 500 sheet feeder (A3/Ledger as shown or A4/Letter, shown as Tray 2)
- 3 2,000 sheet feeder (shown as Tray 3)

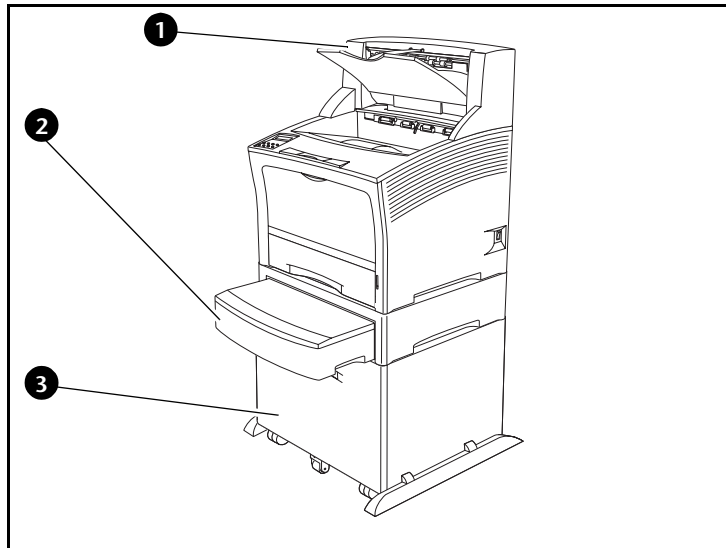
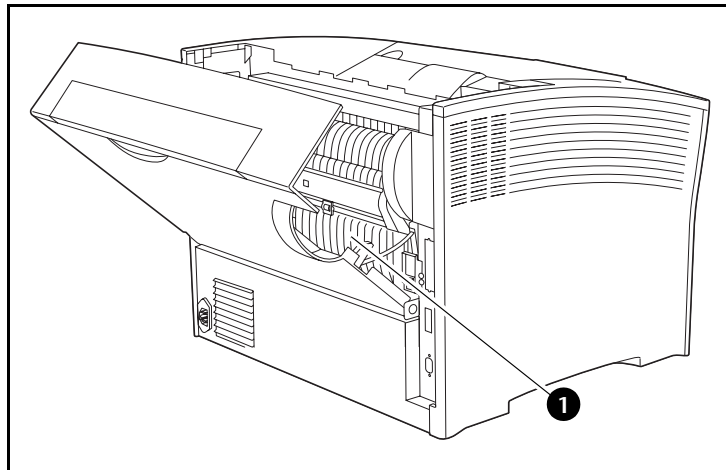

Figure 1.6 Printer Options, Rear View

### Rear View

- 1 Duplex printing unit (shown installed)





# Printer Documentation

---

Your printer is packaged with documentation in both printed form and on CD. There are two CDs:

- **Product CD**, which contains documentation and printer drivers.
- **Printer Management Software CD**, which contains various client software and the documentation for them.

This section serves as a roadmap for the printed and CD documentation.

## Printed Documentation

Your printer was packaged with the following pieces of printed documentation:

- **Quick Install Guide**, which shows you how to get your printer up and running.
- **User Guide** (this book), which provides you with the basic information needed to use your printer. (More detailed information is contained in the *System Administrator Guide* on your Product CD.)
- **Quick Network Install Guide**, which briefly shows you how to connect your printer to a network in your specific environment. (More detailed Network/Environment information is contained in the *Technical Information Guide* on your Product CD.)

## Using the CDs

The documentation on the Product CD is provided as PDF files, which are opened in Adobe Acrobat Reader (provided on the CD if you do not already have it installed). These files contain hypertext links that enable you to jump from the Table of Contents or Index directly to the page where you are looking for information, as well as from page to page where information is cross-referenced. Simply move the cursor over a hypertext link and it changes to a pointing finger. Then click on the link to jump to the link's destination.

The PDF files also enable you to print the specific pages you need, rather than printing an entire chapter or manual.

Both the Product CD and the Printer Management Software CD are provided with installation booklets in their respective jewel cases. You can also refer to the ReadMe files on the CDs for more information.

## Product CD

Your printer was also packaged with a CD that contains the following pieces of documentation as PDF files:

- **User Guide** (electronic version of this book)
- **System Administrator Guide**

The System Administrator Guide contains a considerable amount of more detailed information.

- **Supplies/Options Guide**



*Printer drivers are also contained on this CD. The majority of driver documentation is provided via the Help files included with the drivers.*

---

## Printer Management Software CD

User Guides are provided for each of the major printer management utilities. Consult the booklet enclosed with the CD for more information.



*Since both the Product CD and the Printer Management Software CD contain so much important information, please ensure that you save them and keep them in a safe place.*

---





# 2

## *Loading Print Media*

<i>Selecting Print Media</i> .....	2-2
<i>Storing Paper</i> .....	2-6
<i>Loading Paper</i> .....	2-7
<i>Tray 1, 2 or 3</i> .....	2-7
<i>A4/Letter Size Tray</i> .....	2-7
<i>A3/Ledger Size Tray</i> .....	2-10
<i>2,000 Sheet Feeder</i> .....	2-14
<i>Multi Bypass Feeder</i> .....	2-16

## Selecting Print Media

---

This chapter will help you understand what kinds of paper and other print media you can use with your printer and also how to properly position the media in the printer's various input sources. Your printer supports a variety of standard sizes as well as custom sizes.

- Table 2.1 on page 2-4 lists the standard sizes of paper, envelopes, and other print media you can use with all of your printer's input trays and output bins. Media sizes that are shown as not supported may be printed as custom sizes if the dimensions fall within the ranges shown in Table 2.2 on page 2-5.
- Table 2.2 on page 2-5 describes the custom sizes your printer will support. For information on configuring custom sizes, see the *System Administrator Guide* on the Product CD.
- The printer supports paper weights as follows:
  - 17-75 lbs. (64-200 g/m<sup>2</sup>) via paper trays
  - 17-57 lbs. (64-190 g/m<sup>2</sup>) multi bypass feeder
  - 17-28 lbs. (64-105 g/m<sup>2</sup>) with duplex
  - The optional 2,000 sheet feeder supports 18-24 lbs. (68-90 g/m<sup>2</sup>)



*Using media not recommended for laser printers may result in paper jams, print quality problems or printer damage.*

---

The following media are unacceptable for use in the printer:

- Excessively thick or thin paper
- Paper that has already been printed on (preprinted letterhead is allowed)
- Wrinkled, torn, or bent paper
- Moist or wet paper
- Curled paper
- Paper with an electrostatic charge
- Glued paper
- Paper with special coating
- Paper unable to withstand a temperature of 150° C (302° F)
- Thermal paper
- Carbon paper
- Paper with paper fasteners, ribbons, tape, etc. attached
- Heavily textured paper

**Table 2.1** Acceptable media sizes and capacities

Media Size	Input <sup>1</sup>			Multi Bypass Feeder	Output	
	Tray 1, Tray 2, Tray 3				Standard Bin	Offset Catch Tray
	A4/Letter	A3/Ledger	2,000 Sheet Feeder			
<b>A3</b> 297x420 mm	-	SEF <sup>2</sup>	-	SEF	SEF	-
<b>A4</b> 210x297 mm	LEF	LEF	LEF	LEF	LEF	LEF
<b>A5</b> 148x210 mm	LEF <sup>2</sup>	LEF <sup>2</sup>	-	LEF	LEF	LEF
<b>A6</b> 105x148 mm	-	-	-	LEF (1)	LEF	-
<b>B4-JIS</b> 257x364 mm	-	SEF	-	SEF	SEF	-
<b>B5-JIS</b> 182x257 mm	LEF <sup>2</sup>	LEF <sup>2</sup>	-	LEF	LEF	LEF
<b>Statement</b> 5.5x8.5"	LEF <sup>3</sup>	LEF <sup>3</sup>	-	LEF	LEF	LEF
<b>Executive</b> 7.25x10.5"	LEF <sup>3</sup>	LEF <sup>3</sup>	-	LEF	LEF	LEF
<b>Letter</b> 8.5x11"	LEF	LEF	LEF	LEF	LEF	LEF
<b>Folio</b> 8.5x13"	-	SEF	-	SEF	SEF	-
<b>Legal</b> 8.5x14"	-	SEF	-	SEF	SEF	-
<b>Ledger</b> 11x17"	-	SEF <sup>3</sup>	-	SEF	SEF	-
<b>Envelopes</b>						
<b>COM-10</b> 4.125x9.5"	LEF (1) <sup>3</sup>	-	-	LEF (1)	LEF	-
<b>Monarch</b> 3.87x7.5"	LEF (1) <sup>3</sup>	-	-	LEF (1)	LEF	-
<b>DL</b> 110x220 mm	LEF (1) <sup>2</sup>	-	-	LEF (1)	LEF	-
<b>C5</b> 162x229 mm	LEF (1)	-	-	LEF (1)	LEF	-
<b>Transparencies</b>						
<b>A4</b> 210x297 mm	LEF (1)	LEF (1)	-	LEF (1)	LEF	-
<b>Letter</b> 8.5x11"	LEF (1)	LEF (1)	-	LEF (1)	LEF	-
<b>Labels</b>						
<b>A4</b> 210x297 mm	LEF (1)	LEF (1)	-	LEF (1)	LEF	-
<b>Letter</b> 8.5x11"	LEF (1)	LEF (1)	-	LEF (1)	LEF	-
<b>Capacity<sup>4</sup></b>	500	500	2000	150	500	500

<sup>1</sup> SEF = Short Edge Feed, LEF = Long Edge Feed, (1) = Simplex (one-sided) printing only

<sup>2</sup> Only when Defaults=Millimeters in the Control Panel System Menu

<sup>3</sup> Only when Defaults=Inches in the Control Panel System Menu

<sup>4</sup> Maximum capacity @ 75 g/m<sup>2</sup> paper stock. Capacity is reduced for heavier/thicker stock.



**Table 2.2** Acceptable Custom Sizes

	Input				Output	
	Tray 1, Tray 2, Tray 3			Multi Bypass Feeder	Standard Bin	Offset Catch Tray
	A4/Letter	A3/Ledger	2,000 Sheet Feeder			
<b>Simplex</b>						
Width	148~297 mm 5.83~11.69 in.	210~297 mm 8.27~11.69 in.	None	76.2~305 mm 3~12 in.	76.2~305 mm 3~12 in.	210~297 mm 8.27~11.69 in.
Length	98.4~216 mm 3.875~8.5 in.	139.7~431.8 mm 5.5~17 in.	None	98.4~508 mm 3.875~20 in.	98.4~508 mm 3.875~20 in.	139.7~216 mm 5.5~8.5 in.
<b>Duplex</b>						
Width	182~297 mm 7.16~11.69 in.	210~297 mm 8.27~11.69 in.	None	182~297 mm 7.16~11.69 in.	76.2~305 mm 3~12 in.	210~297 mm 8.27~11.69 in.
Length	139.7~216 mm 5.5~8.5 in.	139.7~431.8 mm 5.5~17 in.	None	139.7~431.8 mm 5.5~17 in.	98.4~508 mm 3.875~20 in.	139.7~216 mm 5.5~8.5 in.

## Storing Paper

---

Print quality is optimized when paper and other print media are properly stored. Proper storage ensures optimum print quality and trouble-free printer options.

- Store the paper on a flat surface, in a relatively low humidity environment.
- Avoid storing paper in such a way as to cause wrinkling, bending, curling, etc.
- Do not unwrap paper until you are ready to use it, and rewrap any paper you are not using.
- Do not expose paper to direct sunlight or high humidity.

# Loading Paper

## Tray 1, 2 or 3 A4/Letter Size Tray

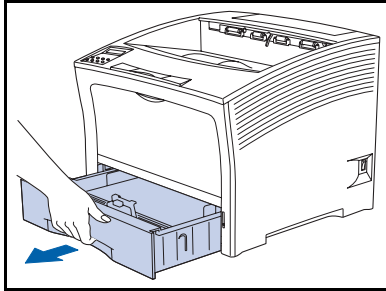

- 1 Remove the tray from the printer and place it on a flat surface.



*To remove the tray from the printer, pull it out until it stops, then gently remove it from the printer while lifting it up.*

If you are replenishing paper of the same size, there is no need to adjust the tray's length and width guides. You can therefore skip those steps that call for these adjustments.

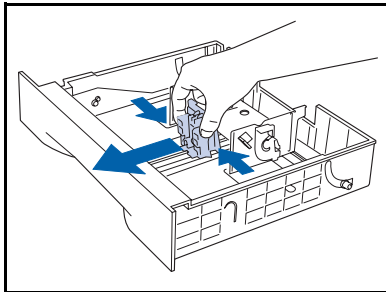

- 2 Gently squeeze the length guide, lift it up and slide it all the way out.

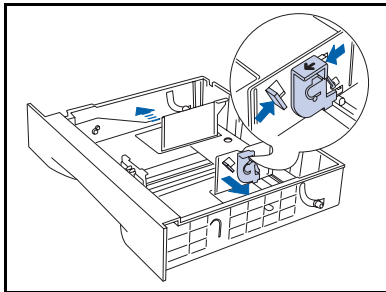

- 3 Gently squeeze the side guides and slide them all the way out.

## Loading Paper

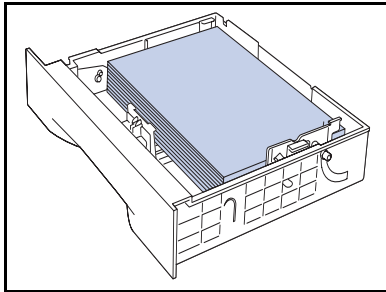
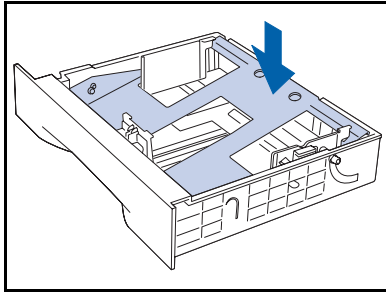

**4** If the tray's metal base plate remains raised, press it down to lock it.

**5** Align the four corners of the paper stack and insert it into the tray with the side to be printed on facing up (see illustration, below, for orientation of letterhead, drilled paper, transparencies and envelopes). Make sure the paper is placed at the center of the tray, under the retaining clips on both sides.



*To reduce the possibility of misfeeds and jams, especially when using special stock, fan the stack of paper before inserting it into the tray.*

**1** Simplex orientation

**2** Duplex orientation

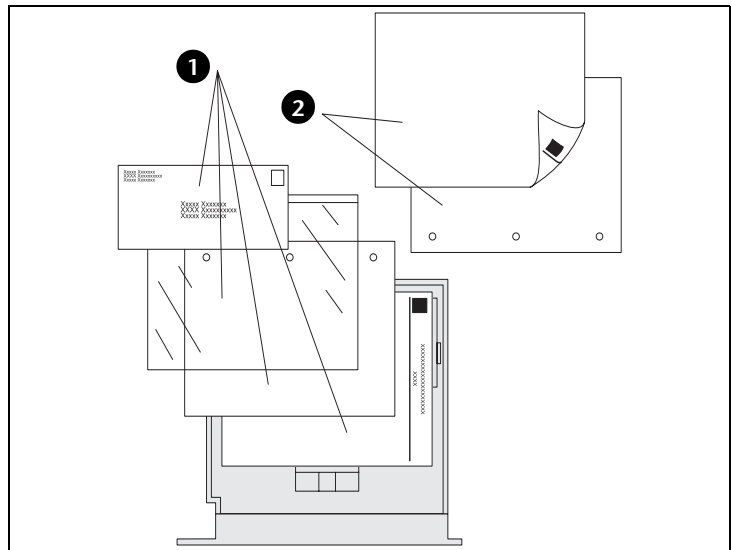

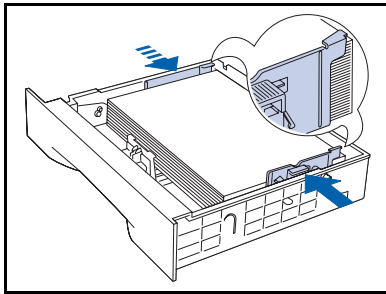

- 6 While pressing the side guides, adjust them to the paper width.



*To avoid misfeeds and jams, make sure the stack is under the retaining clips on both sides and adjust the side guides to the paper size correctly.*

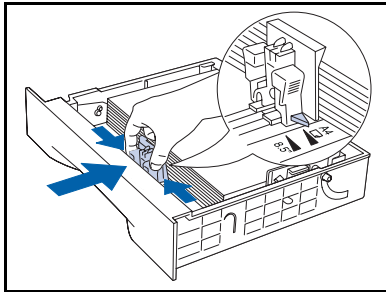

- 7 When the side guides are aligned, adjust the length guide to the paper length.

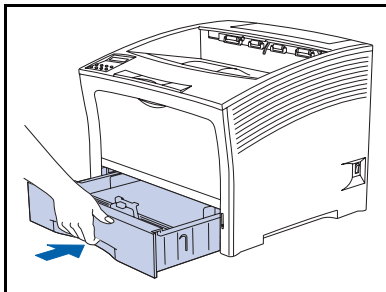

- 8 Insert the tray completely into the printer. Make sure it is properly seated.

## A3/Ledger Size Tray

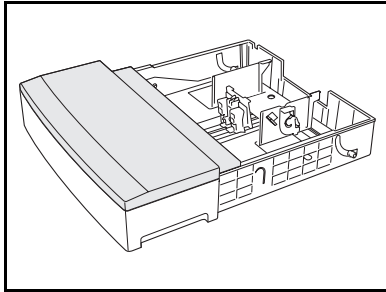

- 1 Remove the tray from the printer and place it on a flat surface.



*To remove the tray from the printer, pull it out until it stops, then gently remove it from the printer while lifting it up.*

If you are replenishing paper of the same size, there is no need to adjust the tray's length and width guides. You can therefore skip those steps that call for these adjustments.

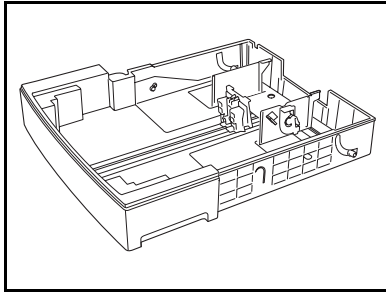

- 2 Remove the tray cover.

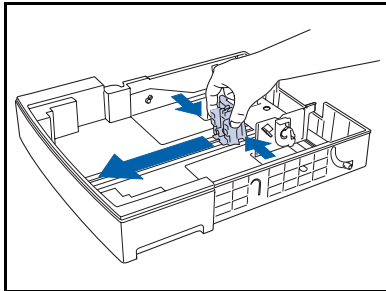

- 3 Gently squeeze the length guide, lift it up and slide it all the way out.

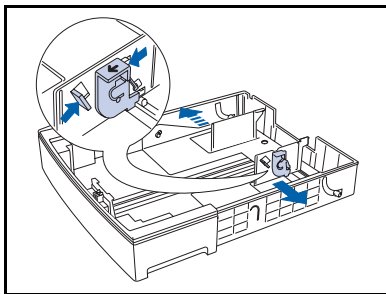

- 4 Gently squeeze the side guides and slide them all the way out.

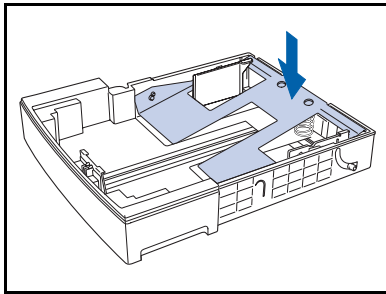

**5** If the tray's metal base plate remains raised, press it down to lock it.

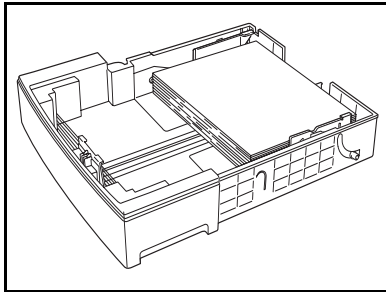

**6** Align the four corners of the paper stack and insert it into the tray with the side to be printed on facing up (see illustration, below, for orientation of letterhead, transparencies and drilled paper). Make sure the paper is placed at the center of the tray, under the retaining clips on both sides.



*To reduce the possibility of misfeeds and jams, especially when using special stock, fan the stack of paper before inserting it into the tray.*

**1** Simplex orientation

**2** Duplex orientation

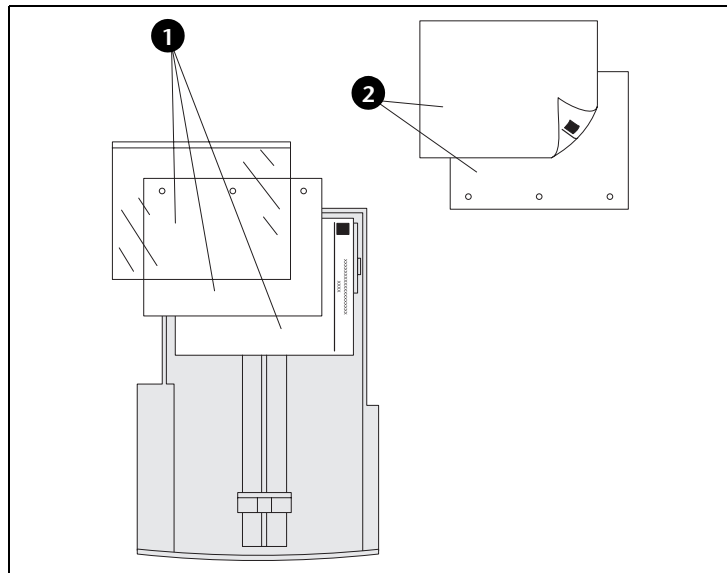

## Loading Paper

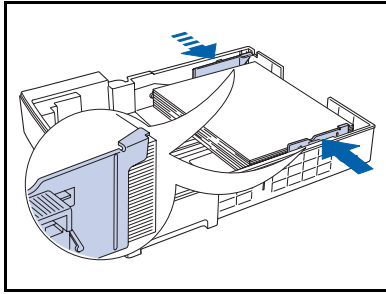

- 7** While pressing the side guides, adjust them to the paper width.



*To avoid misfeeds and jams, make sure the stack is under the retaining clips on both sides and adjust the side guides to the paper size correctly.*

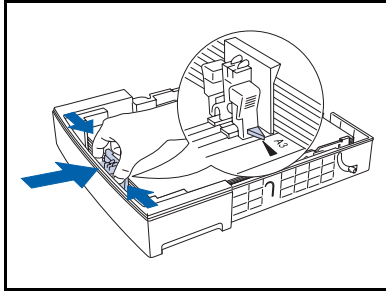

- 8** When the side guides are aligned, adjust the length guide to the paper length.

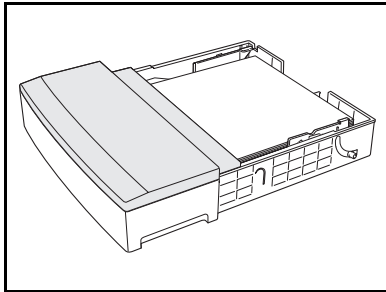

- 9** Replace the tray cover.

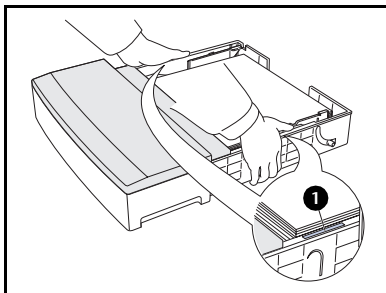

- 10** Hold the tray at the green labels (1) and insert it into the printer.



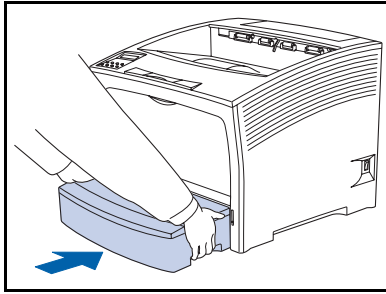

- 11** Push the tray completely into the printer. Make sure it is properly seated.

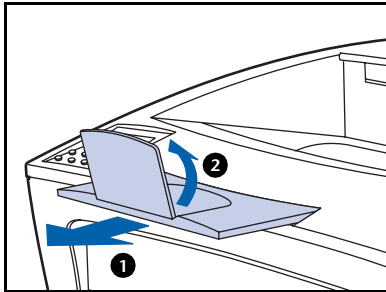

- 12** When using large-size media:
- 1** Pull out the paper support.
  - 2** Lift up the stopper.

## 2,000 Sheet Feeder

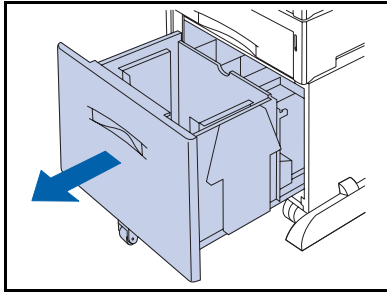

- 1 Pull out the tray until it stops.



**Do not reach into the tray with your hand until the tray's base is completely lowered.**

If you are replenishing paper of the same size, there is no need to adjust the tray. Skip to Step 3.

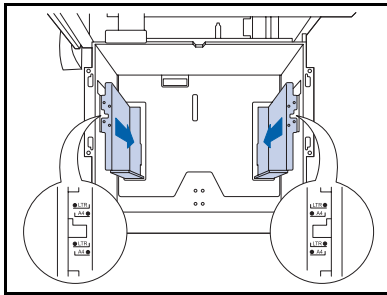

- 2 Adjust the paper guides to the size of the paper by opening the release tabs and inserting them into the desired guide holes.

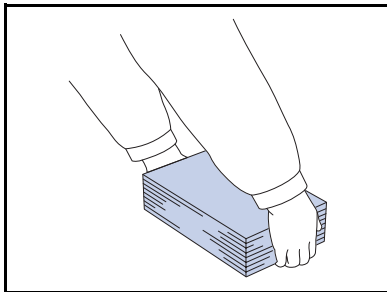

- 3 Prepare to load a stack of paper into the tray by holding it with both hands as shown.

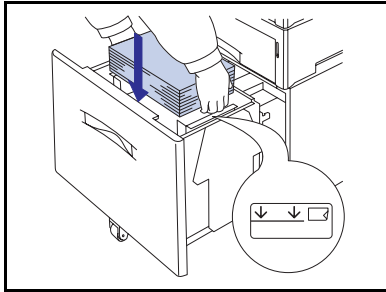

- 4** Gently load the stack of paper into the tray (see illustration, below, for orientation of letterhead and drilled paper).

 ***Make sure the stack does not exceed the maximum level indicator on the tray.***

- 1** Simplex orientation
- 2** Duplex orientation

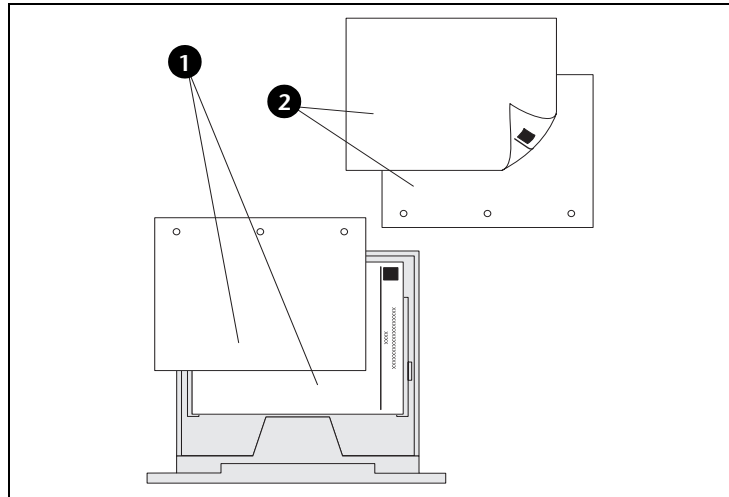

- 5** Push the tray all the way back into the feeder.

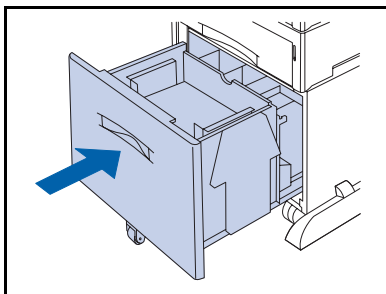

## Multi Bypass Feeder

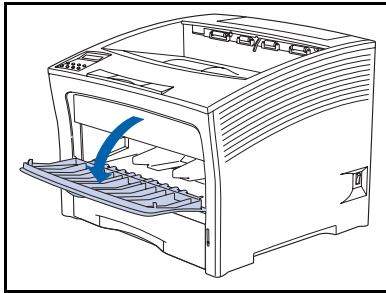

- 1 Open the multi bypass feeder door by pulling the latch at the top center.



**To prevent possible damage to the multi bypass feeder, do not exert strong pressure on it or place any heavy objects on it.**

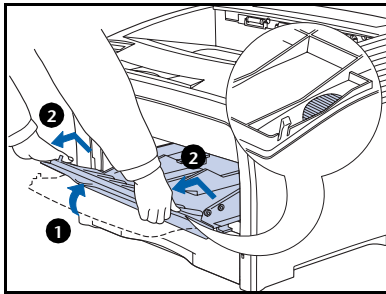

- 2 If you intend to load envelopes, postcards or other small-size paper, you need to extend the multi bypass feeder.

- 1 Hold both sides of the multi bypass feeder where indicated.

- 2 Gently lift the multi bypass feeder and pull it out towards you until it stops.

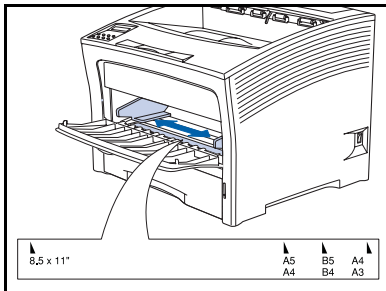

- 3 Adjust the paper guide to fit the media you intend to use.



**To prevent possible jams, be sure to adjust the guides correctly and do not overload the tray.**

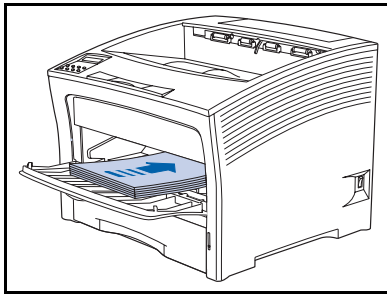

- 4** Align the four corners of the paper and place it into the tray with the side to be printed facing up (see illustrations, below, for orientation of letterhead, drilled paper, transparencies and envelopes).



*Be sure to insert the paper all the way in until it gently touches the stopper inside the printer.*

**Long Edge Feed Orientation**

- 1 Simplex orientation
- 2 Duplex orientation
- 3 Envelope orientations

**Short Edge Feed Orientation**

- 1 Simplex orientation
- 2 Duplex orientation

## Loading Paper

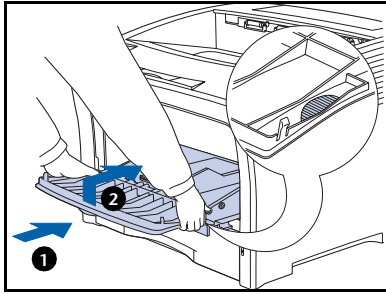

**5** If you extended the multi bypass feeder in Step 2, return it to its normal position:

Hold both sides of the multi bypass feeder where indicated and push it straight back into the printer until it stops.

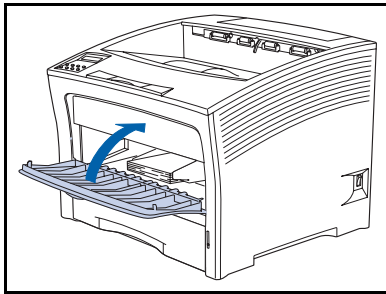

**6** the door can be closed when the media fits within the multi bypass feeder enclosure.

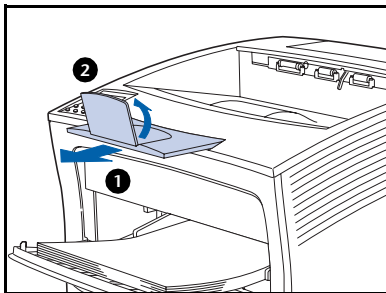

**7** When using large-size media:

**1** Pull out the paper support.

**2** Lift up the stopper.



# 3

## Printing

<i>Introduction</i> .....	3-3
<i>Using the Printer Drivers</i> .....	3-4
<i>Installing the Printer Drivers</i> .....	3-5
<i>Configuring the Printer Drivers</i> .....	3-5
<i>Using the Driver's Features</i> .....	3-6
<i>Using the PCL Driver</i> .....	3-7
<i>Paper/Output</i> .....	3-8
<i>Document Options</i> .....	3-12
<i>Graphics Options</i> .....	3-15
<i>Watermarks</i> .....	3-19
<i>Overlays</i> .....	3-20
<i>Using the PostScript Driver</i> .....	3-21
<i>Paper/Output</i> .....	3-21
<i>Document Options</i> .....	3-26
<i>Image Options</i> .....	3-28
<i>Fonts</i> .....	3-31
<i>PostScript</i> .....	3-33
<i>Using the Control Panel</i> .....	3-35
<i>The Display</i> .....	3-36
<i>The Indicator Lights</i> .....	3-37

<i>The Keys</i> .....	3-38
<i>Menu Options</i> .....	3-40
<i>Printing a Password Job</i> .....	3-55
<i>Deleting a Password Job</i> .....	3-56
<i>Generating a Printer Report</i> .....	3-57
<i>Offsetting Output</i> .....	3-58
<i>Duplex Printing</i> .....	3-59
<i>Configuring Custom Paper Sizes</i> .....	3-61
<i>Special Media Printing</i> .....	3-63



# Introduction

---

This chapter provides information on:

- Using printer drivers to control the printer's output.
- The features of the printer's Control Panel, and using it to generate printer reports such as the Configuration Sheet.
- Offsetting and duplicating.
- Printing using custom paper size and special media such as heavier stock and labels.

For information on networking-specific printing issues and printer management software, refer to the documentation on the printer management software CD.

## Using the Printer Drivers

Your printer offers many special features that are designed to produce the highest quality black and white prints while giving you the flexibility you need to print a variety of documents. These features are accessed through the printer drivers.

The way these features are accessed depends on both the printer driver that you are using and your operating system.

Your printer supports the PCL printer drivers listed in Table 3.1 and the PostScript printer drivers listed in Table 3.2 on page 3-5. To take full advantage of all the printer's features when printing PCL or PostScript jobs, install the appropriate printer driver(s).

**Table 3.1 PCL 5e and PCL 6 Emulation printer drivers<sup>1</sup>**

Environment	Printer Driver
Windows	Windows 95/98 Windows 2000 Windows NT 4.0

<sup>1</sup> For Windows 3.1, use a generic driver, or obtain a driver from your customer support center. Note that certain features will not be available in Windows 3.1

Table 3.2 PostScript Printer Drivers<sup>1</sup>

Environment	Printer Driver
Windows	Windows 95/98 Windows 2000 Windows NT 4.0
IBM OS/2	OS/2 Ver. 2.1 OS/2 WARP
Macintosh	System 7.x, 8.x
UNIX (Sun Solaris, Sun OS, SCO UNIX, IBM AIX, HP-UX, DEC)	Sun Solaris 2.5, 2.5.1, 2.6 IBM AIX 4.2.x, 4.3.x HP-UX 10.x, 11.x SGI 6.2, 6.4 DEC 4.0 UNIXWare 7.0

<sup>1</sup> For Windows 3.1, use a generic driver, or obtain a driver from your customer support center. Note that certain features will not be available in Windows 3.1

## Installing the Printer Drivers

Inside the cover of the product CD's case is a booklet with instructions on how to load your printer drivers. In addition, your System Administrator can download drivers directly to your workstation.

## Configuring the Printer Drivers

When you initially use any of your printer drivers, make sure to properly configure them for the printer and its installed options (such as the hard drive, High Capacity Feeder, etc.). These settings are displayed under the driver's "Printer Configuration" tab. If you are not certain which options your printer will support, you can check by printing a Configuration Sheet at the printer's Control Panel, as described in the section "Generating a Printer Report" (page 3-57).

## Using the Driver's Features

At a minimum, your printer's drivers enable you to control the following aspects of printing:

- Select an input tray from which to draw paper or other print media.
- Select an output bin to which the print job will be delivered.
- Select simplex or duplex operation (if the duplex option is installed).
- Select paper size, orientation and media.
- Select the number of copies.
- Select collating.

The following sections provide a general overview of many features supported by your printer's drivers. Note that some features may not be supported by some of the drivers.

## Using the PCL Driver

---

Your printer's PCL 5e and PCL 6 drivers are controlled by a dialog window that contains various tabs. Selecting a tab changes the dialog window to display controls related to the selected tab. The following is a general overview of the driver's features, organized by its dialog window tabs.



*For more complete descriptions of the drivers and their functionality, use the driver's online help. Actual driver capabilities can be determined by invoking the specific drivers.*

---

## Paper/Output

When you select this tab, you can select a job type, copies, paper, image orientation, duplex, document collation and output bin for your printer.

### Job Type

There are three job types. Some job types require a password.

- Normal Print

Spools and prints the job with no user intervention needed.

- Secure Print (available when optional hard drive is installed)

Defers printing of a job until you enter the matching password on the Control Panel.

To use this feature, enter a 4-digit numeric password, where each digit can be any numeric value between 0 and 7. Releasing the job at the printer is discussed in the section *"Printing a Password Job"* (page 3-55). You can also choose to delete the job without printing it, as described in the section *"Deleting a Password Job"* (page 3-56).

- Proof Print (available when optional hard drive is installed)

Used when user wishes to proof one copy before printing multiple copies. The user assigns a password and copy count in the driver before printing. One proof copy is printed immediately for review by the user and the remaining copies reside on the printer's Hard Disk. At this time, the user has the ability to print the remaining copies or delete the print job without printing by entering a password in the printer's Control Panel.

E.g. User selects three copies to print using proof print. One copy is printed immediately without password for review. When accepted user enters password at printer's control panel, three copies are printed.

To use this feature, specify the number of copies to be printed, then enter a 4-digit numeric password, where each digit can be any numeric value between 0 and 7. Releasing the job at the printer is discussed in the section *"Printing a Password Job"* (page 3-55). You can also choose to delete the job without printing the remaining sets, as described in the section *"Deleting a Password Job"* (page 3-56).

## Copies

You can choose to print from one to 999 copies. The default is one copy.

## Select Paper

You can select paper size, media type and input source for All Pages, for the First Page (if different than the rest of the job), and for Separators (if desired).

Selecting Proof Print causes one set to print immediately without the password.

## Duplex

Requires installation of the optional Duplex Module. For more information, see the section “*Duplex Printing*” (page 3-59). The options are:

- Duplex Off  
Single sided printing. This is the default setting.
- Duplex with Short-Edge Binding  
Double sided printing so that the pages turn about the shortest edge of the paper.
- Duplex with Long-Edge Binding  
Double sided printing so that the pages turn about the longest edge of the paper.

## Image Orientation

Orientation refers to the direction of print on the page. The options are:

- Portrait  
A Portrait page is taller than it is wide. This is the default setting.
- Landscape  
A Landscape page is wider than it is tall.



## Document Collation

Allows job collation (for multiple-copy jobs only). The options are:

- Uncollated (the default setting)

For example, five uncollated copies of a three-page job will result in five copies of page 1, then five copies of page 2, and finally five copies of page 3; that is: 1, 1, 1, 1, 1, 2, 2, 2, 2, 2, 3, 3, 3, 3, 3.

- Collated

Use this option when you want to print two or more separate sets of a job that contains two or more pages. For example, five collated copies of a three-page job will result in one set of all three pages in order, then a second set of all three pages in order, then a third set of all three pages in order, and so on; that is: 1, 2, 3, 1, 2, 3, 1, 2, 3, 1, 2, 3, 1, 2, 3.

Certain print jobs are always collated. These are Proof jobs, discussed under “*Job Type*” (page 3-8) or jobs that request more than one copy of a multiple-page job with page separators, discussed under “*Select Paper*” (page 3-10).

## Output

Allows you to set your printer's paper output destination. The options are:

- The Standard Bin, which holds up to 500 sheets.
- The optional offset catch tray, which holds up to 500 sheets of standard paper with offset capability.

Use this feature (available only when the optional Offset Catch Tray is installed) to offset the output of successive jobs (or sets within a multiple set job) from each other. For more information on offsetting output, see the section *"Offsetting Output"* (page 3-58).

## Document Options

When you select this tab, you can set the finishing mode and margins.

### Finishing Mode

There are two finishing modes:

- Multiple Pages per Side (N-Up printing)

By default, the printer will print one page image on the sheet of paper. You can select two, four, six, nine or sixteen page images per side of paper. The printer will shrink the page images as needed and will arrange them on the paper most appropriately for the paper size and orientation.

You can also choose to print black borders around each page. The default is to not print borders.

- Booklet Printing

The driver will print the document as two images per sheet, landscape orientation. However, it rearranges the page images so the sheet of paper can be folded to be read as a left-to-right book.

The standard booklet format has the first page as the left-most page. The Right-to-Left control, if checked, will print the booklet with the first page as the right-most page.

On a folded sheet of paper with two page images, the horizontal distance from the fold to either page image is called the gutter. The Gutter control allows you to set this distance to zero, fifty, one hundred, or 150 dots.

When you fold several pages into a booklet, the thickness of the paper forces the page image of the inner pages to shift slightly outward. The Creep control allows you to choose a number of dots by which to shift the page images inward to compensate for the thickness of the paper. You can choose any value from zero to twenty.

## Margins

Your printer can print with predefined margins, or can print all the way to the edge of the paper. The two options available are:

- Yes

If you choose this option, the printer defaults to HP compatible printable areas for each paper size, which is approximately one-sixth of an inch unprintable margins on all edges. The application may increase the margins to greater than this minimum.

- No

If you choose this option (the default setting), the printer will print all the way to the edge of the paper.

## Graphics Options

When you select this tab, you can set the various graphics options for the driver.

### Gray Scale

Gray Scale (also known as Half Tone) refers to a type of pattern that is applied to printed images. By using combinations of black dots, these patterns produce a gray appearance on the printed page. The best way to choose a Halftoning setting for your graphic image is to experiment. Print a graphic image at each setting and choose the one you like best.

The Windows 95/98 driver provides the following options:

- **Photographic Images (the default setting)**  
Use this setting for printed images that you want to have a smooth, realistic and photographic appearance. It provides soft contrasts between various shades of gray (and also works well for images originally designed with color).
- **Line Art Images**  
Choose this setting for graphic images with intricate lines and fine detail, like clip art graphics. It provides solid lines and sharp contrasts between shaded areas.
- **Scanned Images**  
Choose this setting if your graphic images were originally scanned in through a scanner. It is specially tuned to provide exceptional quality and clarity to printed images originally scanned with a scanner.

The Windows NT 4.0 driver provides more controls for adjusting contrast, brightness, gamma, etc.

- All text to Black

This option determines how the driver will print any colored text in the document. If enabled, the driver renders all text into black, no matter what color it appears on the screen. Otherwise the driver renders colored text in different shades of gray (the default setting).

## TrueType Options

Allows you to select options associated with the use and printing of TrueType fonts. The options are:

- Download as TrueType (the default)

The whole character set for each TrueType font contained on the page is sent down to the printer in an outline form. Use this option if the document uses only a small number of TrueType fonts and you wish to optimize text-printing performance.

- Download as Bit Image

Each TrueType character will be sent as an individual bitmap download font on a least-recently-used basis. As the printer driver builds up the page, new font bitmaps are sent down. When a character is used again, the bitmap is automatically selected from the one previously downloaded to printer memory. From the memory setting, the driver monitors the amount of available memory to determine when to delete font bitmaps that have not been used for some time.

- Download Graphics and device fonts

This option is useful if you want to print graphic images over TrueType text. TrueType text is always sent to the printer last, so it will always appear on top of any graphics. Selecting this option sends your TrueType images to the printer as graphic images, so the text can be obscured by graphic objects. This option is only available if you have selected the Raster setting in the Graphics Mode box, as described under “*Graphics*” (page 3-18).

- Use Printer TrueType Fonts

Determines whether to use the TrueType fonts that reside on the printer or to download TrueType fonts from the computer. If enabled (the default setting), the driver will use the TrueType fonts resident on the printer, and if your document uses fonts that do not reside on the printer, the driver will download the fonts with the job. If disabled, the driver will always download TrueType fonts to the printer with each job, even if the fonts reside on the printer already.

## Graphics

Your printer will print graphics as either raster images or as vector graphic images. All graphics can be printed as raster images. However some geometric shapes or patterns, and all TrueType fonts, print faster if they are printed as vector images.

- Vector

If selected, the driver will send as many graphics as possible as vector images, and the rest as raster images. With this setting, it is not possible to print TrueType fonts as graphic images, since TrueType fonts are vector images by default.

- Raster

When you select this setting, the driver will convert all vector images and send them to the printer as raster images. Use this setting if you want to print TrueType fonts as graphics, as described under “*TrueType Options*” (page 3-16).

## Resolution

The printer supports the following resolutions:

- True 1200 dots per inch (dpi)
- 1200 dpi image quality
- 600 dpi
- 300 dpi (PCL 5e only)



## Image Quality

The following options are available at 600 dpi resolution only and not simultaneously:

- Draft Mode  
Reduces the amount of toner placed onto the paper. Using this feature will cause pages to be printed lighter.
- XIE  
A smoothing algorithm applied to text and line art images in order to improve image quality.

## Watermarks

Use this feature when you want your output to contain background text, independent of that provided by the printing application, across the first page or every page of a document. The driver enables you to specify the text, its font, size, position on the page and rotation angle, and you can save it for use on any document.

## Overlays

A Page Overlay is a partial document that the driver can merge with your print job, producing a printed image that includes elements of both the overlay and your document. Overlays are most useful for creating such things as company letterhead. You can create the letterhead in your application as a page overlay, then download it and store it in the printer. Whenever you want to print a document with the overlay, you just send the print job to the printer with the Overlay command, and the printer will automatically print the letterhead on each page of your document. Page overlays eliminate the need to download the same information more than once, thus saving transmission time. However, they do use up printer memory or disk space.

An overlay differs from a watermark in these respects:

- An overlay can contain graphics and text in any number of fonts in any number of sizes and colors. A watermark can contain only text of one font, one size and one color.
- An overlay is usually on the margins of a page or a form, while a watermark is usually in the middle of a page.
- An overlay may use space on the printer's hard disk, but a watermark does not.

# Using the PostScript Driver

---

## Paper/Output

When you select this tab, you can select a job type, copies, paper, image orientation, duplex, document collation and output bin for your printer.

## Job Type

There are three job types. Some job types require a password.

- Normal Print

Spools and prints the job with no user intervention needed.

- Secure Print

Defers printing of a job until you enter the matching password on the Control Panel. It is only available when the optional hard drive is installed.

To use this feature, enter a 4-digit numeric password, where each digit can be any numeric value between 0 and 7. Releasing the job at the printer is discussed in the section *"Printing a Password Job"* (page 3-55). You can also choose to delete the job without printing it, as described in the section *"Deleting a Password Job"* (page 3-56).

- **Proof Print**

Used with multiple copy jobs, prints first set, then holds the other copies until you enter the matching password on the Control Panel. It is only available when the optional hard drive is installed.

To use this feature, specify the number of copies to be printed, then enter a 4-digit numeric password, where each digit can be any numeric value between 0 and 7. Releasing the job at the printer is discussed in the section *"Printing a Password Job"* (page 3-55). You can also choose to delete the job without printing the remaining sets, as described in the section *"Deleting a Password Job"* (page 3-56).

## Copies

You can choose to print from one to 999 copies. The default is one copy.

## Select Paper

You can select paper size, media type and input source for All Pages, for the First Page (if different than the rest of the job), and for Separators (if desired).

## Duplex

Requires installation of the optional Duplex Module. For more information, see the section “*Duplex Printing*” (page 3-59). The options are:

- Duplex Off  
Single sided printing. This is the default setting.
- Duplex with Short-Edge Binding  
Double sided printing so that the pages turn about the shortest edge of the paper.
- Duplex with Long-Edge Binding  
Double sided printing so that the pages turn about the longest edge of the paper.

## Image Orientation

Orientation refers to the direction of print on the page. The options are:

- Portrait  
A Portrait page is taller than it is wide. This is the default setting.
- Landscape  
A Landscape page is wider than it is tall.

## Document Collation

Allows job collation (for multiple-copy jobs only). The options are:

- Uncollated (the default setting)

For example, five uncollated copies of a three-page job will result in five copies of page 1, then five copies of page 2, and finally five copies of page 3; that is: 1, 1, 1, 1, 1, 2, 2, 2, 2, 2, 3, 3, 3, 3, 3.

- Collated

Use this option when you want to print two or more separate sets of a job that contains two or more pages. For example, five collated copies of a three-page job will result in one set of all three pages in order, then a second set of all three pages in order, then a third set of all three pages in order, and so on; that is: 1, 2, 3, 1, 2, 3, 1, 2, 3, 1, 2, 3, 1, 2, 3.

Certain print jobs are always collated. These are Proof jobs, discussed under “*Job Type*” (page 3-8) or jobs that request more than one copy of a multiple-page job with page separators, discussed under “*Select Paper*” (page 3-10).

## Output

Allows you to set your printer's paper output destination. The options are:

- The Standard Bin, which holds up to 500 sheets.
- The optional Offset Bin, which holds up to 500 sheets of paper with offset capability. Refer to Table 2.1 on page 2-4.

Use this feature (available only when the optional Offset Catch Tray is installed) to offset the output of successive jobs (or sets within a multiple set job) from each other. For more information on offsetting output, see the section *"Offsetting Output"* (page 3-58).

## Document Options

When you select this tab, you can set the driver's page size policy.

### Page Size Policies

Page Size Policies are used to specify the recovery policy when the page size cannot be matched with any available media. The options are:

- Use printer default

Use whatever Paper Size Policy that has been set on the printer as its default. This is the default paper size policy.

- Generate error if paper not available
- Ignore size and use default paper tray
- Nearest available size, adjust page

Selects the nearest available paper size and adjust the page to fit.

- Next larger available size, adjust page

Selects the next larger available paper size and adjust the page to fit.



- Nearest available size, no page adjust  
Selects the nearest paper size, but does not adjust the page to fit.
- Next larger available size, no page adjust  
Selects the next larger available paper, but does not adjust the page to fit.

## Page Layout

By default, the printer will print one page image on the sheet of paper. You can select two, four, six, nine or sixteen page images per side of paper. The printer will shrink the page images as needed and will arrange them on the paper most appropriately for the paper size and orientation.

You can also choose to print black borders around each page. The default is to not print borders.

## Watermarks

When you select this tab, you can create watermarks.

Use this feature when you want your output to contain background text, independent of that provided by the printing application, across the first page or every page of a document. The driver enables you to specify the text, its font, size, position on the page and rotation angle, and you can save it for use on any document.

## Image Options

When you select this tab, you can set the various graphics options for the driver.

### Brightness

This slider control increases or decreases the brightness level of the image. The default setting is zero.

### Reduce/Enlarge

This slider control makes the page image smaller or larger by adjusting the percentage from 25% to 400%. The default is 100%. The image is anchored in the upper left corner of the paper. If you enlarge the image, the driver clips the right side and the bottom of the image to the size of the paper on which the image is to be printed. If you shrink the image, there will be white space on the right side and bottom.

## Image Modes

There are four image modes. You can choose all at the same time.

- Negative Image

This option converts the black image areas in the original to white, the white image areas to black, and any dark gray image areas to light gray. Printing a negative image may be useful for documents that have a substantial amount of dark background and/or light text and images. Note that excessive use of the Negative Image option can cause premature toner depletion and possible printer damage.

- Mirror Image

This option flips the image orientation 180 degrees, thereby reversing the image and all associated text.

- Xerox Image Enhancement (XIE)

XIE smooths text and line art images in order to improve image quality. It is available only when the Resolution is set to 600x600 dpi and Draft Mode is disabled.

- Fax Friendly Black

This feature changes your color document to patterns of black and white. The different colors are rendered as distinguishable black and white patterns. For example, a pie chart which contains wedges of different solid colors will be printed with a different pattern replacing each color so that the distinction between the pieces is maintained. Colored text is also rendered as a pattern, but the character is outlined. Anything that is black in your document remains black and is not rendered as a pattern.

## Resolution

The printer supports the following resolutions:

- True 1200 dots per inch (dpi)
- 1200 dpi image quality
- 600 dpi
- 300 dpi (PCL 5e only)

## Draft Mode

This feature reduces the amount of toner placed onto the paper. Using this feature will cause pages to be printed lighter. It is available only at 600x600 resolution and XIE is disabled.

**Fonts** When you select this tab, you can control how PostScript interprets TrueType fonts.

### TrueType Fonts

This feature offers the following options:

- Use Substitution Table

The Substitution Table helps you select a printer-resident PostScript font that is the closest match for the True Type font being generated by the application.

- Always Send to Printer

This option will send the font down to the printer as part of the job. If the Font Substitution Table or Use Printer Fonts options are not selected, the font format must be specified in the Always Send to Printer field.

## Send As

This feature contains four options:

- Outlines (Type 1)  
A scaleable, vector-based font that defines each character as a set of instructions that specify the shape and size of the character
- Bitmap (Type 3)  
A non-scaleable, rasterized format that contains data for each pixel that makes up each character. Large, complex bit maps require considerably more memory and processing time than other formats
- TrueType (Type 42)  
Scaleable, vector-based fonts developed by Apple Computer Corporation and is also used by Microsoft in their Windows operating system.
- Don't Send  
Do not send the fonts with the print job.

## Printer Font Substituted For: <font name>

This feature enables you to select which PostScript printer font you wish to substitute for the selected TrueType font.

## PostScript

When you select this tab, you can set various PostScript output options.

### Format

There are two different formats:

- Faster PostScript (Standard) (the default setting)

This setting allows you to send PostScript jobs using the standard PostScript commands.

- More Portable PostScript (ADSC)

When this option is selected, the driver creates a file that is compatible with Adobe Document Structuring Convention (ADSC). (In order to print a document to a DSC file, you must specify a file name and specify FILE as the printer port within the Printers / Connect dialog box of the Windows Control Panel.)

### PostScript Level Selection

- Include Level 3 Features

This setting allows you to send PostScript jobs using the Level 2 PostScript plus all of the additional Level 3 commands.

- Use Only Level 2 Features

This setting allows you to send only PostScript Level 2 jobs. No Level 3 commands will be accepted.

## Compress Bitmaps

This control is available only if you have selected to Use Only Level 2 Features. It compresses the graphics in your documents before sending them to the printer. Although this saves memory, the job may take longer to print. The default for this option is On.

## Print Postscript Error Information

If you choose this option, the driver will print an error sheet when an error occurs during the formatting or processing of a job. The error sheet indicates the page where the error occurred and the type of error. The default for this option is Off.



# Using the Control Panel

The printer's Control Panel (Figure 3.1) serves several purposes:

- It displays information about the status of the printer (or the job in process).
- It provides the means for changing printer settings to control how the printer operates.
- It allows you to print reports and password-protected pages stored on the optional hard drive.

**Figure 3.1 Control Panel<sup>1</sup>**

- 1 The display
- 2 Online indicator light
- 3 Form Feed indicator light
- 4 Fault indicator light
- 5 Data indicator light
- 6 Online key  
Password #0
- 7 Enter key  
Password #4
- 8 Menu Up key  
Password #1
- 9 Menu Down key  
Password #5
- 10 Item Up key  
Password #2
- 11 Item Down key  
Password #6
- 12 Value Up key  
Password #3
- 13 Value Down key  
Password #7

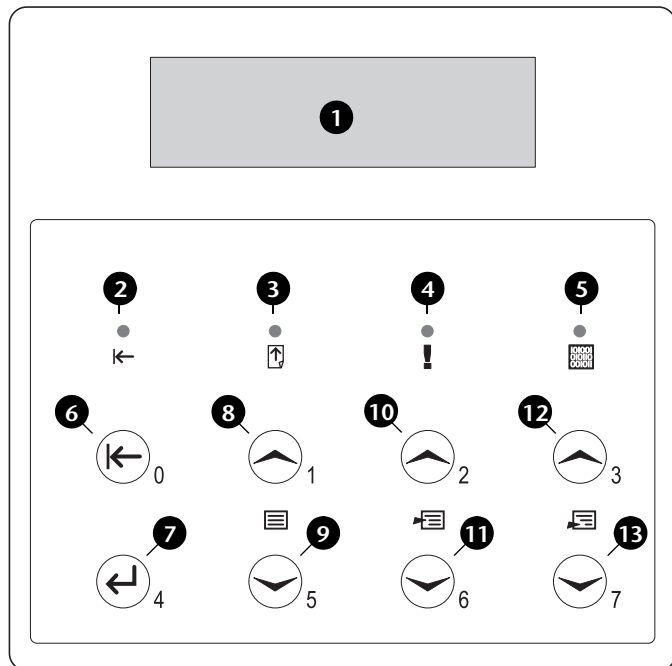

<sup>1</sup> Your Control Panel may look different.

## The Display

The Control Panel's display performs two functions.

- It informs you of printer status conditions, such as when toner is low, when a paper tray is empty, when a job is in process, and so on. For example, when you turn on the printer and it warms up, the display will show:



Ready

This message appears whenever the printer is online and ready to accept print jobs. The display will also show:



Processing...

when processing data, and:

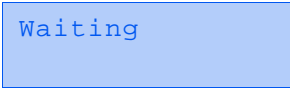

Waiting

when waiting for more data.

- It presents a hierarchy of menu options and settings to configure and control the printer.

For example, when you press **Menu Up** or **Menu Down**, the display will show:



Menus  
Item Menu

(such as [System Menu](#) or [Job Menu](#))

See the section “*Menu Options*” (page 3-40) for information on the Menu system hierarchy.

## The Indicator Lights

The Control Panel contains four indicator lights. Table 3.3 describes the function of each light.

**Table 3.3** Indicator lights and their functions

Light	Description
<b>Online (Green)</b>	Lights when the printer is online.  Flashes when the printer is transitioning from online to offline or to indicate that a print job is being processed.
<b>Form Feed (Green)</b>	Lights when the printer experiences a form feed timeout—that is, when a PCL job has formatted a partial page, the printer is waiting for more data in order to continue processing the job, and a 15 second timeout period has expired with no new data arriving in the input buffer. This timeout applies to all ports.  When lit, you can print a partial page by entering the Job menu, scrolling to the Form Feed item and pressing Enter. When not in the menu system, a partial page can be printed by pressing Enter. PostScript does not print partial pages and consequently the Form Feed light is not turned on.
<b>Fault (Amber)</b>	Lights whenever operator intervention is required in order to allow printing to continue.
<b>Data (Green)</b>	Flashes to indicate that a print job is being processed by either PostScript, PCL or PjL, or is being spooled to the optional hard disk (e.g., a proof or secure job).

## The Keys

The Control Panel keypad consists of eight keys, identified with international symbols and/or labeled in English. The keys are also numbered 0 - 7 for use when entering passwords.

Table 3.4 describes the function of each key.

**Table 3.4 Control Panel keys and their functions**

Key	Description
<b>Online</b>	<ul style="list-style-type: none"><li>• If the Printer is online and not in the menu system, takes the printer offline. All pages currently in the paper path are printed and then printing pauses until the printer is brought online again.</li><li>• If the printer is online and in the menu system, exits the menu system.</li><li>• If the printer is offline and not in the menu system, brings the printer online.</li><li>• If the printer is offline and in the menu system, exits the menu system and brings the printer online.</li></ul>
<b>Enter</b>	<ul style="list-style-type: none"><li>• If the current display is a value for an item, causes the value to be entered as the current default value for this item.</li><li>• If the current display is an action to be invoked (e. g. "PCL Font List", "Restart Printer"), causes the action to occur.</li><li>• If not in the menu system, and the "Press Enter" LED indicates that a partial page exists, causes an implied PCL reset and the partial page is ejected.</li><li>• If a paper mismatch condition exists, and a request to use an alternate paper is displayed, causes printing on the paper currently loaded in the selected tray (Print Anyway).</li></ul>
<b>Menu Up</b>	<ul style="list-style-type: none"><li>• If not in the menu system, enters the menu system and displays the first menu.</li><li>• If in the menu system, causes the Control Panel to scroll through the menus in order bottom to top.</li></ul>

Table 3.4 Page 1 of 2

Table 3.4 Control Panel keys and their functions (continued)

Key	Description
<b>Menu Down</b>	<ul style="list-style-type: none"> <li>• If not in the menu system, enters the menu system and displays the last menu.</li> <li>• If in the menu system, causes the Control Panel to scroll through the menus in order top to bottom.</li> </ul>
<b>Item Up</b>	<ul style="list-style-type: none"> <li>• If in the menu system, causes the Control Panel to scroll through the items in the current menu in order from bottom to top.</li> <li>• If not in the menu system, this key is ignored.</li> </ul>
<b>Item Down</b>	<ul style="list-style-type: none"> <li>• If in the menu system, causes the Control Panel to scroll through the items in the current menu in order from top to bottom.</li> <li>• If not in the menu system, this key is ignored.</li> </ul>
<b>Value Up</b>	<ul style="list-style-type: none"> <li>• If in the menu system, and an item is displayed, causes the Control Panel to scroll through the values for the current item in order bottom to top, and displays the default value for the current item. When setting a numeric value, increases the value by the step amount. It is subject to auto-repeat if held down by more than 1 second.</li> <li>• If not in the menu system, and a paper mismatch condition does not exist, this key is ignored.</li> <li>• If a paper mismatch condition exists, scrolls through the alternate paper that may be used instead of the requested paper.</li> </ul>
<b>Value Down</b>	<ul style="list-style-type: none"> <li>• If in the menu system, and an item is displayed, causes the Control Panel to scroll through the values for the current item in order top to bottom, and displays the default value for the current item. When setting a numeric value, decreases the value by the step amount. It is subject to auto-repeat if held down by more than 1 second.</li> <li>• If not in the menu system, and a paper mismatch condition does not exist, this key is ignored.</li> <li>• If a Paper Mismatch condition exists, pressing this key scrolls through the alternate paper that may be used instead of the requested paper.</li> </ul>

Table 3.4 Page 2 of 2

## Menu Options

Table 3.5 on the following pages lists the variables that can be controlled at the printer's Control Panel, organized by menu in the order in which they appear when scrolling through the display. Since these variables are generally used in configuring the printer's default settings—a System Administrator's task—specific details of the menu items and their values are contained in the *System Administrator Guide* on your product CD.

In addition, the *System Administrator Guide* lists all the operations associated with the Control Panel keys and lists the specific key processes which need to be executed to set any of these variables.



*Printer settings selected in your application or printer driver override the default settings in the Control Panel when you submit your print jobs for printing.*

---

Table 3.5 Control Panel Menu Options

Menu	Description and Items
<b>Job Menu</b>	Allows you to cancel the job currently processed by PCL or PostScript, or to force a form feed on a partially formatted job in PCL:
	<b>Cancel Job</b> Cancels the job currently printing.
	<b>Form Feed</b> Causes a partial PCL page to be ejected when the Form Feed LED is on.
	<b>Restart Printer</b> Re-boots the printer as if the power was cycled, but bypasses power on diagnostics.
<b>Password Menu</b>	Allows you to enter a four digit password to enable printing of secure or proof jobs previously sent to the printer and stored on the printer's hard drive (and appears only if the optional hard drive is installed).

Table 3.5 Page 1 of 14

Table 3.5 Control Panel Menu Options (continued)

Menu	Description and Items														
<b>Tray Menu</b>	<p>Allows you to access tray settings for PCL and PostScript jobs:</p> <table border="1" data-bbox="381 291 1289 911"> <tbody> <tr> <td data-bbox="386 291 625 374"><b>MBF Size</b></td> <td data-bbox="625 291 1289 374">Defines the paper size that is loaded in the multi bypass feeder.</td> </tr> <tr> <td data-bbox="386 374 625 458"><b>MBF Type</b></td> <td data-bbox="625 374 1289 458">Defines the paper type that is loaded in the multi bypass feeder.</td> </tr> <tr> <td data-bbox="386 458 625 541"><b>Tray N Type</b></td> <td data-bbox="625 458 1289 541">Defines the type of paper installed in Tray <i>N</i> (where <i>N</i> is the tray number—Tray 1, 2, or 3).</td> </tr> <tr> <td data-bbox="386 541 625 624"><b>Tray Sequence</b></td> <td data-bbox="625 541 1289 624">Defines the order in which trays are used when more than one tray meets the size and type requirements.</td> </tr> <tr> <td data-bbox="386 624 625 708"><b>Custom Size</b></td> <td data-bbox="625 624 1289 708">Defines the paper size that is to be used for formatting custom paper when a Tray Mode is set to <i>Custom</i>.</td> </tr> <tr> <td data-bbox="386 708 625 805"><b>Tray N Mode</b></td> <td data-bbox="625 708 1289 805">Determines whether or not the tray's auto size detection mechanism is overridden by custom size settings (where <i>N</i> is the tray number—Tray 1, 2, or 3).</td> </tr> <tr> <td data-bbox="386 805 625 911"><b>Config Fuser</b></td> <td data-bbox="625 805 1289 911">Enables the setting of fuser temperatures associated with each paper type. If set to <i>On</i>, paper types are available as a menu item.</td> </tr> </tbody> </table>	<b>MBF Size</b>	Defines the paper size that is loaded in the multi bypass feeder.	<b>MBF Type</b>	Defines the paper type that is loaded in the multi bypass feeder.	<b>Tray N Type</b>	Defines the type of paper installed in Tray <i>N</i> (where <i>N</i> is the tray number—Tray 1, 2, or 3).	<b>Tray Sequence</b>	Defines the order in which trays are used when more than one tray meets the size and type requirements.	<b>Custom Size</b>	Defines the paper size that is to be used for formatting custom paper when a Tray Mode is set to <i>Custom</i> .	<b>Tray N Mode</b>	Determines whether or not the tray's auto size detection mechanism is overridden by custom size settings (where <i>N</i> is the tray number—Tray 1, 2, or 3).	<b>Config Fuser</b>	Enables the setting of fuser temperatures associated with each paper type. If set to <i>On</i> , paper types are available as a menu item.
<b>MBF Size</b>	Defines the paper size that is loaded in the multi bypass feeder.														
<b>MBF Type</b>	Defines the paper type that is loaded in the multi bypass feeder.														
<b>Tray N Type</b>	Defines the type of paper installed in Tray <i>N</i> (where <i>N</i> is the tray number—Tray 1, 2, or 3).														
<b>Tray Sequence</b>	Defines the order in which trays are used when more than one tray meets the size and type requirements.														
<b>Custom Size</b>	Defines the paper size that is to be used for formatting custom paper when a Tray Mode is set to <i>Custom</i> .														
<b>Tray N Mode</b>	Determines whether or not the tray's auto size detection mechanism is overridden by custom size settings (where <i>N</i> is the tray number—Tray 1, 2, or 3).														
<b>Config Fuser</b>	Enables the setting of fuser temperatures associated with each paper type. If set to <i>On</i> , paper types are available as a menu item.														

Table 3.5 Page 2 of 14



Table 3.5 Control Panel Menu Options (continued)

Menu	Description and Items
PCL Menu	Allows you to establish the default configuration for the printer when printing PCL emulation jobs:
	<b>Font Number</b> Sets the default font in PCL.
	<b>Pitch</b> Sets the pitch of the default font in PCL when the default font already selected is a scalable fixed pitch font.
	<b>Point Size</b> Sets the point size of the default font in PCL when the default font already selected is a scalable proportional spaced font.
	<b>Symbol Set</b> Sets the default font symbol set used in PCL.
	<b>Orientation</b> Sets the default orientation used in PCL (not used by PostScript).
	<b>Form Length</b> Sets the default number of lines per page used in PCL.
	<b>Line Terminat</b> Enables the setting of an additional carriage return after every line feed appearing in PCL text.

Table 3.5 Page 3 of 14

Table 3.5 Control Panel Menu Options (continued)

Menu	Description and Items
<b>System Menu</b>	Allows you to set general printer features:
	<b>Language</b> Sets the language used for Control Panel display messages and generated reports.
	<b>Paper Size</b> Sets the default paper size used in PCL and PostScript.
	<b>Paper Type</b> Sets the default paper type used in PostScript and PCL.
	<b>Page Policy</b> Allows the printer to automatically select an alternate paper size and/or type if the requested size and/or type is not loaded.
	<b>Policy Timeout</b> Directs the printer as to how long to wait before taking the action defined by the setting of the Page Policy item.
	<b>Print Quantity</b> Sets multiple copies of each page (not collated sets).
	<b>Duplex</b> Enables or disables duplex printing for PostScript and PCL jobs (and appears only when the optional duplex unit is installed).
	<b>Draft Mode</b> Enables or disables a reduced toner mode for draft printing.
	<b>Edge-to-Edge</b> Enables or disables edge-to-edge printing in PCL.

Table 3.5 Page 4 of 14

Table 3.5 Control Panel Menu Options (continued)

Menu	Description and Items	
<b>System Menu (continued)</b>	<b>XIE</b>	Sets the default Xerox Image Enhancement (XIE) mode used in PCL and PostScript.
	<b>Resolution</b>	Sets the default resolution for PCL and PostScript jobs.
	<b>Output Timeout</b>	Determines whether the printer will select an alternate bin when the selected output bin becomes full.
	<b>Output Offset</b>	Enables or disables offsetting of output from alternating jobs.
	<b>Output Dest</b>	Sets the default paper output destination for PCL and PostScript jobs.
	<b>Print PS Errors</b>	Controls the use of the built in PostScript error handler or debugger.
	<b>Power Saver</b>	Defines a period of inactivity after which time the printer will enter a low power state.
	<b>Defaults</b>	Sets the type of factory defaults to use when a "Factory Default" is performed.

Table 3.5 Page 5 of 14

Table 3.5 Control Panel Menu Options (continued)

Menu	Description and Items
<b>Parallel Menu</b>	Allows you to set options for the parallel port connection:
	<b>Port Enable</b> Enables or disables the parallel port.
	<b>Port Timeout</b> Sets the time for determining when to end an incomplete print job and poll the next port in the polling sequence.
	<b>Parallel PDL</b> Sets the default Page Description Language emulation for the parallel port.
	<b>Binary PS</b> Enables or disables the binary mode of PostScript for this port.
	<b>Bidirectional</b> Enables or disables bidirectional communications through the parallel port.
<b>Serial Menu</b>	Allows you to set options for the serial port connection (and appears only if the optional serial port is installed):
	<b>Port Enable</b> Enables or disables the serial port.
	<b>Port Timeout</b> Sets the time for determining when to end an incomplete print job and poll the next port in the polling sequence.
	<b>Serial PDL</b> Sets the default Page Description Language emulation for the serial port.
	<b>Flow Control</b> Sets the handshaking parameters for the serial port.
	<b>Baud Rate</b> Sets the baud rate for the serial port.
	<b>Binary PS</b> Enables or disables the binary mode of PostScript for this port.

Table 3.5 Page 6 of 14

Table 3.5 Control Panel Menu Options (continued)

Menu	Description and Items
USB Menu	Allows you to set options for the USB port connection:
	<b>Port Enable</b> Enables or disables the USB port.
	<b>Port Timeout</b> Sets the time for determining when to end an incomplete print job and poll the next port in the polling sequence.
	<b>USB PDL</b> Sets the default emulation Page Description Language for the USB port.
	<b>Binary PS</b> Enables or disables the binary mode of PostScript for this port.

Table 3.5 Page 7 of 14

Table 3.5 Control Panel Menu Options (continued)

Menu	Description and Items	
<b>Ethernet Menu</b>	Allows you to set options for the Ethernet port connection:	
	<b>LPR Enable</b>	Enables or disables the Ethernet LPR protocol.
	<b>LPR Banner</b>	Enables or disables the LPR banner sheet.
	<b>LPR PDL</b>	Sets the default Page Description Language emulation for the Ethernet LPR protocol.
	<b>LPR Binary PS</b>	Enables or disables the LPR binary mode of PostScript.
	<b>DLC/LLC Enable</b>	Enables or disables the Ethernet DLC/LLC protocol.
	<b>DLC/LLC PDL</b>	Sets the default Page Description Language emulation for the Ethernet DLC protocol.
	<b>DLC/LLC Bin PS</b>	Enables or disables the DLC/LLC binary mode of PostScript.
	<b>NetBEUI Enable</b>	Enables or disables the Ethernet NetBEUI interface.
	<b>NetBEUI PDL</b>	Sets the default Page Description Language emulation for the Ethernet NetBEUI interface.
	<b>NetBEUI Bin PS</b>	Enables or disables the NetBEUI binary mode of PostScript.
	<b>AppSocket Enabl</b>	Enables or disables the Ethernet AppSocket interface.
	<b>AppSocket PDL</b>	Sets the default Page Description Language emulation for the Ethernet AppSocket interface.
<b>AppSocket Bin PS</b>	Enables or disables the AppSocket binary mode of PostScript.	

Table 3.5 Page 8 of 14

Table 3.5 Control Panel Menu Options (continued)

Menu	Description and Items	
Ethernet Menu (continued)	ETalk Enable	Enables or disables the Ethernet EtherTalk protocol.
	HTTP Enable	Enables or disables the Ethernet HTTP Server protocol.
	IP Address Res	Sets the method used to resolve (Res) the IP address, including subnet mask and default gateway.
	IP Address	Sets the four byte IP address. This item appears only if the IP Address Res is set to static.
	Sub Net Mask	Sets the four byte Sub Net Mask address. This item appears only if the IP Address Res is set to static.
	Default Gateway	Sets the four byte Default Gateway address. This item appears only if the IP Address Res is set to static.
	Port Timeout	Sets the time for determining when to end an incomplete print job and poll the next port in the polling sequence.
	Speed	Sets the speed of the 10/100 Ethernet interface and whether half or full duplex Ethernet.

Table 3.5 Page 9 of 14

Table 3.5 Control Panel Menu Options (continued)

Menu	Description and Items	
<b>Token Ring Menu</b>	Allows you to set options for the Token Ring port connection (and appears only if the optional Token Ring interface is installed):	
	<b>LPR Enable</b>	Enables or disables the Token Ring LPR protocol.
	<b>LPR Banner</b>	Enables or disables the LPR banner sheet.
	<b>LPR PDL</b>	Sets the default Page Description Language emulation for the Token Ring LPR protocol.
	<b>LPR Binary PS</b>	Enables or disables the LPR binary mode of PostScript.
	<b>DLC/LLC Enable</b>	Enables or disables the Token Ring DLC/LLC protocol.
	<b>DLC/LLC PDL</b>	Sets the default emulation Page Description Language for the Token Ring DLC protocol.
	<b>DLC/LLC Bin PS</b>	Enables or disables the DLC/LLC binary mode of PostScript.
	<b>NetBEUI Enabl</b>	Enables or disables the Token Ring NetBEUI interface.
	<b>NetBEUI PDL</b>	Sets the default Page Description Language emulation for the Token Ring NetBEUI interface.
	<b>NetBEUI Bin PS</b>	Enables or disables the NetBEUI binary mode of PostScript.
	<b>AppSocket Enabl</b>	Enables or disables the Token Ring AppSocket interface.
	<b>AppSocket PDL</b>	Sets the default Page Description Language emulation for the Token Ring AppSocket interface.
	<b>AppSocket Bin PS</b>	Enables or disables the AppSocket binary mode of PostScript.

Table 3.5 Page 10 of 14



Table 3.5 Control Panel Menu Options (continued)

Menu	Description and Items	
Token Ring Menu (continued)	TTalk Enable	Enables or disables the Token Ring TokenTalk protocol.
	HTTP Enable	Enables or disables the Token Ring HTTP Server protocol.
	IP Address Res	Sets the method used to resolve (Res) the IP address, including subnet mask and default gateway.
	IP Address	Sets the four byte IP address. This item appears only if the IP Address Res is set to static.
	Sub Net Mask	Sets the four byte Sub Net Mask address. This item appears only if the IP Address Res is set to static.
	Default Gateway	Sets the four byte Default Gateway address. This item appears only if the IP Address Res is set to static.
	Port Timeout	Sets the time for determining when to end an incomplete print job and poll the next port in the polling sequence.
	Source Routing	Sets the source routing option.
	Speed	Sets the default ring speed of the Token Ring interface.
	LAA	Sets the six byte Locally Administered Address.

Table 3.5 Page 11 of 14

**Table 3.5** Control Panel Menu Options (*continued*)

Menu	Description and Items
<b>Novell Menu</b>	Allows you to modify Novell parameters:
	<b>Novell Enable</b> Enables or disables the Novell protocol.
	<b>Novell PDL</b> Sets the default emulation for the Novell protocol.
	<b>Novell Binary PS</b> Enables or disables the Novell binary mode of PostScript.
	<b>Novell Mode</b> Sets the PServer mode for the Novell protocol.
	<b>Frame Type</b> Sets the frame type used for the Novell protocol.
	<b>Polling Interval</b> Sets the rate (in seconds) at which the PServer issues polling requests for assigned queues.
	<b>PServer Name</b> Sets the name of the PServer in this printer.
	<b>Primary Server</b> Sets the name of the Primary file server.
	<b>NDS Tree</b> Sets the NDS Tree character string.
	<b>NDS Context</b> Set the NDS context string.

Table 3.5 Page 12 of 14

Table 3.5 Control Panel Menu Options (continued)

Menu	Description and Items
Print Menu	<p>Allows you to generate printer reports:</p> <p><b>Config Sheet</b> Prints a Configuration Sheet showing the printer's current information and menu settings.</p> <p><b>PCL Demo</b> Prints a sample page demonstrating the printer's capabilities.</p> <p><b>PCL Font List</b> Prints a list of PCL fonts currently loaded.</p> <p><b>PS Font List</b> Prints a complete list of all PostScript language typefaces.</p> <p><b>Menu Map</b> Prints a page showing the structure of the Control Panel Menu Tree.</p> <p><b>Test Print</b> Prints a "test pattern" for analysis of print quality over the entire page (intended for use by the service technician).</p> <p><b>Disk Directory</b> Prints a copy of the disk directory (and appears only if the optional hard drive is installed).</p> <p><b>Fault History</b> Prints the Fault History Log.</p> <p><b>Display Faults</b> Displays the last 100 faults on the Control Panel.</p> <p><b>Hex Mode</b> Enables or disables hex dump mode, which prints the data stream as hex codes instead of interpreting it as print data.</p> <p><b>Restart Printer</b> Reboots the printer as if the power was cycled.</p>

Table 3.5 Page 13 of 14

**Table 3.5** Control Panel Menu Options (*continued*)

Menu	Description and Items
<b>Reset Menu</b>	Allows you to access printer reset functions (and appears only when the printer is powered on while holding down the Online and Enter keys).
	<b>Factory Defaults</b> Resets menus to factory defaults.
	<b>Network Defaults</b> Resets parameters in the Ethernet, Token Ring, and Novell Menus to factory defaults.
	<b>Demo Mode</b> Places the printer in demo mode.
	<b>Delete All Jobs</b> Deletes all secure jobs from the hard disk (and appears only if the optional hard drive is installed).
	<b>Disk Initialize</b> Initializes the hard disk (and appears only if the optional hard drive is installed).
	<b>Disk Format</b> Formats the hard disk (and appears only if the optional hard drive is installed).
	<b>Flash Format</b> Initializes flash memory.
Table 3.5 Page 14 of 14	

## Printing a Password Job

To print a password print job sent to the printer and stored in the optional hard drive (such as a secure job or proof job), follow these steps:

- 1 At the Control Panel, press **Menu Up** or **Menu Down** until you see:

```
Menus
Password Menu
```

- 2 Press **Item Up** or **Item Down** and you will see:

```
Enter password
_XXX
```

- 3 Enter the job's numeric password and you will see:

```
All Jobs      =
Print
```

- 4 Press **Enter** to print all jobs.

OR:

Press **Item Up** or **Item Down** to scroll through the jobs, then press **Enter** when the job you wish to print is shown. Repeat this step as necessary to release more than one job.

- 5 When done, press **Online**.

## Deleting a Password Job

To delete a password print job sent to the printer and stored in the optional hard drive, follow these steps:

- 1 At the Control Panel, press **Menu Up** or **Menu Down** until you see:

```
Menus
Password Menu
```

- 2 Press **Item Up** or **Item Down** and you will see:

```
Enter password
_XXX
```

- 3 Enter your job's numeric password and you will see:

```
All Jobs      =
Print
```

- 4 Press **Value Up** or **Value Down** and you will see:

```
All Jobs      =
Delete
```

- 5 Press **Enter** to delete all jobs.

OR:

Press **Item Up** or **Item Down** to scroll through the jobs, until the job you wish to delete is shown. If **Print** shows on the bottom line, press **Value Up** or **Value Down** to show **Delete** instead. Then press **Enter**. Repeat this step as necessary to delete more than one job.

- 6 When done, press On Line.

## Generating a Printer Report

Your printer provides the following reports that can be printed:

- Configuration Sheet
- PCL Demo
- PCL Font List
- PostScript Font List
- Menu Map
- Test Print
- Disk Directory (if the optional hard drive is installed)
- Fault History

To print a report, follow these steps:

- 1 At the Control Panel, press **Menu Up** or **Menu Down** until you see:



Menus  
Print Menu

- 2 Press **Item Up** or **Item Down** until you see the page you want to print (such as Config Sheet).
- 3 Press **Enter** to print the page.

## Offsetting Output

The Offset Catch Tray, shown in Figure 3.2, is an optional output device available for your printer.

**Figure 3.2** Offset Catch Tray (front view)

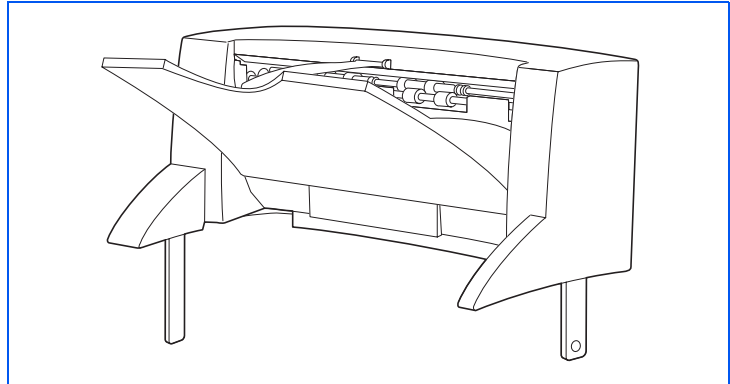

It can be used in either of two ways, depending on how it is configured in the Control Panel's menu system:

- As an additional 500-sheet capacity output bin to supplement the 500-sheet standard output bin.
- To alternately print jobs and copies of the same print job.

To use the Offset Catch Tray, submit your print jobs as usual (refer to Table 2.1 on page 2-4 for supported media). Output is directed to it by means of the Offset Bin item in the printer driver or the Output Dest item in the Control Panel's System Menu. The System Menu's Output Offset item controls whether or not the device will offset successive print jobs or copies.

Refer to the *System Administrator Guide* on the product CD for detailed instructions on configuring the Offset Catch Tray for use.



## Duplex Printing

---

With the optional duplex unit installed, you can print two-sided (duplex) jobs.

Use only the size paper listed in Table 2.1 on page 2-4 for two-sided jobs. Do not use envelopes, postcards, transparencies, or label paper for duplex jobs.

To print duplex, select it in your printer driver when you set printer properties (for all jobs) or when you print a document (for the specific job).

To ensure that duplex jobs print in the proper orientation, set the driver's **Orientation** and **Duplex** options to the appropriate settings, as shown in Figure 3.3 on page 3-60.

Figure 3.3 Duplex Orientation and Binding Settings

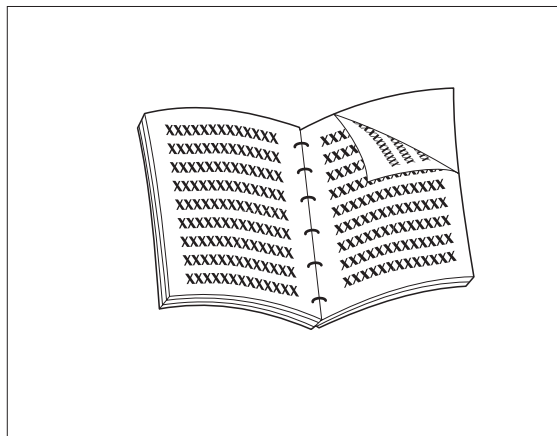

Orientation: *Portrait*  
Duplex: *Long Edge Bind*

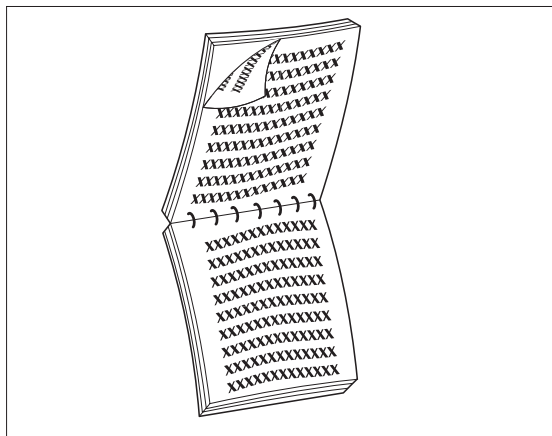

Orientation: *Portrait*  
Duplex: *Short Edge Bind*

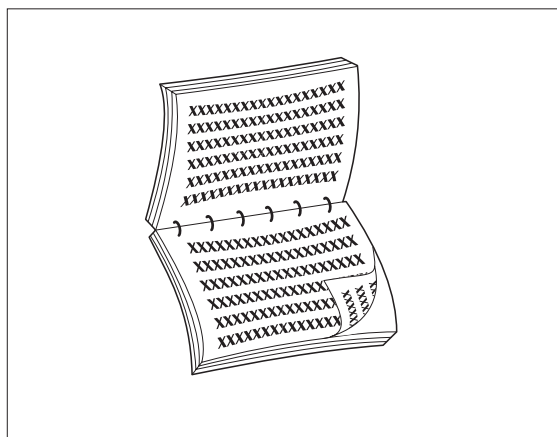

Orientation: *Landscape*  
Duplex: *Long Edge Bind*

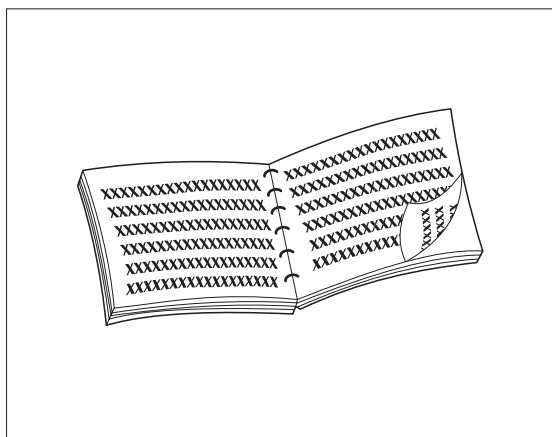

Orientation: *Landscape*  
Duplex: *Short Edge Bind*

## Configuring Custom Paper Sizes

---

Custom (nonstandard) paper sizes may be loaded in the multi bypass feeder or any of the media trays. To use custom paper sizes, there are two basic issues to be addressed:

- You must disable the printer's automatic paper size detection and paper size jam detection.
- Although you may physically load a custom paper size in an input source, because PCL and PostScript format pages to standard sizes, you must properly set margins (or use other application formatting methods) to position the image correctly on the custom paper.

To print on custom size paper, disable the printer's automatic paper size detection and paper size jam detection by setting the Tray Menu's **Tray 1 Mode**, **Tray 2 Mode**, **Tray 3 Mode** or **MBF Size** item (depending on which input source you are using) to *Custom*, then set the **Custom Size** item to the standard size to be used by PCL or PostScript to format the page.



*To prevent the printer from incorrectly loading standard paper from another input source when the Custom Size setting is the same value as the auto-detected size in that other input source, you must exclude the tray with the custom size from the Tray Sequence setting and specifically select that tray as the input source.*

---

Refer to Table 3.6 on page 3-62 for usage examples.

**Table 3.6 Custom Paper Size Examples.**

Custom Paper Size	Desired Input Source	Required Steps
8 x 10 in.	Tray 1	<ol style="list-style-type: none"> <li>1. In the application, format the page for Letter size paper, setting the margins to correctly position the image on 8 x 10" paper if overlaid by Letter size paper.</li> <li>2. Load the 8 x 10" paper in Tray 1.</li> <li>3. Set the Tray Menu <b>Tray 1 Mode</b> to <i>Custom</i>.</li> <li>4. Set the Custom Size to <i>Letter (8.5x11")</i>.</li> <li>5. Set the "Tray Sequence" to a value that does not include Tray 1 (or set to <i>Off</i>).</li> <li>6. Request <b>Tray 1</b> as the paper source and send the print job.</li> </ol>
6 x 7 in	Multi Bypass Feeder	<ol style="list-style-type: none"> <li>1. In the application, format the page for Letter size paper, setting the margins to correctly position the image on 6 x 7 in paper if overlaid by Letter size paper.</li> <li>2. Load the 6 x 7" paper in Tray 1.</li> <li>3. Set the Tray Menu <b>MBF Size</b> to <i>Custom</i>.</li> <li>4. Set the <b>Custom Size</b> to <i>Letter (8.5 x11")</i>.</li> <li>5. Set the <b>Tray Sequence</b> item to value that does not include MBF (or set to <i>Off</i>).</li> <li>6. Request <b>MBF</b> as the paper source and send the print job.</li> </ol>
8.5 x 11 in. Short Edge Feed (SEF)	Tray 1	<ol style="list-style-type: none"> <li>1. In the application, format the page for Folio size paper (because Folio is a short-edge feed size on this printer), setting the margins to correctly position the image on the 11 inches to be used by this paper.</li> <li>2. Load the 8.5 x 11" paper into Tray 1 in the SEF direction. This requires a Ledger/A3 size tray. The paper length guide will be set to 11 inches, rather than the width guide. (Set the width guide to 8.5".)</li> <li>3. Set the Tray Menu <b>Tray 1 Mode</b> to <i>Custom</i>.</li> <li>4. Set the <b>Custom Size</b> to <i>Folio (8.5 x13")</i>.</li> <li>5. Set the <b>Tray Sequence</b> item to value that does not include Tray 1 (or set to <i>Off</i>).</li> <li>6. Request <b>Tray 1</b> as the paper source and send the print job.</li> </ol>

**Table 3.6**

# Special Media Printing

---

When the **Config Fuser** item is set to *On*, paper types are available as a menu item in the **Tray Menu**. This enables the user to set fuser temperatures associated with each paper type. The **Config Fuser** item is located in the **Tray Menu**.

Each paper type has three temperature settings:

- Normal
- High (fuser temperature higher than normal)
- Low (fuser temperature lower than normal)

To print special media:

1. Load the special media into a paper tray.
2. Set the **Tray Type** to the special media loaded in the tray.
3. From your driver properties, choose **Select Paper**. Set **Type** to the special media loaded.
4. Close properties and print.

Table 3.7 on page 3-64 lists the default temperature settings for various media.

**Table 3.7 Default temperature settings for various media**

Media type	Available Values
Plain	Normal* High Low
Preprinted	Normal* High Low
Letterhead	Normal* High Low
Prepunched	Normal* High Low
Labels	Normal High* Low
Bond	Normal* High Low
Recycled	Normal* High Low
Color	Normal* High Low
Cardstock	Normal High* Low
User Type #	Normal* High Low

\* Default setting

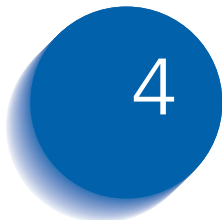

## ***Maintaining the Printer***

<i>Regular Printer Maintenance .....</i>	<i>4-2</i>
<i>Cleaning the Printer .....</i>	<i>4-2</i>
<i>Replacing the Laser Print Cartridge .....</i>	<i>4-3</i>
<i>Replacing Maintenance Kit Items .....</i>	<i>4-6</i>

## Regular Printer Maintenance

---

Your printer is designed to need very little ongoing maintenance other than the replacement of maintenance items as they reach their end of use. It is recommended that maintenance items be replaced when the end of use warnings appear on the Control Panel to avoid untimely image quality problems. However, it is always good practice to periodically clean any loose toner or foreign matter in your printer. See the *System Administrator Guide* on the product CD for procedures and cautions.



*For optimum performance, keep the printer out of direct sunlight. Faded images, light areas or dark bands may result.*

---

### Cleaning the Printer

For optimum performance, do not place the printer near vents or dust-producing equipment. Particles in the air may enter the printer and cause failures in internal mechanisms.

For best results, clean the outside of the printer with a damp cloth. Power the printer off before cleaning. Do not use detergents.

For instructions on cleaning the inside of the printer, refer to the *System Administrator Guide* on the product CD.



# Replacing the Laser Print Cartridge

When the laser print cartridge runs low on toner, the printer's Control Panel display will prompt you to replace the cartridge. This is a simple procedure, described on the following pages.



- *Do not expose the cartridge to direct sunlight or artificial light for more than 15 minutes. Overexposure will permanently damage the photosensitive imaging drum.*
- *Do not open the drum shutter (see Figure 4.1 below) or touch the green imaging drum surface.*
- *Be sure to shake the cartridge as directed to distribute the toner inside the cartridge. Print quality may be degraded or damage may occur if the toner is not evenly distributed.*

Figure 4.1 Drum Shutter Location

1 Drum shutter

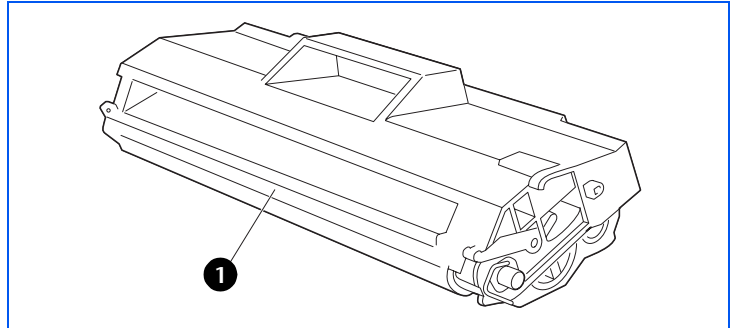

To replace the laser print cartridge, follow these steps:

- 1 Open the top cover.

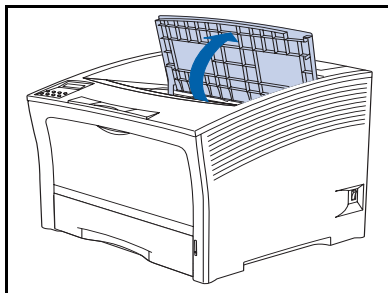

- 2 Lift out the used cartridge.



*Wrap the used cartridge in its original packing and return it as per directions in the packaging.*

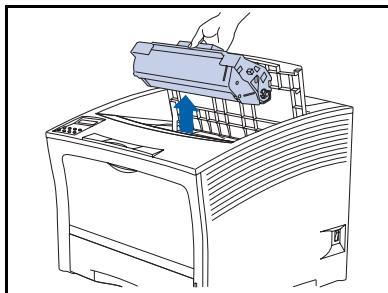

- 3 Remove a new cartridge from its packing and shake the cartridge seven to eight times, as shown, to free the toner.

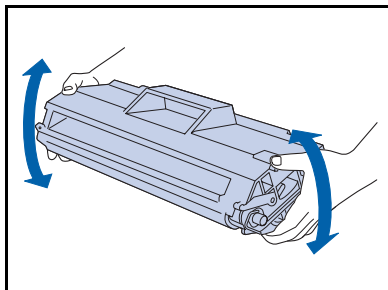

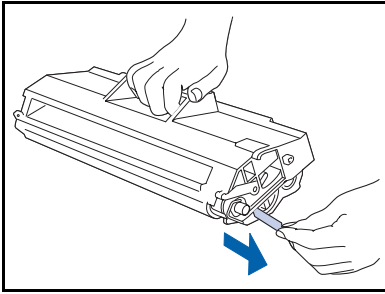

- 4 Place the cartridge on a flat surface, press it down with one hand and with the other grasp the end tab of the sealing tape and pull the tape straight out horizontally.



**If pulled at an angle, the tape may break. After pulling out the tape, do not shake the cartridge or subject it to shocks.**

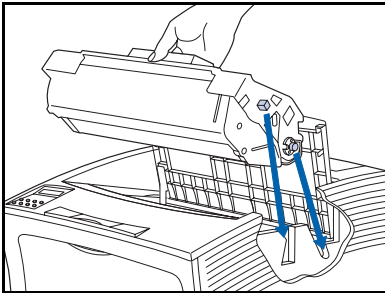

- 5 Holding the cartridge as shown, lower it into the printer, inserting the cartridge's two projecting parts into the printer's guide channels.



**Be sure to push the cartridge all the way into the printer.**

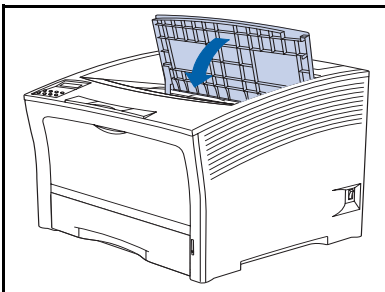

- 6 Close the top cover until it locks in place.

## Replacing Maintenance Kit Items

---

The Maintenance Kit includes the Bias Transfer Roller and the Fuser, which are internal printer components that require replacement from time to time. As these are more complex tasks that are not routinely performed, the procedures are provided in the *System Administrator Guide* on your product CD.



# 5

## Troubleshooting

<i>Before You Begin Troubleshooting</i> .....	5-2
<i>Error Messages</i> .....	5-4
<i>Paper Jams</i> .....	5-5
<i>What Causes a Paper Jam?</i> .....	5-5
<i>Paper Jam Messages</i> .....	5-5
<i>Paper Jam While Feeding through Duplex Module</i> .....	5-7
<i>Paper Jam While Exiting to Standard Output Bin</i> .....	5-8
<i>Paper Jam While Feeding to Offset Catch Tray</i> .....	5-10
<i>Paper Jam While Feeding from Tray 1</i> .....	5-12
<i>Paper Jam While Feeding from 2,000 Sheet Feeder</i> .....	5-15
<i>Paper Jam While Feeding from 500 Sheet Feeder</i> .....	5-18
<i>Paper Jam While Printing</i> .....	5-23
<i>Paper Jam Because of Mismatch between Expected and Actual Size Fed</i> .....	5-26
<i>Solving Printing Problems</i> .....	5-27
<i>Solving Print Quality Problems</i> .....	5-31
<i>Additional Sources of Troubleshooting Assistance</i> .....	5-39

## Before You Begin Troubleshooting

---

If it becomes necessary for you to take corrective actions, note the following safety tips and then begin your troubleshooting by checking for possible hardware, software, and printer maintenance issues.



*Do not use tools or sharp objects to clear paper jams since this may damage the printer. Do not touch the surface of the Print Drum or the Transfer Drum. Touching these surfaces may damage them.*



*Avoid contact with the printer's fuser area, which may be hot.*

---

Also, be sure to observe the safety guidelines and recommendations provided in the Safety Notes.

If your printer is not operating properly, make sure that the following hardware and software issues have been considered.

## Hardware

- Is the printer plugged in?
- Is the printer switched on?

## Software

- Is the correct printer driver installed and selected for your printer configuration?

## Printer Maintenance

An improperly seated tray or an open cover will prevent printing. You can avoid these problems by regularly taking the following precautions.

- Insert media trays properly and securely.
- Keep covers securely closed.

## Consumables

An empty print cartridge or expended maintenance item will degrade printing.

- Keep consumables and maintenance items in supply.
- Add or replace when prompted by printer.



*Specific instructions for replacing each consumable and maintenance item are included with the individual replacement packages.*

---

## Error Messages

---

Your printer displays messages on the Control Panel when operator intervention is required. There are two types of message that require action:

- Printer fault messages are those that relate to printer shutdown, such as a paper jam. Action must be taken to resolve the fault.
- Attention messages do not result in printer shutdown, but warn of action that should be taken to avert a shutdown.

The two-line display of the Control Panel provides information about the condition of the printer and the suggested or required course of action. Messages about paper jams are described in the next section. For a complete listing of all Control Panel messages, along with detailed descriptions and instructions, refer to the *System Administrator Guide* on the DocuPrint CD.



# Paper Jams

---

Your printer has been designed to provide reliable, trouble-free operation. However, you may experience an occasional paper jam.

When the printer detects a misfeed or a paper jam, it stops printing and displays a Control Panel message.

After you clear the paper jam, the printer will resume operation to complete the print job. The pages in the print engine will be reprinted when the jam is cleared and printing resumes.

## What Causes a Paper Jam?

Paper jams occur most often when:

- The paper stock does not meet specification. See “*Selecting Print Media*” (page 2-2).
- The paper stock is in poor condition.
- The printer needs cleaning.
- Printer parts are worn and need to be replaced.
- A paper tray is not securely closed.

## Paper Jam Messages

Table 5.1 lists the types of paper jams that may occur. If you see a Control Panel message that indicates a paper jam, find the message in the left-hand column and perform the accompanying steps to clear the paper jam.





***Be careful not to touch any of the components inside the printer when removing jammed paper. They may be very hot.***

Table 5.1 Paper jam messages

Message	Description/Corrective Action
Duplex Jam- Open Rear Cover	A paper jam has occurred at the duplex unit. ACTION: Refer to <i>"Paper Jam While Feeding through Duplex Module"</i> (page 5-7).
Exit Jam- Open Rear & Top Cover	A paper jam has occurred at the exit path to the output bin. ACTION: Refer to <i>"Paper Jam While Exiting to Standard Output Bin"</i> (page 5-8).
Offset Jam- Open Rear Cover	A paper jam has occurred at the offset catch tray. ACTION: Refer to <i>"Paper Jam While Feeding to Offset Catch Tray"</i> (page 5-10).
Tray 1 Jam- Open Tray 1	A paper jam has occurred while feeding from Tray 1. ACTION: Refer to <i>"Paper Jam While Feeding from Tray 1"</i> (page 5-12).
Tray 2 Jam- Open Tray 2	A paper jam has occurred while feeding from Tray 2. ACTION: If Tray 2 is a 2,000 sheet feeder, refer to <i>"Paper Jam While Feeding from 2,000 Sheet Feeder"</i> (page 5-15). If Tray 2 is a 500 sheet feeder, refer to <i>"Paper Jam While Feeding from 500 Sheet Feeder"</i> (page 5-18).
Tray 3 Jam- Open Tray 3	A paper jam has occurred while feeding from Tray 3. ACTION: If Tray 3 is a 2,000 sheet feeder, refer to <i>"Paper Jam While Feeding from 2,000 Sheet Feeder"</i> (page 5-15). If Tray 3 is a 500 sheet feeder, refer to <i>"Paper Jam While Feeding from 500 Sheet Feeder"</i> (page 5-18).
Paper Jam- Open Top Cover	A paper jam has occurred inside the top cover or the multi bypass feeder. ACTION: Refer to <i>"Paper Jam While Printing"</i> (page 5-23).
Paper Size Jam- Open Rear Cover	The size of the paper fed was not the size expected by the printer, causing a jam inside the rear cover. ACTION: Refer to <i>"Paper Jam Because of Mismatch between Expected and Actual Size Fed"</i> (page 5-26).



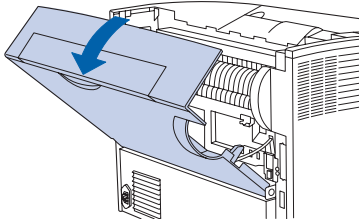

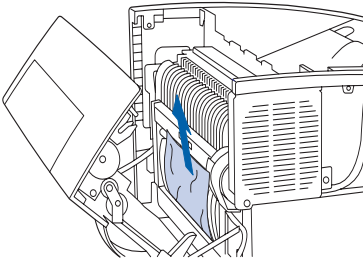
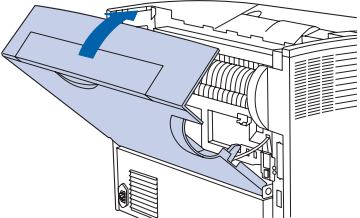

## Paper Jam While Feeding through Duplex Module

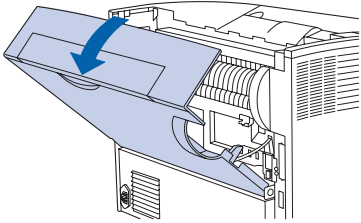

Follow these steps to clear the jam.

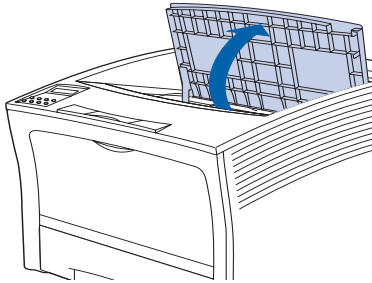
Control Panel Message	Corrective Action	
<p>Duplex Jam- Open Rear Cover</p>		<p><b>1</b> Open the rear cover.</p> <p> <b>Be careful not to touch the fuser. It becomes very hot from printing.</b></p>
<p>Clear Paper Path</p>		<p><b>2</b> Check and carefully pull out any jammed paper.</p>
<p>Close Covers</p>		<p><b>3</b> Close the rear cover.</p> <p><b>4</b> Check the Control Panel display. If the jam has been cleared and all covers are closed, the Control Panel will display <b>Processing</b> or <b>Ready</b>. If a paper jam message remains, there is still paper jammed in the printer. Refer to Table 5.1 on page 5-6 for instructions.</p>

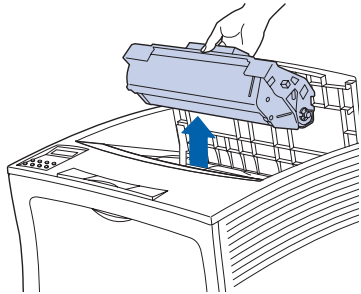
## Paper Jam While Exiting to Standard Output Bin

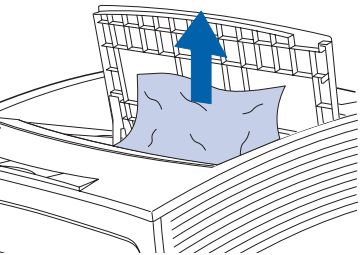

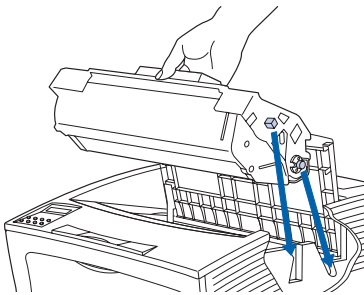
Follow these steps to clear the jam.

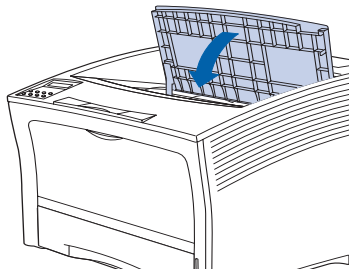
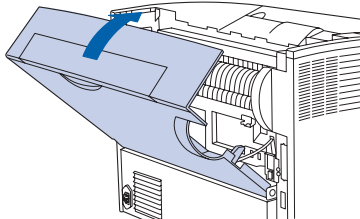
Control Panel Message	Corrective Action	
<p>Exit Jam- Open Rear &amp; Top Cover</p>		<p><b>1</b> Open the rear cover.</p> <p> <b>Be careful not to touch the fuser. It becomes very hot from printing.</b></p>
		<p><b>2</b> Open the top cover all the way to the back until it stops.</p> <p> <b>Be sure to remove any paper that may be in the output bin.</b></p>
<p>Remove PrintCart Clear Paper Path</p>		<p><b>3</b> Pull out the laser print cartridge and set it down on a flat surface.</p> <p> <b>To prevent stains, place the cartridge on a surface covered with old newspaper or some other disposable material.</b></p>
		<p><b>4</b> Check the area where the laser print cartridge was located and remove any jammed paper.</p> <p>Check and carefully remove any jammed paper under the rear cover.</p>

Control Panel Message	Corrective Action
	 <p><b>5</b> Reinstall the cartridge, inserting its two projecting parts into the printer's guide channels.</p> <p> <b>Be sure to push the cartridge all the way into the printer.</b></p>
	 <p><b>6</b> Close the top cover.</p>
	 <p><b>7</b> Close the rear cover.</p> <p><b>8</b> Check the Control Panel display. If the jam has been cleared and all covers are closed, the Control Panel will display <b>Processing</b> or <b>Ready</b>. If a paper jam message remains, there is still paper jammed in the printer. Refer to Table 5.1 on page 5-6 for instructions.</p>

## Paper Jam While Feeding to Offset Catch Tray

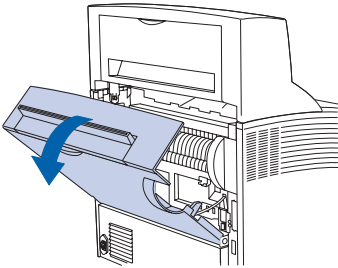

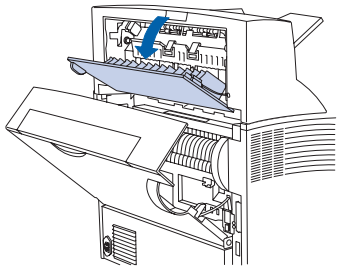
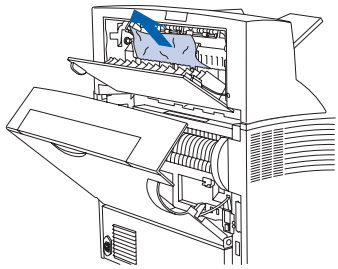

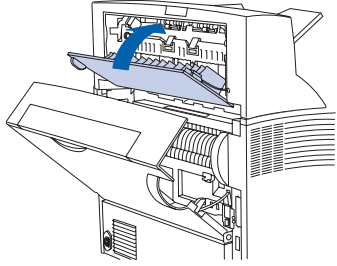
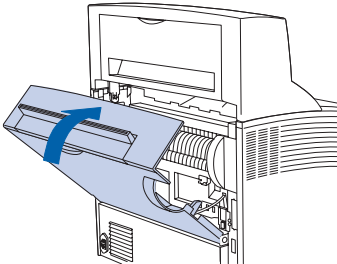
Follow these steps to clear the jam.

Control Panel Message	Corrective Action
<p>Offset Jam- Open Rear Cover</p>	 <p><b>1</b> Open the rear cover.</p> <p> <b>Be careful not to touch the fuser. It becomes very hot from printing.</b></p>
<p>Open Offset Door Clear Paper Path</p>	 <p><b>2</b> Open the Offset Catch Tray's rear cover.</p>
	 <p><b>3</b> Remove any jammed paper inside either open cover.</p>



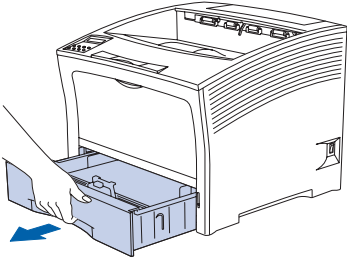

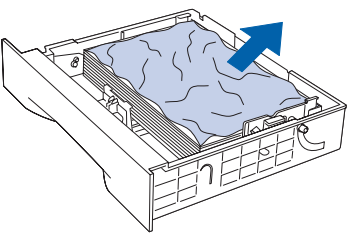
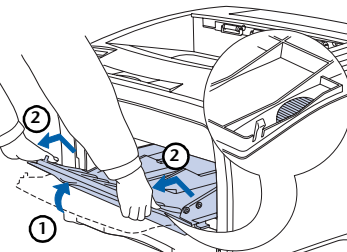
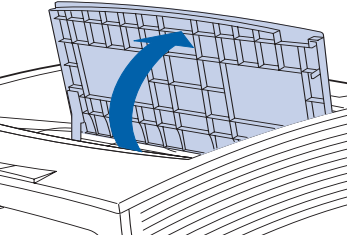
Control Panel Message	Corrective Action
	 <p data-bbox="872 222 1288 279"><b>4</b> Close the Offset Catch Tray's rear cover.</p>
	 <p data-bbox="872 539 1288 569"><b>5</b> Close the printer's rear cover.</p> <p data-bbox="872 604 1288 887"><b>6</b> Check the Control Panel display. If the jam has been cleared and all covers are closed, the Control Panel will display <b>Processing</b> or <b>Ready</b>. If a paper jam message remains, there is still paper jammed in the printer. Refer to Table 5.1 on page 5-6 for instructions.</p>

## Paper Jam While Feeding from Tray 1

Follow these steps to clear the jam.

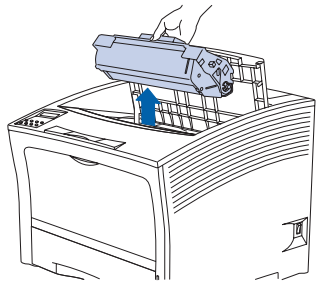
Control Panel Message	Corrective Action	
<p>Tray 1 Jam Open Tray 1</p>		<p><b>1</b> Pull Tray 1 completely out of the printer.</p> <p> <i>To remove the tray from the printer, pull it out, then gently remove it from the printer while lifting it up.</i></p>
		<p><b>2</b> If there is wrinkled paper in the tray, remove it.</p>
<p>Lift/Extend MBF Open Top Cover</p>		<p><b>3</b> Open the multi bypass feeder and extend it:</p> <p><b>1</b> Hold both sides where indicated and tilt it up slightly.</p> <p><b>2</b> Gently lift up and pull out towards you until it stops.</p>
		<p><b>4</b> Open the top cover all the way to the back until it stops.</p> <p> <i>Be sure to remove any paper that may be in the output bin.</i></p>

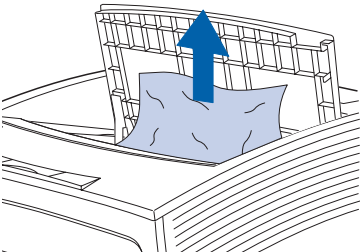
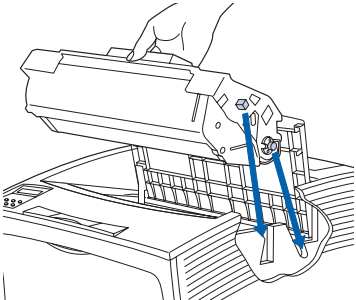

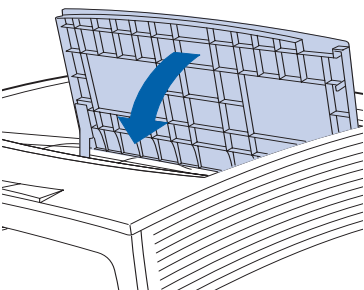
Control Panel Message	Corrective Action
<p data-bbox="154 807 415 864">Remove PrintCart Clear Paper Path</p>	 <p data-bbox="872 222 1279 279"><b>5</b> Pull out the laser print cartridge and set it down on a flat surface.</p> <p data-bbox="919 302 1279 444"> <i>To prevent stains, place the cartridge on a surface covered with old newspaper or some other disposable material.</i></p>
	 <p data-bbox="872 543 1260 635"><b>6</b> Check the area where the laser print cartridge was located and remove any jammed paper.</p> <p data-bbox="915 656 1246 770">Also remove any paper remaining behind the multi bypass feeder, or in the Tray 1 opening.</p>
	 <p data-bbox="872 829 1272 916"><b>7</b> Reinstall the cartridge, inserting its two projecting parts into the printer's guide channels.</p> <p data-bbox="919 939 1279 1025"> <i>Be sure to push the cartridge all the way into the printer.</i></p>
	 <p data-bbox="872 1159 1136 1194"><b>8</b> Close the top cover.</p>

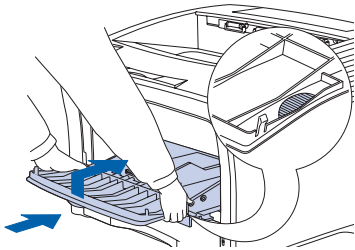
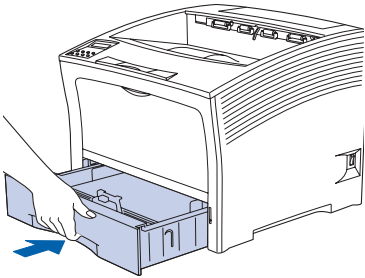
Control Panel Message	Corrective Action
	 <p><b>9</b> Reinsert the multi bypass feeder tray. Hold both sides where indicated and push it straight back until it stops.</p>
	 <p><b>10</b> Reinstall Tray 1. <b>11</b> Check the Control Panel display. If the jam has been cleared and all covers are closed, the Control Panel will display <b>Processing</b> or <b>Ready</b>. If a paper jam message remains, there is still paper jammed in the printer. Refer to Table 5.1 on page 5-6 for instructions.</p>

## Paper Jam While Feeding from 2,000 Sheet Feeder

Follow these steps to clear a jam while feeding from the 2,000 sheet feeder installed either as Tray 2 or Tray 3. (Note: the illustrations below show a feeder installed as Tray 2, but the procedure is the same for a feeder installed as Tray 3.)

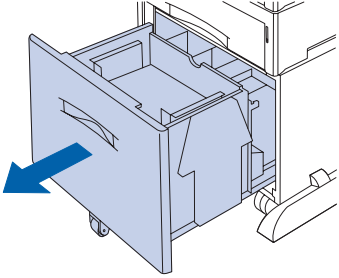
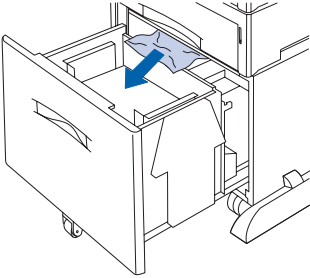

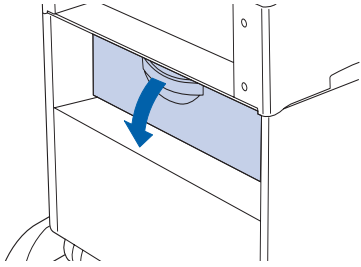
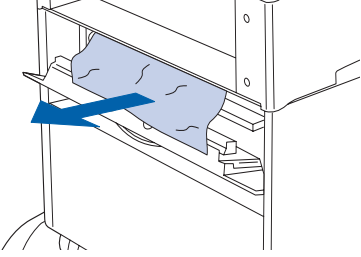
Control Panel Message	Corrective Action
<p>Tray 2 Jam- Open Tray 2 or Tray 3 Jam- Open Tray 3</p>	<p><b>1</b> Open the feeder's front door.</p> 
	<p><b>2</b> Remove any jammed or wrinkled paper.</p> 

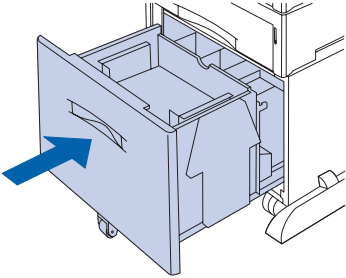
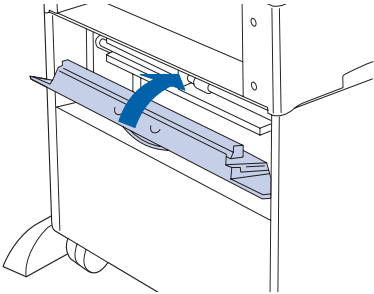
Control Panel Message	Corrective Action
<p data-bbox="154 465 416 524">Open Rear TrayDr Clear Paper Path</p>	<p data-bbox="873 222 1230 256"><b>3</b> Open the feeder's rear cover.</p> 
	<p data-bbox="873 517 1282 576"><b>4</b> Remove any jammed or wrinkled paper.</p> 

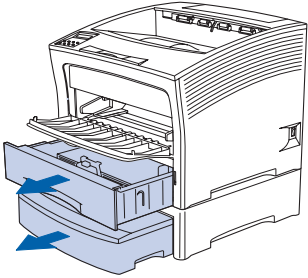

Control Panel Message	Corrective Action
	 <p><b>5</b> Push back the feeder's front door.</p>
	 <p><b>6</b> Close the feeder's rear cover.</p> <p><b>7</b> Check the Control Panel display. If the jam has been cleared and all covers are closed, the Control Panel will display <b>Processing</b> or <b>Ready</b>. If a paper jam message remains, there is still paper jammed in the printer. Refer to Table 5.1 on page 5-6 for instructions.</p>

## Paper Jam While Feeding from 500 Sheet Feeder

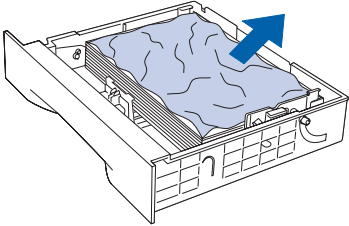
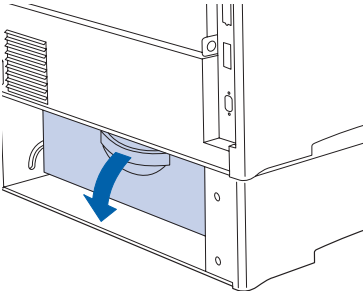

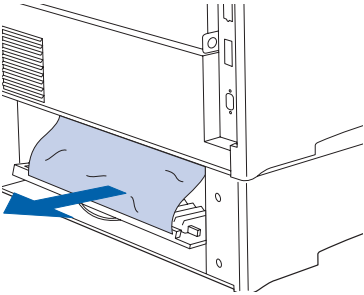
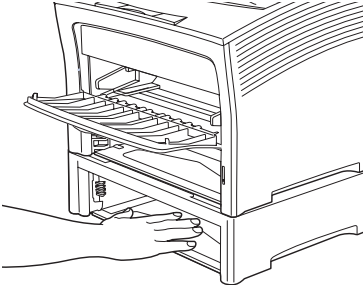
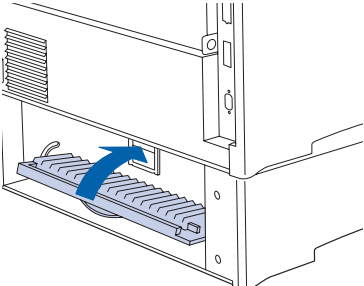

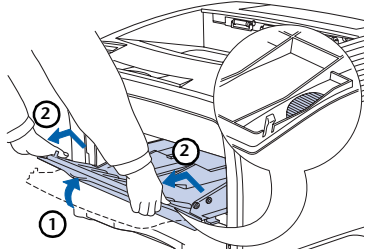
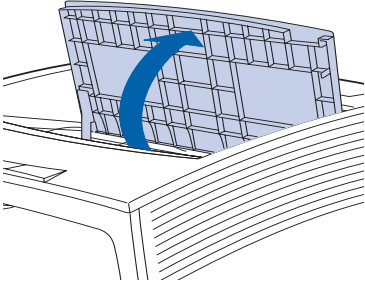
Follow these steps to clear the jam while feeding from a 500 Sheet Feeder installed as Tray 2 or Tray 3. (Note: the illustrations below show one 500 Sheet Feeder installed, but the procedure is the same for a second feeder installed as Tray 3.)

Control Panel Message	Corrective Action
	 <p><b>1</b> Pull all trays completely out of the printer.</p> <p> <i>To remove a tray from the printer, pull it out until it stops, then gently remove it from the printer while lifting it up.</i></p>
<p>Tray 2 Jam Open Tray 2 or Tray 3 Jam Open Tray 3</p>	 <p><b>2</b> If there is wrinkled paper in a tray, remove it.</p>
	 <p><b>3</b> Open the feeder's rear cover.</p>

Control Panel Message	Corrective Action
	<p><b>4</b> Remove any jammed paper.</p> 
	<p><b>5</b> Check inside the printer and remove any jammed paper.</p> 
	<p><b>6</b> Close the feeder's rear cover.</p> 

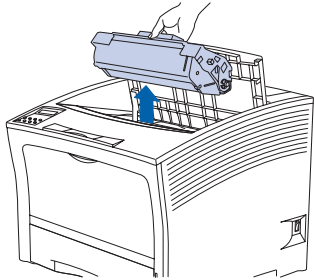
Control Panel Message	Corrective Action
<p data-bbox="154 479 396 538">Lift/Extend MBF Open Top Cover</p>	<div data-bbox="458 227 819 479"></div> <p data-bbox="872 222 1243 279"><b>7</b> Open the multi bypass feeder and extend it:</p> <ol data-bbox="915 302 1289 435" style="list-style-type: none"><li data-bbox="915 302 1289 359"><b>1</b> Hold both sides where indicated and tilt it up slightly.</li><li data-bbox="915 374 1289 435"><b>2</b> Gently lift up and pull out towards you until it stops.</li></ol> <div data-bbox="458 517 819 800"></div> <p data-bbox="872 505 1289 562"><b>8</b> Open the top cover all the way to the back until it stops.</p> <p data-bbox="919 586 1272 670"> <i>Be sure to remove any paper that may be in the output bin.</i></p>

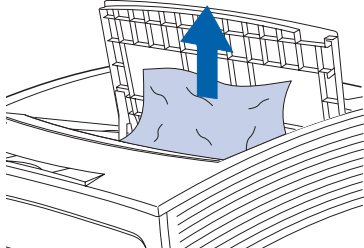
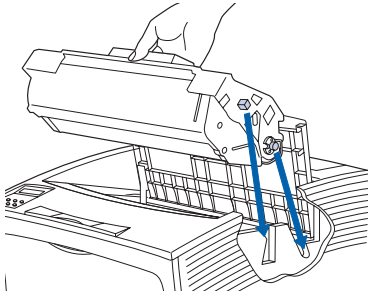

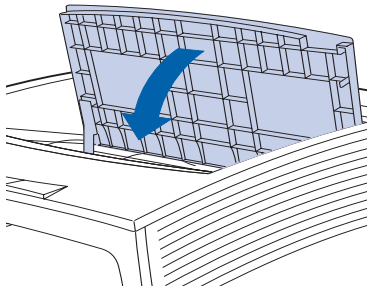

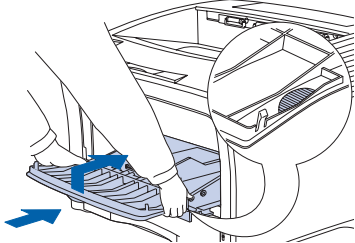
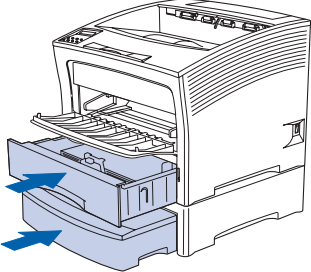

Control Panel Message	Corrective Action
	 <p><b>9</b> Pull out the laser print cartridge and set it down on a flat surface.</p> <p> <i>To prevent stains, place the cartridge on a surface covered with old newspaper or some other disposable material.</i></p>
Remove PrintCart Clear Paper Path	 <p><b>10</b> Check the area where the laser print cartridge was located and remove any jammed paper.</p>
	 <p><b>11</b> Reinstall the cartridge, inserting its two projecting parts into the printer's guide channels.</p> <p> <i>Be sure to push the cartridge all the way into the printer.</i></p>
Close Covers	 <p><b>12</b> Close the top cover.</p>

Control Panel Message	Corrective Action
<p><b>Insert MBF</b></p>	 <p><b>13</b> Reinsert the multi bypass feeder tray.</p> <p>Hold both sides where indicated and push it straight back until it stops.</p>
<p><b>Insert Tray 2</b> or <b>Insert Tray 3</b></p>	 <p><b>14</b> Reinstall all paper trays.</p> <p><b>15</b> Check the Control Panel display. If the jam has been cleared and all covers are closed, the Control Panel will display <b>Processing</b> or <b>Ready</b>. If a paper jam message remains, there is still paper jammed in the printer. Refer to Table 5.1 on page 5-6 for instructions.</p>

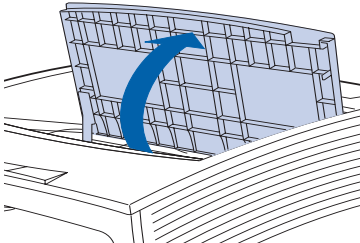
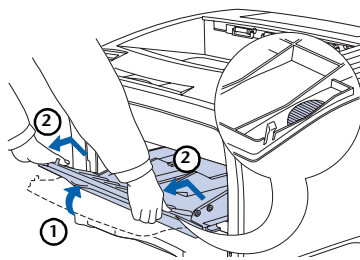
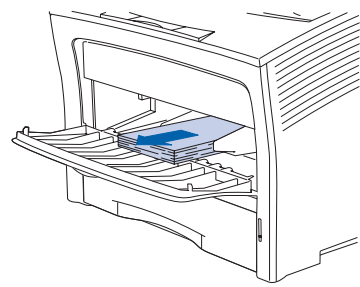
## Paper Jam While Printing

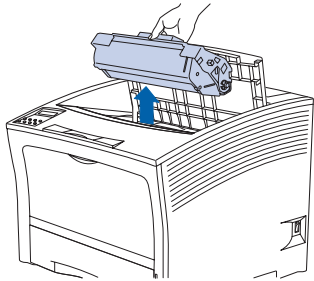
Follow these steps to clear the jam.

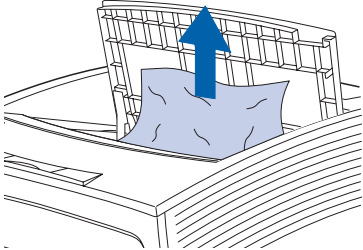
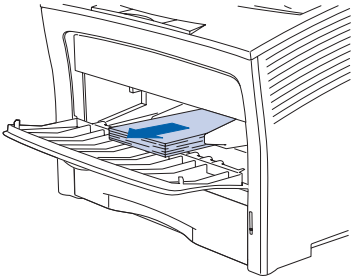
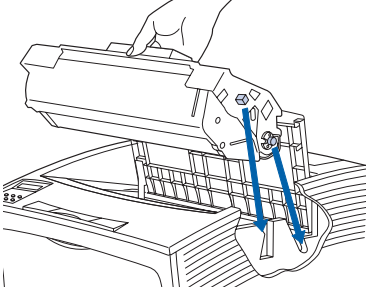
Control Panel Message	Corrective Action	
<p>Paper Jam- Open Top Cover</p>		<ol style="list-style-type: none"> <li data-bbox="871 329 1285 399">1 Open the top cover all the way to the back until it stops.</li> </ol>
<p>Lift/Extend MBF OR Lift/Extend MBF Remove All Paper</p>		<ol style="list-style-type: none"> <li data-bbox="871 616 1285 677">2 Open the multi bypass feeder and extend it:             <ol style="list-style-type: none"> <li data-bbox="913 694 1285 755">1 Hold both sides where indicated and tilt it up slightly.</li> <li data-bbox="913 763 1285 824">2 Gently lift up and pull out towards you until it stops.</li> </ol> </li> </ol>
		<ol style="list-style-type: none"> <li data-bbox="871 894 1285 937">3 Remove all paper.</li> </ol>

Control Panel Message	Corrective Action
<p data-bbox="154 802 414 861">Remove PrintCart Clear Paper Path</p>	 <p data-bbox="871 218 1279 277"><b>4</b> Pull out the laser print cartridge and set it down on a flat surface.</p> <p data-bbox="919 302 1279 444"> <i>To prevent stains, place the cartridge on a surface covered with old newspaper or some other disposable material.</i></p>
	 <p data-bbox="871 541 1262 635"><b>5</b> Check the area where the laser print cartridge was located and remove any jammed paper.</p>
	 <p data-bbox="871 826 1110 861"><b>6</b> Remove all paper.</p>
	 <p data-bbox="871 1145 1273 1239"><b>7</b> Reinstall the cartridge, inserting its two projecting parts into the printer's guide channels.</p> <p data-bbox="919 1263 1279 1347"> <i>Be sure to push the cartridge all the way into the printer.</i></p>

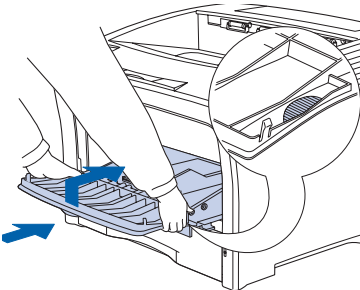
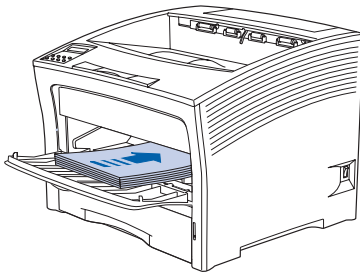
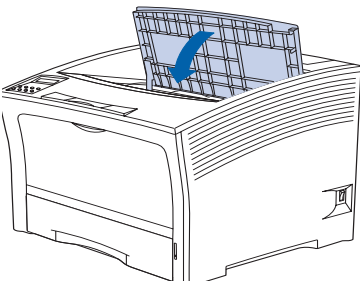
Control Panel Message	Corrective Action	
<p><b>Insert MBF</b></p>		<p><b>8</b> Reinsert the multi bypass feeder tray.</p> <p>If it was extended, hold both sides where indicated and push it straight back until it stops.</p>
<p><b>Manual Feed</b></p>		<p><b>9</b> Reload the multi bypass feeder.</p>
<p><b>Close Covers</b></p>		<p><b>10</b> Close the top cover.</p> <p><b>11</b> Check the Control Panel display. If the jam has been cleared and all covers are closed, the Control Panel will display <b>Processing</b> or <b>Ready</b>. If a paper jam message remains, there is still paper jammed in the printer. Refer to Table 5.1 on page 5-6 for instructions.</p>

## Paper Jam Because of Mismatch between Expected and Actual Size Fed

Follow these steps to clear the jam.

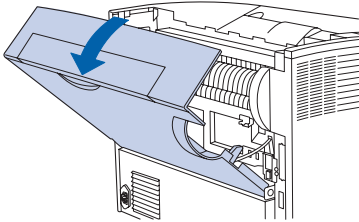
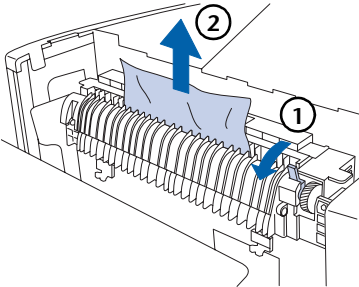
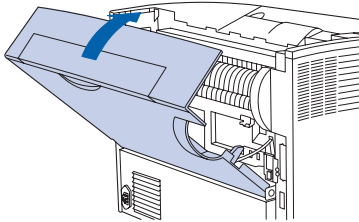
Control Panel Message	Corrective Action	
<p>Paper Size Jam- Open Rear Cover</p>		<ol style="list-style-type: none"> <li>1 Open the rear cover.</li> </ol> <p><b>!! Be careful not to touch the fuser. It becomes very hot from printing.</b></p> <p>Load any tray with the size needed for the job printing. Check to make sure the multi bypass feeder size menu is correctly set.</p>
<p>Clear Paper Path</p>		<ol style="list-style-type: none"> <li>2 Carefully pull out any jammed paper:             <ol style="list-style-type: none"> <li>1 Open the lever on the side of the fuser.</li> <li>2 Pull the jammed paper straight up and out.</li> </ol> </li> </ol>
<p>Clear Paper Path</p>		<ol style="list-style-type: none"> <li>3 Close the rear cover.</li> <li>4 Check the Control Panel display. If the jam has been cleared and all covers are closed, the Control Panel will display <b>Processing</b> or <b>Ready</b>. If a paper jam message remains, there is still paper jammed in the printer. Refer to Table 5.1 on page 5-6 for instructions.</li> </ol>

# Solving Printing Problems

If you have any problems with the operation of your printer, refer to Table 5.2 for suggested remedies.

**Table 5.2 Printer Operation Problems**

Problem	Action
<p>The printer will not print at all, or a file sent from the client/server will not print.</p>	<ul style="list-style-type: none"> <li>• Check with your network administrator to see that the printer is powered up, connected to the network and that the network is operational.</li> <li>• Check Control Panel messages for “Paper Jam,” “Close Covers,” etc.</li> <li>• If the port (parallel or network) the printer is connected to is disabled, enable it. Check the Configuration Sheet for the port you are using to see if the Port Enable item in the appropriate Interface Menu is set to <i>On</i>. If it is set to <i>Off</i>, set it to <i>On</i> and try again.</li> <li>• If the printer has printed recently, do the following:             <ul style="list-style-type: none"> <li>- Attempt to print a Configuration Sheet. If it does not print, contact your customer support center.</li> <li>- If the Configuration Sheet prints, check to see that the printer is configured properly.</li> <li>- If the printer is configured properly, check the Configuration Sheet to confirm that the correct emulation is (PDL) enabled for the port or protocol you are using.</li> <li>- If the correct emulation is (PDL) enabled and the printer continues not to print, contact your customer support center.</li> </ul> </li> </ul>

Table 5.2 Page 1 of 4

Table 5.2 Printer Operation Problems (continued)

Problem	Action
A printed page does not look as expected.	<ul style="list-style-type: none"> <li>• Make certain that the software application you are using to create your print job is configured properly. Refer to your software documentation.</li> <li>• Make sure the correct driver is being used.</li> <li>• Print a configuration sheet. If it does not print correctly, contact your customer support center.</li> <li>• Send a file containing PCL or PostScript commands to the printer. <ul style="list-style-type: none"> <li>- If your page prints as it should, your printer and interface are functioning properly.</li> <li>- If your information prints correctly, but doesn't look right, you may have: <ul style="list-style-type: none"> <li>- An error in your command sequence/operator.</li> <li>- A missing downloaded font.</li> <li>- A mismatched printer option against your host formatting.</li> </ul> </li> <li>- Command errors may be identified by looking at your input file. You can determine which fonts are in the system by printing a PCL or PS Font List. You can verify your data setup by printing a Configuration Sheet and checking your printer setup.</li> </ul> </li> </ul>
The requested font for the job does not print.	<p>Print a PCL Font List, or PostScript Font List if the job is PostScript.</p> <ul style="list-style-type: none"> <li>• If fonts print on the Font List, your print job may need correcting.</li> <li>• If fonts do not print on the Font List, reload the fonts and print another PCL or PostScript Font List.</li> </ul>

Table 5.2 Page 2 of 4



Table 5.2 Printer Operation Problems (continued)

Problem	Action
PostScript commands are printed instead of the PostScript job.	<ul style="list-style-type: none"> <li>• Make certain that the software application you are using to create your job is configured properly. Refer to your software documentation.</li> <li>• The job sent to the printer might have included an incorrect header, and therefore, not have indicated that a PostScript job was being sent. <ul style="list-style-type: none"> <li>- Check your software to make sure the PostScript header file is being sent to the printer.</li> </ul> </li> <li>• Set the PS Errors item in the System Menu to <i>On</i> and resend the job. <ul style="list-style-type: none"> <li>- If an error page prints, there is a problem in the PostScript coding. Correct the coding problem and resend the job. Asking for features not available can cause a configuration error.</li> <li>- If the job still does not print and an error page was not printed, the job may require additional memory.</li> </ul> </li> </ul>

Table 5.2 Page 3 of 4

Table 5.2 Printer Operation Problems (continued)

Problem	Action
A PostScript or PCL job fails to print.	<ul style="list-style-type: none"> <li>• Check that you are using the correct PostScript or PCL printer driver.</li> <li>• For a PostScript job, set the PS Errors item in the PostScript Menu to <b>On</b> and resend the job. <ul style="list-style-type: none"> <li>- If an error page prints, there is a problem in the PostScript coding. Correct the coding problem and resend the job. Asking for features not available can cause a configuration error.</li> <li>- If the job still does not print and an error page was not printed, the job may require additional memory. See the <i>Supplies/Options Guide</i> provided with your printer for ordering more memory.</li> </ul> </li> <li>• For a PCL job, do the following: <ul style="list-style-type: none"> <li>- Check the output for PCL errors.</li> <li>- If there is a problem in the PCL coding, correct the coding problem and resend the job.</li> <li>- If there is no error message, resend the job.</li> <li>- If the job still does not print and the error message says "out of memory", the job may require additional memory. See the <i>Supplies/Options Guide</i> provided with your printer for ordering more memory.</li> </ul> </li> </ul>

Table 5.2 Page 4 of 4

# Solving Print Quality Problems

If you have any problems with your printer's printed output, refer to Table 5.3 for suggested remedies.



*The cases listed in Table 5.3 are probable cases only, and may not represent all of the possible cases which may occur under actual operating conditions. If you experience a problem which does not seem to fall under any of the cases listed in this table, or if you are concerned about any other aspect of printer operation, contact your customer support center.*

**Table 5.3 Print Quality Problems**

Problem	Possible Cause(s)	Corrective Action(s)
<b>Light/faint prints</b> Overall image is lighter than normal. 	Draft Mode.	Turn off Draft Mode.
	Toner level low/empty.	Remove the print cartridge carefully and vigorously shake it several times, then reinstall it. (This may help redistribute the remaining toner before having to replace the cartridge.)
	Damp paper stock.	Replace paper stock.

Table 5.3 Page 1 of 8

**Table 5.3 Print Quality Problems** (continued)

Problem	Possible Cause(s)	Corrective Action(s)
<p><b>Blank Prints</b></p> <p>Entire printed page is blank with no visible print.</p> 	<p>If just installed, the laser print cartridge insert (tape) may still be in place.</p> <p>Multiple sheets are being fed from the paper tray at the same time.</p> <p>No printable data received from computer.</p> <p>Defective laser print cartridge or low on toner.</p>	<p>Remove the tape insert. Refer to Step 4 on page 4-5.</p> <p>Remove the paper from the paper tray and fan it. Ensure that paper is correctly loaded in the tray with edges under metal corners.</p> <p>Print a Test Print. If the Test Print is normal, check the following:</p> <ul style="list-style-type: none"> <li>• Interface cable between computer and printer</li> <li>• Printer set up and application software</li> </ul> <p>If the Test Print is blank, contact your customer support center.</p> <p>Replace the laser print cartridge.</p>
<p><b>Black prints</b></p> <p>The page is entirely black.</p> 	<p>Defective laser print cartridge, or the print cartridge is at its end of life.</p> <p>Printer power supply has failed.</p>	<p>Replace the laser print cartridge.</p> <p>Contact your customer support center for service.</p>

Table 5.3 Page 2 of 8

Table 5.3 Print Quality Problems (continued)

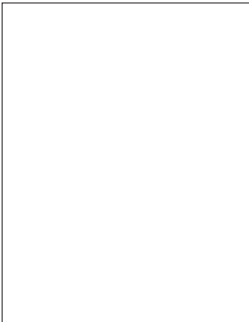
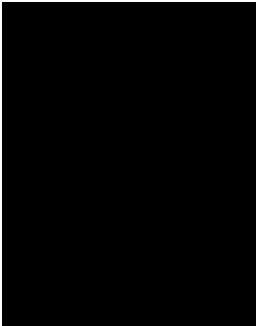

Problem	Possible Cause(s)	Corrective Action(s)
<p><b>Spot deletions</b></p> <p>Areas of the print are extremely light or missing.</p> 	<p>Damp paper stock.</p> <p>Defective laser print cartridge, or the cartridge is at its end of life.</p>	<p>Replace the paper stock.</p> <p>Replace the laser print cartridge.</p>
<p><b>Vertical line deletions</b></p> <p>Localized print deletions forming narrow lines running in the direction of paper movement.</p> 	<p>Laser print cartridge not installed correctly</p> <p>Paper debris in laser print cartridge area.</p> <p>Defective laser print cartridge, or the cartridge is at its end of life</p>	<p>Remove then reinstall the laser print cartridge.</p> <p>Remove laser print cartridge and inspect for paper debris and remove.</p> <p>Replace the laser print cartridge.</p>

Table 5.3 Page 3 of 8

**Table 5.3** Print Quality Problems (continued)

Problem	Possible Cause(s)	Corrective Action(s)
<p><b>Horizontal line deletions</b></p> <p>Localized print deletions appearing as bands running across the page perpendicular to the direction of paper movement.</p> <div data-bbox="154 513 408 836" style="border: 1px solid black; padding: 10px; text-align: center;"> <p>PRINTED IMAGE</p> <p>PRINTED IMAGE</p> </div>	<p>Defective paper stock, creases, folds, etc.</p>	<p>Replace the paper stock.</p>
<p><b>Vertical dark streaks</b></p> <p>Black lines running across the print in the direction of paper movement.</p> <div data-bbox="159 1045 411 1371" style="border: 1px solid black; padding: 10px; text-align: center;"> <p>PRINTED IMAGE</p> </div>	<p>Defective laser print cartridge, or the cartridge is at its end of life.</p> <p>Defective Fuser.</p>	<p>Replace the laser print cartridge.</p> <p>Replace the Fuser. See the <i>System Administrator Guide</i> on the Product CD for ordering and installation instructions.</p>

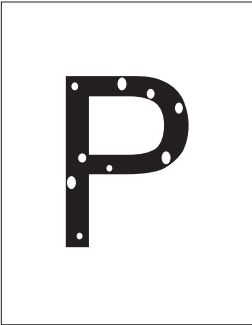
Table 5.3 Page 4 of 8

Table 5.3 Print Quality Problems (continued)



Problem	Possible Cause(s)	Corrective Action(s)
<p><b>Repetitive horizontal dark streaks</b></p> <p>Black lines running across the page perpendicular to the direction of paper movement.</p> 	<p>Contaminated paper path.</p> <p>Defective laser print cartridge, or the cartridge is at its end of life.</p>	<p>Print several blank sheets of paper to remove any toner accumulations.</p> <p>Replace the laser print cartridge.</p>
<p><b>Dark spots/marks</b></p> 	<p>Defective fuser.</p>	<p>Replace the fuser.</p>

Table 5.3 Page 5 of 8

**Table 5.3 Print Quality Problems** (continued)

Problem	Possible Cause(s)	Corrective Action(s)
<p><b>Unfused or partially fused image</b></p> <p>The printed image is not fully fused to the paper and easily rubs off.</p> 	<p>Damp paper stock.</p> <p>Heavy or unusual paper stock.</p> <p>Defective Fuser.</p>	<p>Replace paper stock.</p> <p>Use only approved paper/media. (See Table 2.1 on page 2-4).</p> <p>Replace the Fuser. See the <i>System Administrator Guide</i> on the Product CD for ordering and installation instructions.</p>
<p><b>Wrinkled prints</b></p> <p>Prints are wrinkled, creased, or torn.</p> 	<p>Poor paper condition.</p> <p>Paper is damp.</p> <p>Paper debris in path.</p> <p>Paper skew.</p> <p>Fuser is at its end of life</p>	<p>Inspect/replace the paper stock.</p> <p>Replace paper stock.</p> <p>Clear paper path.</p> <p>Check paper tray guides.</p> <p>Replace the Fuser. See the <i>System Administrator Guide</i> on the Product CD for ordering and installation instructions.</p>

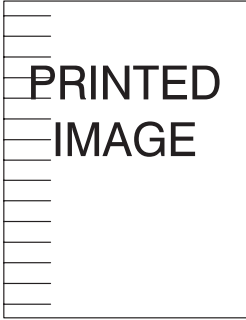
Table 5.3 Page 6 of 8



Table 5.3 Print Quality Problems (continued)

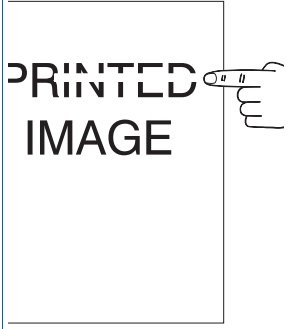
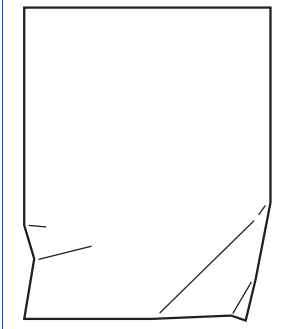

Problem	Possible Cause(s)	Corrective Action(s)
<b>Blurred prints</b> Image is blurred at the edges. 	Poor paper condition.	Inspect/replace the paper stock.
	Paper is damp.	Replace the paper stock.
<b>Random deletions</b> Random light areas and deletions. 	Poor paper condition.	Inspect/replace the paper stock.
	Paper is damp.	Replace the paper stock.

Table 5.3 Page 7 of 8

**Table 5.3** Print Quality Problems (continued)

Problem	Possible Cause(s)	Corrective Action(s)
<p><b>Grainy Graphics</b></p> <p>A graphic image is coarse or grainy (like a brick or checkerboard pattern) rather than a smooth halftone.</p> 	<p>The printer tried to print a complex graphic image with inadequate memory.</p>	<p>Refer to the <i>System Administrator Guide</i> on the Product CD for a discussion of memory requirements.</p>
<p><b>Broken Page/Page Too Complex</b></p> <p>The printed image is missing all of the image print after a straight line.</p> 	<p>The printer tried to print a complex graphic image with inadequate memory.</p>	<p>Refer to the <i>System Administrator Guide</i> on the printer's CD-ROM for a discussion of memory requirements.</p>

Table 5.3 Page 8 of 8

## Additional Sources of Troubleshooting Assistance

---

If you encounter an error message, problem, or print defect that you are unable to correct by using your User Guide or the On-Line Help system, you may need to contact your System Administrator or refer to the *System Administrator Guide* on the Product CD. For more complicated problems, contact your customer support center for assistance.

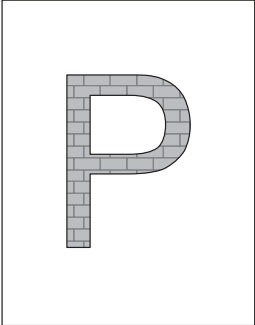
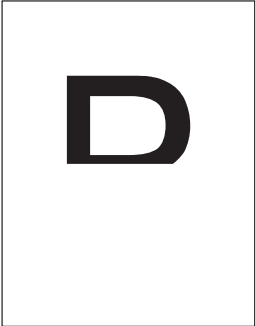

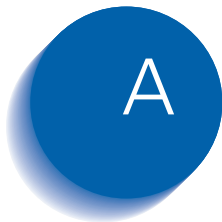

# *Printer Specifications*

*Printer Specifications* ..... A-2

# Printer Specifications

<b>Rated Print Speed</b>	20 ppm 28 ppm
<b>Image Resolution</b>	True 1200 dpi (half speed) 1200 dpi Image Quality 600 dpi 300 dpi (PCL5e)
<b>Processor</b>	Motorola Power PC 200 MHz processor
<b>Maximum Monthly Duty Cycle</b>	20 ppm up to 100,000 Impressions per month 28 ppm up to 130,000 Impressions per month
<b>Nominal Voltage</b>	100 – 120 VAC or 220 – 240 VAC
<b>Nominal Frequency</b>	50 Hz or 60 Hz
<b>Power Consumption</b>	Less than 1.1 kW during operation Power Saver mode operational after specified period of not printing (15, 30, 60, 90, 120, 180 minutes, or off)
<b>Noise Level</b>	49.5 dB (A) continuous running 35 dB (A) in stand by
<b>Temperature</b>	5 – 35 degrees C during operation (41 – 95 degrees F)
<b>Relative Humidity</b>	15% to 85% during operation (Non-condensing)
<b>Dimensions</b>	20¼ in, (W) x 18 in (D) x 15 in (H) 490mm (W) x 460mm(D) x 395mm(H)
<b>Weight</b>	27 KG / 60 lbs.
<b>Memory Capacity</b>	32 MB standard 192 MB maximum

**Standard Features**

- 500-sheet Standard Input Tray
- 150-sheet Multi Bypass Feeder
- 500-sheet Standard Face-down Output Bin
- IEEE 1284 Bidirectional Parallel Interface
- USB Interface
- CentreWare Administration Software
- Unidirectional Windows Drivers
- Internet Printer Administration Embedded HTTP Server
- PostScript 3 Language

**Available Options**

- 16 MB DIMM
- 32 MB DIMM
- 64 MB DIMM
- 8 MB Flash DIMM
- Hard Disk
- 10Base2 Ethernet Network Interface Card
- Token Ring Network Interface Card
- Serial RS232-C Card
- 500 Sheet Feeder – A4/Letter Tray
- 500 Sheet Feeder – A3/Ledger Tray
- 2000 Sheet Feeder – A4/Letter Tray
- Duplex Module
- 500 Sheet Offset Catch Tray





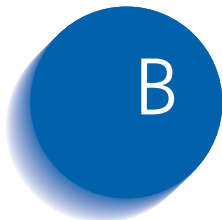

## *Notices and Certifications*

<i>FCC Notices...USA</i> .....	<i>B-2</i>
<i>Radio Frequency</i> .....	<i>B-2</i>
<i>Certifications...Canadian</i> .....	<i>B-4</i>
<i>60 HZ, 115V</i> .....	<i>B-4</i>
<i>European Markets</i> .....	<i>B-5</i>
<i>CE</i> .....	<i>B-5</i>
<i>EN55022</i> .....	<i>B-7</i>
<i>Safety Extra Low Voltage Safety Approval</i> .....	<i>B-8</i>

## FCC Notices...USA

---

### Radio Frequency

This equipment generates, uses, and can radiate radio frequency energy, and, if not installed and used in accordance with the instruction manuals, may cause interference with radio communications. The equipment, in its base configurations (See the Caution Statement on page B-3.), has been tested and found to comply with the limits for a Class B digital device pursuant to Part 15 of the FCC rules, which are designed to provide reasonable protection against such interference, when the equipment is operated in a residential environment. However, there is no guarantee that interference will not occur in a particular installation. If the equipment does cause harmful interference with radio or television reception, which can be determined by turning the equipment off and on, the user is encouraged to try to correct the interference by one or more of the following measures:

- Reorient or relocate the receiving antenna.
- Increase the separation between the equipment and the receiver.
- Connect the equipment into an outlet on a circuit different from that to which the receiver is connected.
- Consult the dealer or a experienced radio/TV technician for help.

Changes or modifications to this equipment not specifically approved by the manufacturer may void the authority granted by the FCC to operate this equipment.

Shielded cables must be used with this equipment to maintain compliance with FCC regulations.

The manufacturer is not responsible for any radio or television interference caused by using other than recommended cables or by unauthorized changes or modifications to this equipment. Unauthorized changes or modifications could void the user's authority to operate this equipment.

To assure compliance with FCC regulations on electromagnetic interference, use a properly shielded and grounded cable. Use of a substitute cable not properly shielded and grounded may result in a violation of FCC regulations.



*The Class B base configuration uses the parallel cable for communication. Use of either or both USB and Ethernet cables denotes Class A operation not intended for home use.*

---

## Certifications...Canadian

---

### **60 HZ, 115V**

The equipment is listed by the Underwriters Laboratories, UL 1950, certified by Canadian Standards Association, CSA22.2, No. 950

# European Markets

---

**CE** The CE marking applied to this product symbolises Xerox Ltd Declaration of Conformity with the following applicable Directives of the European Union.

Council Directive 73/23/EC amended by Council Directive 93/68/EC, on the harmonisation of the laws of the Member States related to equipment designated for use within certain voltage limits.

Council Directive 89/336/EC, approximation of the laws of the Member States related to electromagnetic compatibility.

When applicable: Council Directive 99/5/EC, on the harmonisation of the laws of the Member States related to radio and telecommunications terminal equipment.

A full declaration defining the relevant Directives and referenced standards can be obtained from your Xerox Ltd representative

## **WARNING (Class A products according to EN55022)**

This is a Class A product. In a domestic environment, this product may cause radio interference in which case, the user may be required to take adequate measures.

## **WARNING (Immunity)**

In order to allow this product to operate in proximity to Industrial, Scientific, and Medical (ISM) equipment, the external radiation from the ISM equipment may have to be limited or special mitigation measures taken.

Changes or modifications to this equipment not specifically approved by the manufacturer may result in noncompliance with one or more of the directives listed above.

Shielded cables must be used with this equipment to maintain compliance with the EMC directive (89/336/EEC).

## EN55022

Configuration	Specification
Base Printer	EN55022-B
Base Printer with Token Ring	EN55022-A

# Safety Extra Low Voltage Safety Approval

---

The printer's printing system is in compliance with various governmental agencies and national safety regulations. All system ports meet the requirements for Safety Extra Low Voltage (SELV) circuits for connection to customer-owned devices and networks.

Additions of customer-owned or third-party accessories attached to the system must meet or exceed the requirements listed above.

Since this system consists of several modules requiring external connection, it must be installed per the manufacturer's installation procedure.



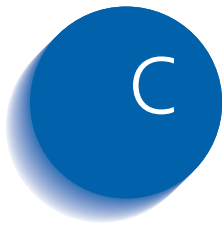

# *Printer Options*

*Optional Equipment* ..... C-2



## Optional Equipment

---

The optional equipment described in this User guide allow you to add special features to your printer or upgrade your printer system to meet your particular needs. Table C.1 on page C-3 provides a brief description of each enhancement available. The part number needed to place an order can be found on the *Supplies/Options Guide* that came with the printer.



*Normally, the optional equipment kits come with installation instructions. However, the memory upgrade kit instructions are included in this appendix because they are not included with the memory kits.*

---

To order any of the equipment listed below, see the separate *Supplies/Options Guide* or call your authorized Xerox reseller.

Table C.1 Optional Equipment

Optional Kits	Use
<b>Hard Drive</b>	Allows for secure job and proof job printing, storage of fonts and overlays, and increases the productivity of multiple-page jobs via electronic pre-collation.
<b>500 sheet feeder with option of A3/Ledger size tray or A4/Letter size tray</b>	Additional media tray and feeder. The tray is interchangeable with Tray 1 or any 500 Sheet Feeder.
<b>2,000 Sheet Feeder</b>	Enables loading of up to 2,000 sheets of paper of A4 or Letter size. The 2000 Sheet Feeder can be attached to the printer directly, or be installed together with the optional 500-sheet paper feeder.
<b>Offset Catch Tray</b>	Enables stacking of up to 500 sheets of paper with the ability to offset successive jobs (or multiple copies within the same job) from each other. Supplements the standard output bin.
<b>Duplex Unit</b>	Allows printing on both sides of the sheet of paper.
<b>Ethernet 10Base2 Card</b>	Provides 10Base2 MBPS Ethernet network capability for IPX/SPX, TCP/IP, DLC/LLC, SNMP and EtherTalk protocols.
<b>Token Ring Card</b>	Provides network capability utilizing IPX/SPX, TCP/IP, DLC/LLC, SNMP and TokenTalk protocols.
<b>Serial Card</b>	Provides an RS232C interface, using a DB9 connector. The serial port is bi-directional—i.e., it can receive data from the computer as well as transmit data from the printer to the computer.

Table C.1 Page 1 of 2

Table C.1 Optional Equipment (continued)

Optional Kits	Use
<b>Memory (DIMMs)</b>	<p>Increases the font capability and enhances the speed of data transfer and complex page processing.</p> <p>Memory kits are available in three configurations, packaged in single units each:</p> <ul style="list-style-type: none"><li>- 64 MB</li><li>- 32 MB</li><li>- 16 MB</li></ul> <p>The printer utilizes industry standard DIMMs with the following specifications:</p> <ul style="list-style-type: none"><li>- 162 pin, 60 ns (or faster) DIMMs</li><li>- 32 bit wide (non parity)</li><li>- EDO</li></ul>
<b>Flash Memory (DIMMs)</b>	Provides 8 MB of memory for storage of downloaded fonts and overlays.

Table C.1 Page 2 of 2

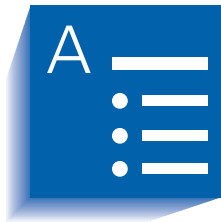

## Index

### A

- A3 size paper
  - Dimensions • 2-4
  - Supported trays/  
bins • 2-4
- A4 size paper
  - Dimensions • 2-4
  - Supported trays/  
bins • 2-4
- A5 size paper
  - Dimensions • 2-4
  - Supported trays/  
bins • 2-4
- A6 size paper
  - Dimensions • 2-4
  - Supported trays/  
bins • 2-4

### B

- B4-JIS size paper
  - Dimensions • 2-4
  - Supported trays/  
bins • 2-4
- B5-JIS size paper
  - Dimensions • 2-4
  - Supported trays/  
bins • 2-4

### C

- CDs • 1-9 → 1-11
- Cleaning the printer • 4-2
- Collating output
  - PCL jobs • 3-11
  - PostScript jobs • 3-24
- Com10 size envelopes
  - Dimensions • 2-4
  - Supported trays/  
bins • 2-4
- Configuration Sheet
  - Printing • 3-57
- Connectivity • 1-4
- Control Panel
  - Display • 3-36
  - Indicator lights • 3-37
  - Keys • 3-38 → 3-39
  - Location • 1-6
  - Menu
    - options • 3-40 → 3-54
    - Using • 3-35 → ??
- Custom Paper Sizes
  - Examples • 3-62
- Custom paper
  - sizes • 3-61 → ??
  - Configuring • 3-61

## D

- C5 size envelopes
  - Dimensions • 2-4
  - Supported trays/bins • 2-4

## D

- Demo Page
  - Printing • 3-57
- Disk Directory
  - Printing • 3-57
- DL size envelopes
  - Dimensions • 2-4
  - Supported trays/bins • 2-4
- Draft Mode • 3-19, 3-30
- Drivers
  - Configuring • 3-5
  - Installing • 3-5
  - PCL emulation
    - Description • 3-4
    - Features • 3-6
    - Using • 3-7 → 3-20
  - PostScript
    - Description • 3-5
    - Features • 3-6
    - Using • 3-21 → 3-34
- Duplex printing • 1-4, 3-59 → 3-60
  - PCL driver • 3-10
  - PostScript driver • 3-23
- Duplex printing unit
  - Location • 1-8

## E

- Ethernet 10/100 Card • C-3
- Executive size paper
  - Dimensions • 2-4
  - Supported trays/bins • 2-4

## F

- Flash memory • C-4
- Folio size paper
  - Dimensions • 2-4
  - Supported trays/bins • 2-4
- Fonts • 1-5
- Fuser
  - Location • 1-7

## H

- Hard Drive • C-3

## I

- Interface connectors
  - Location • 1-6

## L

- Labels
  - Sizes supported • 2-4
  - Supported Trays/Bins • 2-4
- Laser print cartridge
  - Location • 1-7
  - Replacing • 4-3 → 4-5
- Ledger size paper
  - Dimensions • 2-4
  - Supported trays/bins • 2-4
- Legal size paper
  - Dimensions • 2-4
  - Supported trays/bins • 2-4
- Letter size paper
  - Dimensions • 2-4
  - Supported trays/bins • 2-4

## M

- Maintenance Kit • 4-6
- Memory Upgrade • C-4
- Menu Map
  - Printing • 3-57
- Mirror images • 3-29
- Monarch size envelopes
  - Dimensions • 2-4
  - Supported trays/bins • 2-4
- Multi bypass feeder
  - Capacity • 2-4
  - Location • 1-6, 1-7
  - Paper loading • 2-16 → 2-18
  - Paper sizes supported • 2-4, 2-5

## N

- Negative images • 3-29

## O

- Offset Catch Tray
  - Capacity • 2-4
  - Location • 1-8
  - Paper sizes supported • 2-4, 2-5
  - Using • 3-58
- Offsetting output • 3-12, 3-25, 3-58
- Overlays • 3-20

## P

- Page Description Languages • 1-5
- Page overlays • 3-20
- Paper
  - Jams
    - See Paper jams
    - Selecting for use • 2-2
  - Sizes supported
    - A3/Ledger size tray • 2-4
    - A4/Letter size tray • 2-4
    - Multi bypass feeder • 2-4, 2-5
    - Offset Catch Tray • 2-4, 2-5
    - Standard output bin • 2-4, 2-5
    - Tray 1 • 2-4, 2-5
    - Tray 2 • 2-4, 2-5
    - Tray 3 • 2-4, 2-5
    - 2,000 sheet feeder • 2-4
  - Unacceptable for use • 2-3
  - Weights supported • 2-2
- Paper amount indicator
  - Location • 1-6
- Paper jams • 5-5 → 5-26
  - Causes • 5-5
  - Clearing • 5-5 → 5-26
  - Control Panel messages • 5-6
- Paper loading • 2-7 → 2-18
  - A3/Ledger size tray • 2-10 → 2-13
  - A4/Letter size tray • 2-7 → 2-9
  - Multi bypass feeder • 2-16 → 2-18
  - 2,000 sheet feeder • 2-14 → 2-15
- Paper orientation
  - A3/Ledger size tray • 2-11
  - A4/Letter size tray • 2-8
  - Multi bypass feeder • 2-17
  - 2,000 sheet feeder • 2-15
- Paper output • 1-4
- Paper sources • 1-3

- Paper support and stopper
    - Location • 1-6
  - Password jobs
    - Deleting • 3-56
    - Printing • 3-55
  - PCL emulation
    - Drivers
      - Description • 3-4
      - Using • 3-7 → 3-20
  - PCL Font List
    - Printing • 3-57
  - PCL 5e driver
    - See Drivers, PCL emulation
  - PCL 6 driver
    - See Drivers, PCL emulation
  - PostScript driver
    - See Drivers, PostScript
  - PostScript Font List
    - Printing • 3-57
  - Power cord receptacle
    - Location • 1-6
  - Power switch
    - Location • 1-6
  - Print speeds • 1-5
  - Printer cleaning • 4-2
  - Printer components • 1-6 → 1-8
  - Printer drivers
    - See Drivers
  - Printer Management Software CD • 1-11
  - Printer reports
    - Printing • 3-57
    - Types • 3-57
  - Problems
    - See Troubleshooting
  - Product CD • 1-11
  - Proof printing
    - PCL jobs • 3-9
    - PostScript jobs • 3-22
- R**
- Rear cover
    - Location • 1-6, 1-7

## S

Resolution • 1-5

## S

Secure printing

PCL jobs • 3-8

PostScript jobs • 3-21

Serial card • C-3

Standard output bin

Capacity • 2-4

Location • 1-6

Paper sizes supported • 2-4, 2-5

Statement size paper

Dimensions • 2-4

Supported trays/bins • 2-4

## T

Test Print

Printing • 3-57

Token Ring Card • C-3

Toner

*See* Laser print cartridge

Top cover

Location • 1-6, 1-7

Transparencies

Sizes supported • 2-4

Supported Trays/Bins • 2-4

Tray 1

Capacity • 2-4

Location • 1-6

Paper sizes supported • 2-4, 2-5

Tray 2

Capacity • 2-4

Paper sizes supported • 2-4, 2-5

Tray 3

Capacity • 2-4

Paper sizes supported • 2-4, 2-5

Troubleshooting

Assistance • 5-39

Operation problems • 5-27 → ??

Paper jams • 5-5 → 5-26

Print quality problems • 5-31 → 5-38

TrueType fonts

PCL jobs • 3-16

PostScript jobs • 3-31

## U

Universal Tray • C-3

## V

Ventilation slots

Location • 1-6

## W

Watermarks

PCL jobs • 3-19

PostScript jobs • 3-27

## Numerics

2,000 sheet feeder

Capacity • 2-4

Location • 1-8

Paper loading • 2-14 → 2-15

Paper sizes supported • 2-4

500 sheet feeder

Location • 1-8



## Free Manuals Download Website

<http://myh66.com>

<http://usermanuals.us>

<http://www.somanuals.com>

<http://www.4manuals.cc>

<http://www.manual-lib.com>

<http://www.404manual.com>

<http://www.luxmanual.com>

<http://aubethermostatmanual.com>

Golf course search by state

<http://golfingnear.com>

Email search by domain

<http://emailbydomain.com>

Auto manuals search

<http://auto.somanuals.com>

TV manuals search

<http://tv.somanuals.com>