



Update Alert: Firmware updates are posted on the web on a regular basis. We recommend that you check for firmware and/or install guide updates prior to installing this product.

Installation Guide



This guide supports the installation of a DBALL in Remote Start Ready (RSR) mode with or without a Plug & Play (CHTHD1 or CHTHD2) T-Harness (Optional). This solution offers three (3) configuration options to control your system; 3x OEM Lock Remote Start Activation*, RF Kit or SmartStart (all sold separately). Refer to page 24 for a list of RF kits and their part numbers.

*3x OEM Lock Remote Start Activation is a feature that allows users to control the aftermarket remote starter using the factory (OEM) remote control. See page 2 for more information.

Note: Only available on certain models, check the Vehicle Application Guide for compatibility with specific year and model.



Remote Start Ready (RSR) is a function that enables the interface module to remote start the vehicle completely on its own. Consequently, there is no need for an aftermarket or an OEM remote starter in order to start the vehicle from a distance. An RSR solution is commonly referred to as a Standalone installation.



Important!

This product is NOT compatible with vehicles equipped with a manual transmission.

Index

Important Information.....	02
Vehicle Application Guide.....	03
Installation	
Type 1a (with T-Harness).....	04
Type 1b (without T-Harness).....	05
Type 2a (with T-Harness).....	07
Type 2b (without T-Harness).....	08
Type 3a (with T-Harness).....	10
Type 3b (without T-Harness).....	11
Type 4a (with T-Harness).....	13
Type 4b (without T-Harness).....	14
Type 5 (without T-Harness).....	16
Programming	
Module Programming and Reset for Installation Types 1 to 4.....	18
Module Programming and Reset for Installation Type 5.....	20
Module Reset.....	21
Feature and Option List.....	22
Feature Programming.....	22
LED Diagnostics and Troubleshooting.....	23
Optional RF Kits.....	24
Using a DBALL-CHRYSLER RSR.....	26
Limited One-Year Consumer Warranty.....	27



SmartStart Compatible

See page 2 for more information.

† Chrysler, Dodge, Jeep and Volkswagen are registered trademarks and property of their respective companies.

Important Information

3x OEM Lock Remote Start Activation

This feature enables you to start/stop the vehicle using the OEM remote.

Press the OEM remote LOCK button three (3) times within three (3) seconds to start the vehicle. To stop the vehicle, press the LOCK button three (3) more times.

 The OEM remote lock and unlock functions are inactive when the key is inserted into the ignition; therefore, the 3x OEM Lock Remote Start Activation feature cannot be used for idle mode.

SmartStart Compatible

Important!



SmartStart 200/250 **Revision B** is equipped with D2D, which means it can be connected to an interface module and used in Remote Start Ready (RSR) mode without the use of a remote starter.

In order to use the SmartStart 200/250 **Revision B** with an interface, you must enable the D2D mode within SmartStart by grounding the loose gray wire coming out of the device, as well as connecting it to the web to complete its configuration.

Vehicle Application Guide

Vehicles	2012	2011	2010	2009	2008	2007	2006	2005	2004	AV-Parking Lights Control	DL-Arm Factory Security	DL-Disarm Factory Security	DL-Door Lock Control	DL-Door Unlock	DL-Driver Priority Unlock	DL-Sliding Door Control Driver	DL-Sliding Door Control Passenger	DL-Trunk / Hatch Release	FOB-Control of aftermarket alarm with OEM remote	KI-Chrysler MUX Activation	KI-Key & Ignition switch Interface	PK-Immobilizer Bypass-Data No Key Read	RS 3x LOCK START (Start control using OEM Remote)	RS-RAP Shut Down (Remote ACC Power)	RS-Remote Start Ready Ign-RFTD	RS-Remote Start Ready Std Ign-RFTD	RS-Smart Start	RS-Tach / RPM Output	SS-Entry / Monitoring ALL Door Pins	SS-Entry / Monitoring Driver Door Pin	SS-Entry / Monitoring Trunk/Hatch Pin	ST-Brake Status (foot brake)	ST-Hand Brake Status	ST-Ignition Status	ST-Keysense Status			
Chrysler																																						
200		3																																				
300/300c			2	2	2																																	
300/300c						4	4	4																														
Aspen				3	3	3																																
Pacifica				5	5	5	5	5	5																													
PT Cruiser			4	4	4	4	4																															
Sebring			3	3	3	3																																
Sebring Convertible			3	3	3																																	
Sebring Sedan			3	3	3	3																																
Town & Country	1	1	1	1	1																																	
Town & Country						5	5	5	5																													
Dodge	12	11	10	09	08	07	06	05	04																													
Avenger		3	3	3	3																																	
Caliber		3	3	3	3	3*	3* or 4*	3*	3*																													
Caravan	1	1	1	1	1																																	
Caravan						5	5	5	5																													
Challenger		1	1	1	1																																	
Challenger (Smart Key)		1	1	1	1																																	
Charger		2	2	2																																		
Charger						4	4																															
Dakota		3	3	3	3	3																																
Durango		1																																				
Durango				3	3	3																																
Grand Caravan	1	1	1	1	1																																	
Grand Caravan						5	5	5	5																													
Journey			1	1																																		
Magnum					2																																	
Magnum						4	4	4																														
Nitro		3	3	3	3	3																																
RAM	1	1	1	1	1																																	
RAM						3	3	3*	3* or 4*																													
Jeep	12	11	10	09	08	07	06	05	04																													
Commander			2	2	2																																	
Commander						4	4																															
Compass		3	3	3	3	3																																
Grand Cherokee		1																																				
Grand Cherokee			2	2	2																																	
Grand Cherokee						4	4	4																														
Grand Cherokee (Smart Key)		1																																				
Liberty		3	3	3	3	3																																
Patriot		3	3	3	3	3	3																															
Wrangler		3	3	3	3	3	3																															
Wrangler Unlimited		3	3	3	3	3	3																															
Mitsubishi	12	11	10	09	08	07	06	05	04																													
Raider				3	3	3																																
Ram	12	11	10	09	08	07	06	05	04																													
1500		1																																				
2500		1																																				
3500		1																																				
C/V		1																																				
Volkswagen	12	11	10	09	08	07	06	05	04																													
Routan	1	1	1	1	1																																	

*To select the proper install type, locate the ignition switch connector and select your install type as illustrated below:

Installation Type 3 does not have a Start wire

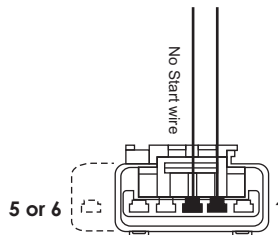

Connector side view at ignition switch

Installation Type 4 has a Start wire

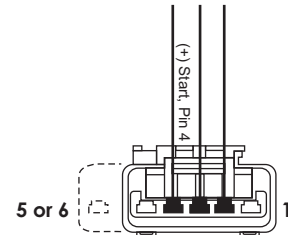

Connector side view at ignition switch

Installation Type 1a (with T-Harness)

Important! The Hood Pin and Neutral Safety Switch are mandatory security devices, but are NOT supplied with the DBALL.

The **optional** XL202 and antenna are not included and **MUST** be purchased separately.

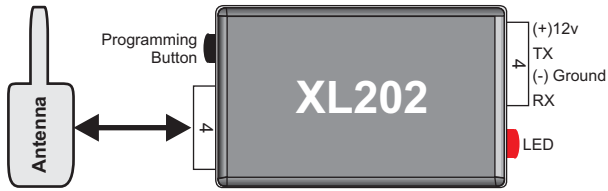

SmartStart is **optional** and not included. It **MUST** be purchased separately.

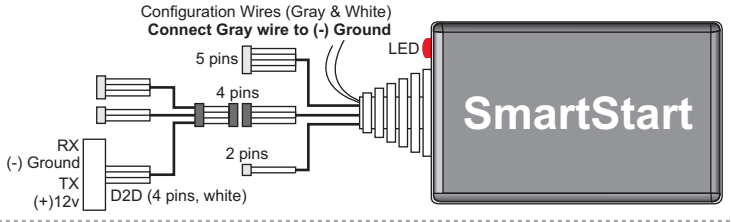

You can either connect to an XL202 module or to a SmartStart module.

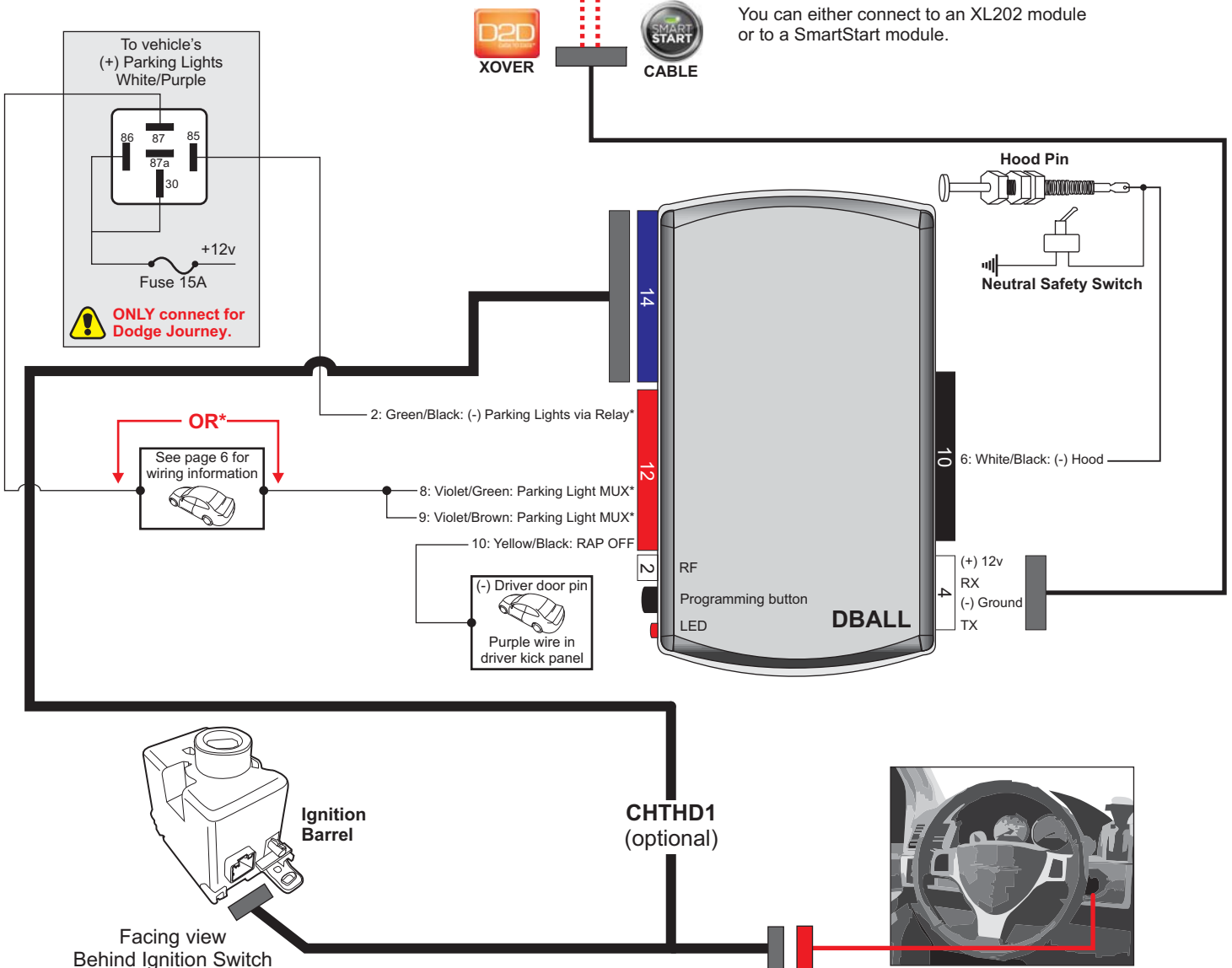

! Wires are listed by pin numbers. This display is not representative of connector pin layouts, which are often stacked.

*See Parking Lights wiring reference chart for the appropriate Parking Lights configuration.

Installation Type 1b (without T-Harness)

Important! The Hood Pin and Neutral Safety Switch are mandatory security devices, but are NOT supplied with the DBALL.

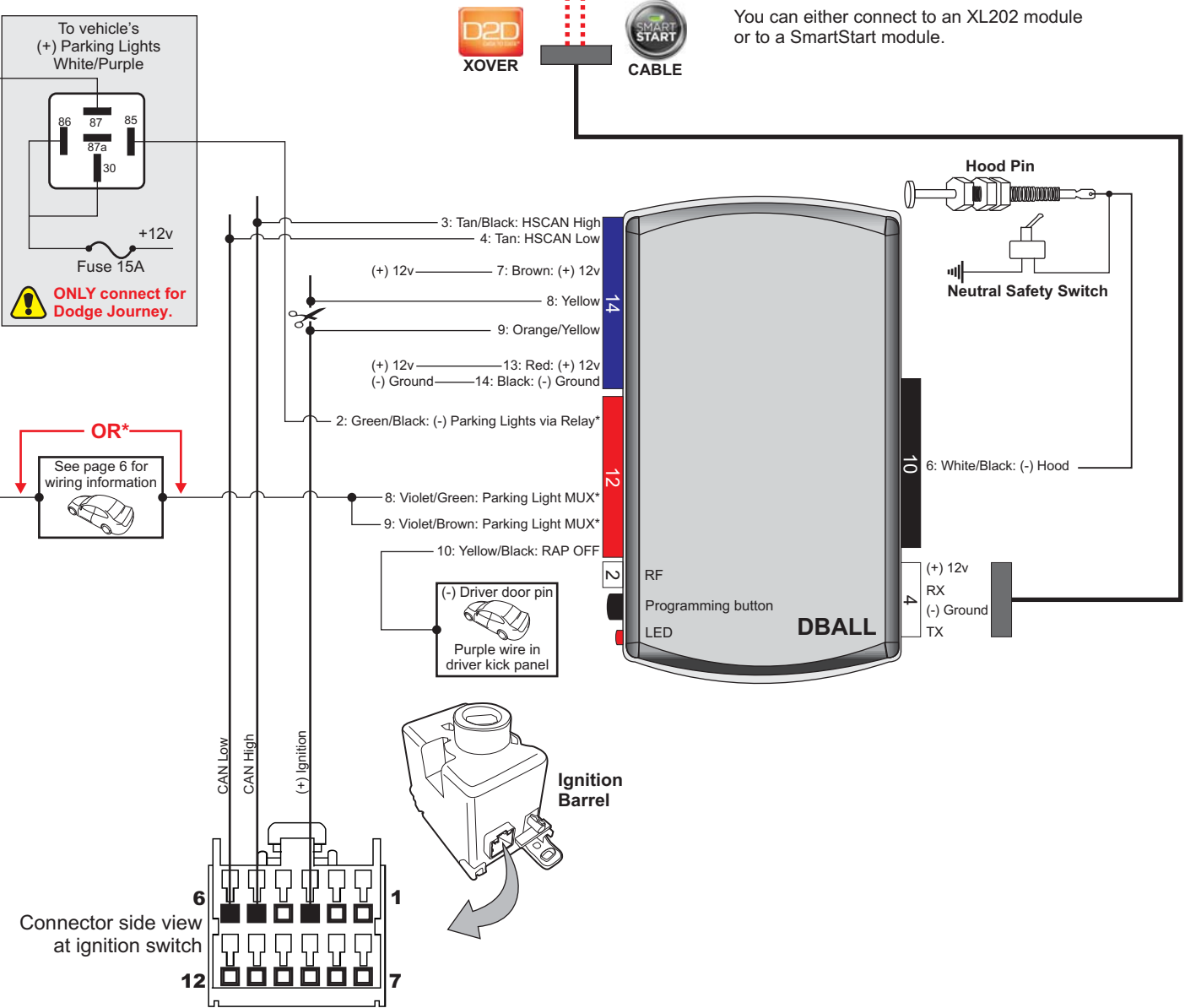
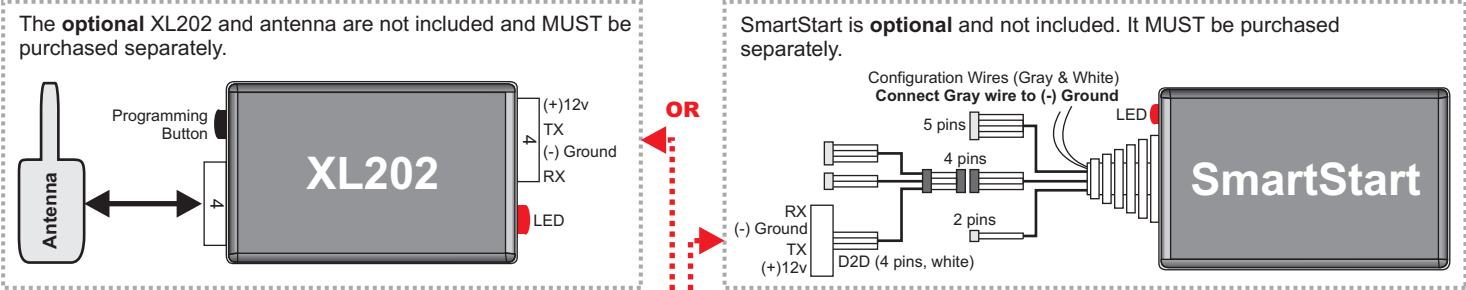

! Wires are listed by pin numbers. This display is not representative of connector pin layouts, which are often stacked.
 *See Parking Lights wiring reference chart for the appropriate Parking Lights configuration.

Parking Light Vehicle Wiring Reference Chart (Type 1)

Vehicle	Years	Vehicle Wire	Location on vehicle	(+) / (-)	DBALL Output from 12 Pin connector
Chrysler					
Town & Country	2011+	White/Green	Black connector at light switch, pin 3	MUX	8: Violet/Green: Parking Light MUX 9: Violet/Brown: Parking Light MUX
Town & Country	2008-10	White/Brown	Black connector at light switch, pin 1	MUX	8: Violet/Green: Parking Light MUX 9: Violet/Brown: Parking Light MUX
Dodge					
Caravan	2011+	White/Green	Black connector at light switch, pin 3	MUX	8: Violet/Green: Parking Light MUX 9: Violet/Brown: Parking Light MUX
Caravan	2008-10	White/Brown	Black connector at light switch, pin 1	MUX	8: Violet/Green: Parking Light MUX 9: Violet/Brown: Parking Light MUX
Challenger	2008-11	White/Brown	Black connector at light switch, pin 1	MUX	8: Violet/Green: Parking Light MUX 9: Violet/Brown: Parking Light MUX
Challenger (Smart Key)	2008-11	White/Brown	Black connector at light switch, pin 1	MUX	8: Violet/Green: Parking Light MUX 9: Violet/Brown: Parking Light MUX
Durango	2011+	White/Green	Black connector at light switch, pin 3	MUX	8: Violet/Green: Parking Light MUX 9: Violet/Brown: Parking Light MUX
Grand Caravan	2011+	White/Green	Black connector at light switch, pin 3	MUX	8: Violet/Green: Parking Light MUX 9: Violet/Brown: Parking Light MUX
Grand Caravan	2008-10	White/Brown	Black connector at light switch, pin 1	MUX	8: Violet/Green: Parking Light MUX 9: Violet/Brown: Parking Light MUX
Journey	2009-10	White/Purple	Passenger kick panel	(+)	2: Green/Black: (-) Parking Lights via Relay
RAM	2009-12	White	Black connector at light switch, pin 1	MUX	8: Violet/Green: Parking Light MUX 9: Violet/Brown: Parking Light MUX
Jeep					
Grand Cherokee	2011+	White/Green	Black connector at light switch, pin 1	MUX	8: Violet/Green: Parking Light MUX 9: Violet/Brown: Parking Light MUX
Grand Cherokee (Smart Key)	2011+	White/Green	Black connector at light switch, pin 1	MUX	8: Violet/Green: Parking Light MUX 9: Violet/Brown: Parking Light MUX
Ram					
1500	2012	White	Black connector at light switch, pin 1	MUX	8: Violet/Green: Parking Light MUX 9: Violet/Brown: Parking Light MUX
2500	2012	White	Black connector at light switch, pin 1	MUX	8: Violet/Green: Parking Light MUX 9: Violet/Brown: Parking Light MUX
3500	2012	White	Black connector at light switch, pin 1	MUX	8: Violet/Green: Parking Light MUX 9: Violet/Brown: Parking Light MUX
C/V	2012	White	Black connector at light switch, pin 1	MUX	8: Violet/Green: Parking Light MUX 9: Violet/Brown: Parking Light MUX
Volkswagen					
Routan	2011+	White/Green	Black connector at light switch, pin 3	MUX	8: Violet/Green: Parking Light MUX 9: Violet/Brown: Parking Light MUX
Routan	2009-10	White/Brown	Black connector at light switch, pin 1	MUX	8: Violet/Green: Parking Light MUX 9: Violet/Brown: Parking Light MUX

Light switch, black 10-pin plug

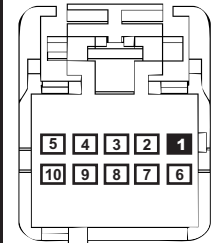

Light switch, black 6-pin plug

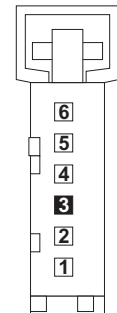

Installation Type 2a (with T-Harness)

Important! The Hood Pin and Neutral Safety Switch are mandatory security devices, but are NOT supplied with the DBALL.

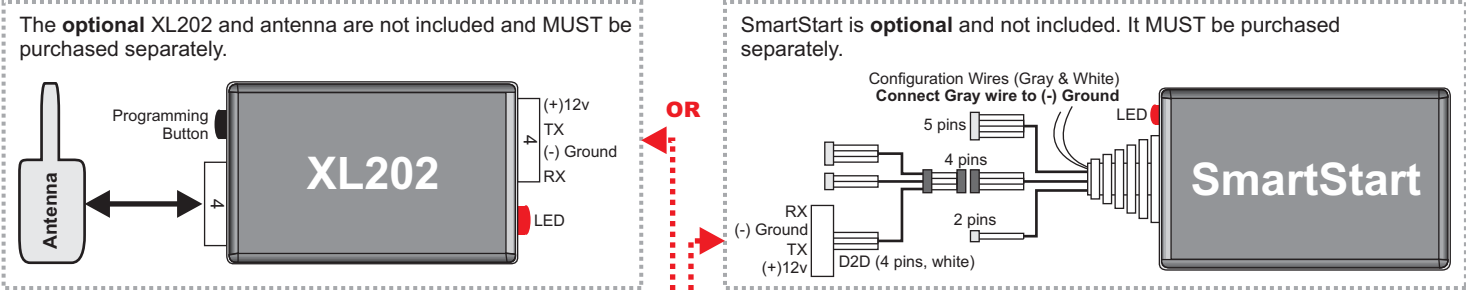

You can either connect to an XL202 module or to a SmartStart module.

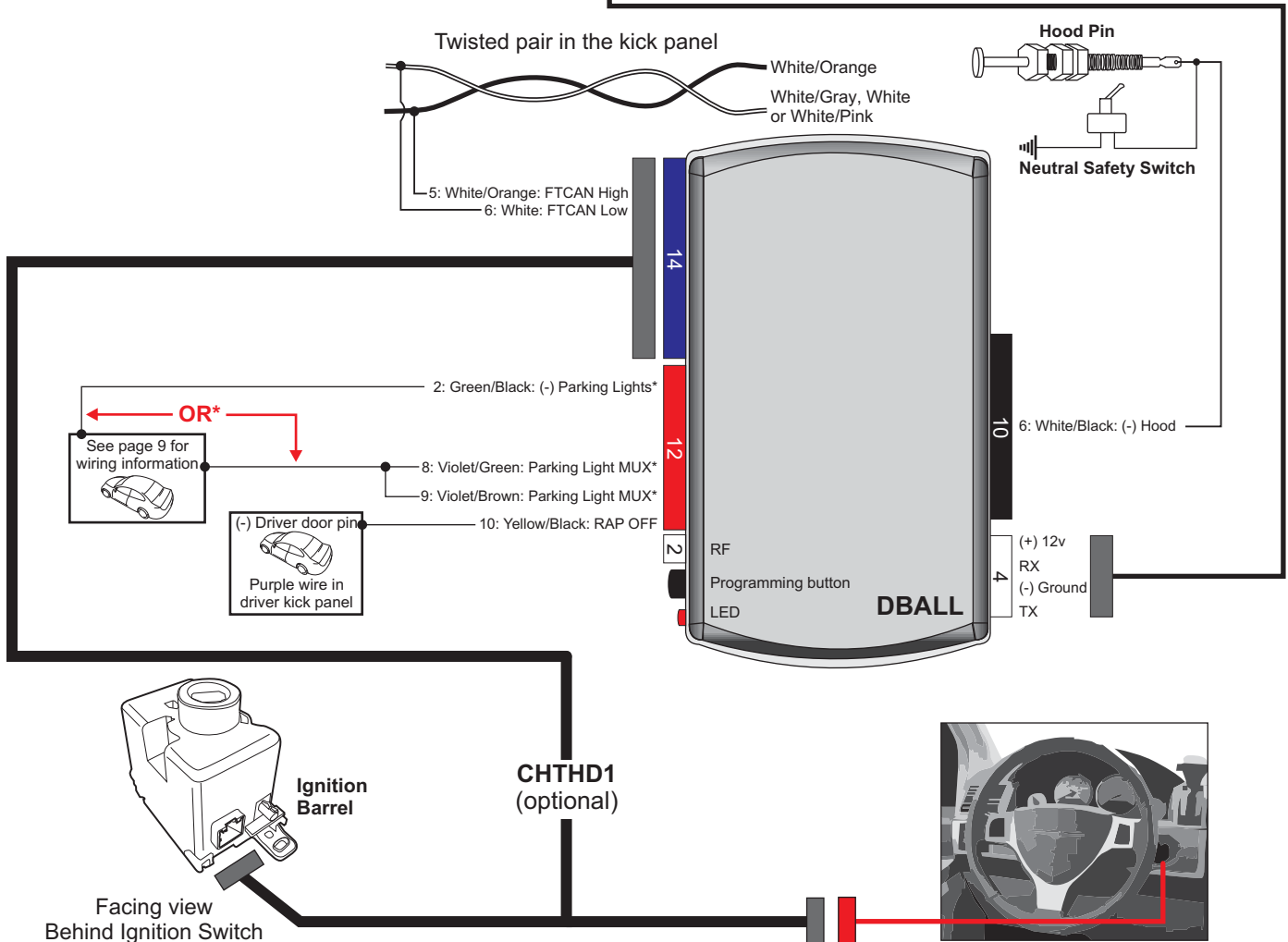

! Wires are listed by pin numbers. This display is not representative of connector pin layouts, which are often stacked.
 *See Parking Lights wiring reference chart for the appropriate Parking Lights configuration.

Installation Type 2b (without T-Harness)

Important! The Hood Pin and Neutral Safety Switch are mandatory security devices, but are NOT supplied with the DBALL.

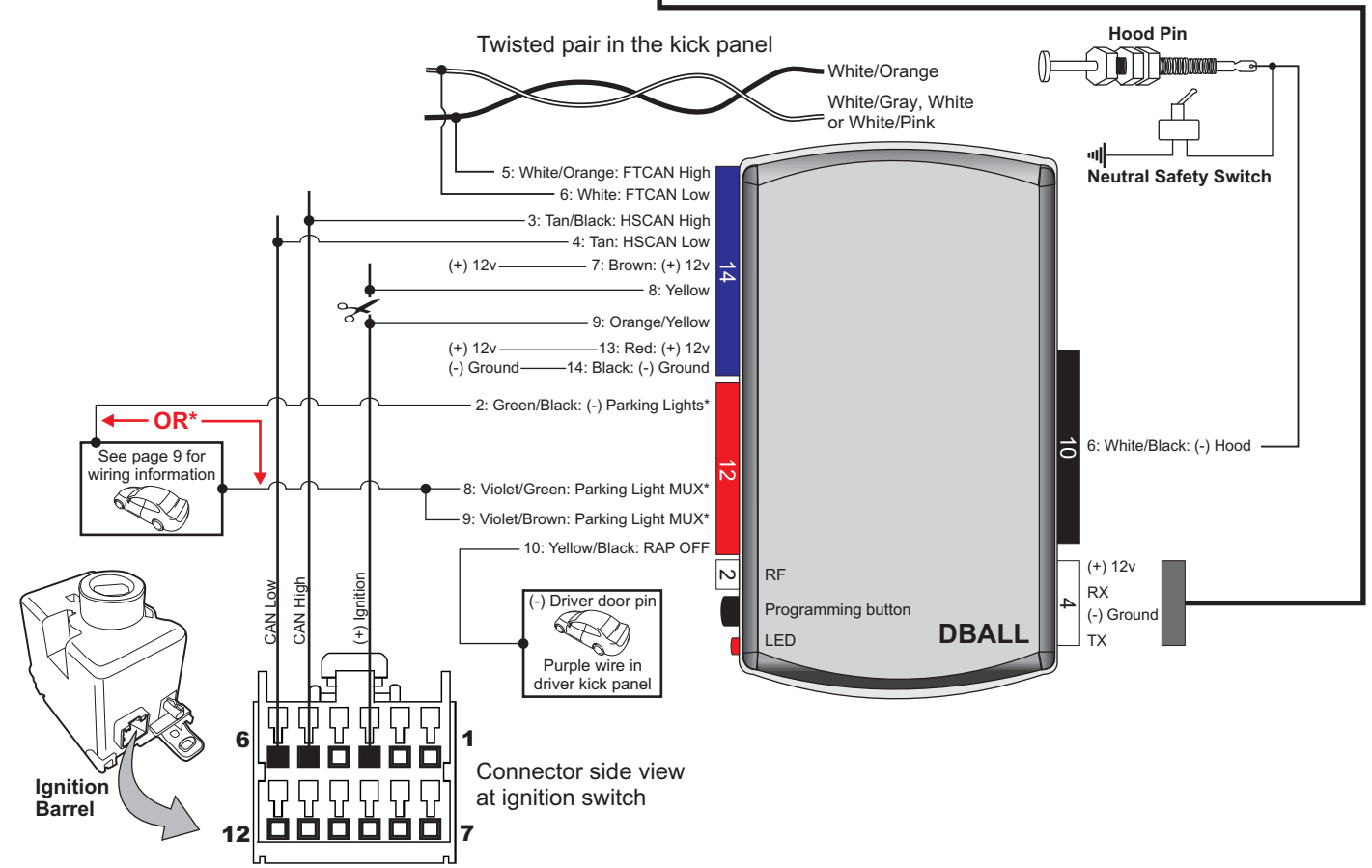
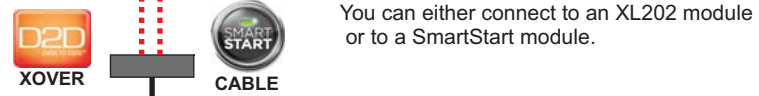
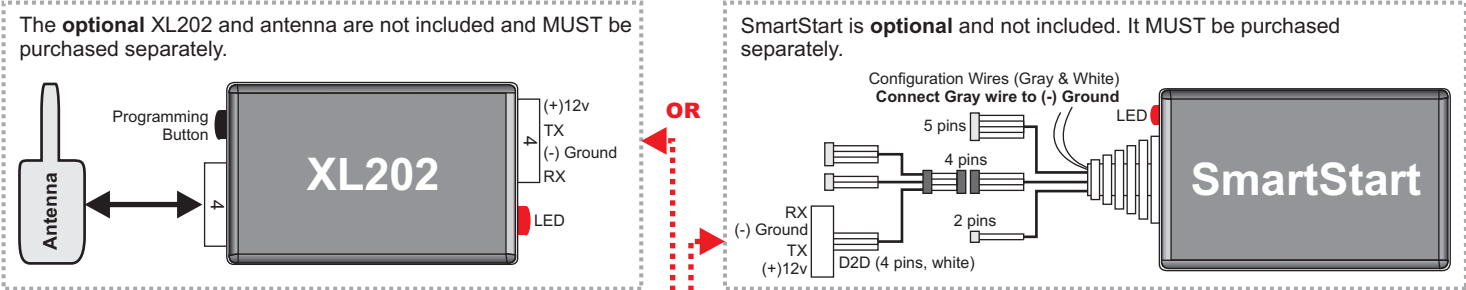

! Wires are listed by pin numbers. This display is not representative of connector pin layouts, which are often stacked.
 *See Parking Lights wiring reference chart for the appropriate Parking Lights configuration.

Parking Light Vehicle Wiring Reference Chart (Type 2)

Vehicle	Years	Vehicle Wire	Location on vehicle	(+) / (-)	DBALL Output from 12 Pin connector
Chrysler					
300/300c	2008-10	White/Brown	Black connector at light switch, pin 1	MUX	8: Violet/Green: Parking Light MUX 9: Violet/Brown: Parking Light MUX
Dodge					
Charger	2008-10	White/Brown	Black connector at light switch, pin 1	MUX	8: Violet/Green: Parking Light MUX 9: Violet/Brown: Parking Light MUX
Magnum	2008	White/Brown	Black connector at light switch, pin 1	MUX	8: Violet/Green: Parking Light MUX 9: Violet/Brown: Parking Light MUX
Jeep					
Commander	2008-10	White/Dk. Blue	Hazar light switch	(-)	2: Green/Black: (-) Parking Lights
Grand Cherokee	2008-10	White/Dk. Blue	Hazar light switch	(-)	2: Green/Black: (-) Parking Lights

Light switch, black 10-pin plug

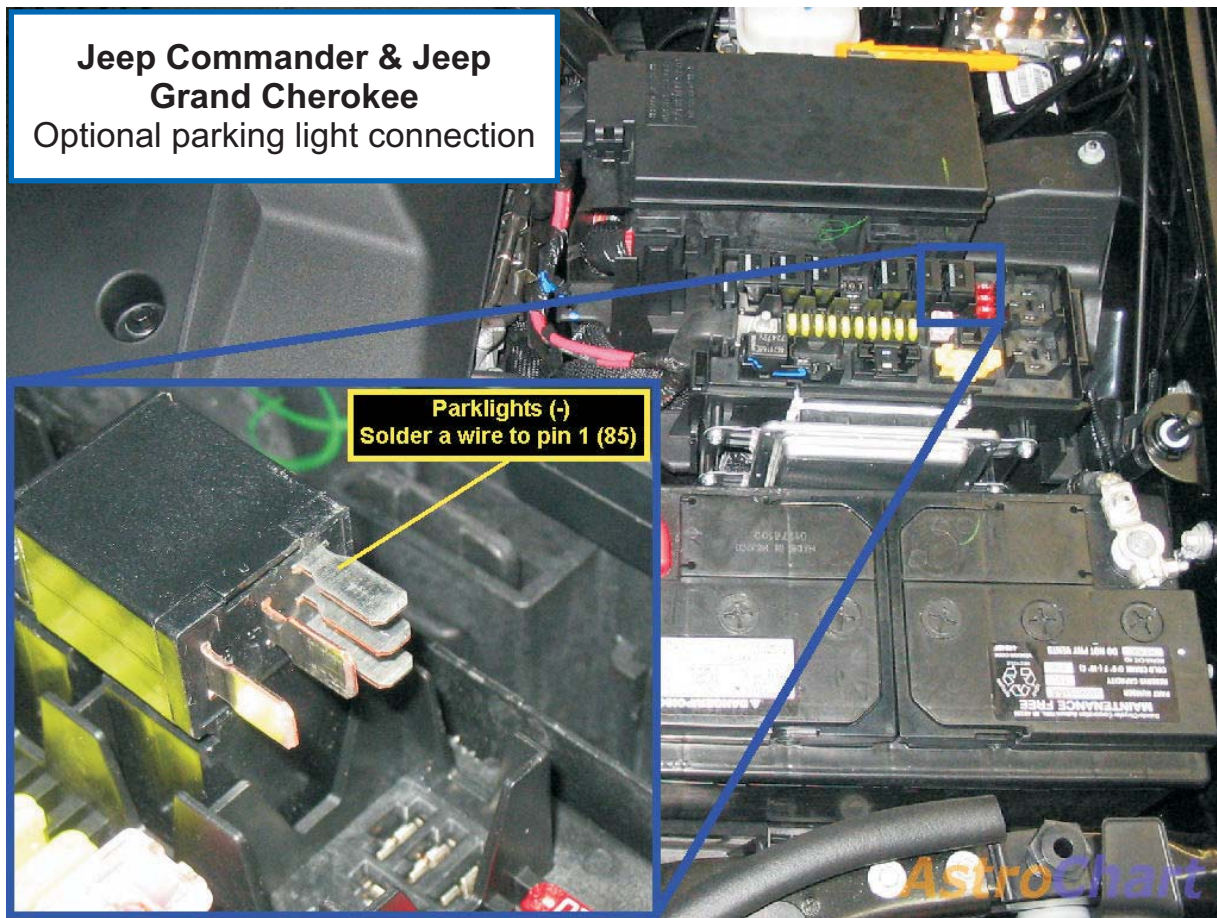
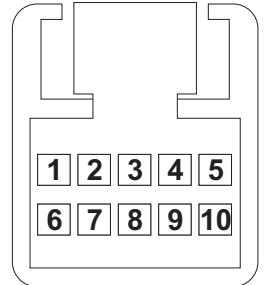

Installation Type 3a (with T-Harness)

Important! The Hood Pin and Neutral Safety Switch are mandatory security devices, but are NOT supplied with the DBALL.

The optional XL202 and antenna are not included and MUST be purchased separately.



SmartStart is optional and not included. It MUST be purchased separately.

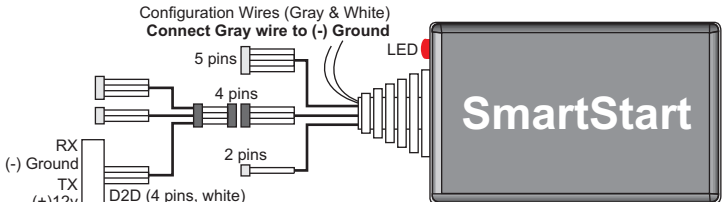

You can either connect to an XL202 module or to a SmartStart module.

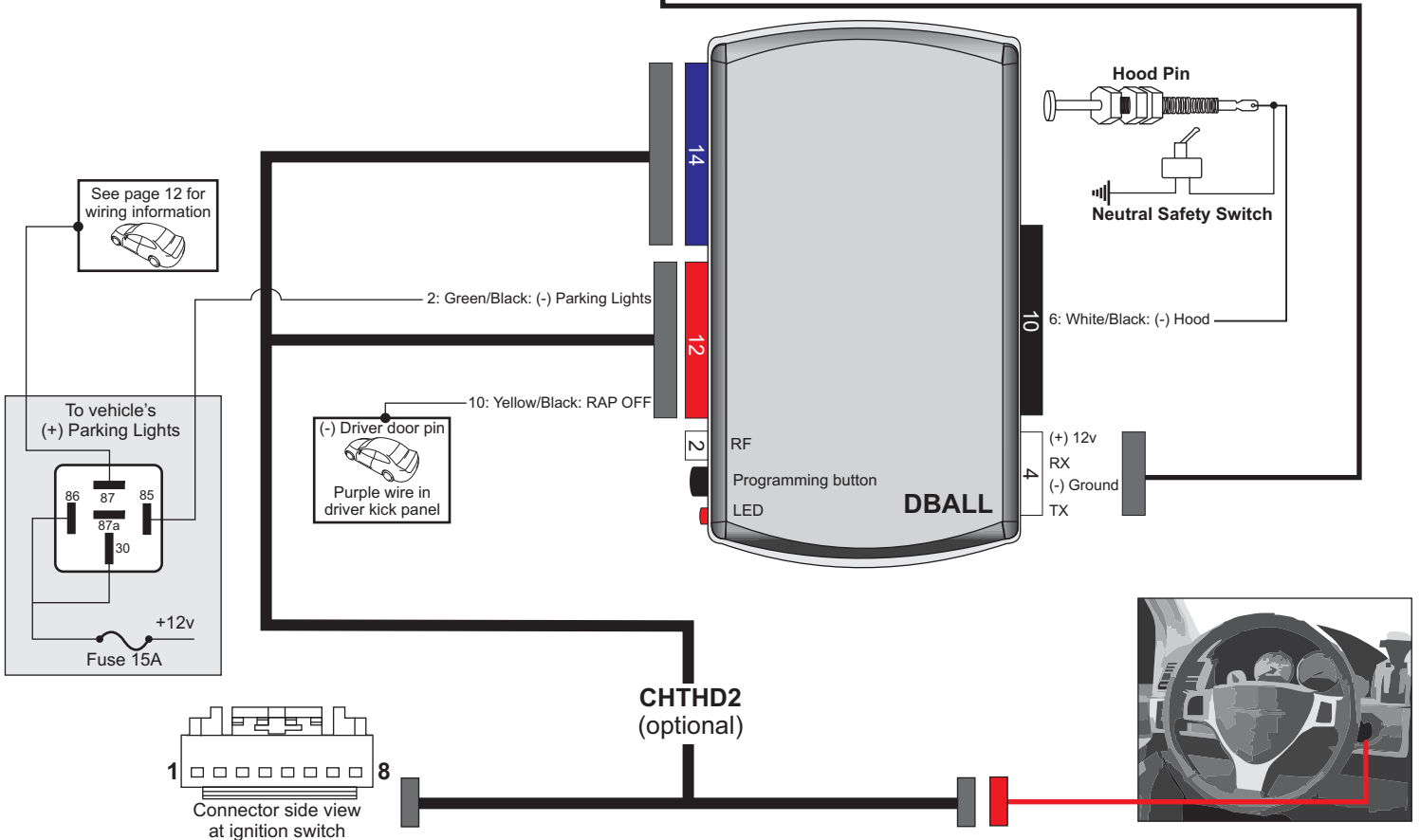

Warning! Wires are listed by pin numbers. This display is not representative of connector pin layouts, which are often stacked.

Installation Type 3b (without T-Harness)

Important! The Hood Pin and Neutral Safety Switch are mandatory security devices, but are NOT supplied with the DBALL.

The optional XL202 and antenna are not included and MUST be purchased separately.

SmartStart is optional and not included. It MUST be purchased separately.

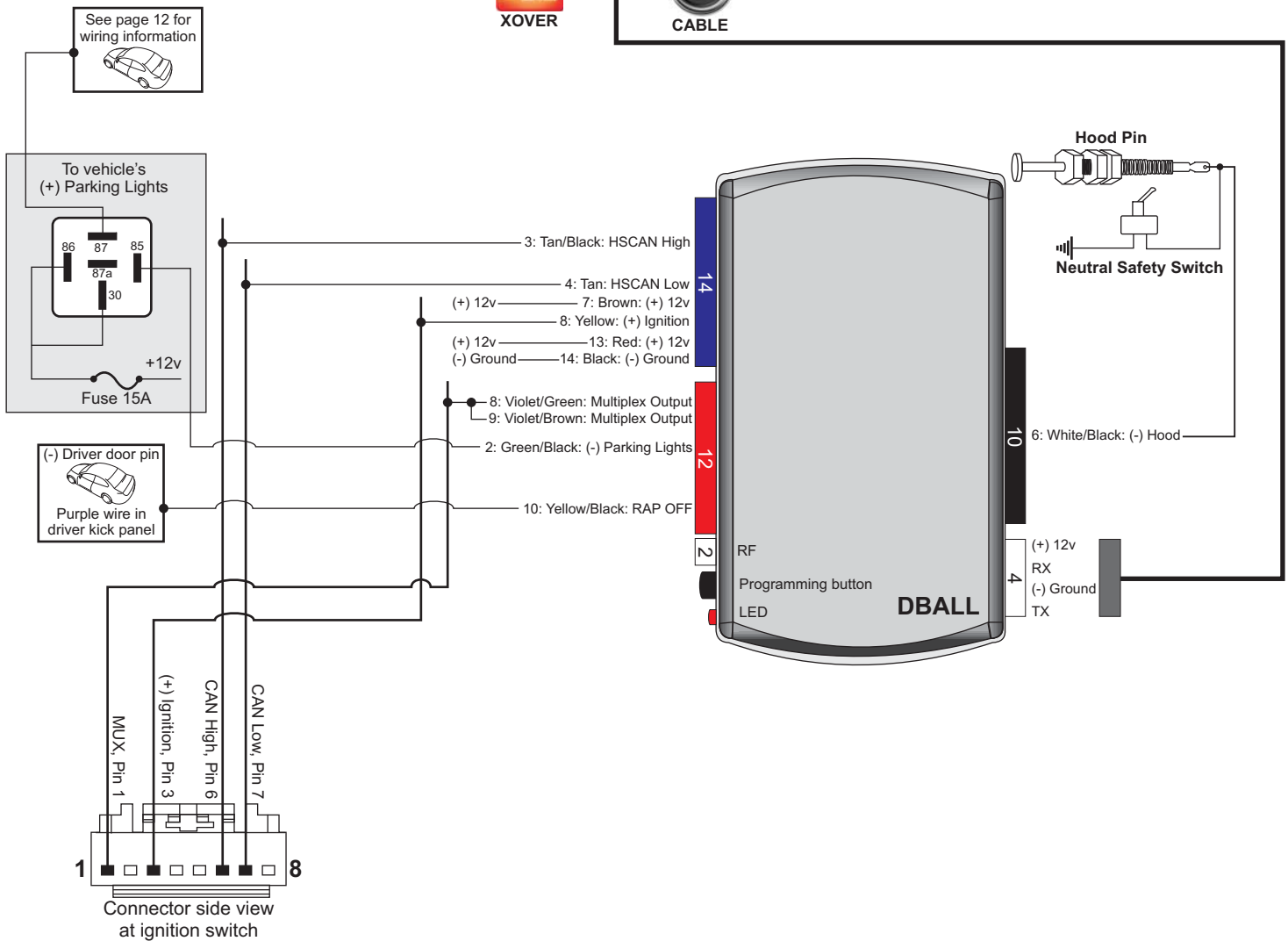
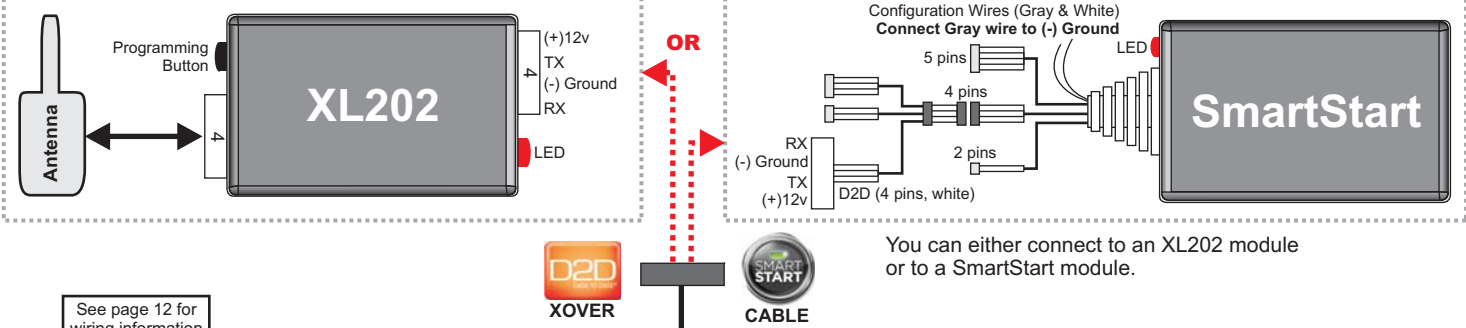

! Wires are listed by pin numbers. This display is not representative of connector pin layouts, which are often stacked.

Parking Light Vehicle Wiring Reference Chart (Type 3)

Vehicle	Years	Wire	(+) / (-)	Location
Chrysler				
200	2011	White/Violet	(+)	Driver kick panel
Aspen	2007-09	Pink/Red	(+)	Driver kick fuse box, black 40-pin plug
Sebring	2007-10	White/Violet	(+)	Driver kick panel
Sebring Convertible	2008-10	White/Violet	(+)	Driver kick panel
Sebring Sedan	2007-10	White/Violet	(+)	Driver kick panel
Dodge				
Avenger	2008-11	White/Violet	(+)	Driver kick panel
Caliber	2007-11	White/Violet	(+)	Driver kick panel
Dakota	2007-11	Pink/Red	(+)	Underhood fuse box, black 20-pin plug
Durango	2007-09	Pink/Red	(+)	Driver kick fuse box, black 40-pin plug
Nitro	2007-11	White/Violet	(+)	Driver kick panel
RAM	2006-08	White/Gray	(+)	Above driver kick, gray 74-pin plug
Jeep				
Compass	2007-11	White/Violet	(+)	Driver kick panel
Liberty	2008-10	White/Violet	(+)	Driver kick panel
Patriot	2007-12	White/Violet	(+)	Driver kick panel
Wrangler	2007-12	White/Violet	(+)	Passenger kick panel
Wrangler Limited	2007-12	White/Violet	(+)	Passenger kick panel
Mitsubishi				
Raider	2007-09	Pink/Red	(+)	Underhood fuse box, black 20-pin plug

Driver kick fuse box, black 40-pin plug

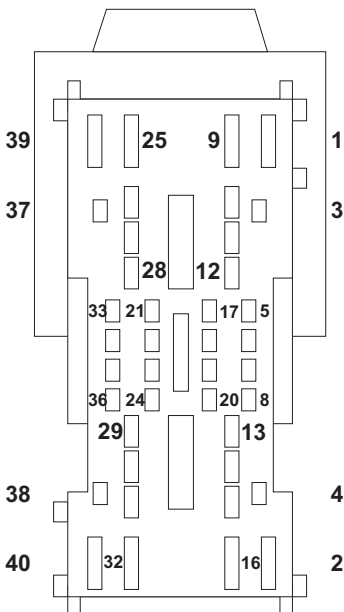

Underhood fuse box, black 20-pin plug

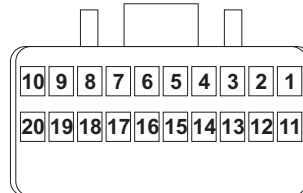

Above driver kick, gray 74-pin plug

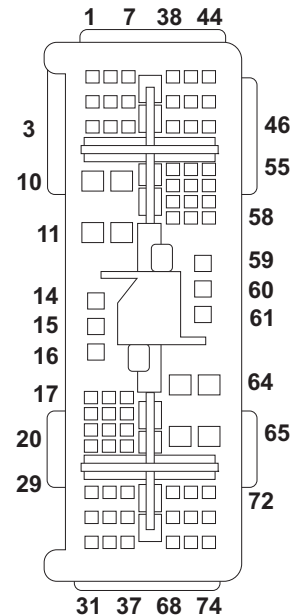

Installation Type 4a (with T-Harness)

Important! The Hood Pin and Neutral Safety Switch are mandatory security devices, but are NOT supplied with the DBALL.

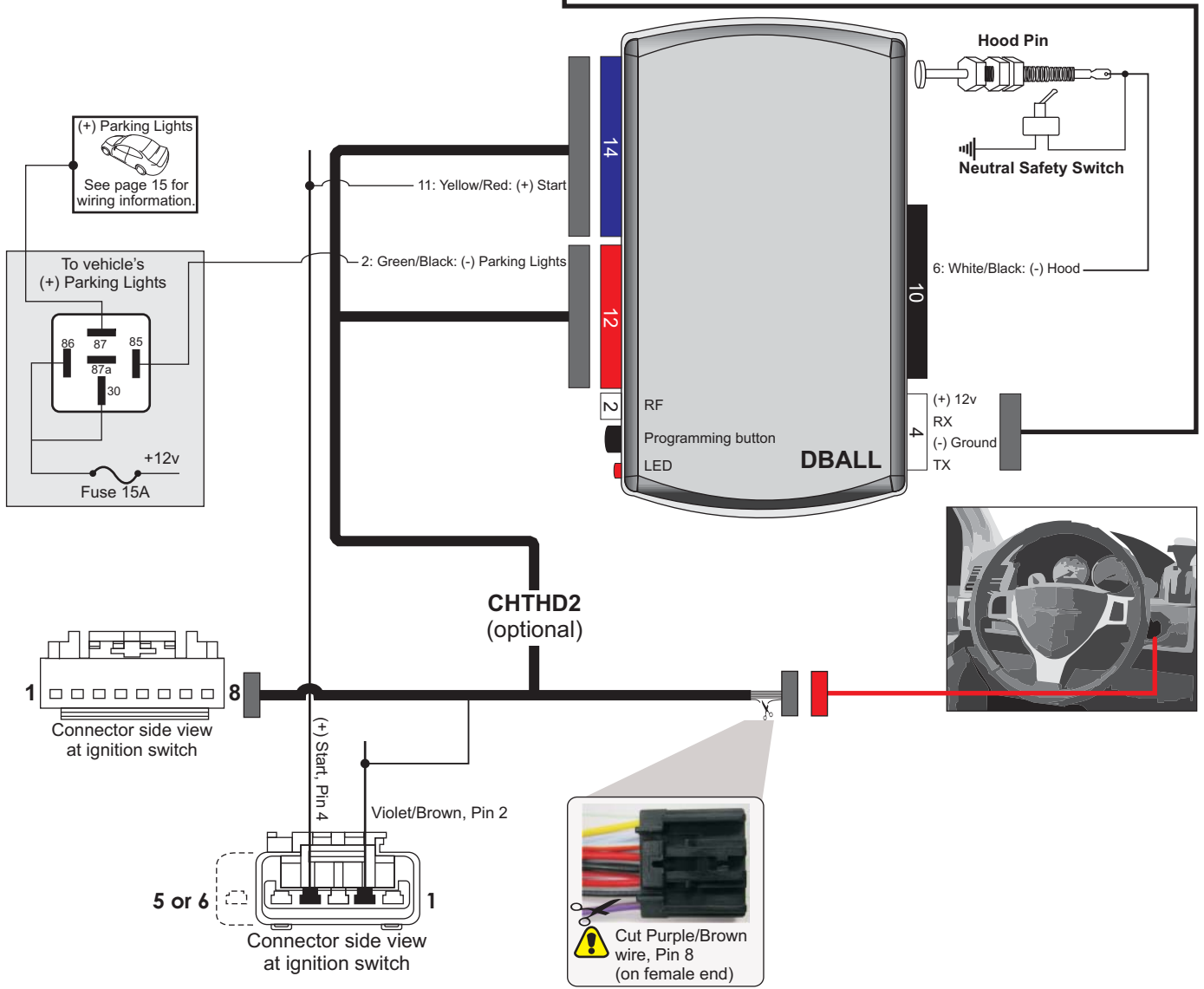
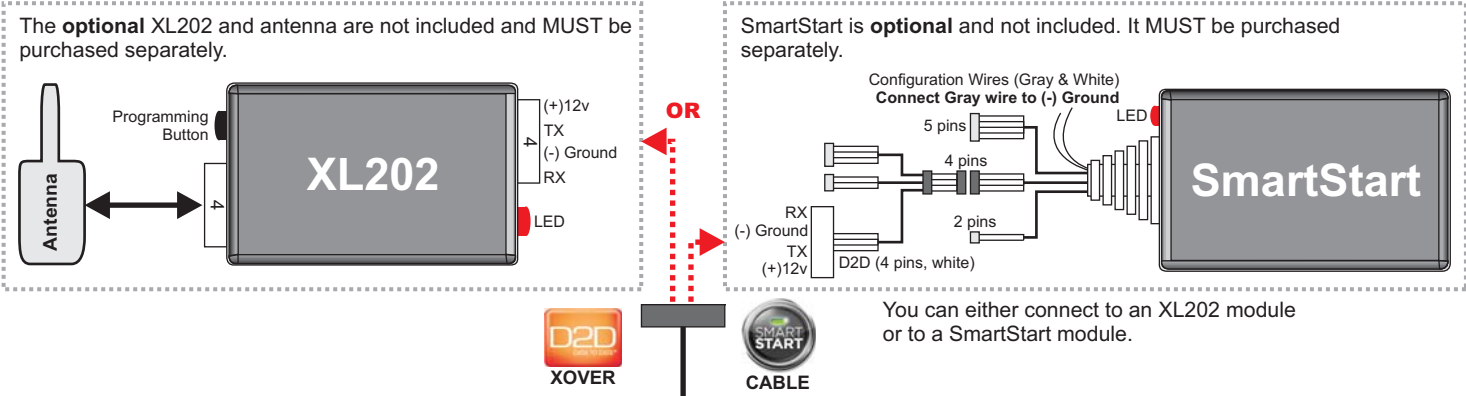

! Wires are listed by pin numbers. This display is not representative of connector pin layouts, which are often stacked.

Parking Light Vehicle Wiring Reference Chart (Type 4)

Vehicle	Years	Wire	(+) / (-)	Location
Chrysler				
300/300c	2005-07	White/Violet	(+)	Passenger kick panel
PT Cruiser	2006-10	White/Violet	(+)	Driver kick panel
Dodge				
Caliber	2007-11	White/Violet	(+)	Driver kick panel
Charger	2006-07	White/Violet	(+)	Passenger kick panel
Magnum	2005-07	White/Violet	(+)	Passenger kick panel
RAM	2006	White/Gray	(+)	Above driver kick, gray 74-pin plug
Jeep				
Commander	2006-07	White/Dk. Blue	(-)	Hazard light switch
Grand Cherokee	2005-07	White/Dk. Blue	(-)	Hazard light switch

Above driver kick,
 gray 74-pin plug

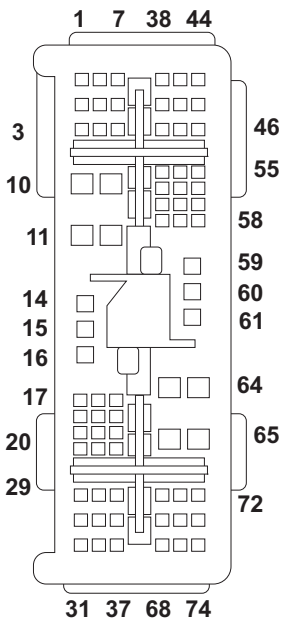

Installation Type 5 (without T-Harness)

Important! The Hood Pin and Neutral Safety Switch are mandatory security devices, but are NOT supplied with the DBALL.

The optional XL202 and antenna are not included and MUST be purchased separately.

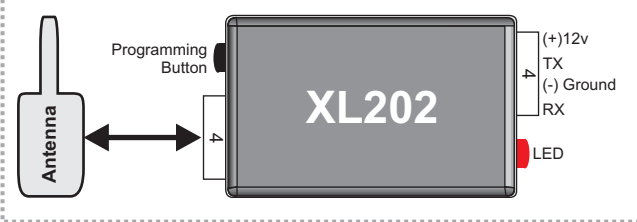

SmartStart is optional and not included. It MUST be purchased separately.

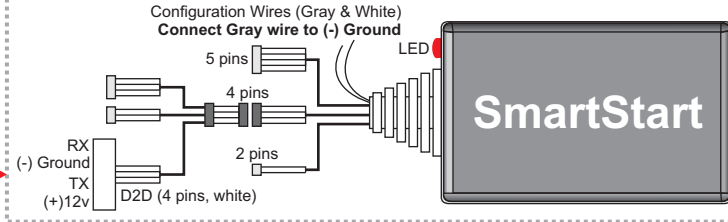

You can either connect to an XL202 module or to a SmartStart module.

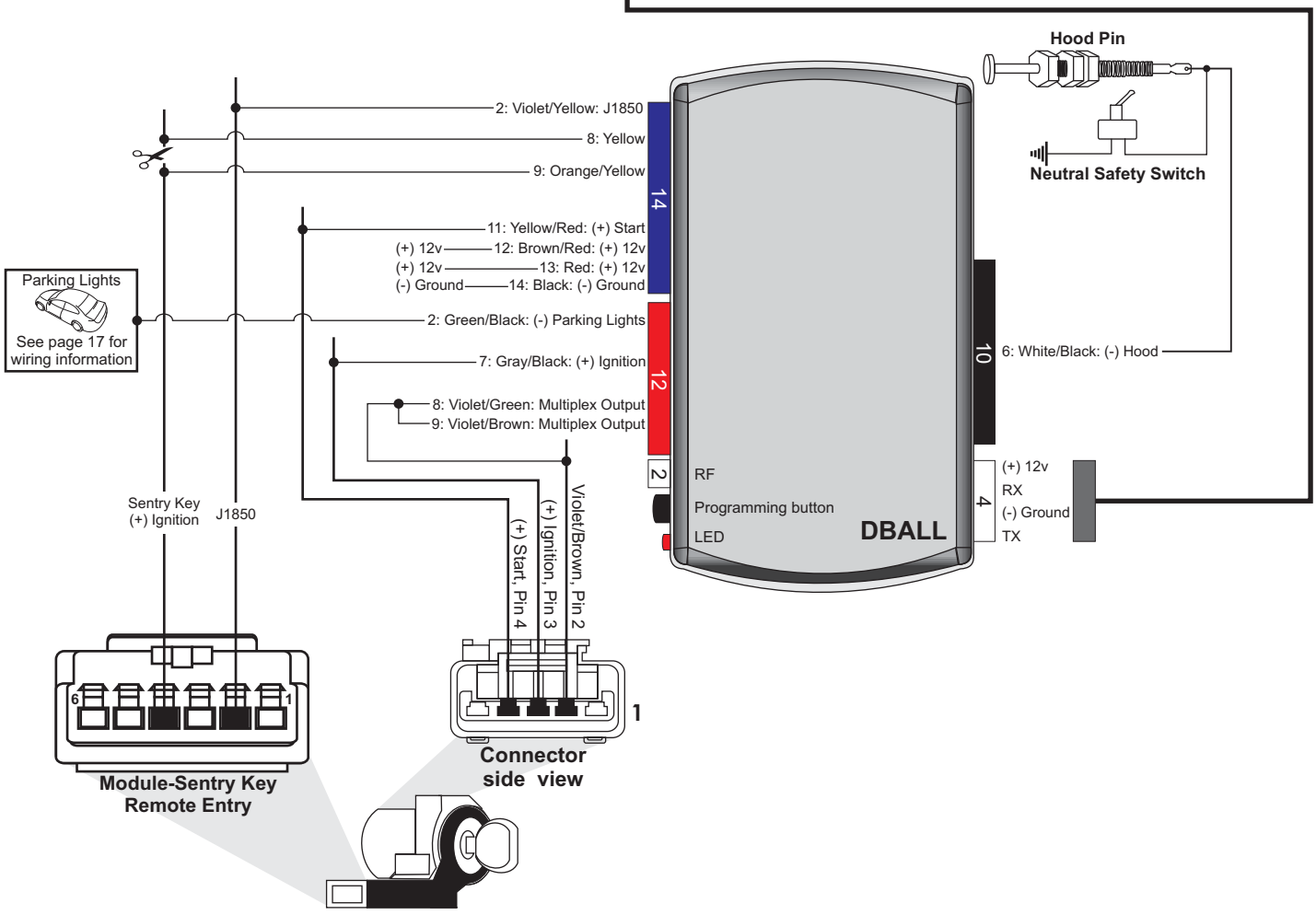

! Wires are listed by pin numbers. This display is not representative of connector pin layouts, which are often stacked.

Parking Light Vehicle Wiring Reference Chart (Type 5)

Vehicle	Years	Wire	(+) / (-)	Location
Chrysler				
Pacifica	2004-08	Brown/White (-1K)	MUX	Headlight switch, black 12-pin plug, pin 6
Town & Country	2004-07	White/Orange	(+)	Driver kick panel
Dodge				
Caravan	2004-07	White/Orange	(+)	Driver kick panel
Grand Caravan	2004-07	White/Orange	(+)	Driver kick panel

Headlight switch, black 12-pin plug

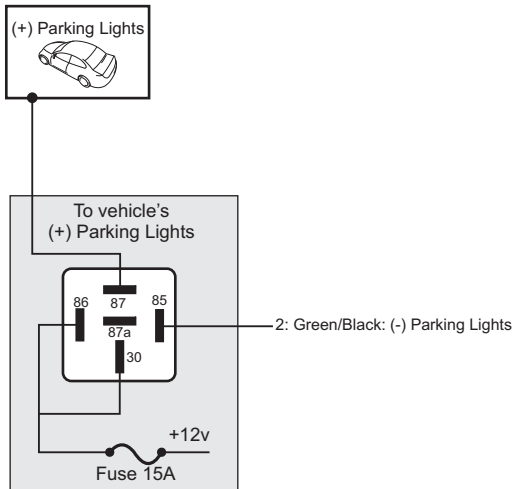
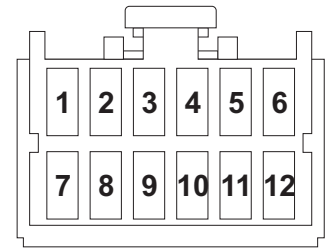

OR

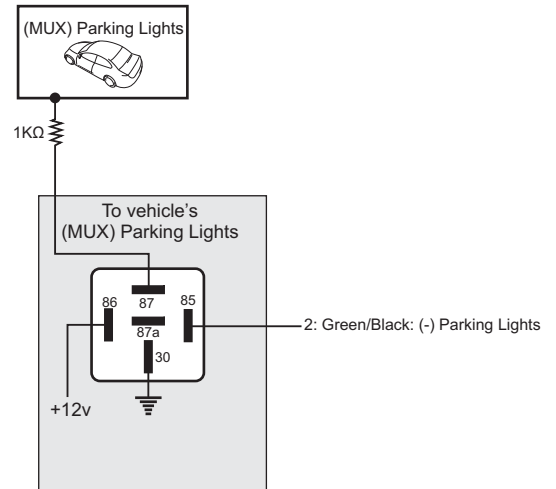

Positive (+)

MUX

Module Programming for Installation Types 1 to 4 (WITH Factory Keyless)

 Refer to the LED Diagnostics section on page 23 for more information and for troubleshooting purposes.

Important

Make all the required connections to the vehicle, as described in the wiring diagram(s) found in this guide, and double check to ensure everything is correct prior to moving onto the next step.

Note: Before connecting either the XL202 or SmartStart module to DBALL, it is important to ensure that the proper communication protocol is enabled on DBALL using XpressVIP. This selection is done by:

1. Going to www.xpresskit.com.
2. Selecting the make, model and year of the vehicle.
3. On the search result page, click on the **Flash it** button.
4. The flash page will then be displayed listing the D2D type settings. Make your selection and flash the module.

To use DBALL with an:

- RF Kit and XL202, **D2D (RFTD)** must be selected.
- SmartStart (Revision B), **D2D (SmartStart)** must be selected.

Warning against resetting the DBALL module before executing the programming sequence!

A reset will erase all the settings configured on the module using the web tool (see the above instructions). Therefore, if you reset before executing the programming sequence, you will HAVE to re-flash the module in order to re-configure the desired options.

DBALL Module Programming

- 1** Connect the SmartStart or XL202 unit into the D2D port of the DBALL prior to connecting the power.

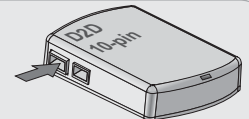

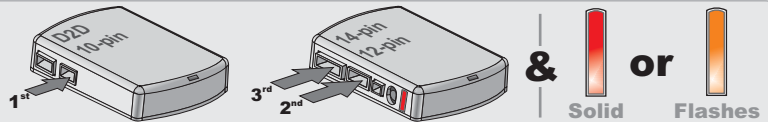

- 2** Connect the 10-pin, 12-pin and 14-pin harnesses to DBALL, then wait until the LED turns ON solid red or flashes orange.



- 3 Key Ignition**
 Insert the key into the ignition barrel and turn it to the ON position.
 It is important to wait for the LED to start flashing green. Refer to the LED Diagnostics section on page 23 for troubleshooting if the LED does not flash green within 15 seconds.



- 3 Push-to-Start (PTS) Ignition**
Important: Do NOT press the brake pedal.
 Press the Push-to-Start (PTS) button twice to turn the ignition ON.
-  Do NOT press the brake pedal
- 2X**  **PUSH**
- It is important to wait for the LED to start flashing green. Refer to the LED Diagnostics section on page 23 for troubleshooting if the LED does not flash green within 15 seconds.

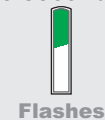

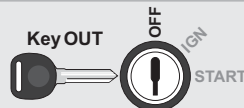

- 4** Turn the key to the OFF position and remove it from the ignition barrel.

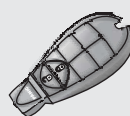

- 4** Press the Push-to-Start (PTS) button once more to turn the ignition OFF.
- 1X**  **PUSH**

- 5** Press LOCK or UNLOCK on the **factory transmitter**. The LED turns ON solid green OR orange for 3 seconds and then turns off.



 **Important!** If connected to a SmartStart, please ensure that its Gray wire is connected to a ground source or the D2D communication between the two (2) modules will NOT work.

Module Programming for Installation Types 1 to 4 (WITHOUT Factory Keyless)

 Refer to the LED Diagnostics section on page 23 for more information and for troubleshooting purposes.

Important

Make all the required connections to the vehicle, as described in the wiring diagram(s) found in this guide, and double check to ensure everything is correct prior to moving onto the next step.

Note: Before connecting either the XL202 or SmartStart module to DBALL, it is important to ensure that the proper communication protocol is enabled on DBALL using XpressVIP. This selection is done by:

1. Going to www.xpresskit.com.
2. Selecting the make, model and year of the vehicle.
3. On the search result page, click on the **Flash it** button.
4. The flash page will then be displayed listing the D2D type settings. Make your selection and flash the module.

To use DBALL with an:

- RF Kit and XL202, **D2D (RFTD)** must be selected.
- SmartStart (Revision B), **D2D (SmartStart)** must be selected.

 **Warning against resetting the DBALL module before executing the programming sequence!**

A reset will erase all the settings configured on the module using the web tool (see the above instructions). Therefore, if you reset before executing the programming sequence, you will HAVE to re-flash the module in order to re-configure the desired options.

DBALL Module Programming

- 1** Connect the SmartStart or XL202 unit into the D2D port of the DBALL prior to connecting the power.



- 2** Connect the 10-pin, 12-pin and 14-pin harnesses to DBALL, then wait until the LED turns ON solid red or flashes orange.

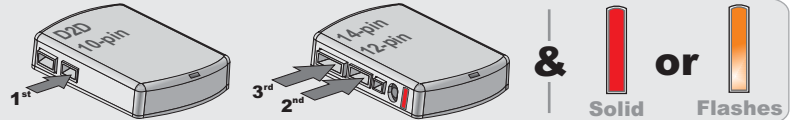

- 3** Insert the key into the ignition barrel and turn it to the ON position.

It is important to wait for the LED to start flashing green.*

* Refer to the LED Diagnostics section on page 23 for troubleshooting if the LED does not flash green within 15 seconds.



- 4** Press and hold the Programming Button. The LED turns ON solid green OR orange for 3 seconds and then turns OFF. Release the Programming button.



- 5** Turn the key to the OFF position and remove it from the ignition barrel.

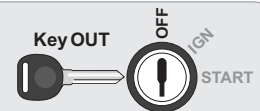

 **Important!** If connected to a SmartStart, please ensure that its Gray wire is connected to a ground source or the D2D communication between the two (2) modules will NOT work.

Module Programming for Installation Type 5

 Refer to the LED Diagnostics section on page 23 for more information and for troubleshooting purposes.

Important

Make all the required connections to the vehicle, as described in the wiring diagram(s) found in this guide, and double check to ensure everything is correct prior to moving onto the next step.

Note: Before connecting either the XL202 or SmartStart module to DBALL, it is important to ensure that the proper communication protocol is enabled on DBALL using XpressVIP. This selection is done by:

1. Going to www.xpresskit.com.
2. Selecting the make, model and year of the vehicle.
3. On the search result page, click on the **Flash it** button.
4. The flash page will then be displayed listing the D2D type settings. Make your selection and flash the module.

To use DBALL with an:

- RF Kit and XL202, **D2D (RFTD)** must be selected.
- SmartStart (Revision B), **D2D (SmartStart)** must be selected.

 **Warning against resetting the DBALL module before executing the programming sequence!**

A reset will erase all the settings configured on the module using the web tool (see the above instructions). Therefore, if you reset before executing the programming sequence, you will HAVE to re-flash the module in order to re-configure the desired options.

DBALL Module Programming

- 1** Connect the SmartStart or XL202 unit into the D2D port of the DBALL prior to connecting the power.

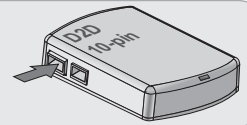

- 2** Connect the 10-pin, 12-pin and 14-pin harnesses to DBALL, then wait until the LED turns ON solid red.

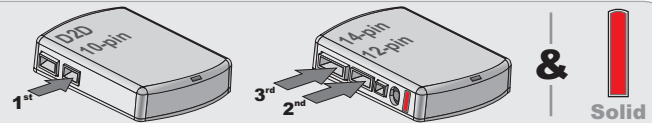

- 3** Insert the key into the ignition barrel without turning it and wait for the LED to flash orange.



- 4** Insert the key into the ignition barrel and turn it to the ON position. The LED will continue to flash orange. It will then turn ON solid green OR orange for 3 seconds, before turning OFF.

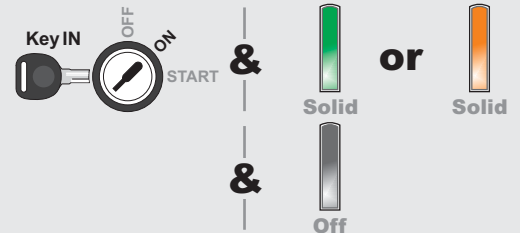

Refer to the LED Diagnostics section on page 23 for troubleshooting if the LED does not turn ON solid green OR orange within 15 seconds.

- 5** When the green LED turns OFF, turn the key to the OFF position and remove it from the ignition barrel.



 **Important!** If connected to a SmartStart, please ensure that its Gray wire is connected to a ground source or the D2D communication between the two (2) modules will NOT work.

DBALL Module Reset

 Refer to the LED Diagnostics section on page 23 for more information and for troubleshooting purposes.

Warning against resetting the DBALL module before executing the programming sequence!

A reset will erase all the settings configured on the module using the web tool (see the above instructions). Therefore, if you reset before executing the programming sequence, you will HAVE to re-flash the module in order to re-configure the desired options.

1a If using in D2D: Connect the 10-pin, 12-pin & 14-pin harnesses to the module. Press & hold the programming button, then connect the 4-pin D2D harness.

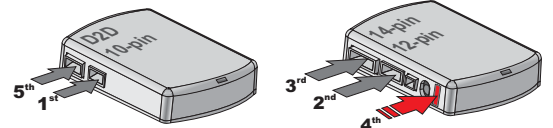

1b If using in W2W: Connect the 10-pin & 12-pin harnesses to the module. Press & hold the programming button, then connect the 14-pin harness to the module.

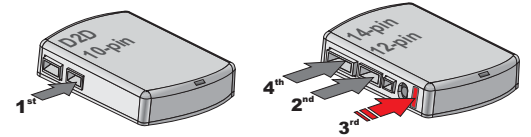

2 Wait until the LED turns ON orange then release the Programming button. The LED turns ON red.



Feature and Option List

 It is recommended to configure all features and options listed below on the **web** when the module is being flashed; however, a manual configuration is possible using the information found on this page.

Features	Operation	Option
1	RF Output Type** <i>Activate this feature whenever an external RFTD module is used (i.e. Directed SmartStart™, XL201 or XL202).</i>	No RF Output*
		RFTD Output
2	Trunk	No Option
		Trunk*
		Right Sliding Door
		Left Sliding Door
3	Aux1	No Option
		Trunk
		Passenger Sliding Door*
		Driver Sliding Door
4	Aux2	No Option
		Trunk
		Passenger Sliding Door
		Driver Sliding Door*



** Important

The RF Output Type function must be set to **RFTD Output** to enable the Remote Start Ready (RSR) mode. It will automatically be configured on the web when flashed with the selected **D2D_TYPE D2D (RFTD)** or **D2D (SmartStart)**.

Any module reset will reset to default option.

* Default option

Note: Features 2, 3 and 4 are programmable triggers.

Feature Programming

Programming Button

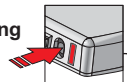

To enter feature programming routine

- Turn the ignition ON, then OFF.
- **Within 5 seconds**, press and HOLD the programming button until the LED turns ON orange (after 3 seconds). Release the Programming button.
- The LED will flash green once slowly to indicate the feature number is 1. After a short delay, the LED flashes red rapidly to indicate the current option of feature 1 (i.e. 1x green followed by 1x red indicates feature 1 is set to option 1). The flashing sequence will repeat until a new command is entered.

Changing feature options

- Press the lock/arm or unlock/disarm button on aftermarket transmitter to change the option of the selected feature.
- The LED flashes red rapidly the number of times equal to the current option number. After a short delay, the LED flashes green slowly the number of times to indicate the current feature. The flashing sequence will repeat until a new command is entered.

Accessing another feature

- Press and release the programming button a number of times to advance from the current feature to the next desired feature.
- The LED flashes green slowly the number of times equal to the feature number. After a short delay, the LED flashes red rapidly to indicate the current option of the current feature. The flashing sequence will repeat until a new command is entered.

When the maximum number of features or options is reached, the LED will start flashing again from the first feature or option.













Once a feature is programmed

- Other features can be programmed.
- The feature programming can be exited.

Exiting feature programming

- No activity for 30 seconds; after 30 seconds, the LED will turn ON orange for 2 seconds to confirm the end of the programming sequence.
OR
- Press and HOLD the programming button for 3 seconds. After 3 seconds, the LED will turn ON orange for 2 seconds to confirm the end of the programming sequence.

LED Diagnostics and Troubleshooting

LED	Status	Description	Troubleshooting
Module Programming			
 Off	Off	Module has no power.	Check the power connections.
 Solid	Solid red	The bus type cannot be detected.	Make sure the connections to the data bus are correct and insert the key in the ignition switch.
 Flashes	Flashes orange	The vehicle type cannot be detected.	Insert the key in the ignition switch and turn to the ON position. You may need to wait up to 10 seconds.
 Flashes	Flashes green	Waiting for keyless.	Remove the key from the ignition switch and press a keyless button.
		The Programming button was held while powering up.	A reset occurred. Release the button. The LED should turn solid red.
 Solid x3 secs	Solid green for 3 seconds	Module was successfully programmed or is already programmed.	Normal operation.
 Solid x3 secs	Solid orange for 3 seconds	Types 1-5: Module was successfully programmed without diagnostics.	Normal operation.
Active Ground While Running			
 Off	Off	Ground While Running (status) off.	Make sure the module was programmed, i.e. the D2D harness is properly connected or the Ground While Running (status) wire is connected.
 Flashes	Flashes green	Ground While Running (status) on.	Normal operation.
Inactive Ground While Running			
 Flashes 1x	Flashes green once (1)	Lock function has been executed.	If it does not flash, the bypass module did not receive the signal. Verify the connections between the bypass and the remote starter module.
 Flashes 2x	Flashes green twice (2)	Unlock function has been executed.	If it does not flash, the bypass module did not receive the signal. Verify the connections between the bypass and the remote starter module.
 Flashes 3x	Flashes green three (3) times	Trunk release function has been executed.	If it does not flash, the bypass module did not receive the signal. Verify the connections between the bypass and the remote starter module.
 Flashes 4x	Flashes green four (4) times	AUX1 or AUX2 function has been executed.	If it does not flash, the bypass module did not receive the signal. Verify the connections between the bypass and the remote starter module.

Optional RF Kits

! **Note:** RF kits are sold SEPARATELY. Request an order from Directed using the part numbers listed below.

9211VL



Viper 1-way Responder ONE - Plug & Play RF kit with XL202.
UPC: **093207 08488 1**

Also available as:
▪ Python: 9211PL
▪ Clifford: 9211XL

9153VL



Viper 1-way - Plug & Play RF kit with XL202.
UPC: **093207 05660 4**

Also available as:
▪ Python: 9153PL
▪ Clifford: 9153XL

9251VL



Viper 2-way Responder LE - Plug & Play RF kit with XL202.
UPC: **093207 08489 8**

Also available as:
▪ Python: 9251PL
▪ Clifford: 9251XL

9752VL



Viper 2-way LC3 - Plug & Play RF kit with XL202.
UPC: **093207 08490 4**

Also available as:
▪ Python: 9752PL
▪ Clifford: 9752XL

Optional RF Kits

! **Note:** RF kits are sold SEPARATELY. Request an order from Directed using the part numbers listed below.

AF-RFK636



Astrostart 2-way LED Receiver kit with up to 1,500' of range.

UPC: 093207 08752 3

AF-RFK5225



Astrostart 2-way LCD Receiver kit offering XRT™ technology with up to 5,000' of range.

UPC: 093207 08753 0

AS-RFK1700



Autostart 1-way Receiver kit with up to 3,000' of range.

UPC: 093207 08738 7

AS-RFK2300



Autostart 2-way LED Receiver kit offering HDR™ technology with up to 3,000' of range.

UPC: 093207 08739 4

Using your DBALL-CHRYSLER RSR

- 1** Press the button to remote start the vehicle.
* Your remote starter model may differ from the one shown in the illustration.

Press button to
remote start** →



- 2** Enter the vehicle, while making sure the key is inside with you.

Enter vehicle
with the Smart
Key in hand

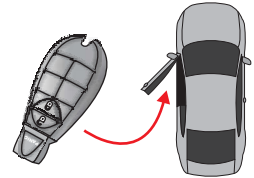

- 3** **Important:** Do NOT press the brake pedal.
Press the Push-to-Start (PTS) button twice to turn
the ignition ON.



Do NOT
press the
brake pedal

2X



- 4** You can now put the car in gear and drive off.

Ready to
drive off

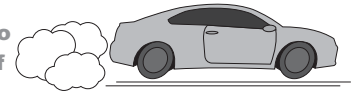

Limited One Year Consumer Warranty

For a period of ONE YEAR from the date of purchase of a Directed Electronics remote start or security product, Directed Electronics. ("DIRECTED") promises to the original purchaser, to repair or replace with a comparable reconditioned piece, the security or remote start accessory piece (hereinafter the "Part"), which proves to be defective in workmanship or material under normal use, provided the following conditions are met: the Part was purchased from an authorized DIRECTED dealer; and the Part is returned to DIRECTED, postage prepaid, along with a clear, legible copy of the receipt or bill of sale bearing the following information: consumer's name, address, telephone number, the authorized licensed dealer's name and complete product and Part description.

This warranty is nontransferable and is automatically void if the Part has been modified or used in a manner contrary to its intended purpose or the Part has been damaged by accident, unreasonable use, neglect, improper service, installation or other causes not arising out of defect in materials or construction.

TO THE MAXIMUM EXTENT ALLOWED BY LAW, EXCEPT AS STATED ABOVE, ALL WARRANTIES, INCLUDING BUT NOT LIMITED TO EXPRESS WARRANTY, IMPLIED WARRANTY, WARRANTY OF MERCHANTABILITY, FITNESS FOR PARTICULAR PURPOSE AND WARRANTY OF NON-INFRINGEMENT OF INTELLECTUAL PROPERTY, ARE EXPRESSLY EXCLUDED; AND DIRECTED NEITHER ASSUMES NOR AUTHORIZES ANY PERSON OR ENTITY TO ASSUME FOR IT ANY DUTY, OBLIGATION OR LIABILITY IN CONNECTION WITH ITS PRODUCTS. DIRECTED HEREBY DISCLAIMS AND HAS ABSOLUTELY NO LIABILITY FOR ANY AND ALL ACTS OF THIRD PARTIES INCLUDING DEALERS OR INSTALLERS. IN THE EVENT OF A CLAIM OR A DISPUTE INVOLVING DIRECTED OR ITS SUBSIDIARY, THE PROPER VENUE SHALL BE SAN DIEGO COUNTY IN THE STATE OF CALIFORNIA. CALIFORNIA STATE LAWS AND APPLICABLE FEDERAL LAWS SHALL APPLY AND GOVERN THE DISPUTE. THE MAXIMUM RECOVERY UNDER ANY CLAIM AGAINST DIRECTED SHALL BE STRICTLY LIMITED TO THE AUTHORIZED DIRECTED DEALER'S PURCHASE PRICE OF THE PART. DIRECTED SHALL NOT BE RESPONSIBLE FOR ANY DAMAGES WHATSOEVER, INCLUDING BUT NOT LIMITED TO, ANY CONSEQUENTIAL DAMAGES, INCIDENTAL DAMAGES, DAMAGES FOR THE LOSS OF TIME, LOSS OF EARNINGS, COMMERCIAL LOSS, LOSS OF ECONOMIC OPPORTUNITY AND THE LIKE. NOTWITHSTANDING THE ABOVE, THE MANUFACTURER DOES OFFER A LIMITED WARRANTY TO REPLACE OR REPAIR AT DIRECTED'S OPTION THE PART AS DESCRIBED ABOVE.

Some states do not allow limitations on how long an implied warranty will last or the exclusion or limitation of incidental or consequential damages. This warranty gives you specific legal rights and you may also have other rights that vary from State to State. DIRECTED does not and has not authorized any person or entity to create for it any other obligation, promise, duty or obligation in connection with this Part.

920-0007 2009-09

This Interface kit / Data Bus Interface part has been tested on the listed vehicles. Other vehicles will be added to the select vehicle list upon completion of compatibility testing. Visit website for latest vehicle application guide. **DISCLAIMER:** Under no circumstances shall the manufacturer or the distributors of the bypass kit / data bus interface part(s) be held liable for any consequential damages sustained in connection with the part(s) installation. The manufacturer and its distributors will not, nor will they authorize any representative or any other individual to assume obligation or liability in relation to the interface kit / data bus interface part(s) other than its replacement. **N.B.:** Under no circumstances shall the manufacturer and distributors of this product be liable for consequential damages sustained in connection with this product and neither assumes nor authorizes any representative or other person to assume for it any obligation or liability other than the replacement of this product only.

Protected by U.S. Patents: 5,719,551; 6,011,460 B1 *; 6,243,004 B1; 6,249,216 B1; 6,275,147 B1; 6,297,731 B1; 6,346,876 B1; 6,392,534 B1; 6,529,124 B2; 6,696,927 B2; 6,756,885 B1; 6,756,886 B2; 6,771,167 B1; 6,812,829 B1; 6,924,750 B1; 7,010,402 B1; 7,015,830 B1; 7,031,826 B1; 7,046,126 B1; 7,061,137 B1; 7,068,153 B1; 7,205,679 B1; Cdn. Patent: 2,320,248; 2,414,991; 2,415,011; 2,415,023; 2,415,027; 2,415,038; 2,415,041; 2,420,947; 2,426,670; 2,454,089; European Patent: 1,053,128; Pat. Pending: 2,291,306. Made in Canada.

Additional information can be found at:

www.xpresskit.com
www.directechs.com 

Free Manuals Download Website

<http://myh66.com>

<http://usermanuals.us>

<http://www.somanuals.com>

<http://www.4manuals.cc>

<http://www.manual-lib.com>

<http://www.404manual.com>

<http://www.luxmanual.com>

<http://aubethermostatmanual.com>

Golf course search by state

<http://golfingnear.com>

Email search by domain

<http://emailbydomain.com>

Auto manuals search

<http://auto.somanuals.com>

TV manuals search

<http://tv.somanuals.com>