



OWNER'S MANUAL

MAJESTY

YP400X

LIT-11626-21-34

Download from www.somanuals.com. All Manuals Search And Download.

5RU-28199-13

EAU10041

⚠ WARNING

The engine exhaust from this product contains chemicals known to the State of California to cause cancer, birth defects or other reproductive harm.

YAMAHA

LIT-CALIF-65-01

INTRODUCTION

EAU10090

Congratulations on your purchase of the Yamaha YP400X. This model is the result of Yamaha's vast experience in the production of fine sporting, touring, and pacesetting racing machines. It represents the high degree of craftsmanship and reliability that have made Yamaha a leader in these fields.



This manual will give you an understanding of the operation, inspection, and basic maintenance of this scooter. If you have any questions concerning the operation or maintenance of your scooter, please consult a Yamaha dealer.

The design and manufacture of this Yamaha scooter fully comply with the emissions standards for clean air applicable at the date of manufacture. Yamaha has met these standards without reducing the performance or economy of operation of the scooter. To maintain these high standards, it is important that you and your Yamaha dealer pay close attention to the recommended maintenance schedules and operating instructions contained within this manual.

IMPORTANT MANUAL INFORMATION

EAU35821

Particularly important information is distinguished in this manual by the following notations:

	The Safety Alert Symbol means ATTENTION! BECOME ALERT! YOUR SAFETY IS INVOLVED!
 WARNING	Failure to follow WARNING instructions <u>could result in severe injury or death to the scooter operator, a bystander, or a person inspecting or repairing the scooter.</u>
CAUTION:	A CAUTION indicates special precautions that must be taken to avoid damage to the scooter.
NOTE:	A NOTE provides key information to make procedures easier or clearer.

NOTE:

- This manual should be considered a permanent part of this scooter and should remain with it even if the scooter is subsequently sold.
- Yamaha continually seeks advancements in product design and quality. Therefore, while this manual contains the most current product information available at the time of printing, there may be minor discrepancies between your scooter and this manual. If you have any questions concerning this manual, please consult your Yamaha dealer.

EWA12580

WARNING

PLEASE READ THIS MANUAL AND THE “YOU AND YOUR MOTORCYCLE: RIDING TIPS” BOOKLET CAREFULLY AND COMPLETELY BEFORE OPERATING THIS SCOOTER. DO NOT ATTEMPT TO OPERATE THIS SCOOTER UNTIL YOU HAVE ATTAINED ADEQUATE KNOWLEDGE OF ITS CONTROLS AND OPERATING FEATURES AND UNTIL YOU HAVE BEEN TRAINED IN SAFE AND PROPER RIDING TECHNIQUES. REGULAR INSPECTIONS AND CAREFUL MAINTENANCE, ALONG WITH GOOD RIDING SKILLS, WILL ENSURE THAT YOU SAFELY ENJOY THE CAPABILITIES AND THE RELIABILITY OF THIS SCOOTER.

*Product and specifications are subject to change without notice.

IMPORTANT MANUAL INFORMATION

EAU10192

AFFIX DEALER
LABEL HERE

**YP400X
OWNER'S MANUAL
©2007 by Yamaha Motor Corporation, U.S.A.
1st edition, April 2007
All rights reserved.
Any reprinting or unauthorized use
without the written permission of
Yamaha Motor Corporation, U.S.A.
is expressly prohibited.
Printed in Japan.
P/N LIT-11626-21-34**

TABLE OF CONTENTS

SAFETY INFORMATION	1-1	PRE-OPERATION CHECKS	4-1	Checking the throttle cable free	
Further safe-riding points	1-4	Pre-operation check list	4-2	play	6-23
Location of important labels	1-6			Valve clearance	6-23
DESCRIPTION	2-1	OPERATION AND IMPORTANT		Tires	6-23
Left view	2-1	RIDING POINTS	5-1	Cast wheels	6-25
Right view	2-2	Starting the engine	5-1	Accessories and replacement	
Controls and instruments.....	2-3	Starting off	5-2	parts	6-26
INSTRUMENT AND CONTROL		Acceleration and deceleration	5-2	Front and rear brake lever free	
FUNCTIONS	3-1	Braking	5-2	play	6-26
Main switch/steering lock	3-1	Engine break-in	5-3	Adjusting the rear brake lock lever	
Indicator and warning lights	3-2	Parking	5-4	cable	6-27
Speedometer	3-2	PERIODIC MAINTENANCE AND		Checking the front and rear brake	
Tachometer	3-3	MINOR REPAIR	6-1	pads	6-28
Multi-function display	3-3	PERIODIC MAINTENANCE	6-1	Checking the brake fluid level	6-28
Handlebar switches	3-7	Owner's tool kit	6-2	Changing the brake fluid	6-29
Front brake lever	3-8	Periodic maintenance chart for the		Checking and lubricating the	
Rear brake lever	3-8	emission control system	6-3	cables	6-30
Rear brake lock lever	3-8	General maintenance and lubrication		Checking and lubricating the throttle	
Fuel tank cap	3-9	chart	6-4	grip and cable	6-30
Fuel	3-10	Removing and installing cowlings		Lubricating the front and rear brake	
Catalytic converter	3-11	and panels	6-8	levers	6-30
Seats	3-11	Checking the spark plug	6-12	Checking and lubricating the	
Adjusting the rider seat	3-13	Canister	6-14	centerstand and sidestand	6-31
Storage compartments	3-13	Engine oil and oil filter element	6-14	Checking the front fork	6-31
Adjusting the shock absorber		Final transmission oil	6-17	Checking the steering	6-32
assemblies	3-15	Coolant	6-18	Checking the wheel bearings	6-33
Sidestand	3-16	Air filter elements and check hoses		Battery	6-33
Ignition circuit cut-off system	3-16	and V-belt case air filter		Replacing the fuses	6-34
		element	6-20	Replacing a headlight bulb	6-36
				Tail/brake light	6-36

TABLE OF CONTENTS

Replacing a front turn signal light bulb	6-36
Replacing a rear turn signal light bulb	6-37
Replacing the license plate light bulb	6-38
Troubleshooting	6-39
Troubleshooting charts	6-40
SCOOTER CARE AND STORAGE	7-1
Matte color caution	7-1
Care	7-1
Storage	7-3
SPECIFICATIONS	8-1
CONSUMER INFORMATION	9-1
Identification numbers	9-1
Reporting safety defects	9-3
Scooter noise regulation	9-4
Maintenance record	9-5
YAMAHA MOTOR CORPORATION, U.S.A. STREET AND ENDURO MOTORCYCLE LIMITED WARRANTY	9-7
YAMAHA EXTENDED SERVICE (Y.E.S.)	9-9

SAFETY INFORMATION

EAU10261

SCOOTERS ARE SINGLE TRACK VEHICLES. THEIR SAFE USE AND OPERATION ARE DEPENDENT UPON THE USE OF PROPER RIDING TECHNIQUES AS WELL AS THE EXPERTISE OF THE OPERATOR. EVERY OPERATOR SHOULD KNOW THE FOLLOWING REQUIREMENTS BEFORE RIDING THIS SCOOTER.

HE OR SHE SHOULD:

- OBTAIN THOROUGH INSTRUCTIONS FROM A COMPETENT SOURCE ON ALL ASPECTS OF SCOOTER OPERATION.
- OBSERVE THE WARNINGS AND MAINTENANCE REQUIREMENTS IN THE OWNER'S MANUAL.
- OBTAIN QUALIFIED TRAINING IN SAFE AND PROPER RIDING TECHNIQUES.
- OBTAIN PROFESSIONAL TECHNICAL SERVICE AS INDICATED BY THE OWNER'S MANUAL AND/OR WHEN MADE NECESSARY BY MECHANICAL CONDI-

TIONS.

Safe riding

- Always make pre-operation checks. Careful checks may help prevent an accident.
- This scooter is designed to carry the operator and passenger.
- The failure of motorists to detect and recognize scooters in traffic is the predominating cause of automobile/scooter accidents. Many accidents have been caused by an automobile driver who did not see the scooter. Making yourself conspicuous appears to be very effective in reducing the chance of this type of accident.
- **Therefore:**
 - Wear a brightly colored jacket.
 - Use extra caution when approaching and passing through intersections, since intersections are the most likely places for scooter accidents to occur.
 - Ride where other motorists can see you. Avoid riding in another motorist's blind spot.

- Many accidents involve inexperienced operators. In fact, many operators who have been involved in accidents do not even have a current driver's license.
- Make sure that you are qualified and that you only lend your scooter to other qualified operators.
- Know your skills and limits. Staying within your limits may help you to avoid an accident.
- We recommend that you practice riding your scooter where there is no traffic until you have become thoroughly familiar with the scooter and all of its controls.
- Many accidents have been caused by error of the scooter operator. A typical error made by the operator is veering wide on a turn due to EXCESSIVE SPEED or undercornering (insufficient lean angle for the speed).
- Always obey the speed limit and never travel faster than warranted by road and traffic conditions.

- Always signal before turning or changing lanes. Make sure that other motorists can see you.
- The posture of the operator and passenger is important for proper control.
- The operator should keep both hands on the handlebar and both feet on the footboard during operation to maintain control of the scooter.
- The passenger should always hold onto the operator, the seat strap or grab bar, if equipped, with both hands and keep both feet on the passenger footrests.
- Never carry a passenger unless he or she can firmly place both feet on the passenger footrests.
- Never ride under the influence of alcohol or other drugs.
- This scooter is designed for on-road use only. It is not suitable for off-road use.

Protective apparel

The majority of fatalities from scooter accidents are the result of head injuries.

The use of a safety helmet is the single most critical factor in the prevention or reduction of head injuries.

- Always wear an approved helmet.
- Wear a face shield or goggles. Wind in your unprotected eyes could contribute to an impairment of vision which could delay seeing a hazard.
- The use of a jacket, substantial shoes, trousers, gloves, etc., is effective in preventing or reducing abrasions or lacerations.
- Never wear loose-fitting clothes, otherwise they could catch on the control levers or wheels and cause injury or an accident.
- Never touch the engine or exhaust system during or after operation. They become very hot and can cause burns. Always wear protective clothing that covers your legs, ankles, and feet.
- Passengers should also observe the above precautions.

Modifications

Modifications made to this scooter not

approved by Yamaha, or the removal of original equipment, may render the scooter unsafe for use and may cause severe personal injury. Modifications may also make your scooter illegal to use.

Loading and accessories

Adding accessories or cargo to your scooter can adversely affect stability and handling if the weight distribution of the scooter is changed. To avoid the possibility of an accident, use extreme caution when adding cargo or accessories to your scooter. Use extra care when riding a scooter that has added cargo or accessories. Here are some general guidelines to follow if loading cargo or adding accessories to your scooter:

Loading

The total weight of the operator, passenger, accessories and cargo must not exceed the maximum load limit.

Maximum load: 196 kg (432 lb)

SAFETY INFORMATION

When loading within this weight limit, keep the following in mind:

- Cargo and accessory weight should be kept as low and close to the scooter as possible. Make sure to distribute the weight as evenly as possible on both sides of the scooter to minimize imbalance or instability.
- Shifting weights can create a sudden imbalance. Make sure that accessories and cargo are securely attached to the scooter before riding. Check accessory mounts and cargo restraints frequently.
- Never attach any large or heavy items to the handlebar, front fork, or front fender. Such items can create unstable handling or a slow steering response.

Accessories

Genuine Yamaha accessories have been specifically designed for use on this scooter. Since Yamaha cannot test all other accessories that may be available, you must personally be responsible for the proper selection, installation

and use of non-Yamaha accessories. Use extreme caution when selecting and installing any accessories.

Keep the following guidelines in mind, as well as those provided under “Loading” when mounting accessories.

- Never install accessories or carry cargo that would impair the performance of your scooter. Carefully inspect the accessory before using it to make sure that it does not in any way reduce ground clearance or cornering clearance, limit suspension travel, steering travel or control operation, or obscure lights or reflectors.
- Accessories fitted to the handlebar or the front fork area can create instability due to improper weight distribution or aerodynamic changes. If accessories are added to the handlebar or front fork area, they must be as lightweight as possible and should be kept to a minimum.
- Bulky or large accessories may seriously affect the stability of the scooter due to aerodynamic

effects. Wind may attempt to lift the scooter, or the scooter may become unstable in cross winds. These accessories may also cause instability when passing or being passed by large vehicles.

- Certain accessories can displace the operator from his or her normal riding position. This improper position limits the freedom of movement of the operator and may limit control ability, therefore, such accessories are not recommended.
- Use caution when adding electrical accessories. If electrical accessories exceed the capacity of the scooter’s electrical system an electric failure could result, which could cause a dangerous loss of lights or engine power.

Gasoline and exhaust gas

- **GASOLINE IS HIGHLY FLAMMABLE:**
 - Always turn the engine off when refueling.

Further safe-riding points

- Take care not to spill any gasoline on the engine or exhaust system when refueling.
 - Never refuel while smoking or in the vicinity of an open flame.
 - Never start the engine or let it run for any length of time in a closed area. The exhaust fumes are poisonous and may cause loss of consciousness and death within a short time. Always operate your scooter in an area that has adequate ventilation.
 - Always turn the engine off before leaving the scooter unattended and remove the key from the main switch. When parking the scooter, note the following:
 - The engine and exhaust system may be hot, therefore, park the scooter in a place where pedestrians or children are not likely to touch these hot areas.
 - Do not park the scooter on a slope or soft ground, otherwise it may fall over.
 - Do not park the scooter near a flammable source (e.g., a kerosene heater, or near an open flame), otherwise it could catch fire.
 - If you should swallow any gasoline, inhale a lot of gasoline vapor, or allow gasoline to get into your eyes, see your doctor immediately. If any gasoline spills on your skin or clothing, immediately wash the affected area with soap and water and change your clothes.
- Be sure to signal clearly when making turns.
 - Braking can be extremely difficult on a wet road. Avoid hard braking, because the scooter could slide. Apply the brakes slowly when stopping on a wet surface.
 - Slow down as you approach a corner or turn. Once you have completed a turn, accelerate slowly.
 - Be careful when passing parked cars. A driver might not see you and open a door in your path.
 - Railroad crossings, streetcar rails, iron plates on road construction sites, and manhole covers become extremely slippery when wet. Slow down and cross them with caution. Keep the scooter upright, otherwise it could slide out from under you.
 - The brake pads could get wet when you wash the scooter. After washing the scooter, check the brakes before riding.
 - Always wear a helmet, gloves, trousers (tapered around the cuff

SAFETY INFORMATION

and ankle so they do not flap), and a bright colored jacket.

- Do not carry too much luggage on the scooter. An overloaded scooter is unstable.

Location of important labels

Please read the following important labels carefully before operating this vehicle.

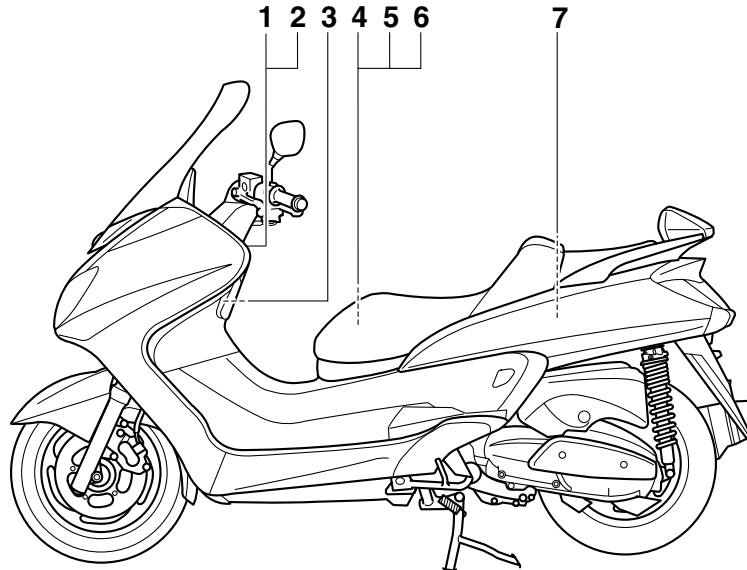

SAFETY INFORMATION

1

CAUTION

- Cleaning with alkaline or acid cleaner, gasoline or solvent will damage windshield.
- Use neutral detergent.

3JJ-2835Y-A0

2

 **WARNING**

- **BEFORE YOU OPERATE THIS VEHICLE, READ THE OWNER'S MANUAL AND ALL LABELS.**
- **ALWAYS WEAR AN APPROVED MOTORCYCLE HELMET**, eye protection, and protective clothing.

5GK-2119K-00

3

LOAD LIMIT

2 kg {4 lbs}

5RU-24877-A0

4

TIRE INFORMATION

Cold tire normal pressure should be set as follows.

- Up to 90kg (198 lbs) load
FRONT : 200 kPa, {2.00 kgf/cm²}, 29 psi
REAR : 250 kPa, {2.50 kgf/cm²}, 36 psi
- 90kg (198 lbs) ~ maximum load
FRONT : 200 kPa, {2.00 kgf/cm²}, 29 psi
REAR : 250 kPa, {2.50 kgf/cm²}, 36 psi

5RU-21668-00

5

 **WARNING**

Improper loading can cause loss of control.
Read owner's manual for proper loading.

3JJ-28446-A1

6

LOAD LIMIT

5 kg {11 lbs}

3LD-24877-A0

7

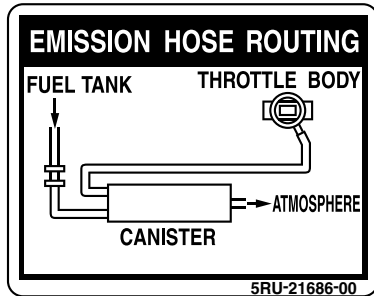

1

DESCRIPTION

EAU10410

Left view

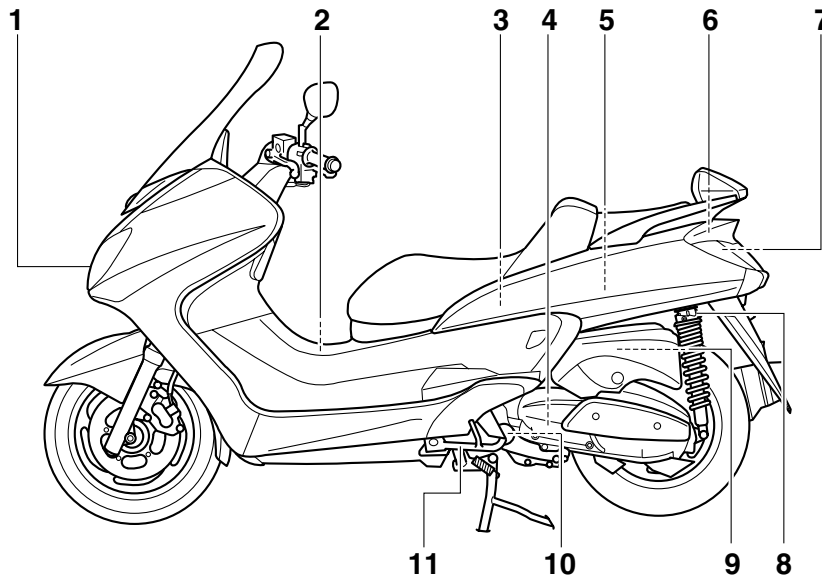

1. Headlight (page 6-36)
2. Fuel tank cap (page 3-9)
3. Rear storage compartment (page 3-13)
4. V-belt case air filter element (page 6-20)
5. Owner's tool kit (page 6-2)
6. Fuses (page 6-34)
7. Battery (page 6-33)
8. Shock absorber assembly spring preload adjusting ring (page 3-15)
9. Air filter element (left) (page 6-20)
10. Engine oil filter element (page 6-14)
11. Sidestand (page 3-16, 6-31)

Right view

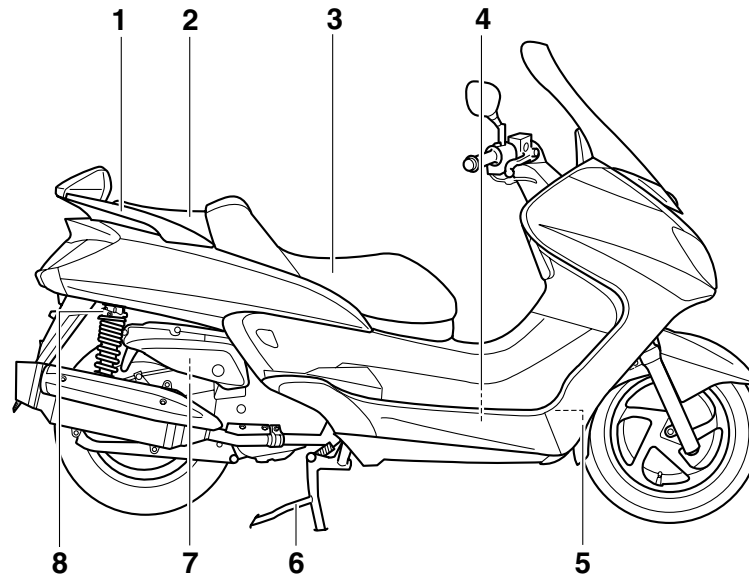

1. Grab bar (page 5-2)
2. Passenger seat (page 3-11)
3. Rider seat (page 3-11)
4. Coolant reservoir (page 6-18)
5. Radiator
6. Centerstand (page 6-31)
7. Air filter element (right) (page 6-20)
8. Shock absorber assembly spring preload adjusting ring (page 3-15)

DESCRIPTION

EAU10430

Controls and instruments

2

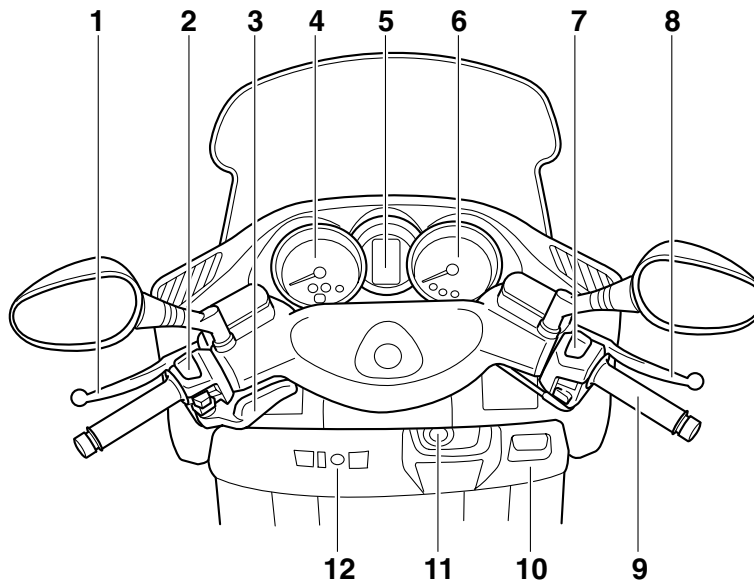

1. Rear brake lever (page 3-8)
2. Left handlebar switches (page 3-7)
3. Rear brake lock lever (page 3-8)
4. Speedometer (page 3-2)
5. Multi-function display (page 3-3)
6. Tachometer (page 3-3)
7. Right handlebar switches (page 3-7)
8. Front brake lever (page 3-8)

9. Throttle grip (page 6-23)
10. Front storage compartment B (page 3-13)
11. Main switch/steering lock (page 3-1)
12. Front storage compartment A (page 3-13)

INSTRUMENT AND CONTROL FUNCTIONS

Main switch/steering lock

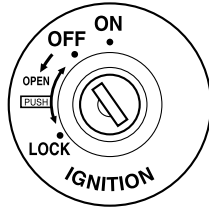

The main switch/steering lock controls the ignition and lighting systems, and is used to lock the steering. The various positions are described below.

ON

All electrical circuits are supplied with power; the meter lighting, taillight, license plate light and position lights come on, and the engine can be started. The key cannot be removed.

NOTE:

The headlights come on automatically when the engine is started and stay on until the key is turned to “OFF” or the

EAU10460

sidestand is moved down.

OFF

All electrical systems are off. The key can be removed.

EAU10660

LOCK

The steering is locked, and all electrical systems are off. The key can be removed.

EAU10680

To lock the steering

1. Turn the handlebars all the way to the left.
2. Push the key in from the “OFF” position, and then turn it to “LOCK” while still pushing it.
3. Remove the key.

To unlock the steering

Push the key in, and then turn it to “OFF” while still pushing it.

EWA10060



Never turn the key to “OFF” or “LOCK” while the vehicle is moving, otherwise the electrical systems will be switched off, which may result in

loss of control or an accident. Make sure that the vehicle is stopped before turning the key to “OFF” or “LOCK”.

INSTRUMENT AND CONTROL FUNCTIONS

Indicator and warning lights

EAU11003

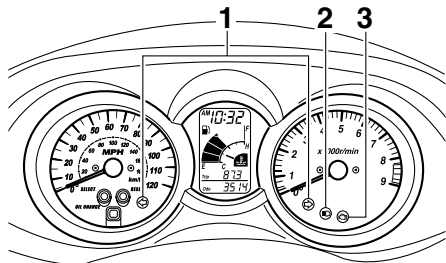

1. Turn signal indicator lights “” and “”
2. High beam indicator light “”
3. Engine trouble warning light “”

Turn signal indicator lights “” and “”

EAU11030

The corresponding indicator light flashes when the turn signal switch is pushed to the left or right.

High beam indicator light “”

EAU11080

This indicator light comes on when the high beam of the headlight is switched on.

Engine trouble warning light “”

EAU11480

This warning light comes on when an electrical circuit monitoring the engine is defective. When this occurs, have a Yamaha dealer check the self-diagnosis system.

The electrical circuit of the warning light can be checked by turning the key to “ON”. If the warning light does not come on for a few seconds, then go off, have a Yamaha dealer check the electrical circuit.

Speedometer

EAU11601

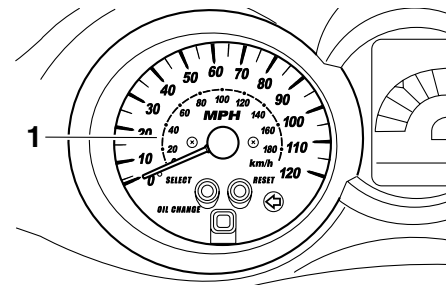

1. Speedometer

The speedometer shows the riding speed.

When the key is turned to “ON”, the speedometer needle will sweep once across the speed range and then return to zero in order to test the electrical circuit.

INSTRUMENT AND CONTROL FUNCTIONS

Tachometer

EAU11872

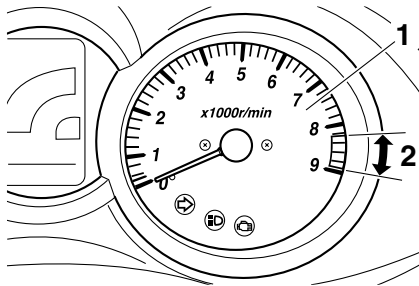

1. Tachometer
2. Tachometer red zone

The electric tachometer allows the rider to monitor the engine speed and keep it within the ideal power range.

When the key is turned to "ON", the tachometer needle will sweep once across the r/min range and then return to zero r/min in order to test the electrical circuit.

CAUTION:

Do not operate the engine in the tachometer red zone.

Red zone: 8250 r/min and above

ECA10031

Multi-function display

EAU36105

EWA12311



Be sure to stop the vehicle before making any setting changes to the multi-function display.

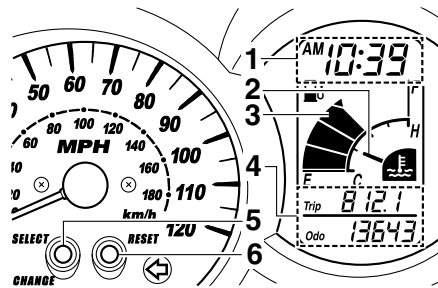

1. Clock/ambient temperature display
2. Coolant temperature meter
3. Fuel meter
4. Odometer/tripmeters
5. "SELECT" button
6. "RESET" button

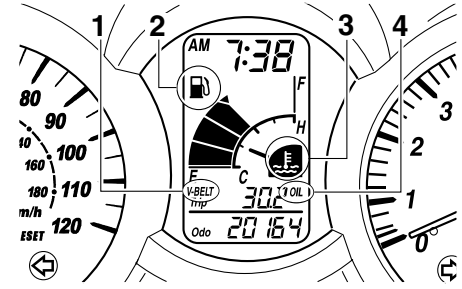

1. V-belt replacement indicator "V-BELT"
2. Fuel level warning indicator "⛽"
3. Coolant temperature warning indicator "⊖"
4. Oil change indicator "OIL"

The multi-function display is equipped with the following:

- a fuel meter
- a coolant temperature meter
- an odometer (which shows the total distance traveled)
- two tripmeters (which show the distance traveled since they were last set to zero)
- a fuel reserve tripmeter (which shows the distance traveled since the bottom segment of the fuel meter and fuel level warning indi-

3

INSTRUMENT AND CONTROL FUNCTIONS

- cator started flashing)
- a self-diagnosis device
- a clock
- an ambient temperature display
- an oil change indicator
- a V-belt replacement indicator

NOTE:

- Be sure to turn the key to “ON” before using the “SELECT” and “RESET” buttons.
- When the key is turned to “ON”, all of the display segments of the multi-function display will appear one after the other and then disappear, in order to test the electrical circuit.

Odometer and tripmeter modes

Pushing the “SELECT” button switches the display between the odometer mode “ODO” and the tripmeter modes “TRIP” in the following order:

ODO → TRIP (top) → TRIP (bottom) → ODO

When approximately 2.8 L (0.74 US gal) (0.62 Imp.gal) of fuel remains in the fuel tank, the bottom segment of the fuel meter and fuel level warning indicator

will start flashing, and the display will automatically change to the fuel reserve tripmeter mode “TRIP F” and start counting the distance traveled from that point. In that case, pushing the “SELECT” button switches the display between the various tripmeter and odometer modes in the following order: TRIP F → TRIP (top) → TRIP (bottom) → ODO → TRIP F

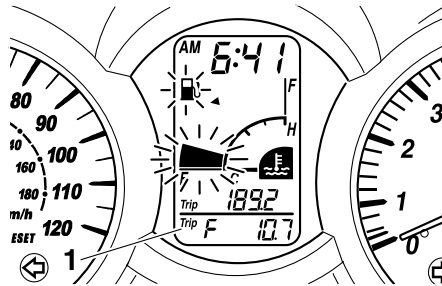

1. Fuel reserve tripmeter

To reset a tripmeter, select it by pushing the “SELECT” button until “TRIP” or “TRIP F” begins flashing (“TRIP” or “TRIP F” will only flash for five seconds). While “TRIP” or “TRIP F” is flashing, push the “RESET” button for at least one second. If you do not reset

the fuel reserve tripmeter manually, it will reset itself automatically and the display will return to the prior mode after refueling and traveling 5 km (3 mi).

NOTE:

The display cannot be changed back to “TRIP F” after pushing the “RESET” button.

Fuel meter

With the key in the “ON” position, the fuel meter indicates the amount of fuel in the fuel tank. The display segments of the fuel meter disappear towards “E” (Empty) as the fuel level decreases. When the fuel level reaches the bottom segment near “E”, the fuel level warning indicator and the bottom segment will flash. Refuel as soon as possible.

Coolant temperature meter

With the key in the “ON” position, the coolant temperature meter indicates the temperature of the coolant. The coolant temperature varies with changes in the weather and engine load. If the top segment and coolant temperature warning indicator flash, stop the

INSTRUMENT AND CONTROL FUNCTIONS

vehicle and let the engine cool. (See page 6-40.)

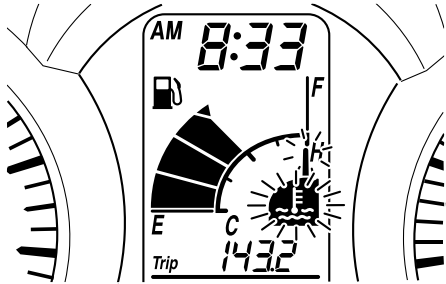

ECA10020

CAUTION:

Do not operate the engine if it is overheated.

Oil change indicator “OIL”

This indicator flashes at the initial 1000 km (600 mi), then at 5000 km (3000 mi) and every 5000 km (3000 mi) thereafter to indicate that the engine oil should be changed.

After changing the engine oil, reset the oil change indicator. (See page 6-14.)

If the engine oil is changed before the oil change indicator comes on (i.e. before the periodic oil change interval has

been reached), the indicator must be reset after the oil change for the next periodic oil change to be indicated at the correct time. (See page 6-14.)

The electrical circuit of the indicator can be checked according to the following procedure.

1. Set the engine stop switch to “○” and turn the key to “ON”.
2. Check that the indicator comes on for a few seconds and then goes off.
3. If the indicator does not come on, have a Yamaha dealer check the electrical circuit.

NOTE:

The oil change indicator may flash when the engine is revved with the scooter on the centerstand, but this does not indicate a malfunction.

V-belt replacement indicator “V-BELT”

This indicator flashes every 20000 km (12500 mi) when the V-belt needs to be replaced.

The electrical circuit of the indicator can be checked according to the following

procedure.

1. Turn the key to “ON” and make sure that the engine stop switch is set to “○”.
2. If the indicator does not come on, have a Yamaha dealer check the electrical circuit.

Self-diagnosis device

This model is equipped with a self-diagnosis device for various electrical circuits.

If any of those circuits are defective, the multi-function display will indicate a two-digit error code.

If the multi-function display indicates such an error code, note the code number, and then have a Yamaha dealer check the vehicle.

INSTRUMENT AND CONTROL FUNCTIONS

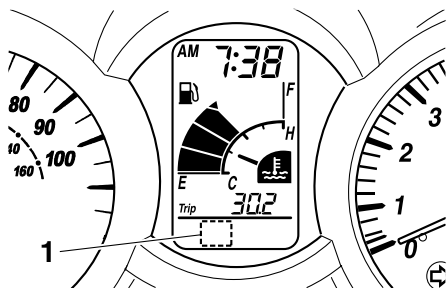

1. Error code display

ECA11790

CAUTION:

If the multi-function display indicates an error code, the vehicle should be checked as soon as possible in order to avoid engine damage.

Clock mode

To set the clock:

1. Push the “SELECT” button and “RESET” button together for at least two seconds.
2. When the hour digits start flashing, push the “RESET” button to set the hours.
3. Push the “SELECT” button, and

- the minute digits will start flashing.
4. Push the “RESET” button to set the minutes.
5. Push the “SELECT” button and then release it to start the clock. Pushing the “SELECT” button for at least two seconds switches the clock display to the ambient temperature display.

will not be displayed.

- The accuracy of the temperature reading may be affected when riding slowly (approximately under 20 km/h (12.5 mi/h)) or when stopped at traffic signals, railroad crossings, etc.

Ambient temperature display

This display shows the ambient temperature from -10°C (14°F) to 50°C (122°F) in 1°C or 1°F increments. The temperature displayed may vary from the ambient temperature. Pushing the “SELECT” button for at least two seconds switches the ambient temperature display to the clock display.

NOTE:

- If the ambient temperature falls below -10°C (14°F), a lower temperature than -10°C (14°F) will not be displayed.
- If the ambient temperature climbs above 50°C (122°F), a higher temperature than 50°C (122°F)

INSTRUMENT AND CONTROL FUNCTIONS

Handlebar switches

Left

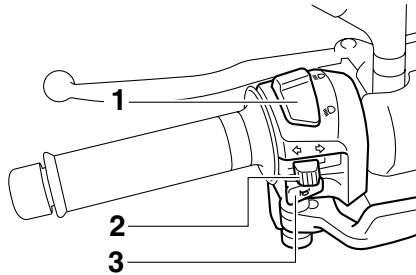

1. Dimmer switch “/”
2. Turn signal switch “/”
3. Horn switch “”

EAU12347

Right

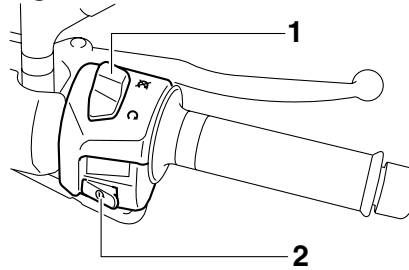

1. Engine stop switch “/”
2. Start switch “”

EAU12400

Dimmer switch “/”

Set this switch to “” for the high beam and to “” for the low beam.

EAU12460

Turn signal switch “/”

To signal a right-hand turn, push this switch to “”. To signal a left-hand turn, push this switch to “”. When released, the switch returns to the center position. To cancel the turn signal lights, push the switch in after it has returned to the center position.

EAU12500

Horn switch “”

Press this switch to sound the horn.

EAU12660

Engine stop switch “/”

Set this switch to “” before starting the engine. Set this switch to “” to stop the engine in case of an emergency, such as when the vehicle overturns or when the throttle cable is stuck.

3

EAU12720

Start switch “”

With the sidestand up, push this switch while applying the front or rear brake to crank the engine with the starter.

ECA10050

CAUTION:

See page 5-1 for starting instructions prior to starting the engine.

INSTRUMENT AND CONTROL FUNCTIONS

Front brake lever

EAU12900

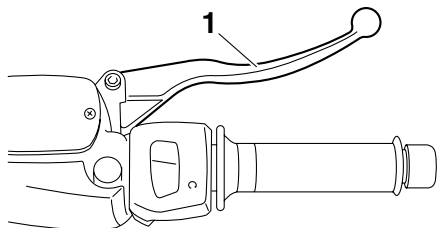

1. Front brake lever

The front brake lever is located on the right handlebar grip. To apply the front brake, pull this lever toward the handlebar grip.

Rear brake lever

EAU12950

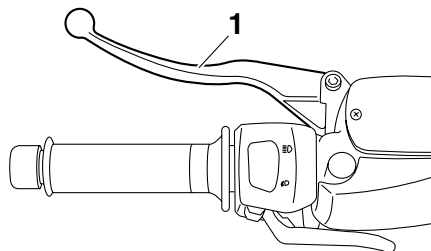

1. Rear brake lever

The rear brake lever is located on the left handlebar grip. To apply the rear brake, pull this lever toward the handlebar grip.

Rear brake lock lever

EAU12962

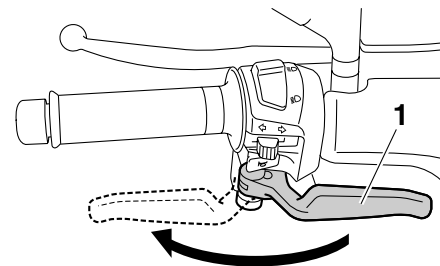

1. Rear brake lock lever

This vehicle is equipped with a rear brake lock lever to prevent the rear wheel from moving while stopped at traffic signals, railroad crossings, etc.

To lock the rear wheel

Push the rear brake lock lever to the left until it snaps into place.

To unlock the rear wheel

Push the rear brake lock lever back to the original position.

NOTE: _____

- Be sure to check that the rear wheel does not move when the

INSTRUMENT AND CONTROL FUNCTIONS

rear brake lock lever is applied.

- To provide secure locking of the rear wheel, apply the rear brake lever first before moving the rear brake lock lever to the left.

WARNING

Never move the rear brake lock lever to the left while the vehicle is moving, otherwise loss of control or an accident may result. Make sure that the vehicle is stopped before moving the rear brake lock lever to the left.

EWA12361

Fuel tank cap

EAU13162

To open the fuel tank cap

1. Open the lid by sliding the lever forward, and then pull the lever up.

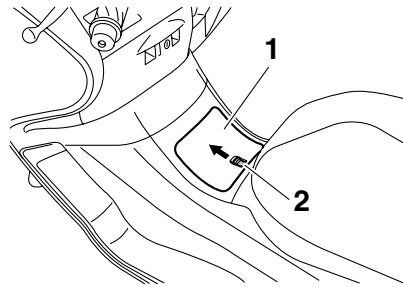

1. Lid
2. Opening lever

2. Insert the key into the lock and turn it clockwise. The lock will be released and the fuel tank cap can be removed.

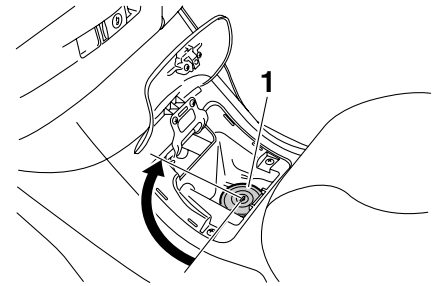

1. Fuel tank cap

To install the fuel tank cap

1. Align the match marks, insert the fuel tank cap into the tank opening, and then push down on the cap.

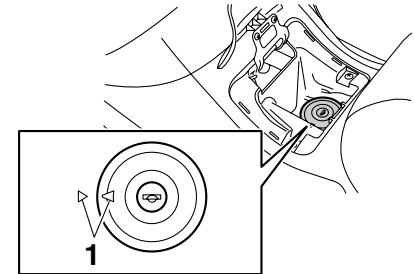

1. Match marks

2. Turn the key counterclockwise to the original position, and then re-

INSTRUMENT AND CONTROL FUNCTIONS

move it.

3. Close the lid.

EWA11120

WARNING

Be sure that the fuel tank cap is properly installed and locked before riding the scooter.

3

Fuel

EAU13211

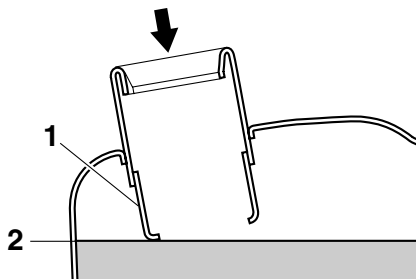

1. Fuel tank filler tube
2. Fuel level

Make sure that there is sufficient fuel in the tank. Fill the fuel tank to the bottom of the filler tube as shown.

EWA10880

WARNING

- Do not overfill the fuel tank, otherwise it may overflow when the fuel warms up and expands.
- Avoid spilling fuel on the hot engine.

ECA10070

CAUTION:

Immediately wipe off spilled fuel with a clean, dry, soft cloth, since

fuel may deteriorate painted surfaces or plastic parts.

EAU36080

Recommended fuel
UNLEADED GASOLINE ONLY
Fuel tank capacity:
14.0 L (3.70 US gal) (3.08 Imp.gal)

ECA11400

CAUTION:

Use only unleaded gasoline. The use of leaded gasoline will cause severe damage to internal engine parts, such as the valves and piston rings, as well as to the exhaust system.

Your Yamaha engine has been designed to use regular unleaded gasoline with a pump octane number $[(R+M)/2]$ of 86 or higher, or a research octane number of 91 or higher. If knocking (or pinging) occurs, use a gasoline of a different brand or premium unleaded fuel. Use of unleaded fuel will extend spark plug life and reduce maintenance costs.

Gasohol

There are two types of gasohol: gasohol containing ethanol and that containing methanol. Gasohol containing ethanol can be used if the ethanol content does not exceed 10%. Gasohol containing methanol is not recommended by Yamaha because it can cause damage to the fuel system or vehicle performance problems.

Catalytic converter

EAU13431

This model is equipped with a catalytic converter in the exhaust system.

EWA10860

⚠ WARNING

The exhaust system is hot after operation. Make sure that the exhaust system has cooled down before doing any maintenance work.

ECA10700

CAUTION:

The following precautions must be observed to prevent a fire hazard or other damages.

- **Use only unleaded gasoline. The use of leaded gasoline will cause unreparable damage to the catalytic converter.**
- **Never park the vehicle near possible fire hazards such as grass or other materials that easily burn.**
- **Do not allow the engine to idle too long.**

Seats

EAU34140

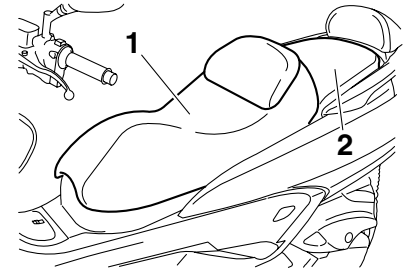

1. Rider seat
2. Passenger seat

Rider seat

To open the rider seat

1. Place the scooter on the center-stand.
2. Insert the key into the main switch, and then turn it counterclockwise.

INSTRUMENT AND CONTROL FUNCTIONS

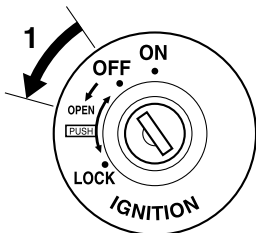

1. Open.

NOTE: _____

Do not push inward when turning the key.

3. Fold the rider seat up.

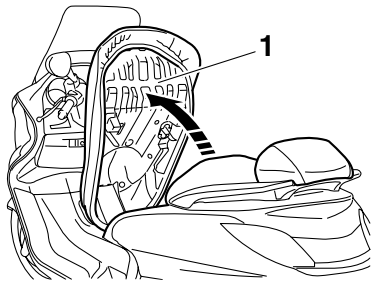

1. Rider seat

To close the rider seat

1. Fold the rider seat down, and then push it down to lock it in place.
2. Remove the key from the main switch if the scooter will be left unattended.

NOTE: _____
Make sure that the rider seat is properly secured before riding.

Passenger seat

To remove the passenger seat

1. Open the rider seat.
2. Remove the bolt, and then pull the passenger seat forward.

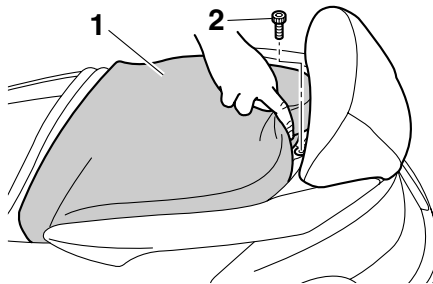

1. Passenger seat
2. Bolt

To install the passenger seat

1. Insert the projections on the passenger seat into the holders as shown, place the passenger seat in the original position, and then install the bolt.

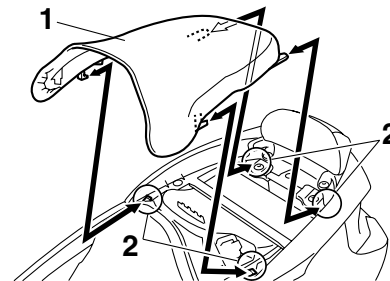

1. Passenger seat
2. Seat holder

2. Close the rider seat.

NOTE: _____
Make sure that the passenger seat is properly secured before riding.

EAU34150

Adjusting the rider seat

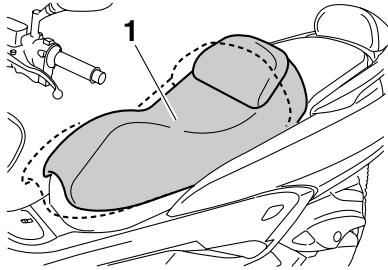

1. Rider seat

The rider seat can be adjusted as follows to change the riding position.

1. Open the rider seat. (See page 3-11.)
2. Remove the bolts.

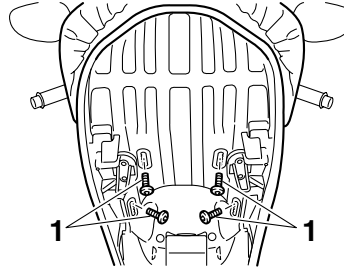

1. Bolt

3. Slide the rider seat forward or backward to the desired position.
4. Install bolts and securely tighten them.
5. Close the rider seat.

Storage compartments

EAU14492

Front storage compartment A

To open the storage compartment when it is locked, insert the key in the lock, turn it counterclockwise, and then grasp the lock while pushing the button in.

To open the storage compartment when it is unlocked, simply grasp the lock while pushing the button in.

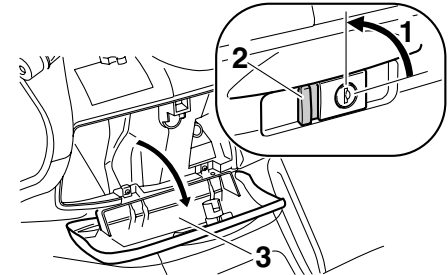

1. Open.
2. Button
3. Lid

To lock the storage compartment, push the lid into the original position, insert the key in the lock, turn it clockwise,

INSTRUMENT AND CONTROL FUNCTIONS

and then remove it.

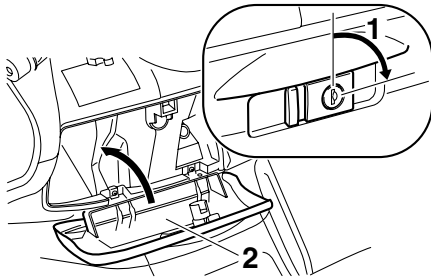

1. Lock.
2. Lid

Front storage compartment B

To open the storage compartment, slide the lever up, and then pull on the lever.

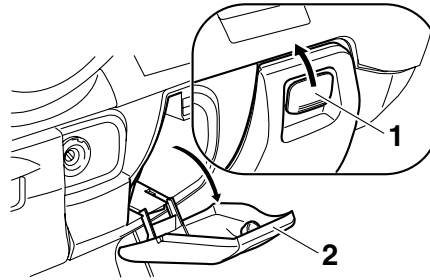

1. Storage compartment opening lever
2. Lid

To close the storage compartment, push the lid into the original position.

EWA11160



Do not store heavy items in this compartment.

Rear storage compartment

Two helmets can be stored in the storage compartment under the seats. (See page 3-11.)

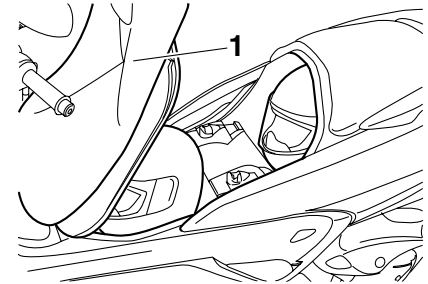

1. Rider seat

CAUTION:

Keep the following points in mind when using the storage compartment.

- Since the storage compartment accumulates heat when exposed to the sun, do not store anything susceptible to heat inside it.
- To avoid humidity from spreading through the storage compartment, wrap wet articles in a plastic bag before storing them in the compartment.
- Since the storage compartment may get wet while the scooter is

ECA10080

INSTRUMENT AND CONTROL FUNCTIONS

being washed, wrap any articles stored in the compartment in a plastic bag.

- Do not keep anything valuable or breakable in the storage compartment.

ECA11100

CAUTION:

Do not leave the rider seat open for an extended period of time, otherwise the light may cause the battery to discharge.

EWA11170

WARNING

Do not exceed the following loading limits:

- Front storage compartment A: 2 kg (4 lb)
- Rear storage compartment: 5 kg (11 lb)
- Maximum load for the vehicle: 196 kg (432 lb)

EAU14890

Adjusting the shock absorber assemblies

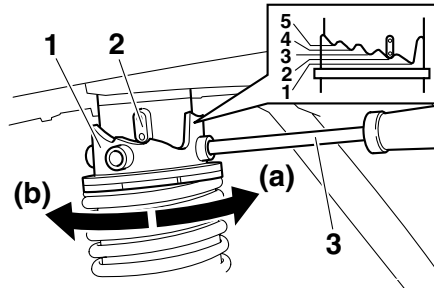

1. Spring preload adjusting ring
2. Position indicator
3. Spring preload adjusting tool

Each shock absorber assembly is equipped with a spring preload adjusting ring.

ECA10100

CAUTION:

Never attempt to turn an adjusting mechanism beyond the maximum or minimum settings.

EWA10210

WARNING

Always adjust both shock absorber assemblies equally, otherwise poor

handling and loss of stability may result.

Adjust the spring preload as follows.

To increase the spring preload and thereby harden the suspension, turn the adjusting ring on each shock absorber assembly in direction (a). To decrease the spring preload and thereby soften the suspension, turn the adjusting ring on each shock absorber assembly in direction (b).

NOTE:

- Align the appropriate notch in the adjusting ring with the position indicator on the shock absorber.
- Use the spring preload adjusting tool included in the owner's tool kit to make this adjustment.

Spring preload setting:

Minimum (soft):

1

Standard:

2

Maximum (hard):

5

INSTRUMENT AND CONTROL FUNCTIONS

Sidestand

EAU15301

The sidestand is located on the left side of the frame. Raise the sidestand or lower it with your foot while holding the vehicle upright.

NOTE:

The built-in sidestand switch is part of the ignition circuit cut-off system, which cuts the ignition in certain situations. (See further down for an explanation of the ignition circuit cut-off system.)

EWA10240

WARNING

The vehicle must not be ridden with the sidestand down, or if the sidestand cannot be properly moved up (or does not stay up), otherwise the sidestand could contact the ground and distract the operator, resulting in a possible loss of control. Yamaha's ignition circuit cut-off system has been designed to assist the operator in fulfilling the responsibility of raising the sidestand before starting off. Therefore, check this system regularly as described below and have a Yamaha dealer re-

pair it if it does not function properly.

EAU15372

Ignition circuit cut-off system

The ignition circuit cut-off system (comprising the sidestand switch and brake light switches) has the following functions.

- It prevents starting when the sidestand is up, but neither brake is applied.
- It prevents starting when either brake is applied, but the sidestand is still down.
- It cuts the running engine when the sidestand is moved down.

Periodically check the operation of the ignition circuit cut-off system according to the following procedure.

EWA10250

WARNING

If a malfunction is noted, have a Yamaha dealer check the system before riding.

INSTRUMENT AND CONTROL FUNCTIONS

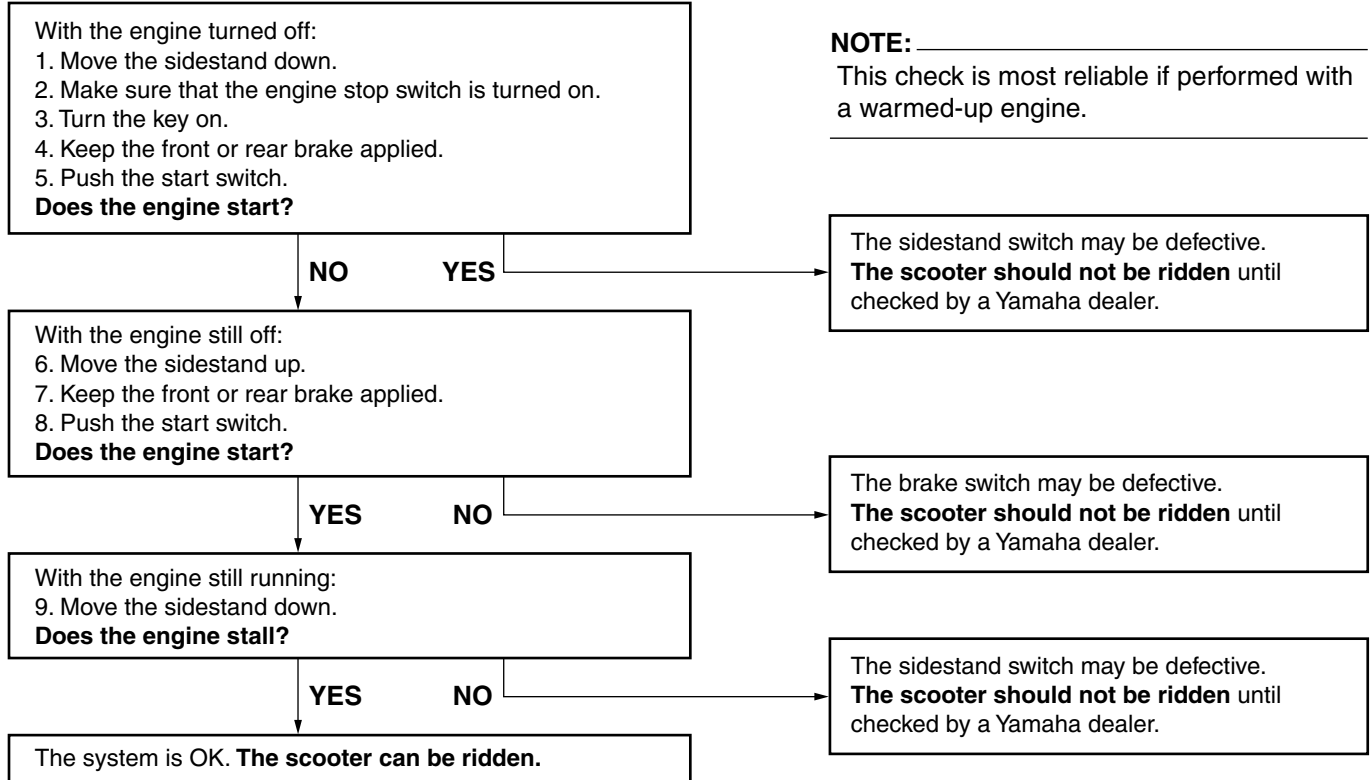

PRE-OPERATION CHECKS

EAU15593

The condition of a vehicle is the owner's responsibility. Vital components can start to deteriorate quickly and unexpectedly, even if the vehicle remains unused (for example, as a result of exposure to the elements). Any damage, fluid leakage or loss of tire air pressure could have serious consequences. Therefore, it is very important, in addition to a thorough visual inspection, to check the following points before each ride.

NOTE: _____

Pre-operation checks should be made each time the vehicle is used. Such an inspection can be accomplished in a very short time; and the added safety it assures is more than worth the time involved.

EWA11150

⚠ WARNING _____

4

If any item in the Pre-operation check list is not working properly, have it inspected and repaired before operating the vehicle.

PRE-OPERATION CHECKS

EAU15605

Pre-operation check list

ITEM	CHECKS	PAGE
Fuel	<ul style="list-style-type: none">• Check fuel level in fuel tank.• Refuel if necessary.• Check fuel line for leakage.	3-10
Engine oil	<ul style="list-style-type: none">• Check oil level in engine.• If necessary, add recommended oil to specified level.• Check vehicle for oil leakage.	6-14
Final transmission oil	<ul style="list-style-type: none">• Check vehicle for oil leakage.	6-17
Coolant	<ul style="list-style-type: none">• Check coolant level in reservoir.• If necessary, add recommended coolant to specified level.• Check cooling system for leakage.	6-18
Front brake	<ul style="list-style-type: none">• Check operation.• If soft or spongy, have Yamaha dealer bleed hydraulic system.• Check brake pads for wear.• Replace if necessary.• Check fluid level in reservoir.• If necessary, add recommended brake fluid to specified level.• Check hydraulic system for leakage.	6-26, 6-28
Rear brake	<ul style="list-style-type: none">• Check operation.• If soft or spongy, have Yamaha dealer bleed hydraulic system.• Check brake pads for wear.• Replace if necessary.• Check fluid level in reservoir.• If necessary, add recommended brake fluid to specified level.• Check hydraulic system for leakage.	6-26, 6-28
Throttle grip	<ul style="list-style-type: none">• Make sure that operation is smooth.• Check cable free play.• If necessary, have Yamaha dealer adjust cable free play and lubricate cable and grip housing.	6-23, 6-30

PRE-OPERATION CHECKS

ITEM	CHECKS	PAGE
Wheels and tires	<ul style="list-style-type: none">• Check for damage.• Check tire condition and tread depth.• Check air pressure.• Correct if necessary.	6-23, 6-25
Brake levers	<ul style="list-style-type: none">• Make sure that operation is smooth.• Lubricate lever pivoting points if necessary.	6-30
Centerstand, sidestand	<ul style="list-style-type: none">• Make sure that operation is smooth.• Lubricate pivots if necessary.	6-31
Chassis fasteners	<ul style="list-style-type: none">• Make sure that all nuts, bolts and screws are properly tightened.• Tighten if necessary.	—
Instruments, lights, signals and switches	<ul style="list-style-type: none">• Check operation.• Correct if necessary.	—
Sidestand switch	<ul style="list-style-type: none">• Check operation of ignition circuit cut-off system.• If system is defective, have Yamaha dealer check vehicle.	3-16

OPERATION AND IMPORTANT RIDING POINTS

EAU15980

EWA10870

EAU34460

ECA10250

WARNING

- Become thoroughly familiar with all operating controls and their functions before riding. Consult a Yamaha dealer regarding any control or function that you do not thoroughly understand.
- Never start the engine or operate it in a closed area for any length of time. Exhaust fumes are poisonous, and inhaling them can cause loss of consciousness and death within a short time. Always make sure that there is adequate ventilation.
- For safety, always start the engine with the centerstand down.

Starting the engine

CAUTION:

See page 5-3 for engine break-in instructions prior to operating the vehicle for the first time.

In order for the ignition circuit cut-off system to enable starting, the side-stand must be up.

EWA10290

WARNING

- Before starting the engine, check the function of the ignition circuit cut-off system according to the procedure described on page 3-16.
- Never ride with the sidestand down.

1. Turn the key to “ON” and make sure that the engine stop switch is set to “○”.
2. Close the throttle completely.
3. Start the engine by pushing the start switch while applying the front or rear brake.

NOTE:

If the engine does not start, release the

start switch, wait a few seconds, and then try again. Each starting attempt should be as short as possible to preserve the battery. Do not crank the engine more than 10 seconds on any one attempt.

ECA11040

CAUTION:

For maximum engine life, never accelerate hard when the engine is cold!

OPERATION AND IMPORTANT RIDING POINTS

EAU16760

Starting off

NOTE:

Before starting off, allow the engine to warm up.

1. While pulling the rear brake lever with your left hand and holding the grab bar with your right hand, push the scooter off the centerstand.

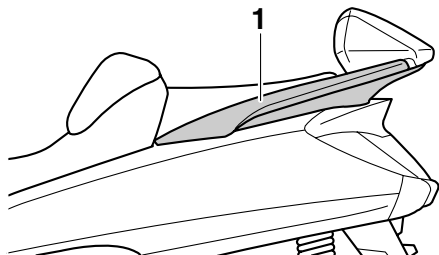

1. Grab bar

2. Sit astride the seat, and then adjust the rear view mirrors.
3. Switch the turn signal on.
4. Check for oncoming traffic, and then slowly turn the throttle grip (on the right) in order to take off.
5. Switch the turn signal off.

EAU16780

Acceleration and deceleration

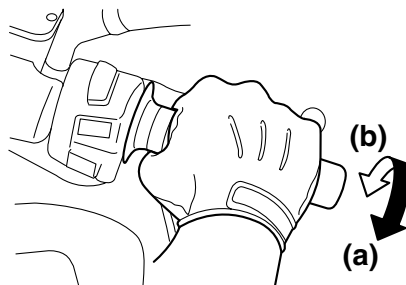

The speed can be adjusted by opening and closing the throttle. To increase the speed, turn the throttle grip in direction (a). To reduce the speed, turn the throttle grip in direction (b).

EAU16792

Braking

1. Close the throttle completely.
2. Apply both front and rear brakes simultaneously while gradually increasing the pressure.

Front

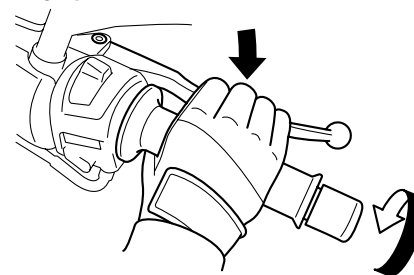

OPERATION AND IMPORTANT RIDING POINTS

Rear

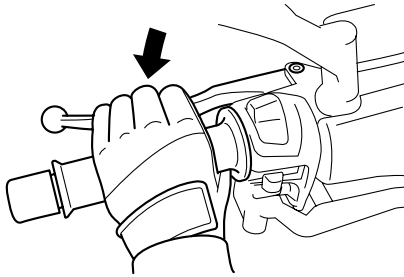

EWA10300

WARNING

- Avoid braking hard or suddenly (especially when leaning over to one side), otherwise the scooter may skid or overturn.
- Railroad crossings, streetcar rails, iron plates on road construction sites, and manhole covers become extremely slippery when wet. Therefore, slow down when approaching such areas and cross them with caution.
- Keep in mind that braking on a wet road is much more difficult.
- Ride slowly down a hill, as braking downhill can be very diffi-

cult.

Engine break-in

EAU16841

There is never a more important period in the life of your engine than the period between 0 and 1600 km (1000 mi). For this reason, you should read the following material carefully.

Since the engine is brand new, do not put an excessive load on it for the first 1600 km (1000 mi). The various parts in the engine wear and polish themselves to the correct operating clearances. During this period, prolonged full-throttle operation or any condition that might result in engine overheating must be avoided.

5

EAU34320

0–1000 km (0–600 mi)

Avoid prolonged operation above 4000 r/min.

1000–1600 km (600–1000 mi)

Avoid prolonged operation above 6000 r/min.

ECA12930

CAUTION:

After 1000 km (600 mi) of operation, be sure to replace the engine oil, fi-

OPERATION AND IMPORTANT RIDING POINTS

nal transmission oil and the oil filter element.

1600 km (1000 mi) and beyond

The vehicle can now be operated normally.

ECA10310

CAUTION:

- Keep the engine speed out of the tachometer red zone.
- If any engine trouble should occur during the engine break-in period, immediately have a Yamaha dealer check the vehicle.

5

EAU17212

Parking

When parking, stop the engine, and then remove the key from the main switch.

EWA10310

WARNING

- Since the engine and exhaust system can become very hot, park in a place where pedestrians or children are not likely to touch them.
- Do not park on a slope or on soft ground, otherwise the vehicle may overturn.

ECA10380

CAUTION:

Never park in an area where there are fire hazards such as grass or other flammable materials.

PERIODIC MAINTENANCE AND MINOR REPAIR

EAU17271

Safety is an obligation of the owner. Periodic inspection, adjustment and lubrication will keep your vehicle in the safest and most efficient condition possible. The most important points of scooter inspection, adjustment, and lubrication are explained on the following pages.

Maintenance, replacement, or repair of the emission control devices and systems may be performed by any repair establishment or individual that is certified (if applicable).

EWA10320



If you are not familiar with maintenance work, have a Yamaha dealer do it for you.

EWA10330



This scooter is designed for use on paved roads only. If this scooter is operated in abnormally dusty, muddy or wet conditions, the air filter element should be cleaned or replaced more frequently, otherwise

rapid engine wear may result. Consult a Yamaha dealer for proper maintenance intervals.

EAU17301

PERIODIC MAINTENANCE

PROPER PERIODIC MAINTENANCE OF YOUR VEHICLE IS IMPORTANT IN ORDER TO ENJOY LONG, PLEASURABLE SERVICE. ESPECIALLY IMPORTANT ARE THE MAINTENANCE SERVICES RELATED TO EMISSIONS CONTROL. THESE CONTROLS NOT ONLY FUNCTION TO ENSURE CLEANER AIR, BUT ARE ALSO VITAL TO PROPER ENGINE OPERATION AND MAXIMUM PERFORMANCE. IN THE FOLLOWING PERIODIC MAINTENANCE CHARTS, THE SERVICES RELATED TO EMISSIONS CONTROL ARE GROUPED SEPARATELY. THESE SERVICES REQUIRE SPECIALIZED DATA, KNOWLEDGE, AND EQUIPMENT. YAMAHA DEALERS ARE TRAINED AND EQUIPPED TO PERFORM THESE PARTICULAR SERVICES.

PERIODIC MAINTENANCE AND MINOR REPAIR

EAU17501

Owner's tool kit

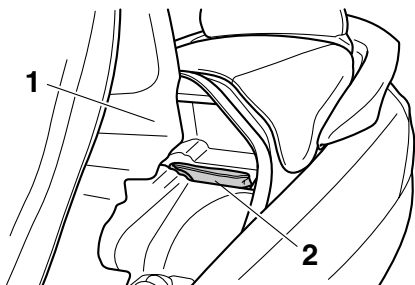

1. Storage compartment mat
2. Owner's tool kit

The owner's tool kit is located inside the rear storage compartment. (See page 3-13.)

Pull up the storage compartment mat, and then remove the owner's tool kit.

The service information included in this manual and the tools provided in the owner's tool kit are intended to assist you in the performance of preventive maintenance and minor repairs. However, additional tools such as a torque wrench may be necessary to perform certain maintenance work correctly.

NOTE: _____

If you do not have the tools or experience required for a particular job, have a Yamaha dealer perform it for you.

EWA10350

WARNING _____

Modifications not approved by Yamaha may cause loss of performance and render the vehicle unsafe for use. Consult a Yamaha dealer before attempting any changes.

PERIODIC MAINTENANCE AND MINOR REPAIR

EAU17600

Periodic maintenance chart for the emission control system

No.	ITEM	ROUTINE	INITIAL	ODOMETER READINGS					
			600 mi (1000 km) or 1 month	4000 mi (7000 km) or 6 months	8000 mi (13000 km) or 12 months	12000 mi (19000 km) or 18 months	16000 mi (25000 km) or 24 months	20000 mi (31000 km) or 30 months	
1	*	Fuel line	<ul style="list-style-type: none"> Check fuel and vacuum hoses for cracks or damage. Replace if necessary. 		✓	✓	✓	✓	✓
2		Spark plug	<ul style="list-style-type: none"> Check condition. Adjust gap and clean. Replace every 10000 mi (16000 km) or 18 months. 		✓	✓	Replace.	✓	✓
3	*	Valve clearance	<ul style="list-style-type: none"> Check and adjust valve clearance when engine is cold. 	Every 26600 mi (42000 km)					
4	*	Crankcase breather system	<ul style="list-style-type: none"> Check breather hose for cracks or damage. Replace if necessary. 		✓	✓	✓	✓	✓
5	*	Fuel injection	<ul style="list-style-type: none"> Check engine idle speed. 	✓	✓	✓	✓	✓	✓
6	*	Evaporative emission control system	<ul style="list-style-type: none"> Check control system for damage. Replace if necessary. 				✓		
7	*	Air induction system	<ul style="list-style-type: none"> Check the air cut-off valve, reed valve, and hose for damage. Replace any damaged parts. 				✓		

* Since these items require special tools, data and technical skills, have a Yamaha dealer perform the service.

PERIODIC MAINTENANCE AND MINOR REPAIR

EAU32185

General maintenance and lubrication chart

No.	ITEM	ROUTINE	INITIAL	ODOMETER READINGS				
			600 mi (1000 km) or 1 month	4000 mi (7000 km) or 6 months	8000 mi (13000 km) or 12 months	12000 mi (19000 km) or 18 months	16000 mi (25000 km) or 24 months	20000 mi (31000 km) or 30 months
1	Air filter elements	<ul style="list-style-type: none"> Replace. 	Every 12000 mi (19000 km)					
2	V-belt case air filter element	<ul style="list-style-type: none"> Clean. 		✓	✓	✓	✓	✓
3	* Front brake	<ul style="list-style-type: none"> Check operation, fluid level, and for fluid leakage. Replace brake pads if necessary. 	✓	✓	✓	✓	✓	✓
4	* Rear brake	<ul style="list-style-type: none"> Check operation, fluid level, and for fluid leakage. Replace brake pads if necessary. 	✓	✓	✓	✓	✓	✓
5	* Brake hoses	<ul style="list-style-type: none"> Check for cracks or damage. Replace. 		✓	✓	✓	✓	✓
			Every 4 years					
6	Rear brake lock	<ul style="list-style-type: none"> Check operation. Adjust. 	✓	✓	✓	✓	✓	✓
7	* Wheels	<ul style="list-style-type: none"> Check runout and for damage. Replace if necessary. 		✓	✓	✓	✓	✓
8	* Tires	<ul style="list-style-type: none"> Check tread depth and for damage. Replace if necessary. Check air pressure. Correct if necessary. 		✓	✓	✓	✓	✓
9	* Wheel bearings	<ul style="list-style-type: none"> Check bearings for smooth operation. Replace if necessary. 		✓	✓	✓	✓	✓

PERIODIC MAINTENANCE AND MINOR REPAIR

No.	ITEM	ROUTINE	INITIAL	ODOMETER READINGS					
			600 mi (1000 km) or 1 month	4000 mi (7000 km) or 6 months	8000 mi (13000 km) or 12 months	12000 mi (19000 km) or 18 months	16000 mi (25000 km) or 24 months	20000 mi (31000 km) or 30 months	
10	* Steering bearings	<ul style="list-style-type: none"> Check bearing assemblies for looseness. 	√	√	√	√	√	√	
		<ul style="list-style-type: none"> Moderately repack with lithium-soap-based grease. 	Every 12000 mi (19000 km)						
11	* Chassis fasteners	<ul style="list-style-type: none"> Check all chassis fitting and fasteners. Correct if necessary. 		√	√	√	√	√	
12	Front brake lever pivot shaft	<ul style="list-style-type: none"> Apply silicone grease lightly. 		√	√	√	√	√	
13	Rear brake lever pivot shaft	<ul style="list-style-type: none"> Apply silicone grease lightly. 		√	√	√	√	√	
14	Centerstand and sidestand pivots	<ul style="list-style-type: none"> Check operation. Apply lithium-soap-based grease (all-purpose grease) lightly. 		√	√	√	√	√	
15	* Sidestand switch	<ul style="list-style-type: none"> Check operation and replace if necessary. 	√	√	√	√	√	√	
16	* Front fork	<ul style="list-style-type: none"> Check operation and for oil leakage. Replace if necessary. 		√	√	√	√	√	
17	* Shock absorber assemblies	<ul style="list-style-type: none"> Check operation and for oil leakage. Replace if necessary. 		√	√	√	√	√	
18	Engine oil	<ul style="list-style-type: none"> Change. (See pages 3-3 and 6-14.) 	√	When the oil change indicator flashes (every 3125 mi (5000 km))					
		<ul style="list-style-type: none"> Check oil level and vehicle for oil leakage. 	Every 3125 mi (5000 km)						

PERIODIC MAINTENANCE AND MINOR REPAIR

No.	ITEM	ROUTINE	INITIAL	ODOMETER READINGS				
			600 mi (1000 km) or 1 month	4000 mi (7000 km) or 6 months	8000 mi (13000 km) or 12 months	12000 mi (19000 km) or 18 months	16000 mi (25000 km) or 24 months	20000 mi (31000 km) or 30 months
19	Engine oil filter element	<ul style="list-style-type: none"> Replace. 	√	Every 12500 mi (20000 km)				
20	* Cooling system	<ul style="list-style-type: none"> Check coolant level and vehicle for coolant leakage. Change. 		√	√	√	√	√
21	Final transmission oil	<ul style="list-style-type: none"> Check vehicle for oil leakage. Change. 	√		√		√	
22	* V-belt	<ul style="list-style-type: none"> Replace. 	When the V-belt replacement indicator flashes (every 12500 mi (20000 km)).					
23	* Front and rear brake switches	<ul style="list-style-type: none"> Check operation. 	√	√	√	√	√	√
24	* Throttle grip housing and cable	<ul style="list-style-type: none"> Check operation and free play. Adjust the throttle cable free play if necessary. Lubricate the throttle grip housing and cable. 		√	√	√	√	√
25	* Lights, signals and switches	<ul style="list-style-type: none"> Check operation. Adjust headlight beam. 	√	√	√	√	√	√

* Since these items require special tools, data and technical skills, have a Yamaha dealer perform the service.

NOTE:

From 24000 mi (37000 km) or 36 months, repeat the maintenance intervals starting from 8000 mi (13000 km) or 12 months.

PERIODIC MAINTENANCE AND MINOR REPAIR

EAU36370

NOTE: _____

- The air filters and V-belt filter need more frequent service if you are riding in unusually wet or dusty areas.
 - Hydraulic brake service
 - After disassembling the brake master cylinders and calipers, always change the fluid. Regularly check the brake fluid levels and fill the reservoirs as required.
 - Every two years replace the internal components of the brake master cylinders and calipers, and change the brake fluid.
 - Replace the brake hoses every four years and if cracked or damaged.
-

PERIODIC MAINTENANCE AND MINOR REPAIR

EAU18712

Removing and installing cowlings and panels

The cowlings and panels shown need to be removed to perform some of the maintenance jobs described in this chapter. Refer to this section each time a cowling or panel needs to be removed and installed.

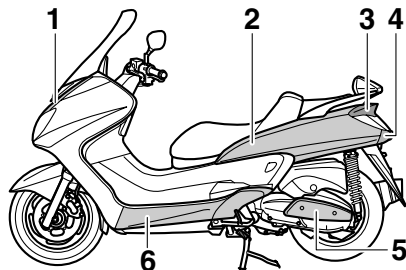

1. Panel A
2. Cowling C
3. Cowling A
4. Cowling B
5. Panel B
6. Cowling E

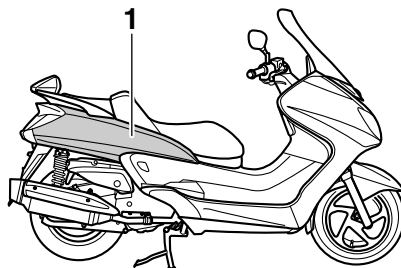

1. Cowling D

Cowling A

To remove the cowling

1. Open the rider seat. (See page 3-11.)
2. Remove the quick fasteners in the rear storage compartment, and then pull the cowling off as shown.

NOTE:

The quick fastener is removed by pushing the center pin in with a screwdriver, and then pulling the fastener out.

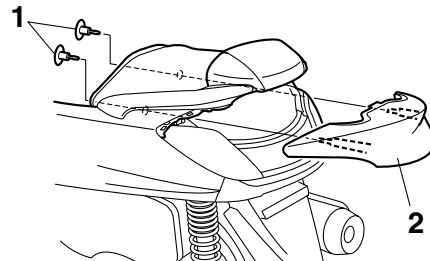

1. Quick fastener
2. Cowling A

To install the cowling

1. Place the cowling in the original position, and then install the quick fasteners.

NOTE:

To install the quick fastener, push the center pin out so that it will protrude from the fastener head, insert the fastener into the cowling, and then push the protruding pin in until it is flush with the fastener head.

2. Close the rider seat.

EAU34282

PERIODIC MAINTENANCE AND MINOR REPAIR

Cowling B

To remove the cowling

1. Remove the screws.

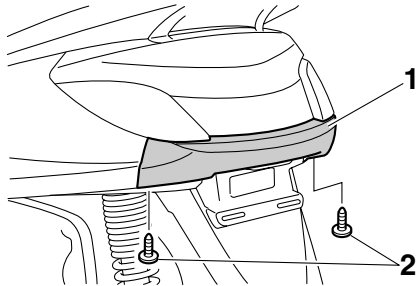

1. Cowling B
2. Screw

2. Remove the cowling as shown.

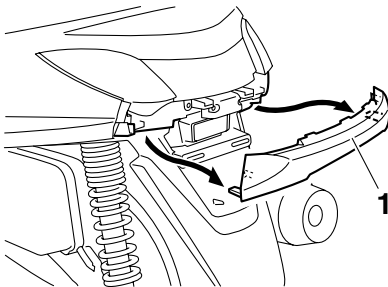

1. Cowling B

To install the cowling

Place the cowling in the original position, and then install the screws.

Cowlings C and D

To remove one of the cowlings

1. Remove cowlings A and B.
2. Remove the passenger seat. (See page 3-11.)
3. Remove the grab bar by removing the grab bar bolts and collars.

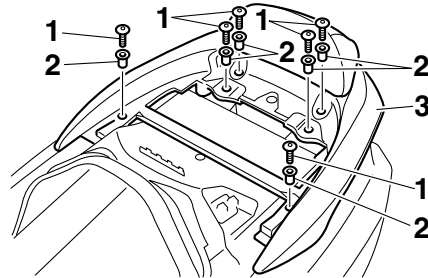

1. Grab bar bolt
2. Collar
3. Grab bar

4. Remove the screw access cover by pulling it off.

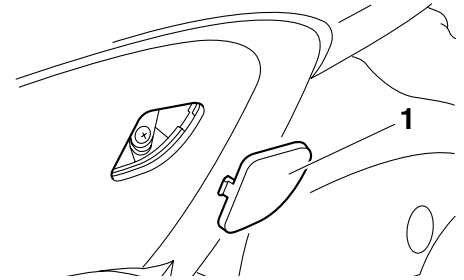

1. Screw access cover

5. Remove the screws, and then pull the cowling off.

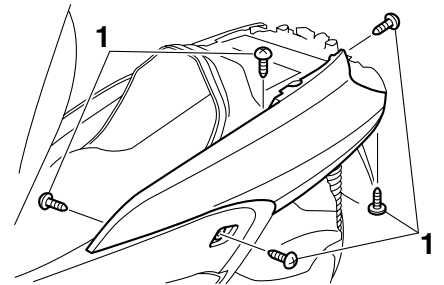

1. Screw

To install the cowling

1. Place the cowling in the original position, and then install the screws.

PERIODIC MAINTENANCE AND MINOR REPAIR

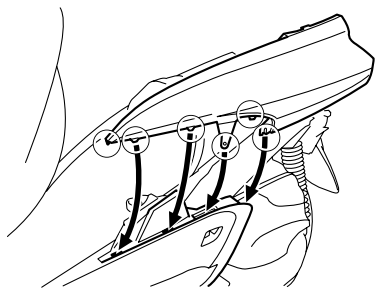

2. Install the screw access cover by placing it in its original position.
3. Install the grab bar by installing the collars and grab bar bolts.

Tightening torque:

Grab bar bolt:
23 Nm (2.3 m·kgf, 16.6 ft·lbf)

4. Install the passenger seat.
5. Install cowlings A and B.

Cowling E

To remove the cowling

1. Pull up the left floorboard mats as shown.

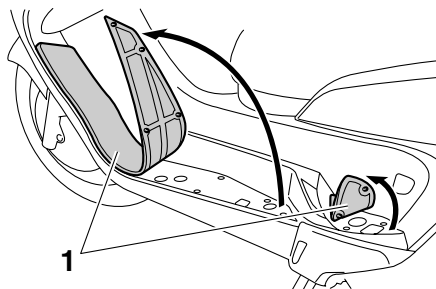

1. Left floorboard mat
2. Remove the cowling screws.

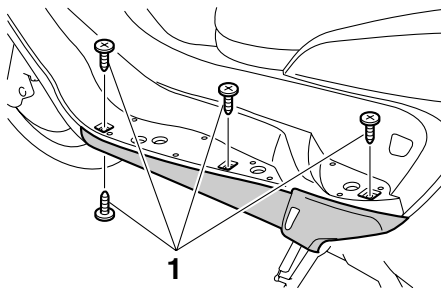

1. Screw
3. Pull the cowling down slightly, and then pull it outward as shown.

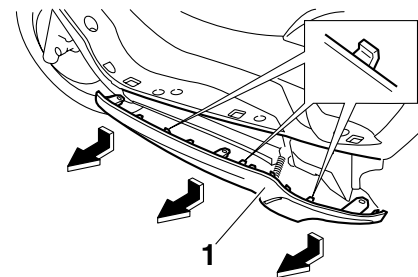

1. Cowling E

To install the cowling

1. Insert the projections on the cowling into the slots as shown, and then install the screws.

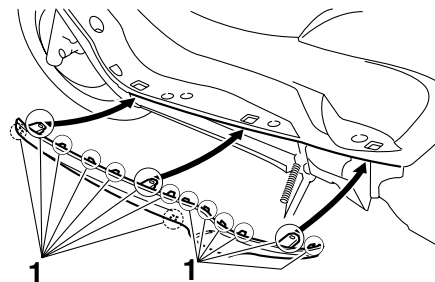

1. Projection

2. Place the left floorboard mats in the original position.

PERIODIC MAINTENANCE AND MINOR REPAIR

EAU34290

Panel A

To remove the panel

1. Remove the bolts.

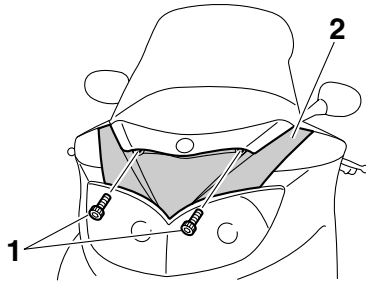

1. Bolt
2. Panel A

2. Pull the panel out as shown.

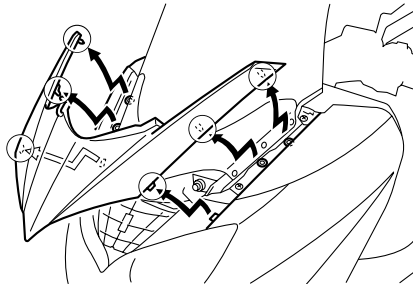

To install the panel

Place the panel in the original position, and then install the bolts.

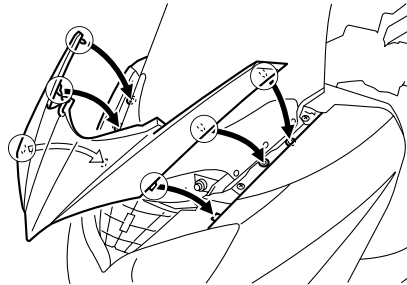

Panel B

To remove the panel

Remove the screws, and then pull the panel outward.

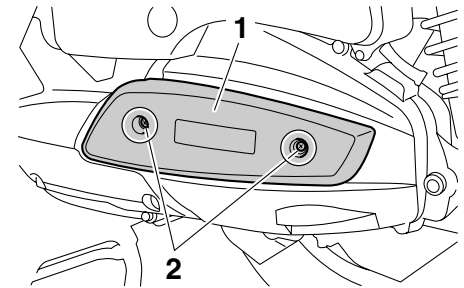

1. Panel B
2. Screw

To install the panel

Place the panel in the original position, and then install the screws.

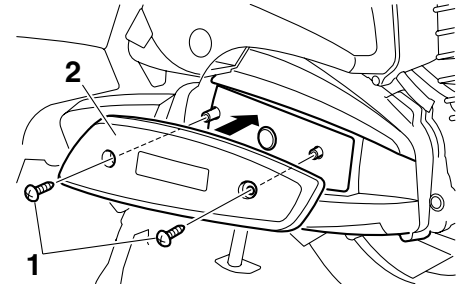

1. Screw
2. Panel B

PERIODIC MAINTENANCE AND MINOR REPAIR

EAU34172

Checking the spark plug

The spark plug is an important engine component, which is easy to check. Since heat and deposits will cause any spark plug to slowly erode, the spark plug should be removed and checked in accordance with the periodic maintenance and lubrication chart. In addition, the condition of the spark plug can reveal the condition of the engine.

To remove the spark plug

1. Open the rider seat. (See page 3-11.)
2. Pull up the storage compartment mat, and then remove the spark plug cover by removing the screws.

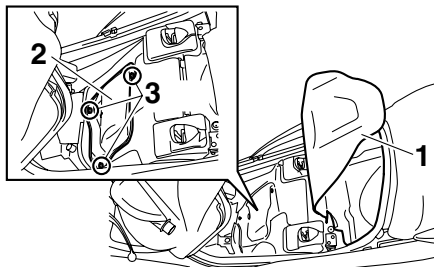

1. Storage compartment mat
2. Spark plug cover
3. Screw

3. Remove the spark plug cap.

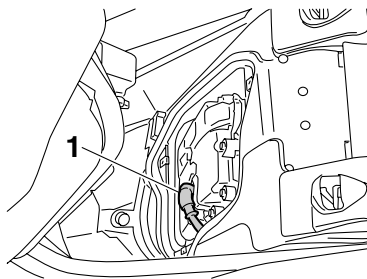

1. Spark plug cap

4. Remove the spark plug as shown, with the spark plug wrench included in the owner's tool kit.

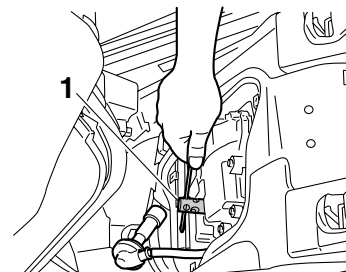

1. Spark plug wrench

To check the spark plug

1. Check that the porcelain insulator around the center electrode of the spark plug is a medium-to-light tan (the ideal color when the vehicle is ridden normally).

NOTE:

If the spark plug shows a distinctly different color, the engine could be operating improperly. Do not attempt to diagnose such problems yourself. Instead, have a Yamaha dealer check the vehicle.

2. Check the spark plug for electrode erosion and excessive carbon or other deposits, and replace it if

PERIODIC MAINTENANCE AND MINOR REPAIR

necessary.

Specified spark plug:
NGK/CR7E

To install the spark plug

1. Measure the spark plug gap with a wire thickness gauge and, if necessary, adjust the gap to specification.

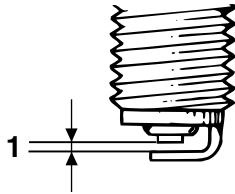

1. Spark plug gap

Spark plug gap:
0.7–0.8 mm (0.028–0.031 in)

2. Clean the surface of the spark plug gasket and its mating surface, and then wipe off any grime from the spark plug threads.

3. Install the spark plug with the spark plug wrench, and then tighten it to the specified torque.

Tightening torque:

Spark plug:
12.5 Nm (1.25 m·kgf, 9 ft·lbf)

NOTE: _____
If a torque wrench is not available when installing a spark plug, a good estimate of the correct torque is 1/4–1/2 turn past finger tight. However, the spark plug should be tightened to the specified torque as soon as possible.

4. Install the spark plug cap.

NOTE: _____
Make sure the spark plug wire is fastened in the clamp as shown.

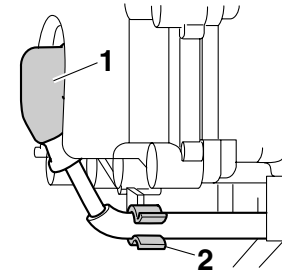

1. Spark plug cap
2. Spark plug wire clamp

5. Install the spark plug cover by installing the screws.
6. Place the storage compartment mat in the original position.
7. Close the rider seat.

PERIODIC MAINTENANCE AND MINOR REPAIR

EAU36110

Canister

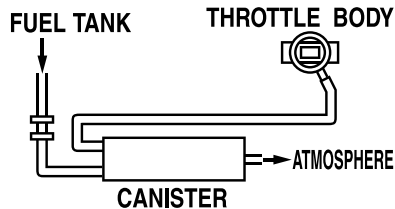

This model is equipped with a canister to prevent the discharging of fuel vapor into the atmosphere. Before operating this vehicle, make sure to check the following:

- Check each hose connection.
- Check each hose and canister for cracks or damage. Replace if damaged.
- Make sure that the canister breather is not blocked, and if necessary, clean it.

Engine oil and oil filter element

The engine oil level should be checked before each ride. In addition, the oil must be changed and the oil filter element replaced at the intervals specified in the periodic maintenance and lubrication chart and when the oil change indicator comes on.

To check the engine oil level

1. Place the vehicle on the center-stand.

NOTE:

Make sure that the vehicle is positioned straight up when checking the oil level. A slight tilt to the side can result in a false reading.

2. Start the engine, warm it up for several minutes, and then turn it off.
3. Wait a few minutes until the oil settles, remove the oil filler cap, wipe the dipstick clean, insert it back into the oil filler hole (without screwing it in), and then remove it again to check the oil level.

EAU34182

NOTE: _____
The engine oil should be between the minimum and maximum level marks.

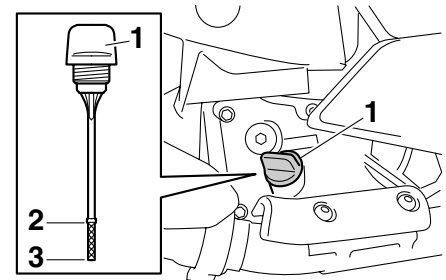

1. Engine oil filler cap
2. Maximum level mark
3. Minimum level mark
4. If the engine oil is below the minimum level mark, add sufficient oil of the recommended type to raise it to the correct level.
5. Insert the dipstick into the oil filler hole, and then tighten the oil filler cap.

PERIODIC MAINTENANCE AND MINOR REPAIR

To change the engine oil (with or without oil filter element replacement)

1. Start the engine, warm it up for several minutes, and then turn it off.
2. Place an oil pan under the engine to collect the used oil.
3. Remove the engine oil filler cap and the engine oil drain bolt to drain the oil from the crankcase.

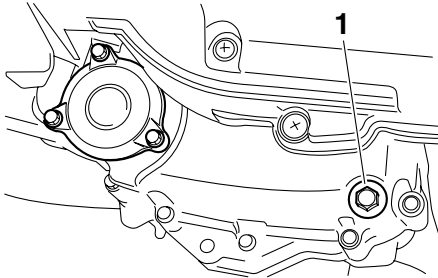

1. Engine oil drain bolt

4. Check the washer for damage and replace it if necessary.

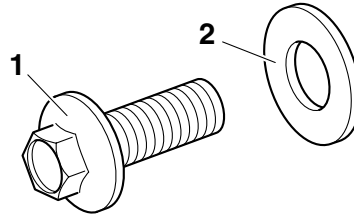

1. Engine oil drain bolt
2. Washer

NOTE: _____
Skip steps 5–7 if the oil filter element is not being replaced.

5. Remove the oil filter element cover by removing the bolts.

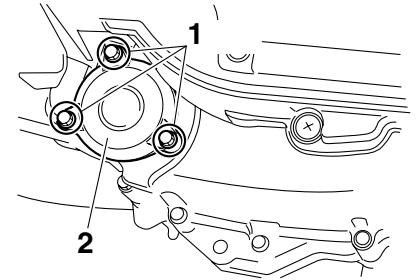

1. Bolt
2. Oil filter element cover

6. Remove and replace the oil filter element and O-rings.

PERIODIC MAINTENANCE AND MINOR REPAIR

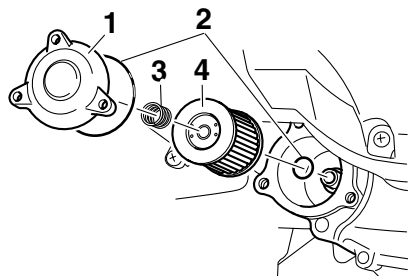

1. Oil filter element cover
2. O-ring
3. Compression spring
4. Oil filter element

ECA12910

CAUTION:

When removing the oil filter element cover, the compression spring will fall out. Take care not to lose the compression spring.

7. Install the compression spring and oil filter element cover by installing the bolts, then tightening them to the specified torque.

Tightening torque:

Oil filter element cover bolt:
10 Nm (1.0 m·kgf, 7.2 ft·lbf)

NOTE:

Make sure that the O-rings are properly seated.

8. Install the washer and the engine oil drain bolt, and then tighten the drain bolt to the specified torque.

Tightening torque:

Engine oil drain bolt:
20 Nm (2.0 m·kgf, 14.5 ft·lbf)

NOTE:

Make sure that the washer is properly seated.

9. Add the specified amount of the recommended engine oil, and then install and tighten the oil filler cap.

Recommended engine oil:

See page 8-1.

Oil quantity:

Without oil filter element replacement:

1.50 L (1.59 US qt) (1.32 Imp.qt)

With oil filter element replacement:

1.70 L (1.80 US qt) (1.50 Imp.qt)

NOTE:

Be sure to wipe off spilled oil on any parts after the engine and exhaust system have cooled down.

ECA11670

CAUTION:

- Do not use oils with a diesel specification of "CD" or oils of a higher quality than specified. In addition, do not use oils labeled "ENERGY CONSERVING II" or higher.
- Be sure no foreign material enters the crankcase.

10. Start the engine, and then let it idle for several minutes while checking it for oil leakage. If oil is leaking, immediately turn the engine off and check for the cause.

PERIODIC MAINTENANCE AND MINOR REPAIR

EAU20061

11. Reset the oil change indicator according to the following procedure.

To reset the oil change indicator

1. Turn the key to "ON".
2. Hold the "OIL CHANGE" button pushed for two to eight seconds.

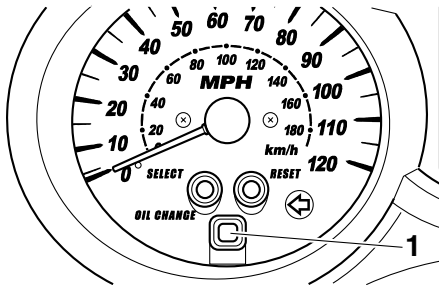

1. "OIL CHANGE" button

3. Release the "OIL CHANGE" button, and the oil change indicator will go off.

NOTE:

If the engine oil is changed before the oil change indicator comes on (i.e. before the periodic oil change interval has been reached), the indicator must be reset after the oil change for the next periodic oil change to be indicated at

the correct time. To reset the oil change indicator before the periodic oil change interval has been reached, follow the above procedure, but note that the indicator will come on for 1.4 seconds after releasing the "OIL CHANGE" button, otherwise repeat the procedure.

Final transmission oil

The final transmission case must be checked for oil leakage before each ride. If any leakage is found, have a Yamaha dealer check and repair the scooter. In addition, the final transmission oil must be changed as follows at the intervals specified in the periodic maintenance and lubrication chart.

1. Start the engine, warm up the final transmission oil by riding the scooter for several minutes, and then stop the engine.
2. Place the scooter on the center-stand.
3. Place an oil pan under the final transmission case to collect the used oil.
4. Remove the oil filler cap and drain bolt to drain the oil from the final transmission case.

PERIODIC MAINTENANCE AND MINOR REPAIR

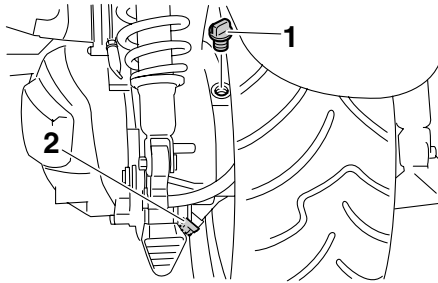

1. Final transmission oil filler cap
2. Final transmission oil drain bolt

5. Install the final transmission oil drain bolt, and then tighten it to the specified torque.

6

Tightening torque:

Final transmission oil drain bolt:
20 Nm (2.0 m·kgf, 14.5 ft·lbf)

6. Add the specified amount of the recommended final transmission oil, and then install and tighten the oil filler cap.

Recommended final transmission oil:

See page 8-1.

Oil quantity:

0.25 L (0.26 US qt) (0.22 Imp.qt)

EWA11310

WARNING

- Make sure that no foreign material enters the final transmission case.
- Make sure that no oil gets on the tire or wheel.

7. Check the final transmission case for oil leakage. If oil is leaking, check for the cause.

EAU20070

Coolant

The coolant level should be checked before each ride. In addition, the coolant must be changed at the intervals specified in the periodic maintenance and lubrication chart.

EAU34192

To check the coolant level

1. Place the vehicle on a level surface and hold it in an upright position.

NOTE:

- The coolant level must be checked on a cold engine since the level varies with engine temperature.
- Make sure that the vehicle is positioned straight up when checking the coolant level. A slight tilt to the side can result in a false reading.

2. Pull up the right floorboard mat as shown.

PERIODIC MAINTENANCE AND MINOR REPAIR

ECA10471

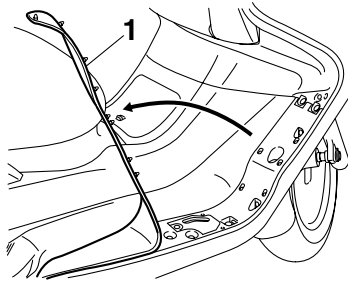

1. Right floorboard mat

3. Remove the coolant reservoir cover by removing the screw.

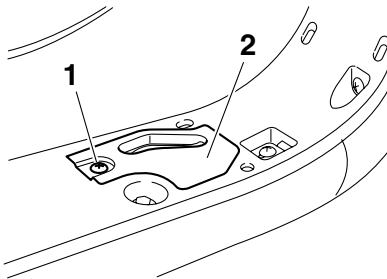

1. Screw

2. Coolant reservoir cover

4. Check the coolant level in the coolant reservoir.

NOTE: _____
The coolant should be between the minimum and maximum level marks.

5. If the coolant is at or below the minimum level mark, open the coolant reservoir cap, add coolant to the maximum level mark, and then close the coolant reservoir cap.

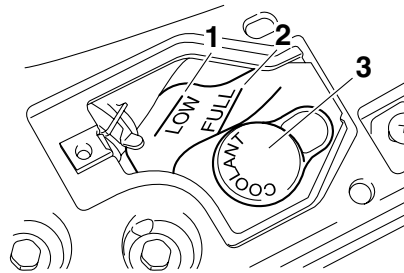

1. Minimum level mark

2. Maximum level mark

3. Coolant reservoir cap

Coolant reservoir capacity (up to the maximum level mark):

0.32 L (0.34 US qt) (0.28 Imp.qt)

CAUTION: _____

- If coolant is not available, use distilled water or soft tap water instead. Do not use hard water or salt water since it is harmful to the engine.
- If water has been used instead of coolant, replace it with coolant as soon as possible, otherwise the cooling system will not be protected against frost and corrosion.
- If water has been added to the coolant, have a Yamaha dealer check the antifreeze content of the coolant as soon as possible, otherwise the effectiveness of the coolant will be reduced.

6

EWA10380

⚠ WARNING _____

Never attempt to remove the radiator cap when the engine is hot.

6. Install the coolant reservoir cover by installing the screw.
7. Place the right floorboard mat in the original position.

PERIODIC MAINTENANCE AND MINOR REPAIR

EAU34204

NOTE: _____

- The radiator fan is automatically switched on or off according to the coolant temperature in the radiator.
- If the engine overheats, see page 6-40 for further instructions.

Air filter elements and check hoses and V-belt case air filter element

The air filter elements and the V-belt case air filter element should be serviced at the intervals specified in the periodic maintenance and lubrication chart. Service all air filter elements more frequently if you are riding in unusually wet or dusty areas.

Replacing the air filter elements

1. Place the scooter on the center-stand.

NOTE: _____

Continue as follows for each air filter element.

2. Remove the air filter case cover by removing the rubber cap and screws.

Left

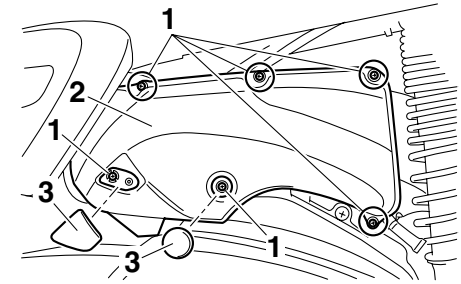

1. Screw
2. Air filter case cover
3. Rubber cap

Right

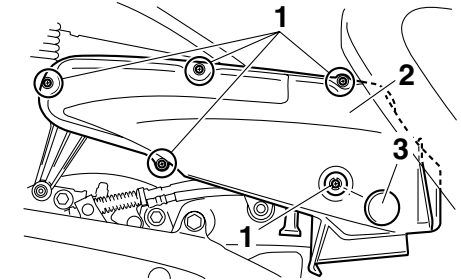

1. Screw
2. Air filter case cover
3. Rubber cap

3. Pull the air filter element out.

PERIODIC MAINTENANCE AND MINOR REPAIR

Left

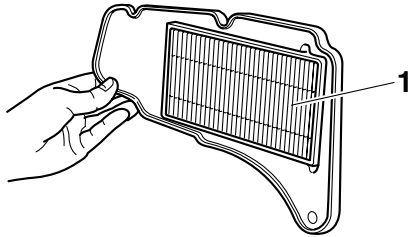

1. Air filter element

Right

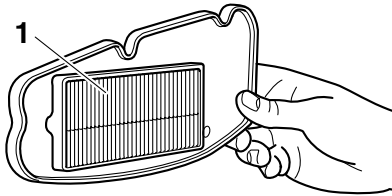

1. Air filter element

4. Insert a new air filter element into the air filter case.
5. Install the air filter case cover by installing the screws.

6. Install the rubber cap.

ECA12922

CAUTION:

- Make sure that each filter element is properly seated in its case.
- Always replace both air filter elements at the same time, otherwise poor engine performance or damage to the engine may result.
- The engine should never be operated without the filter elements installed, otherwise the piston(s) and/or cylinder(s) may become excessively worn.

To clean the air filter check hoses

1. Check the hose at the bottom of both air filter cases for accumulated dirt or water.

Left

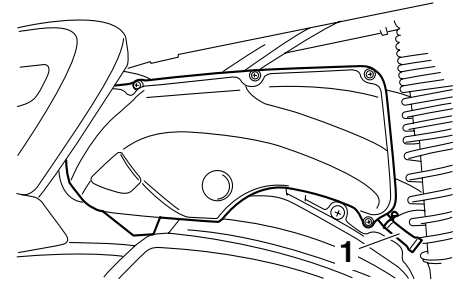

1. Air filter check hose

Right

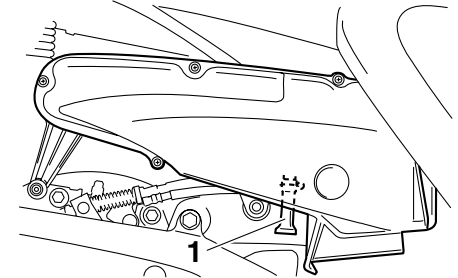

1. Air filter check hose

2. If dirt or water is visible, remove the hose, clean it, and then install it.

PERIODIC MAINTENANCE AND MINOR REPAIR

Cleaning the V-belt case air filter element

1. Remove cowling E. (See page 6-8.)
2. Remove panel B. (See page 6-8.)
3. Remove the left air filter case cover.
4. Remove the V-belt air filter case cover by removing the screws.

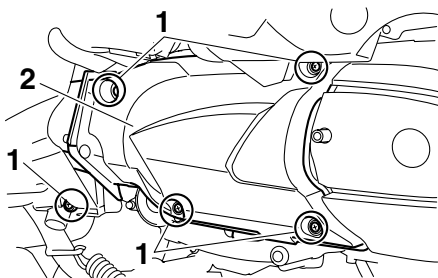

1. Screw
2. V-belt air filter case cover

5. Remove the V-belt case air filter element by removing the screws.

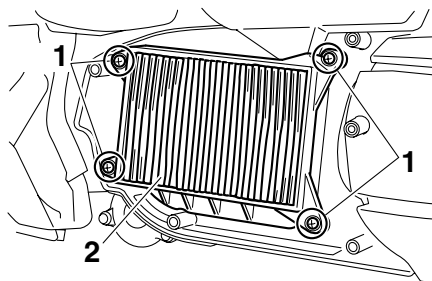

1. Screw
2. V-belt case air filter element

6. Lightly tap the V-belt case air filter element to remove most of the dust and dirt, and then blow out the dirt with compressed air as shown.

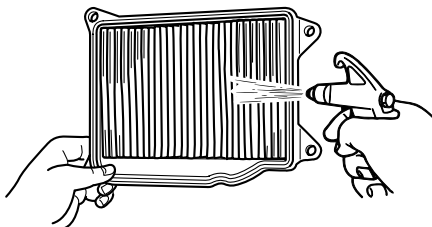

7. Check the V-belt case air filter element for damage and replace it if

necessary.

8. Install the V-belt case air filter element by installing the screws.
9. Install the V-belt air filter case cover by installing the screws.

ECA12940

CAUTION:

Make sure that the V-belt filter element is properly seated in its case.

10. Install the left air filter case cover.
11. Install the panel.
12. Install the cowling.

EAU21382

Checking the throttle cable free play

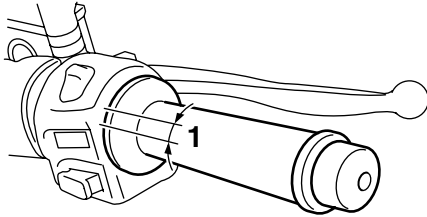

1. Throttle cable free play

The throttle cable free play should measure 3.0–5.0 mm (0.12–0.20 in) at the throttle grip. Periodically check the throttle cable free play and, if necessary, have a Yamaha dealer adjust it.

EAU21401

Valve clearance

The valve clearance changes with use, resulting in improper air-fuel mixture and/or engine noise. To prevent this from occurring, the valve clearance must be adjusted by a Yamaha dealer at the intervals specified in the periodic maintenance and lubrication chart.

EAU21861

Tires

To maximize the performance, durability, and safe operation of your scooter, note the following points regarding the specified tires.

Tire air pressure

The tire air pressure should be checked and, if necessary, adjusted before each ride.

EWA10500

WARNING

- The tire air pressure must be checked and adjusted on cold tires (i.e., when the temperature of the tires equals the ambient temperature).
- The tire air pressure must be adjusted in accordance with the riding speed and with the total weight of rider, passenger, cargo, and accessories approved for this model.

PERIODIC MAINTENANCE AND MINOR REPAIR

Tire air pressure (measured on cold tires):

0–90 kg (0–198 lb):

Front:

200 kPa (29 psi) (2.00 kgf/cm²)

Rear:

250 kPa (36 psi) (2.50 kgf/cm²)

90–196 kg (198–432 lb):

Front:

200 kPa (29 psi) (2.00 kgf/cm²)

Rear:

250 kPa (36 psi) (2.50 kgf/cm²)

Maximum load*:

196 kg (432 lb)

* Total weight of rider, passenger, cargo and accessories

EWA10510

6

⚠ WARNING

Proper loading of your vehicle is important for several characteristics of your vehicle, such as handling, braking, performance and safety. Do not carry loosely packed items that can shift. Securely pack your heaviest items close to the center of the vehicle, and distribute the weight evenly from side to side. Properly adjust the suspension for your load, and check the condition and pressure of your tires. **NEVER OVER-**

LOAD YOUR VEHICLE. Make sure that the total weight of the cargo, rider, passenger, and accessories (cowling, saddlebags, etc. if approved for this model) does not exceed the maximum load of the vehicle. Operation of an overloaded vehicle could cause tire damage, an accident, or even injury.

Tire inspection

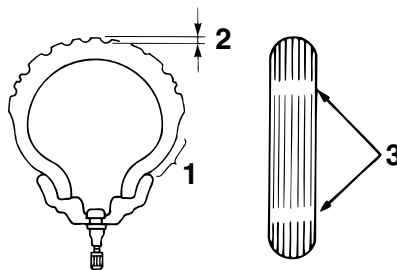

1. Tire sidewall
2. Tire tread depth
3. Tire wear indicator

The tires must be checked before each ride. If a tire tread shows crosswise lines (minimum tread depth), if the tire has a nail or glass fragments in it, or if

the sidewall is cracked, have a Yamaha dealer replace the tire immediately.

Minimum tire tread depth (front and rear):
1.0 mm (0.04 in)

NOTE:

The tire tread depth limits may differ from country to country. Always comply with the local regulations.

Tire information

This scooter is equipped with cast wheels and tubeless tires with valves.

EWA10590

⚠ WARNING

Operating the scooter with excessively worn tires decrease riding stability and can lead to loss of control. Have excessively worn tires replaced by a Yamaha dealer immediately. Brakes, tires, and related wheel parts replacement should be left to a Yamaha Service Technician.

PERIODIC MAINTENANCE AND MINOR REPAIR

EAU21992

Front tire:

Size:

120/80-14M/C 58S

Manufacturer/model:

IRC/MB67

DUNLOP/D305FL

Rear tire:

Size:

150/70-13M/C 64S

Manufacturer/model:

IRC/MB67

DUNLOP/D305L

EWA10580

WARNING

- It is dangerous to ride with a worn-out tire. When a tire tread begins to show crosswise lines, have a Yamaha dealer replace the tire immediately.
- The replacement of all wheel- and brake-related parts, including the tires, should be left to a Yamaha dealer, who has the necessary professional knowledge and experience.

Cast wheels

To maximize the performance, durability, and safe operation of your vehicle, note the following points regarding the specified wheels.

- The wheel rims should be checked for cracks, bends, warpage or damage before each ride. If any damage is found, have a Yamaha dealer replace the wheel. Do not attempt even the smallest repair to the wheel. A deformed or cracked wheel must be replaced.
- The wheel should be balanced whenever either the tire or wheel has been changed or replaced. An unbalanced wheel can result in poor performance, adverse handling characteristics, and a shortened tire life.
- Ride at moderate speeds after changing a tire since the tire surface must first be “broken in” for it to develop its optimal characteristics.
- After repairing or replacing the rear tire, tighten the valve stem nut and locknut to the specified torques.

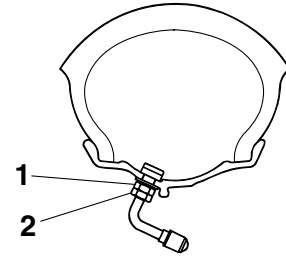

1. Valve stem nut
2. Valve stem locknut

Tightening torques:

Valve stem nut:

1.5 Nm (0.2 m·kgf, 1.1 ft·lbf)

Valve stem locknut:

3.0 Nm (0.3 m·kgf, 2.2 ft·lbf)

PERIODIC MAINTENANCE AND MINOR REPAIR

Accessories and replacement parts

EAU22011

been approved by Yamaha.

EAU33453

WARNING

EWA10621

This vehicle is not designed to pull a trailer or to be attached to a sidecar. The accessories or replacement parts you choose for your vehicle should be designed specifically for this model, and they must be securely mounted to maintain the inherent stability of the original design. Genuine Yamaha Parts and Accessories are designed and tested to be compatible with your vehicle. Please consider Genuine Yamaha Parts and Accessories before making a purchase. Use of non-Yamaha-approved accessories or replacement parts may cause loss of handling stability and riding safety. Since Yamaha cannot control the quality of accessories or parts manufactured by other companies, Yamaha cannot be held liable for any consequences caused by the use of items which have not

Front and rear brake lever free play

Front

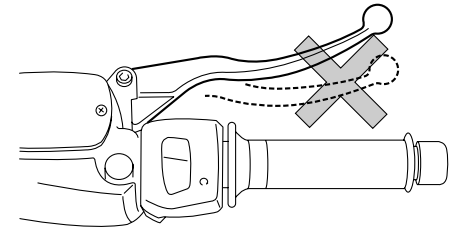

Rear

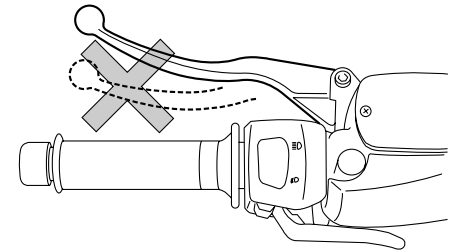

There should be no free play at the brake lever ends. If there is free play, have a Yamaha dealer inspect the

PERIODIC MAINTENANCE AND MINOR REPAIR

brake system.

EWA14211

WARNING

A soft or spongy feeling in the brake lever can indicate the presence of air in the hydraulic system. If there is air in the hydraulic system, have a Yamaha dealer bleed the system before operating the vehicle. Air in the hydraulic system will diminish the braking performance, which may result in loss of control and an accident.

Adjusting the rear brake lock lever cable

EAU33473

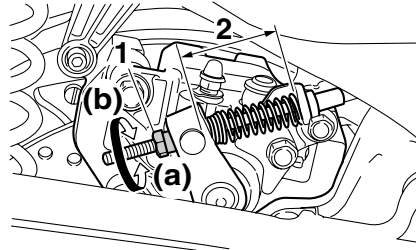

1. Adjusting nut
2. Rear brake lock lever cable length

Rear brake lock lever cable adjustment may be required if the rear brake lock lever does not hold properly. When the rear brake lock lever is not in use, the rear brake lock lever cable length should measure 45 mm to 47 mm (1.77 in to 1.85 in) at the rear brake caliper. Periodically check the rear brake lock lever cable length and, if necessary, adjust it as follows.

To increase the rear brake lock lever cable length, turn the adjusting nut at the rear brake caliper in direction (a).

To decrease the rear brake lock lever cable length, turn the adjusting nut in direction (b).

EWA10650

WARNING

If proper adjustment cannot be obtained as described, have a Yamaha dealer make this adjustment.

PERIODIC MAINTENANCE AND MINOR REPAIR

Checking the front and rear brake pads

The front and rear brake pads must be checked for wear at the intervals specified in the periodic maintenance and lubrication chart.

EAU22390

indicator groove has almost disappeared, have a Yamaha dealer replace the brake pads as a set.

Front brake pads

EAU22420

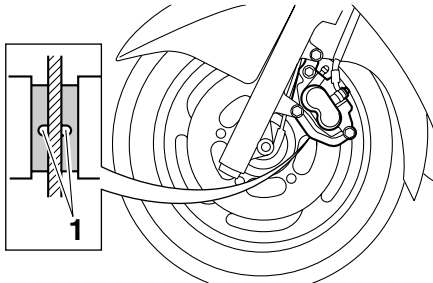

1. Wear indicator groove

Each front brake pad is provided with a wear indicator groove, which allows you to check the brake pad wear without having to disassemble the brake. To check the brake pad wear, check the wear indicator groove. If a brake pad has worn to the point that the wear

Rear brake pads

EAU34210

Have a Yamaha dealer check each rear brake pad for damage and measure the lining thickness and if necessary, replace them as a set.

Checking the brake fluid level

EAU22580

Front brake

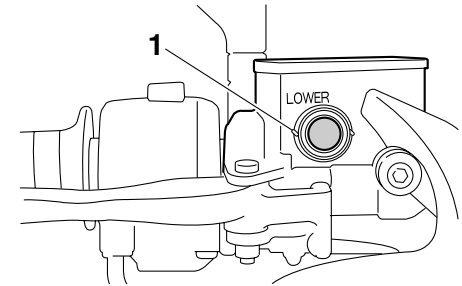

1. Minimum level mark

Rear brake

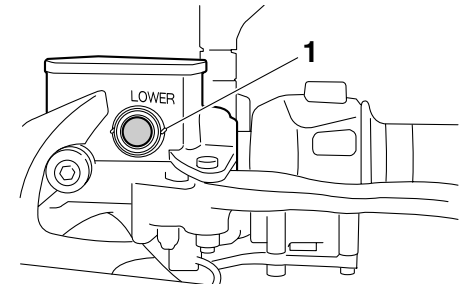

1. Minimum level mark

Insufficient brake fluid may allow air to

PERIODIC MAINTENANCE AND MINOR REPAIR

EAUJ22730

enter the brake system, possibly causing it to become ineffective.

Before riding, check that the brake fluid is above the minimum level mark and replenish if necessary. A low brake fluid level may indicate worn brake pads and/or brake system leakage. If the brake fluid level is low, be sure to check the brake pads for wear and the brake system for leakage.

Observe these precautions:

- When checking the fluid level, make sure that the top of the brake fluid reservoir is level.
- Use only the recommended quality brake fluid, otherwise the rubber seals may deteriorate, causing leakage and poor braking performance.

Recommended brake fluid:

DOT 4

- Refill with the same type of brake fluid. Mixing fluids may result in a harmful chemical reaction and lead to poor braking performance.
- Be careful that water does not enter the brake fluid reservoir when

refilling. Water will significantly lower the boiling point of the fluid and may result in vapor lock.

- Brake fluid may deteriorate painted surfaces or plastic parts. Always clean up spilled fluid immediately.
- As the brake pads wear, it is normal for the brake fluid level to gradually go down. However, if the brake fluid level goes down suddenly, have a Yamaha dealer check the cause.

Changing the brake fluid

Have a Yamaha dealer change the brake fluid at the intervals specified in the NOTE after the periodic maintenance and lubrication chart. In addition, have the oil seals of the master cylinders and calipers as well as the brake hoses replaced at the intervals listed below or whenever they are damaged or leaking.

- Oil seals: Replace every two years.
- Brake hoses: Replace every four years.

PERIODIC MAINTENANCE AND MINOR REPAIR

EAU23091

Checking and lubricating the cables

The operation of all control cables and the condition of the cables should be checked before each ride, and the cables and cable ends should be lubricated if necessary. If a cable is damaged or does not move smoothly, have a Yamaha dealer check or replace it.

Recommended lubricant:

Yamaha Chain and Cable Lube or engine oil SAE 10W-30

EWA10710

WARNING

Damage to the outer housing of cables may result in internal rusting and cause interference with cable movement. Replace damaged cables as soon as possible to prevent unsafe conditions.

EAU23111

Checking and lubricating the throttle grip and cable

The operation of the throttle grip should be checked before each ride. In addition, the cable should be lubricated at the intervals specified in the periodic maintenance chart.

EAU23172

Lubricating the front and rear brake levers

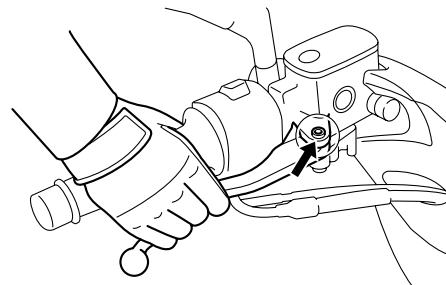

The pivoting points of the front and rear brake levers must be lubricated at the intervals specified in the periodic maintenance and lubrication chart.

Recommended lubricant:

Silicone grease

PERIODIC MAINTENANCE AND MINOR REPAIR

EAU23211

Checking and lubricating the centerstand and sidestand

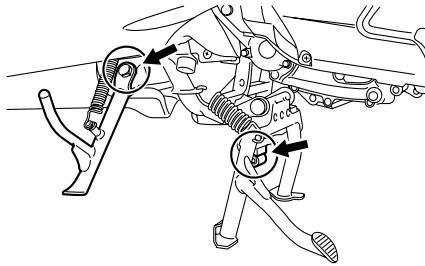
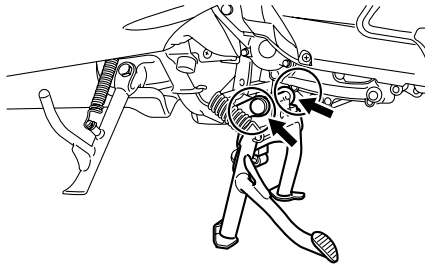

The operation of the centerstand and sidestand should be checked before each ride, and the pivots and metal-to-metal contact surfaces should be lubricated if necessary.

EWA10740

⚠ WARNING

If the centerstand or sidestand does not move up and down smoothly, have a Yamaha dealer check or repair it.

Recommended lubricant:

Lithium-soap-based grease (all-purpose grease)

EAU23271

Checking the front fork

The condition and operation of the front fork must be checked as follows at the intervals specified in the periodic maintenance and lubrication chart.

To check the condition

EWA10750

⚠ WARNING

Securely support the vehicle so that there is no danger of it falling over.

Check the inner tubes for scratches, damage and excessive oil leakage.

To check the operation

1. Place the vehicle on a level surface and hold it in an upright position.
2. While applying the front brake, push down hard on the handlebars several times to check if the front fork compresses and rebounds smoothly.

PERIODIC MAINTENANCE AND MINOR REPAIR

EAU23280

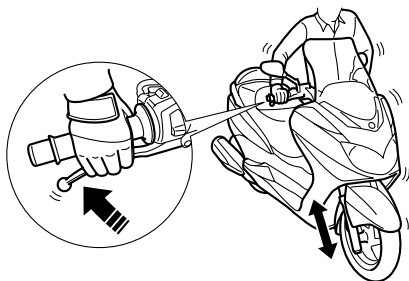

ECA10590

CAUTION:

If any damage is found or the front fork does not operate smoothly, have a Yamaha dealer check or repair it.

Checking the steering

Worn or loose steering bearings may cause danger. Therefore, the operation of the steering must be checked as follows at the intervals specified in the periodic maintenance and lubrication chart.

1. Place a stand under the engine to raise the front wheel off the ground.

EWA10750

⚠ WARNING

Securely support the vehicle so that there is no danger of it falling over.

2. Hold the lower ends of the front fork legs and try to move them forward and backward. If any free play can be felt, have a Yamaha dealer check or repair the steering.

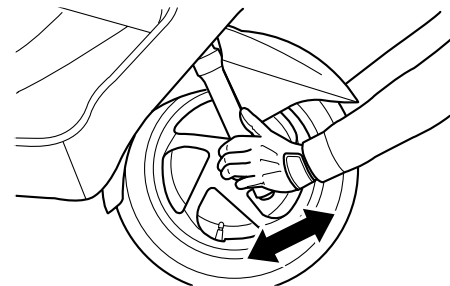

PERIODIC MAINTENANCE AND MINOR REPAIR

EAU23290

Checking the wheel bearings

The front and rear wheel bearings must be checked at the intervals specified in the periodic maintenance and lubrication chart. If there is play in the wheel hub or if the wheel does not turn smoothly, have a Yamaha dealer check the wheel bearings.

EAU34221

Battery

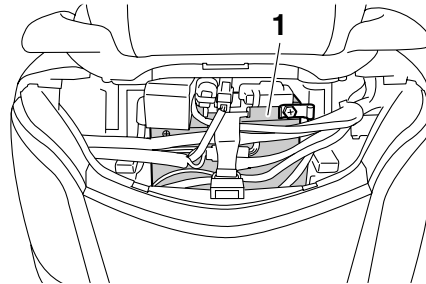

1. Battery

The battery is located behind cowling A. (See page 6-8.)

This model is equipped with a sealed-type (MF) battery, which does not require any maintenance. There is no need to check the electrolyte or to add distilled water.

EWA10760

WARNING

- **Electrolyte is poisonous and dangerous since it contains sulfuric acid, which causes severe burns. Avoid any contact with skin, eyes or clothing and always shield your eyes when**

working near batteries. In case of contact, administer the following FIRST AID.

- **EXTERNAL:** Flush with plenty of water.
- **INTERNAL:** Drink large quantities of water or milk and immediately call a physician.
- **EYES:** Flush with water for 15 minutes and seek prompt medical attention.
- **Batteries produce explosive hydrogen gas. Therefore, keep sparks, flames, cigarettes, etc., away from the battery and provide sufficient ventilation when charging it in an enclosed space.**
- **KEEP THIS AND ALL BATTERIES OUT OF THE REACH OF CHILDREN.**

To charge the battery

Have a Yamaha dealer charge the battery as soon as possible if it seems to have discharged. Keep in mind that the battery tends to discharge more quickly if the vehicle is equipped with optional

PERIODIC MAINTENANCE AND MINOR REPAIR

electrical accessories.

To store the battery

1. If the vehicle will not be used for more than one month, remove the battery, fully charge it, and then place it in a cool, dry place.
2. If the battery will be stored for more than two months, check it at least once a month and fully charge it if necessary.
3. Fully charge the battery before installation.
4. After installation, make sure that the battery leads are properly connected to the battery terminals.

ECA10630

CAUTION:

- **Always keep the battery charged. Storing a discharged battery can cause permanent battery damage.**
- **To charge a sealed-type (MF) battery, a special (constant-voltage) battery charger is required. Using a conventional battery charger will damage the battery. If you do not have access to a sealed-type (MF) battery charg-**

er, have a Yamaha dealer charge your battery.

EAU34232

Replacing the fuses

The main fuse and the fuse box, which contains the fuses for the individual circuits, are located behind cowling A. (See page 6-8.)

If a fuse is blown, replace it as follows.

1. Turn the key to "OFF" and turn off the electrical circuit in question.
2. Remove the blown fuse, and then install a new fuse of the specified amperage.

NOTE:

If the main fuse is blown, remove the grab bar to access the main fuse. After replacing the main fuse, install the grab bar. (See page 6-8.)

PERIODIC MAINTENANCE AND MINOR REPAIR

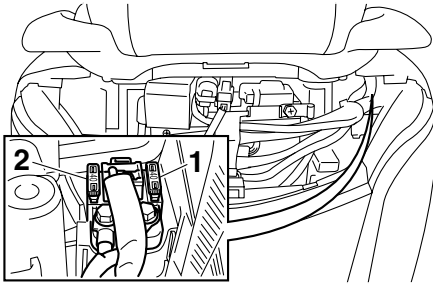

1. Spare main fuse
2. Main fuse

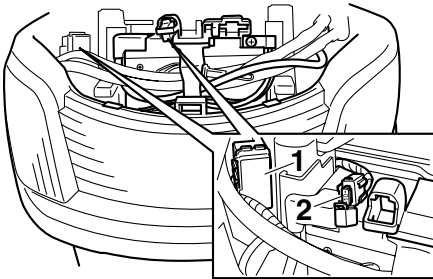

1. Fuse box
2. Taillight fuse

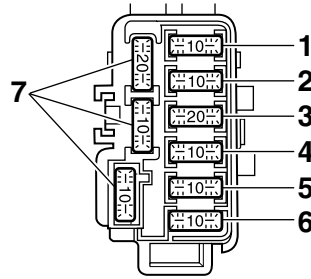

1. Ignition fuse
2. Signaling system fuse
3. Headlight fuse
4. Radiator fan fuse
5. Backup fuse (for odometer and clock)
6. Fuel injection system fuse
7. Spare fuse

Specified fuses:

- Main fuse:
40.0 A
- Ignition fuse:
10.0 A
- Signaling system fuse:
10.0 A
- Headlight fuse:
20.0 A
- Taillight fuse:
10.0 A
- Radiator fan fuse:
10.0 A
- Fuel injection system fuse:
10.0 A
- Backup fuse:
10.0 A

ECA10640

CAUTION:

Do not use a fuse of a higher amperage rating than recommended to avoid causing extensive damage to the electrical system and possibly a fire.

3. Turn the key to "ON" and turn on the electrical circuit in question to check if the device operates.
4. If the fuse immediately blows again, have a Yamaha dealer check the electrical system.

PERIODIC MAINTENANCE AND MINOR REPAIR

EAU34240

Replacing a headlight bulb

This model is equipped with quartz bulb headlights. If a headlight bulb burns out, have a Yamaha dealer replace it and, if necessary, adjust the headlight beam.

EAU24180

Tail/brake light

This model is equipped with an LED type of tail/brake light. If the tail/brake light does not come on, have a Yamaha dealer check it.

EAU36122

Replacing a front turn signal light bulb

1. Place the scooter on the center-stand.
2. Remove panel A. (See page 6-8.)
3. Remove the windshield by removing the screws.

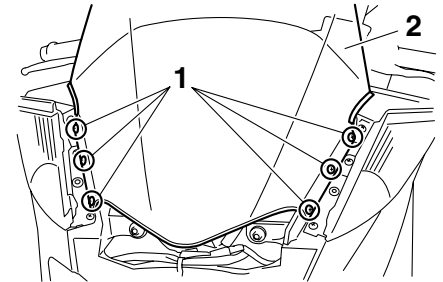

1. Screw
2. Windshield

4. Remove the front turn signal light unit by removing the screws.

PERIODIC MAINTENANCE AND MINOR REPAIR

EAU34260

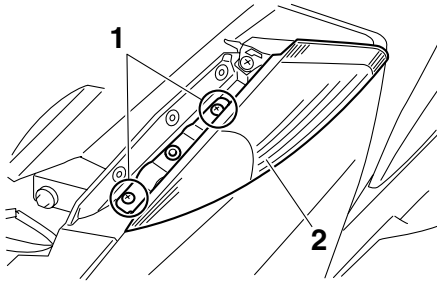

1. Screw
2. Front turn signal light unit

5. Remove the socket (together with the bulb) by turning it counterclockwise.

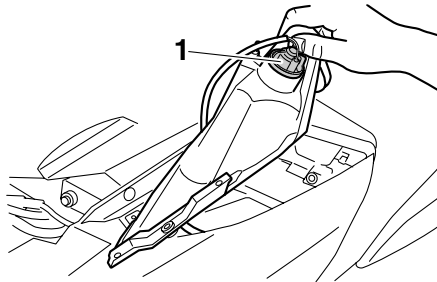

1. Turn signal light bulb socket
6. Remove the defective bulb by pushing it in and turning it counter-

clockwise.

7. Insert a new bulb into the socket, push it in, and then turn it clockwise until it stops.
8. Install the socket (together with the bulb) by turning it clockwise.
9. Place the turn signal light unit in the original position, and then install the screws.

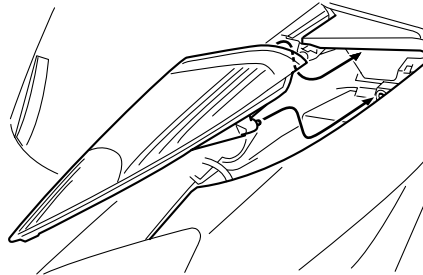

10. Install the windshield by installing the screws.
11. Install panel A.

Replacing a rear turn signal light bulb

1. Place the scooter on the center-stand.
2. Remove cowling C for replacing the left turn signal light bulb or cowling D for replacing the right turn signal light bulb. (See page 6-8.)
3. Remove the socket (together with the turn signal light bulb) by turning it counterclockwise.

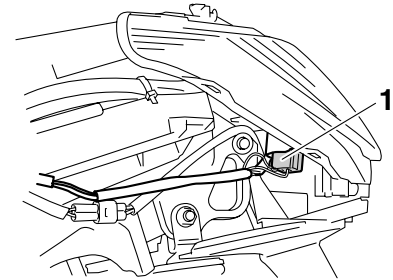

1. Turn signal light bulb socket
4. Remove the defective bulb by pushing it in and turning it counterclockwise.
5. Insert a new bulb into the socket,

PERIODIC MAINTENANCE AND MINOR REPAIR

push it in, and then turn it clockwise until it stops.

6. Install the socket (together with the bulb) by turning it clockwise.
7. Install the cowling removed.

EAU34270

Replacing the license plate light bulb

1. Remove cowling B. (See page 6-8.)
2. Remove the license plate light cover and license plate light lens by removing the screws.

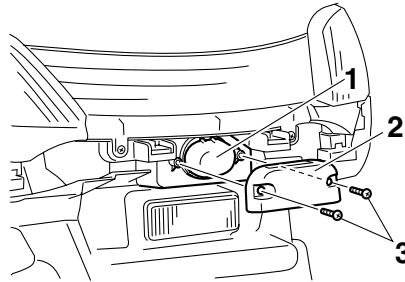

1. License plate light lens
2. License plate light cover
3. Screw

3. Remove the defective bulb by pushing it in and turning it counter-clockwise.

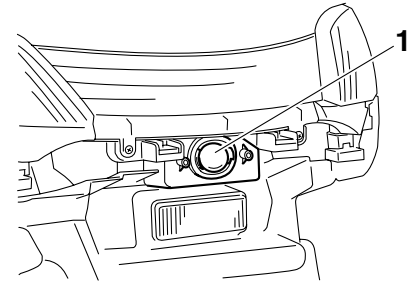

1. Bulb

4. Insert a new bulb into the socket, push it in, and then turn it clockwise until it stops.
5. Install the license plate light lens and license plate light cover by installing the screws.
6. Install the cowling.

EAU25880

Troubleshooting

Although Yamaha scooters receive a thorough inspection before shipment from the factory, trouble may occur during operation. Any problem in the fuel, compression, or ignition systems, for example, can cause poor starting and loss of power.

The following troubleshooting charts represent quick and easy procedures for checking these vital systems yourself. However, should your scooter require any repair, take it to a Yamaha dealer, whose skilled technicians have the necessary tools, experience, and know-how to service the scooter properly.

Use only genuine Yamaha replacement parts. Imitation parts may look like Yamaha parts, but they are often inferior, have a shorter service life and can lead to expensive repair bills.

PERIODIC MAINTENANCE AND MINOR REPAIR

EAU42700

Troubleshooting charts Starting problems or poor engine performance

EWA10840



WARNING

Keep away open flames and do not smoke while checking or working on the fuel system.

1. Fuel

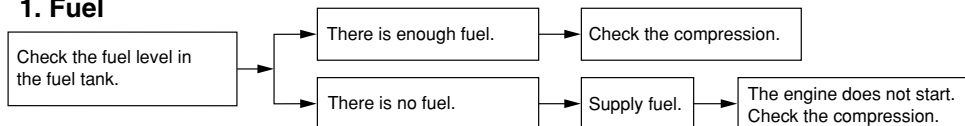

2. Compression

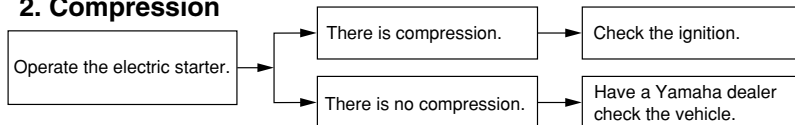

3. Ignition

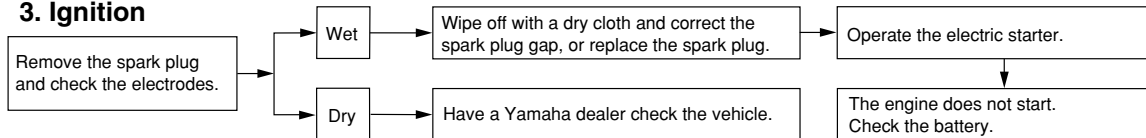

4. Battery

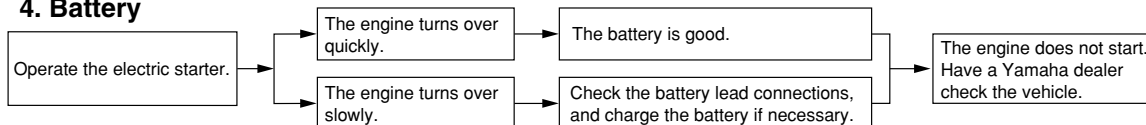

PERIODIC MAINTENANCE AND MINOR REPAIR

Engine overheating

EWAT1040

WARNING

- Do not remove the radiator cap when the engine and radiator are hot. Scalding hot fluid and steam may be blown out under pressure, which could cause serious injury. Be sure to wait until the engine has cooled.
- Place a thick rag, like a towel, over the radiator cap, and then slowly rotate the cap counterclockwise to the detent to allow any residual pressure to escape. When the hissing sound has stopped, press down on the cap while turning it counterclockwise, and then remove the cap.

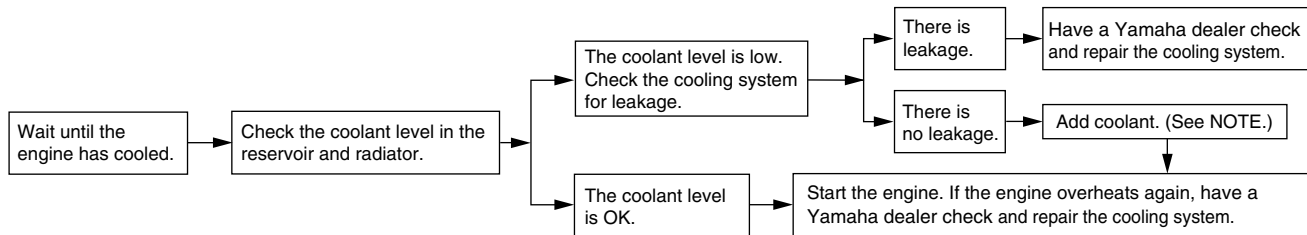

NOTE:

If coolant is not available, tap water can be temporarily used instead, provided that it is changed to the recommended coolant as soon as possible.

SCOOTER CARE AND STORAGE

Matte color caution

EAU37833

EAU26091

CAUTION:

Some models are equipped with matte colored finished parts. Be sure to consult a Yamaha dealer for advice on what products to use before cleaning the vehicle. Using a brush, harsh chemical products or cleaning compounds when cleaning these parts will scratch or damage their surface. Wax also should not be applied to any matte colored finished parts.

ECA15192

Care

While the open design of a scooter reveals the attractiveness of the technology, it also makes it more vulnerable. Rust and corrosion can develop even if high-quality components are used. A rusty exhaust pipe may go unnoticed on a car, however, it detracts from the overall appearance of a scooter. Frequent and proper care does not only comply with the terms of the warranty, but it will also keep your scooter looking good, extend its life and optimize its performance.

Before cleaning

1. Cover the muffler outlet with a plastic bag after the engine has cooled down.
2. Make sure that all caps and covers as well as all electrical couplers and connectors, including the spark plug cap, are tightly installed.
3. Remove extremely stubborn dirt, like oil burnt onto the crankcase, with a degreasing agent and a brush, but never apply such prod-

ucts onto seals, gaskets and wheel axles. Always rinse the dirt and degreaser off with water.

Cleaning

ECA10781

CAUTION:

- Avoid using strong acidic wheel cleaners, especially on spoked wheels. If such products are used on hard-to-remove dirt, do not leave the cleaner on the affected area any longer than instructed. Also, thoroughly rinse the area off with water, immediately dry it, and then apply a corrosion protection spray.
- Improper cleaning can damage plastic parts such as cowlings, panels, windshields, headlight lenses, meter lenses, etc. Use only a soft, clean cloth or sponge with mild detergent and water to clean plastic.
- Do not use any harsh chemical products on plastic parts. Be sure to avoid using cloths or sponges which have been in contact with strong or abrasive

SCOOTER CARE AND STORAGE

cleaning products, solvent or thinner, fuel (gasoline), rust removers or inhibitors, brake fluid, antifreeze or electrolyte.

- **Do not use high-pressure washers or steam-jet cleaners since they cause water seepage and deterioration in the following areas: seals (of wheel and swing-arm bearings, fork and brakes), electric components (couplers, connectors, instruments, switches and lights), breather hoses and vents.**
- **For scooters equipped with a windshield: Do not use strong cleaners or hard sponges as they will cause dulling or scratching. Some cleaning compounds for plastic may leave scratches on the windshield. Test the product on a small hidden part of the windshield to make sure that it does not leave any marks. If the windshield is scratched, use a quality plastic polishing compound after washing.**

After normal use

Remove dirt with warm water, a mild detergent, and a soft, clean sponge, and then rinse thoroughly with clean water. Use a toothbrush or bottlebrush for hard-to-reach areas. Stubborn dirt and insects will come off more easily if the area is covered with a wet cloth for a few minutes before cleaning.

After riding in the rain, near the sea or on salt-sprayed roads

Since sea salt or salt sprayed on the roads during winter are extremely corrosive in combination with water, carry out the following steps after each ride in the rain, near the sea or on salt-sprayed roads.

NOTE: _____

Salt sprayed on roads in the winter may remain well into spring.

1. Clean the scooter with cold water and a mild detergent after the engine has cooled down.

ECA10790

CAUTION: _____

Do not use warm water since it increases the corrosive action of the

salt.

2. Apply a corrosion protection spray on all metal, including chrome- and nickel-plated, surfaces to prevent corrosion.

After cleaning

1. Dry the scooter with a chamois or an absorbing cloth.
2. Use a chrome polish to shine chrome, aluminum and stainless-steel parts, including the exhaust system. (Even the thermally induced discoloring of stainless-steel exhaust systems can be removed through polishing.)
3. To prevent corrosion, it is recommended to apply a corrosion protection spray on all metal, including chrome- and nickel-plated, surfaces.
4. Use spray oil as a universal cleaner to remove any remaining dirt.
5. Touch up minor paint damage caused by stones, etc.
6. Wax all painted surfaces.
7. Let the scooter dry completely before storing or covering it.

SCOOTER CARE AND STORAGE

EWA10940

WARNING

- Make sure that there is no oil or wax on the brakes or tires. If necessary, clean the brake discs and brake linings with a regular brake disc cleaner or acetone, and wash the tires with warm water and a mild detergent.
- Before operating the scooter test its braking performance and cornering behavior.

ECA10800

CAUTION:

- Apply spray oil and wax sparingly and make sure to wipe off any excess.
- Never apply oil or wax to any rubber and plastic parts, but treat them with a suitable care product.
- Avoid using abrasive polishing compounds as they will wear away the paint.

NOTE:

Consult a Yamaha dealer for advice on

what products to use.

EAU36560

Storage

Short-term

Always store your scooter in a cool, dry place and, if necessary, protect it against dust with a porous cover.

ECA10820

CAUTION:

- Storing the scooter in a poorly ventilated room or covering it with a tarp, while it is still wet, will allow water and humidity to seep in and cause rust.
- To prevent corrosion, avoid damp cellars, stables (because of the presence of ammonia) and areas where strong chemicals are stored.

Long-term

Before storing your scooter for several months:

1. Follow all the instructions in the “Care” section of this chapter.
2. Fill up the fuel tank and add fuel stabilizer (if available) to prevent the fuel tank from rusting and the

- fuel from deteriorating.
3. Perform the following steps to protect the cylinder, piston rings, etc. from corrosion.
 - a. Remove the spark plug cap and spark plug.
 - b. Pour a teaspoonful of engine oil into the spark plug bore.
 - c. Install the spark plug cap onto the spark plug, and then place the spark plug on the cylinder head so that the electrodes are grounded. (This will limit sparking during the next step.)
 - d. Turn the engine over several times with the starter. (This will coat the cylinder wall with oil.)
 - e. Remove the spark plug cap from the spark plug, and then install the spark plug and the spark plug cap.

EWA10950



To prevent damage or injury from sparking, make sure to ground the spark plug electrodes while turning the engine over.

4. Lubricate all control cables and the

pivoting points of all levers and pedals as well as of the sidestand/centerstand.

5. Check and, if necessary, correct the tire air pressure, and then lift the scooter so that both of its wheels are off the ground. Alternatively, turn the wheels a little every month in order to prevent the tires from becoming degraded in one spot.
6. Cover the muffler outlet with a plastic bag to prevent moisture from entering it.
7. Remove the battery and fully charge it. Store it in a cool, dry place and charge it once a month. Do not store the battery in an excessively cold or warm place [less than 0 °C (30 °F) or more than 30 °C (90 °F)]. For more information on storing the battery, see page 6-33.

NOTE: _____
Make any necessary repairs before storing the scooter.

SPECIFICATIONS

EAU2633K

Dimensions:

- Overall length:
2230 mm (87.8 in)
- Overall width:
780 mm (30.7 in)
- Overall height:
1380 mm (54.3 in)
- Seat height:
760 mm (29.9 in)
- Wheelbase:
1565 mm (61.6 in)
- Ground clearance:
120 mm (4.72 in)
- Minimum turning radius:
2600 mm (102.4 in)

Weight:

- With oil and fuel:
212.0 kg (467 lb)

Engine:

- Engine type:
Liquid cooled 4-stroke, DOHC
- Cylinder arrangement:
Forward-inclined single cylinder
- Displacement:
395.0 cm³
- Bore × stroke:
83.0 × 73.0 mm (3.27 × 2.87 in)
- Compression ratio:
10.60 :1
- Starting system:
Electric starter

Lubrication system:

Wet sump

Engine oil:

Type:

YAMALUBE 4, SAE10W30 or SAE20W40

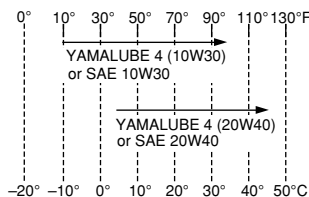

Recommended engine oil grade:

API service SG type or higher, JASO standard MA

Engine oil quantity:

Without oil filter element replacement:

1.50 L (1.59 US qt) (1.32 Imp.qt)

With oil filter element replacement:

1.70 L (1.80 US qt) (1.50 Imp.qt)

Final transmission oil:

Type:

YAMALUBE 4 (10W30) or SAE10W30 type SE motor oil

Quantity:

0.25 L (0.26 US qt) (0.22 Imp.qt)

Cooling system:

Coolant reservoir capacity (up to the maximum level mark):

0.32 L (0.34 US qt) (0.28 Imp.qt)

Radiator capacity (including all routes):

1.57 L (1.66 US qt) (1.38 Imp.qt)

Air filter:

Air filter element:

Oil-coated paper element

Fuel:

Recommended fuel:

Unleaded gasoline only

Fuel tank capacity:

14.0 L (3.70 US gal) (3.08 Imp.gal)

Fuel injection:

Throttle body:

Manufacturer:

AISAN

Spark plug (s):

Manufacturer/model:

NGK/CR7E

Spark plug gap:

0.7–0.8 mm (0.028–0.031 in)

Clutch:

Clutch type:

Dry, centrifugal automatic

Transmission:

Primary reduction system:

Helical gear

Primary reduction ratio:

31/14 (2.214)

Secondary reduction system:

Helical gear

Secondary reduction ratio:

42/16 (2.625)

Transmission type:

V-belt automatic

Operation:

Centrifugal automatic type

Chassis:

Frame type:

Aluminum die-cast and steel tube backbone

Caster angle:

27.00 °

Trail:

100.0 mm (3.94 in)

Front tire:

Type:

Tubeless

Size:

120/80-14M/C 58S

Manufacturer/model:

IRC/MB67

Manufacturer/model:

DUNLOP/D305FL

Rear tire:

Type:

Tubeless

Size:

150/70-13M/C 64S

Manufacturer/model:

IRC/MB67

Manufacturer/model:

DUNLOP/D305L

Loading:

Maximum load:

196 kg (432 lb)

* (Total weight of rider, passenger, cargo and accessories)

Tire air pressure (measured on cold tires):

Loading condition:

0–90 kg (0–198 lb)

Front:

200 kPa (29 psi) (2.00 kgf/cm²)

Rear:

250 kPa (36 psi) (2.50 kgf/cm²)

Loading condition:

90–196 kg (198–432 lb)

Front:

200 kPa (29 psi) (2.00 kgf/cm²)

Rear:

250 kPa (36 psi) (2.50 kgf/cm²)

Front wheel:

Wheel type:

Cast wheel

Rim size:

14 x MT3.00

Rear wheel:

Wheel type:

Cast wheel

Rim size:

13 x MT4.00

Front brake:

Type:

Single disc brake

Operation:

Right hand operation

Recommended fluid:

DOT 4

Rear brake:

Type:

Single disc brake

Operation:

Left hand operation

Recommended fluid:

DOT 4

Front suspension:

Type:

Telescopic fork

Spring/shock absorber type:

Coil spring/oil damper

Wheel travel:

120.0 mm (4.72 in)

Rear suspension:

Type:

Unit swing

Spring/shock absorber type:

Coil spring/oil damper

Wheel travel:

104.0 mm (4.09 in)

Electrical system:

Ignition system:

Transistorized coil ignition (digital)

Charging system:

AC magneto

Battery:

Model:

GT9B-4

Voltage, capacity:

12 V, 8.0 Ah

SPECIFICATIONS

Headlight:

Bulb type:
Halogen bulb

Bulb voltage, wattage × quantity:

Headlight:
12 V, 60 W/55.0 W × 2

Tail/brake light:
LED

Front turn signal/position light:
12 V, 21 W/5.0 W × 2

Rear turn signal light:
12 V, 21.0 W × 2

License plate light:
12 V, 5.0 W × 1

Meter lighting:
12 V, 2.0 W × 3

High beam indicator light:
12 V, 1.4 W × 1

Turn signal indicator light:
12 V, 1.4 W × 2

Engine trouble warning light:
12 V, 1.4 W × 1

Fuses:

Main fuse:
40.0 A

Headlight fuse:
20.0 A

Taillight fuse:
10.0 A

Signaling system fuse:
10.0 A

Ignition fuse:
10.0 A

Radiator fan fuse:

10.0 A

Fuel injection system fuse:

10.0 A

Backup fuse:

10.0 A

EAU26351

Identification numbers

Record the key identification number, vehicle identification number and model label information in the spaces provided below for assistance when ordering spare parts from a Yamaha dealer or for reference in case the vehicle is stolen.

KEY IDENTIFICATION NUMBER:

VEHICLE IDENTIFICATION NUMBER:

MODEL LABEL INFORMATION:

EAU26381

Key identification number

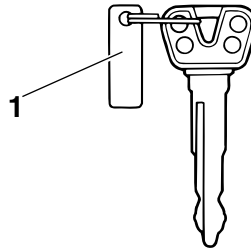

1. Key identification number

The key identification number is stamped into the key tag. Record this number in the space provided and use it for reference when ordering a new key.

EAU26410

Vehicle identification number

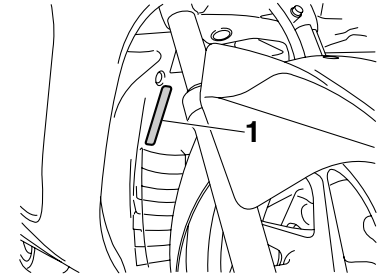

1. Vehicle identification number

The vehicle identification number is stamped into the frame.

NOTE: _____

The vehicle identification number is used to identify your vehicle and may be used to register it with the licensing authority in your area.

CONSUMER INFORMATION

EAU26500

Model label

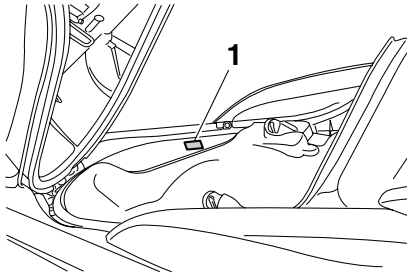

1. Model label

The model label is affixed to the inside of the rear storage compartment. (See page 3-13.) Record the information on this label in the space provided. This information will be needed when ordering spare parts from a Yamaha dealer.

Reporting safety defects

If you believe that your vehicle has a defect which could cause a crash or could cause injury or death, you should immediately inform the National Highway Traffic Safety Administration (NHTSA) in addition to notifying Yamaha Motor Corporation, U.S.A. If NHTSA receives similar complaints, it may open an investigation, and if it finds that a safety defect exists in a group of vehicles, it may order a recall and remedy campaign. However, NHTSA cannot become involved in individual problems between you, your dealer, or Yamaha Motor Corporation, U.S.A.

To contact NHTSA, you may call the Vehicle Safety Hotline toll-free at 1-888-327-4236 (TTY: 1-800-424-9153); go to <http://www.safercar.gov>; or write to: Administrator, NHTSA, 400 Seventh Street, SW., Washington, DC 20590. You can also obtain other information about motor vehicle safety from <http://www.safercar.gov>.

Scooter noise regulation

TAMPERING WITH NOISE CONTROL SYSTEM PROHIBITED:

Federal law prohibits the following acts or the causing thereof: (1) The removal or rendering inoperative by any person other than for purposes of maintenance, repair, or replacement of any device or element of design incorporated into any new vehicle for the purpose of noise control prior to its sale or delivery to the ultimate purchaser or while it is in use or (2) the use of the vehicle after such device or element of design has been removed or rendered inoperative by any person.

“AMONG THOSE ACTS PRESUMED TO CONSTITUTE TAMPERING ARE THE ACTS LISTED BELOW.”

These acts include tampering with the following systems; i.e., modification, removal, etc.

Exhaust system

- Muffler
- Exhaust pipe
- Silencer

Intake system

- Air cleaner case
- Air cleaner element
- Intake duct

Maintenance record

Copies of work orders and/or receipts for parts purchased and installed on your vehicle will be required to document that maintenance has been completed in accordance with the emissions warranty. The chart below is printed only as a reminder that maintenance work is required. It is not acceptable proof of maintenance work.

Maintenance interval	Date of service	Mileage	Servicing dealer name and address	Remarks
600 mi (1000 km) or 1 month				
4000 mi (7000 km) or 6 months				
8000 mi (13000 km) or 12 months				
12000 mi (19000 km) or 18 months				
16000 mi (25000 km) or 24 months				
20000 mi (31000 km) or 30 months				
24000 mi (37000 km) or 36 months				
28000 mi (43000 km) or 42 months				

CONSUMER INFORMATION

Maintenance interval	Date of service	Mileage	Servicing dealer name and address	Remarks
32000 mi (49000 km) or 48 months				
36000 mi (55000 km) or 54 months				
40000 mi (61000 km) or 60 months				

YAMAHA MOTOR CORPORATION, U.S.A. STREET AND ENDURO MOTORCYCLE LIMITED WARRANTY

Yamaha Motor Corporation, U.S.A. hereby warrants that new Yamaha motorcycles will be free from defects in material and workmanship for the period of time stated herein, subject to certain stated limitations.

THE PERIOD OF WARRANTY for Yamaha motorcycles originally equipped with headlight, stoplight, and turn signals shall be one (1) year from the date of purchase, with no mileage limitation.

MODELS EXCLUDED FROM WARRANTY include those used for non-Yamaha-authorized renting, leasing or other commercial purposes, and TZ models.

DURING THE PERIOD OF WARRANTY, any authorized Yamaha motorcycle dealer will, free of charge, repair or replace any part adjudged defective by Yamaha due to faulty workmanship or material from the factory. Parts used in warranty repairs will be warranted for the balance of the product's warranty period. All parts replaced under warranty become property of Yamaha Motor Corporation, U.S.A.

GENERAL EXCLUSIONS from this warranty shall include any failures caused by:

- a) Competition or racing use.
- b) Installation of parts or accessories that are not qualitatively equivalent to genuine Yamaha parts.
- c) Abnormal strain, neglect, or abuse.
- d) Lack of proper maintenance.
- e) Accident or collision damage.
- f) Modification to original parts.

SPECIFIC EXCLUSIONS from this warranty shall include parts replaced due to normal wear or routine maintenance.

THE CUSTOMER'S RESPONSIBILITY under this warranty shall be to:

1. Operate and maintain the motorcycle as specified in the appropriate Owner's Manual, and
2. Give notice to an authorized Yamaha motorcycle dealer of any and all apparent defects within ten (10) days after discovery, and make the machine available at that time for inspection and repairs at such dealer's place of business.

WARRANTY TRANSFER: To transfer the warranty from the original purchaser to any subsequent purchaser, it is imperative that the machine be inspected and registered for warranty by an authorized Yamaha motorcycle dealer. In order for this warranty to remain in effect, this inspection and registration must take place within ten (10) days after transfer. An inspection and registration fee will be charged for this service.

EMISSION CONTROL SYSTEM WARRANTY:

Yamaha Motor Corporation, U.S.A. also warrants to the ultimate purchaser and each subsequent purchaser of each Yamaha motorcycle covered by this warranty with a displacement of 50cc or greater, that the vehicle is designed, built, and equipped so as to conform at the time of sale with all U.S. emissions standards applicable at the time of manufacture and that it is free from defects in materials and workmanship which would cause it not to meet these standards within the period listed immediately below. Failures other than those resulting from defects in material or workmanship, which arise solely as a result of owner abuse and/or lack of proper maintenance, are not covered by this warranty.

Engine Displacement	Period
Under 50cc	6,000 km (3,750 miles) or five years, whichever occurs first
50cc to 169cc	12,000 km (7,465 miles) or five years whichever occurs first
170cc to 279cc	18,000 km (11,185 miles) or five years, whichever occurs first
280cc and over	30,000 km (18,641 miles) or five years, whichever occurs first

YAMAHA MOTOR CORPORATION, U.S.A. MAKES NO OTHER WARRANTY OF ANY KIND, EXPRESSED OR IMPLIED. ALL IMPLIED WARRANTIES OF MERCHANTABILITY AND FITNESS FOR A PARTICULAR PURPOSE WHICH EXCEED THE OBLIGATIONS AND TIME LIMITS STATED IN THIS WARRANTY ARE HEREBY DISCLAIMED BY YAMAHA MOTOR CORPORATION, U.S.A. AND EXCLUDED FROM THIS WARRANTY.

SOME STATES DO NOT ALLOW LIMITATIONS ON HOW LONG AN IMPLIED WARRANTY LASTS, SO THE ABOVE LIMITATION MAY NOT APPLY TO YOU. ALSO EXCLUDED FROM THIS WARRANTY ARE ANY INCIDENTAL OR CONSEQUENTIAL DAMAGES INCLUDING LOSS OF USE. SOME STATES DO NOT ALLOW THE EXCLUSION OR LIMITATION OF INCIDENTAL OR CONSEQUENTIAL DAMAGES, SO THE ABOVE EXCLUSION MAY NOT APPLY TO YOU.

THIS WARRANTY GIVES YOU SPECIFIC LEGAL RIGHTS, AND YOU MAY ALSO HAVE OTHER RIGHTS WHICH VARY FROM STATE TO STATE.

YAMAHA MOTOR CORPORATION, U.S.A.
P.O. Box 6555
Cypress, California 90630

CONSUMER INFORMATION

WARRANTY QUESTIONS AND ANSWERS

- Q. What costs are my responsibility during the warranty period?
- A. The customer's responsibility includes all costs of normal maintenance services, non-warranty repairs, accident and collision damages, and oil, oil filters, air filters, spark plugs, and brake shoes.
- Q. What are some examples of "abnormal" strain, neglect, or abuse?
- A. These terms are general and overlap each other in areas. Specific examples include: Running the machine out of oil, sustained high rpm, full-throttle, operating the machine with a broken or damaged part which causes another part to fail, damage or failure due to improper or careless transportation and/or tie-down. If you have any specific questions on operation or maintenance, please contact your dealer for advice.
- Q. Does the warranty cover incidental costs such as towing or transportation due to a failure?
- A. No. The warranty is limited to repair of the machine itself.
- Q. May I perform any or all of the recommended maintenance shown in the Owner's Manual instead of having the dealer do them?
- A. Yes, if you are a qualified mechanic and follow the procedures specified in the Owner's and Service Manual. We do recommend, however, that items requiring special tools or equipment be done by a Yamaha motorcycle dealer.
- Q. Will the warranty be void or cancelled if I do not operate or maintain my new motorcycle exactly as specified in the Owner's Manual?
- A. No. The warranty on a new motorcycle cannot be "voided" or "cancelled." **However, if a particular failure is caused by operation or maintenance other than as described in the Owner's Manual, that failure may not be covered under warranty.**
- Q. What responsibility does my dealer have under this warranty?
- A. Each Yamaha motorcycle dealer is expected to:
1. Completely set up every new machine before sale.
 2. Explain the operation, maintenance, and warranty requirements to your satisfaction at the time of sale, and upon your request at any later date.
 3. Each Yamaha motorcycle dealer is held responsible for his setup, service and warranty repair work.
- Q. Is the warranty transferable to second owners?
- A. Yes. The remainder of the existing warranty can be transferred upon request. The unit has to be inspected and re-registered by an authorized Yamaha motorcycle dealer for the policy to remain effective.

CUSTOMER SERVICE

If your machine requires warranty service, you must take it to any authorized Yamaha motorcycle dealer within the continental United States. Be sure to bring your warranty registration card or other valid proof of the original date of purchase. If a question or problem arises regarding the warranty, first contact the owner of the dealership. Since all warranty matters are handled at the dealer level, this person is in the best position to help you. If you are still not satisfied and require additional assistance, please write to:

YAMAHA MOTOR CORPORATION, U.S.A.
CUSTOMER RELATIONS DEPARTMENT
P.O. Box 6555
Cypress, California 90630

When contacting Yamaha Motor Corporation, U.S.A., don't forget to include any important information such as names, addresses, model, V.I.N. (frame number), dates, and receipts.

CHANGE OF ADDRESS

The federal government requires each manufacturer of a motor vehicle to maintain a complete, up-to-date list of all first purchasers against the possibility of a safety-related defect and recall. This list is compiled from the purchase registrations sent to Yamaha Motor Corporation, U.S.A. by the selling dealer at the time of your purchase.

If you should move after you have purchased your new motorcycle, please advise us of your new address by sending a postcard listing your motorcycle model name, V.I.N. (frame number), dealer number (or dealer's name) as it is shown on your warranty card, your name and new mailing address. Mail to:

YAMAHA MOTOR CORPORATION, U.S.A.
P.O. Box 6555
Cypress, California 90630
Attention: Warranty Department

This will ensure that Yamaha Motor Corporation, U.S.A. has an up-to-date registration record in accordance with federal law.

YAMAHA EXTENDED SERVICE (Y.E.S.)

Keep your Yamaha protected even after your warranty expires with genuine Yamaha Extended Service (Y.E.S.).

- Y.E.S. is designed and administered by Yamaha Motor Corporation to provide maximum owner satisfaction. You get uninterrupted factory-backed coverage for extra peace of mind.
 - Y.E.S. is flexible. You choose the plan that's right for you: 12 months, 24 months, 36 months or, on certain models, even 48 months beyond your warranty period.
 - Y.E.S. is designed and administered by the same Yamaha people who handle your warranty – and it shows in the comprehensive coverage benefits. There are no mileage limitations. Coverage isn't limited to "moving parts" or the "drive train" like many other plans. And Y.E.S. covers manufacturing defects just like the warranty. See the sample contract at your Yamaha dealer to see how comforting uninterrupted factory-backed protection can be.
 - You don't have to pay anything for covered repairs. There's no deductible to pay, and repairs aren't "pro-rated." You don't have any "out-of-pocket" expenses for covered repairs.
- In addition, Travel and Recreation Interruption Protection (TRIP) is included at no extra cost. TRIP gives you up to \$150 reimbursement per occurrence for any reasonable expenses you incur because your Yamaha needs covered service: replacement vehicle rental, emergency towing, phone calls, even food and lodging when you are away from home. This superb coverage goes into effect when you purchase Y.E.S., so it applies to any warranty repairs as well as covered repairs during your entire Y.E.S. plan period.
 - Y.E.S. coverage is honored at any authorized Yamaha dealer nationwide.
 - Y.E.S. coverage is transferable to a new owner if you sell or trade-in. That can make your Yamaha much more valuable!

This excellent Y.E.S. plan coverage is only available to Yamaha owners like you, and only while your Yamaha is still within the Yamaha Limited Warranty period. So visit your authorized Yamaha dealer to get all the facts. He can show you how easy it is to protect your investment with Yamaha Extended Service.

CONSUMER INFORMATION

We urge you to act now. You'll get the excellent benefits of TRIP coverage right away, and you'll rest easy knowing you'll have strong factory-backed protection even after your Yamaha Limited Warranty expires.

A special note:

If visiting your dealer isn't convenient, contact Yamaha with your Primary ID number (your frame number). We'll be happy to help you get the Y.E.S. coverage you need.

Yamaha Service Marketing
P.O. Box 6555
Cypress, CA 90630
1-(866)-YES-EXTD (1-866-937-3983)



YAMAHA



EXTENDED



SERVICE

- A**
- Acceleration and deceleration5-2
 - Accessories and replacement parts6-26
 - Air filter elements and check hoses and V-belt case air filter element6-20
- B**
- Battery6-33
 - Brake fluid, changing6-29
 - Brake fluid level, checking6-28
 - Brake lever, front3-8
 - Brake lever, rear3-8
 - Brake levers, lubricating6-30
 - Braking5-2
- C**
- Cables, checking and lubricating6-30
 - Canister6-14
 - Care7-1
 - Catalytic converter3-11
 - Centerstand and sidestand, checking and lubricating6-31
 - Coolant6-18
 - Cowlings and panels, removing and installing6-8
- D**
- Dimmer switch3-7
- E**
- Engine break-in5-3
 - Engine oil and oil filter element6-14
 - Engine stop switch3-7
 - Engine trouble warning light3-2
- F**
- Final transmission oil6-17
 - Front and rear brake lever free play6-26
 - Front and rear brake pads, checking6-28
 - Front fork, checking6-31
 - Fuel3-10
 - Fuel tank cap3-9
 - Fuses, replacing6-34
- H**
- Handlebar switches3-7
 - Headlight bulb, replacing6-36
 - High beam indicator light3-2
 - Horn switch3-7
- I**
- Identification numbers9-1
 - Ignition circuit cut-off system3-16
 - Indicator and warning lights3-2
- K**
- Key identification number9-1
- L**
- Labels, location of1-6
 - License plate light bulb, replacing6-38
- M**
- Main switch/steering lock3-1
 - Maintenance and lubrication, periodic6-4
 - Maintenance, emission control system6-3
 - Maintenance, periodic6-1
 - Maintenance record9-5
 - Matte color, caution7-1
 - Model label9-2
 - Multi-function display3-3
- N**
- Noise regulation9-4
- P**
- Parking5-4
 - Part locations2-1
 - Pre-operation check list4-2
- R**
- Rear brake lock lever3-8
 - Rear brake lock lever cable, adjusting6-27
 - Rider seat, adjusting3-13
- S**
- Safe-riding points1-4
 - Safety defects, reporting9-3
 - Safety information1-1
 - Seats3-11
 - Shock absorber assemblies, adjusting...3-15
 - Sidestand3-16
 - Spark plug, checking6-12
 - Specifications8-1
 - Speedometer3-2
 - Starting off5-2
 - Starting the engine5-1
 - Start switch3-7
 - Steering, checking6-32
 - Storage7-3
 - Storage compartments3-13
- T**
- Tachometer3-3
 - Tail/brake light6-36
 - Throttle cable free play, checking6-23
 - Throttle grip and cable, checking and lubricating6-30
 - Tires6-23
 - Tool kit6-2
 - Troubleshooting6-39
 - Troubleshooting charts6-40
 - Turn signal indicator lights3-2
 - Turn signal light bulb (front), replacing6-36
 - Turn signal light bulb (rear), replacing6-37
 - Turn signal switch3-7

INDEX

V

- Valve clearance 6-23
- Vehicle identification number 9-1

W

- Warranty, extended..... 9-9
- Warranty, limited 9-7
- Wheel bearings, checking..... 6-33
- Wheels 6-25

PROTECT YOUR INVESTMENT
Use Genuine YAMAHA Parts And Accessories.

***See your Authorized YAMAHA Dealer for a Genuine YAMAHA
Service Manual.***



YAMAHA MOTOR CO., LTD.

PRINTED ON RECYCLED PAPER

Download from www.somanuals.com. All Manuals Search And Download.

PRINTED IN JAPAN
2007.6-0.4x1 
(E)

Free Manuals Download Website

<http://myh66.com>

<http://usermanuals.us>

<http://www.somanuals.com>

<http://www.4manuals.cc>

<http://www.manual-lib.com>

<http://www.404manual.com>

<http://www.luxmanual.com>

<http://aubethermostatmanual.com>

Golf course search by state

<http://golfingnear.com>

Email search by domain

<http://emailbydomain.com>

Auto manuals search

<http://auto.somanuals.com>

TV manuals search

<http://tv.somanuals.com>