

YAMAHA CDC-625

Natural Sound Compact Disc Player

5-Disc Carousel Auto-changer

PLAYXCHANGE; Disc changing capability while playing another

Random Access Programmable Play

Random-Sequence Play

Single Track/Entire Disc/All Disc Repeat Play

Remote Control Capability

Thank you for selecting this YAMAHA Compact Disc Player.



OWNER'S MANUAL

CONTENTS

Safety Instructions.....	2
Connections	4
Identification of Components....	5
Loading the Disc/Disc Play.....	6
Random-Sequence Play	9
Program Play.....	10
Repeat Play	12
Index Search	12
Notes about the Remote Control Transmitter	13
Notes about Handling	
Compact Discs	13
Troubleshooting	14
Specifications	14

IMPORTANT!

Please record the serial number of this unit in the space below.

Model:
Serial No.:

The serial number is located on the rear of the unit.
Retain this Owner's Manual in a safe place for future reference.

WARNING

TO REDUCE THE RISK OF FIRE OR ELECTRIC SHOCK, DO NOT EXPOSE THIS UNIT TO RAIN OR MOISTURE.

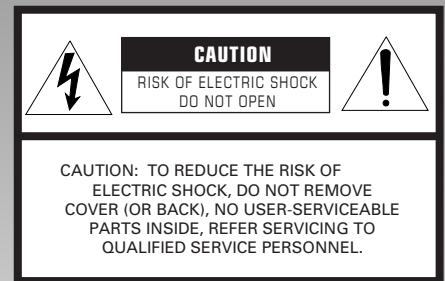

• Explanation of Graphical Symbols





The lightning flash with arrowhead symbol, within an equilateral triangle, is intended to alert you to the presence of uninsulated "dangerous voltage" within the product's enclosure that may be of sufficient magnitude to constitute a risk of electric shock to persons.



The exclamation point within an equilateral triangle is intended to alert you to the presence of important operating and maintenance (servicing) instructions in the literature accompanying the appliance.

SAFETY INSTRUCTIONS

	CAUTION RISK OF ELECTRIC SHOCK DO NOT OPEN	
CAUTION: TO REDUCE THE RISK OF ELECTRIC SHOCK, DO NOT REMOVE COVER (OR BACK). NO USER-SERVICEABLE PARTS INSIDE. REFER SERVICING TO QUALIFIED SERVICE PERSONNEL.		

• Explanation of Graphical Symbols

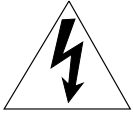

The lightning flash with arrowhead symbol, within an equilateral triangle, is intended to alert you to the presence of uninsulated "dangerous voltage" within the product's enclosure that may be of sufficient magnitude to constitute a risk of electric shock to persons.



The exclamation point within an equilateral triangle is intended to alert you to the presence of important operating and maintenance (servicing) instructions in the literature accompanying the appliance.

WARNING

TO REDUCE THE RISK OF FIRE OR ELECTRIC SHOCK, DO NOT EXPOSE THIS UNIT TO RAIN OR MOISTURE.

- 1** Read Instructions – All the safety and operating instructions should be read before the unit is operated.
- 2** Retain Instructions – The safety and operating instructions should be retained for future reference.
- 3** Heed Warnings – All warnings on the unit and in the operating instructions should be adhered to.
- 4** Follow Instructions – All operating and other instructions should be followed.
- 5** Water and Moisture – The unit should not be used near water – for example, near a bathtub, washbowl, kitchen sink, laundry tub, in a wet basement, or near a swimming pool, etc.
- 6** Carts and Stands – The unit should be used only with a cart or stand that is recommended by the manufacturer.
- 6A** A unit and cart combination should be moved with care. Quick stops, excessive force, and uneven surfaces may cause the unit and cart combination to overturn.
- 7** Wall or Ceiling Mounting – The unit should be mounted to a wall or ceiling only as recommended by the manufacturer.
- 8** Ventilation – The unit should be situated so that its location or position does not interfere with its proper ventilation. For example, the unit should not be situated on a bed, sofa, rug, or similar surface, that may block the ventilation openings; or placed in a built-in installation, such as a bookcase or cabinet that may impede the flow of air through the ventilation openings.



- 9** Heat – The unit should be situated away from heat sources such as radiators, stoves, or other appliances that produce heat.
- 10** Power Sources – The unit should be connected to a power supply only of the type described in the operating instructions or as marked on the unit.
- 11** Power-Cord Protection – Power-supply cords should be routed so that they are not likely to be walked on or pinched by items placed upon or against them, paying particular attention to cords at plugs, convenience receptacles, and the point where they exit from the unit.
- 12** Cleaning – The unit should be cleaned only as recommended by the manufacturer.
- 13** Nonuse Periods – The power cord of the unit should be unplugged from the outlet when left unused for a long period of time.
- 14** Object and Liquid Entry – Care should be taken so that objects do not fall into and liquids are not spilled into the inside of the unit.
- 15** Damage Requiring Service – The unit should be serviced by qualified service personnel when:
 - A.** The power-supply cord or the plug has been damaged; or
 - B.** Objects have fallen, or liquid has been spilled into the unit; or
 - C.** The unit has been exposed to rain; or
 - D.** The unit does not appear to operate normally or exhibits a marked change in performance; or
 - E.** The unit has been dropped, or the cabinet damaged.
- 16** Servicing – The user should not attempt to service the unit beyond those means described in the operating instructions. All other servicing should be referred to qualified service personnel.
- 17** Power Lines – An outdoor antenna should be located away from power lines.
- 18** Grounding or Polarization – Precautions should be taken so that the grounding or polarization is not defeated.

IMPORTANT!

Please record the serial number of this unit in the space below.

Model:
Serial No.:

The serial number is located on the rear of the unit. Retain this Owner's Manual in a safe place for future reference

CAUTION: READ THIS BEFORE OPERATING YOUR UNIT

- 1 To ensure the finest performance, please read this manual carefully. Keep it in a safe place for future reference.
- 2 Install your unit in a cool, dry, clean place – away from windows, heat sources, and too much vibration, dust, moisture or cold. Avoid sources of hum (transformers, motors). To prevent fire or electrical shock, do not expose to rain and water.
- 3 Do not operate the unit upside-down. It may overheat, possibly causing damage.
- 4 Never open the cabinet. If a foreign object drops into the set, contact your dealer.
- 5 Do not use force on switches, knobs or cords. When moving the set, first turn the unit off. Then gently disconnect the power plug and the cords connecting to other equipment. Never pull the cord itself.
- 6 Do not attempt to clean the unit with chemical solvents; this might damage the finish. Use a clean, dry cloth.
- 7 Be sure to read the “TROUBLESHOOTING” section on common operating errors before concluding that your unit is faulty.
8. Do not place another component on top of this unit, because to do so will discolor or damage the surface of the unit.
9. To prevent damage by lightning, disconnect the power cord from the household AC outlet during an electrical storm.
10. When disconnecting the power cord from the household AC outlet, grasp the plug; do not pull the cord.
11. When moving the unit, be sure to first disconnect the power cord from the household AC outlet, and disconnect cords connected to other equipment.

CAUTION FOR CARRYING THIS UNIT

Be sure not to carry or tip the unit with discs remaining in it.

CAUTION FOR MOVING THIS UNIT

When moving this unit, first remove all discs from the disc tray and close the tray by pressing the **OPEN/CLOSE** button, and then switch off the power after you confirm that the display indicates as follows.



Never switch off the power if the display is not pictured as above, otherwise the unit will get out of order during moving because the internal mechanism is not locked.

WARNING

CAUTION

Use of controls or adjustments or performance of procedures other than those specified herein may result in hazardous radiation exposure.

DANGER

Invisible laser radiation when open and interlock failed or defeated.
Avoid direct exposure to beam.

Laser Diode Properties

- Material: GaAlAs
- Wavelength: 780nm
- Emission Duration: continuous
- Laser Output: max. 44.6µW*

* This output is the value measured at a distance of about 200mm from the objective lens surface on the Optical Pick-up Block.

As the laser beam used in this compact disc player is harmful to the eyes, do not attempt to disassemble the cabinet. Refer servicing to qualified personnel only.

To avoid electrical shock, do not open the unit. Refer servicing to qualified personnel only.

DANGER: The use of optical instrument with this product will increase eye hazard.

The apparatus is not disconnected from the AC power source as long as it is connected to the wall outlet, even if the apparatus itself is turned off.

We Want You Listening For A Lifetime

YAMAHA and the Electronic Industries Association's Consumer Electronics Group want you to get the most out of your equipment by playing it at a safe level. One that lets the sound come through loud and clear without annoying blaring or distortion – and, most importantly, without affecting your sensitive hearing. Since hearing damage from loud sounds is

often undetectable until it is too late, YAMAHA and the Electronic Industries Association's Consumer Electronics Group recommend you to avoid prolonged exposure from excessive volume levels.



CONNECTIONS

- Before making any connections, switch OFF the power to the unit and the amplifier or other component.
- Connect the "LINE OUT" terminals to the "CD" (or "AUX") terminals of the amplifier. If the amplifier does not have such terminals, use the "TAPE PB" terminals. For additional details concerning these connections, refer to the operation instructions for the amplifier being used.
- Be sure that the left (L) and right (R) LINE OUT terminals are connected to the corresponding (left and right) terminals of the amplifier or other component.
- If the placement of this unit causes noise to other equipment, such as a tuner, separate them from each other.

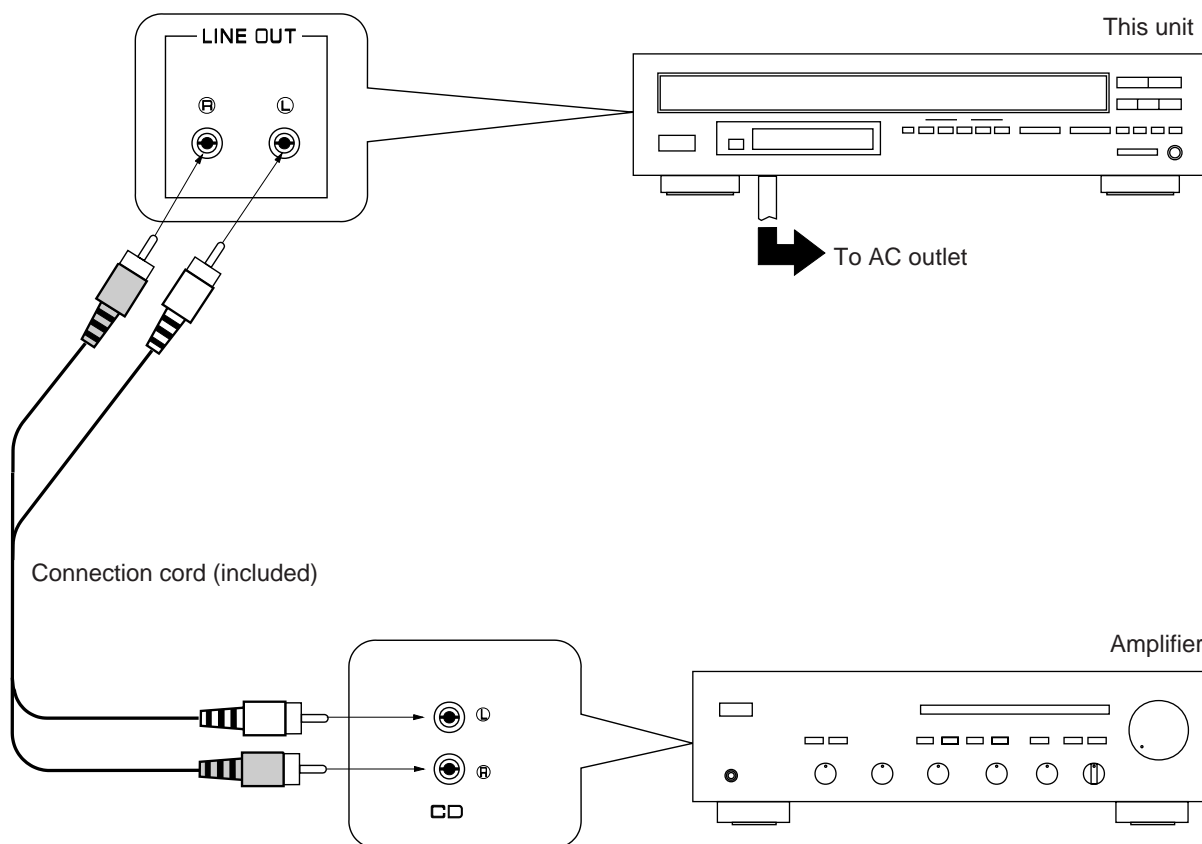

IDENTIFICATION OF COMPONENTS

FRONT PANEL

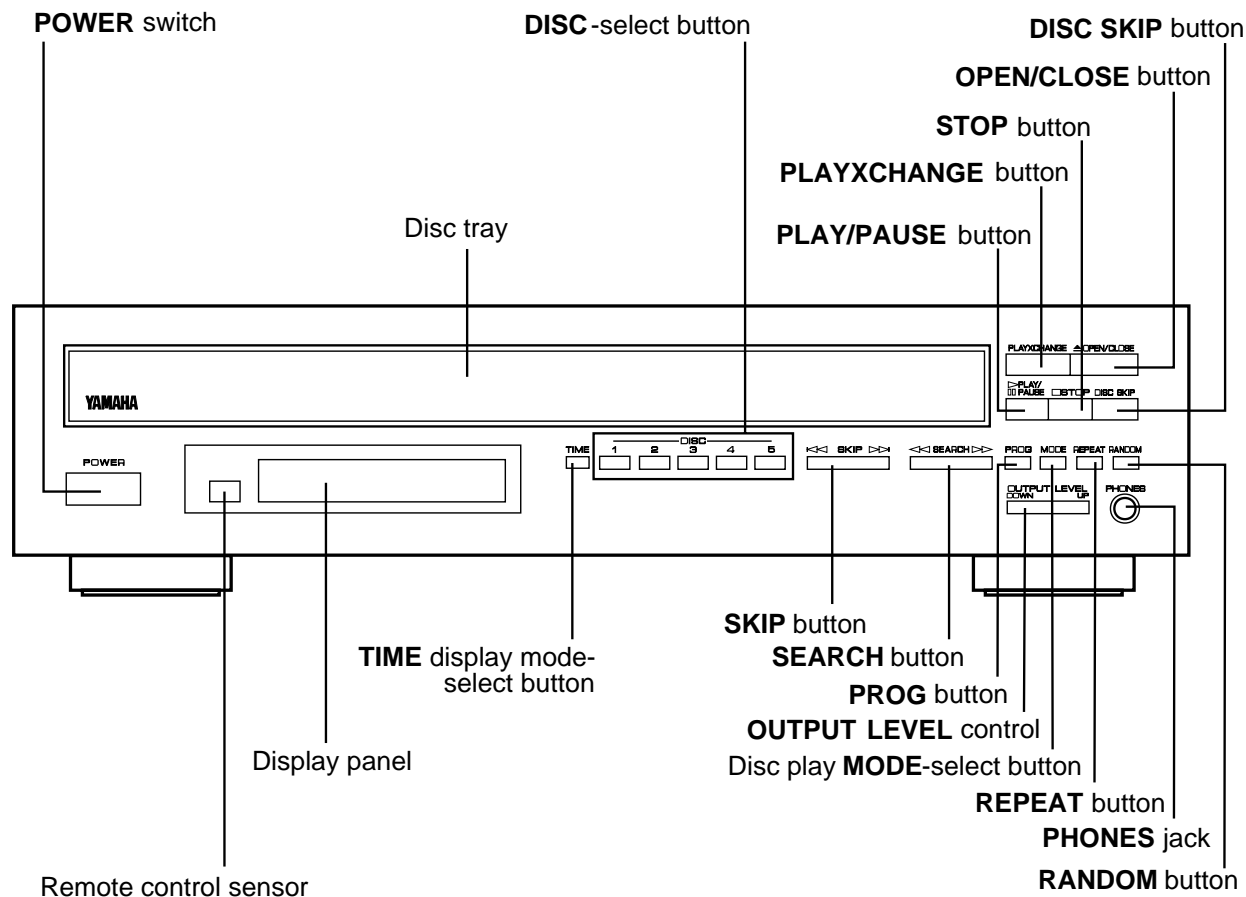

REMOTE CONTROL TRANSMITTER

The control functions on the main unit and on the remote-control transmitter are virtually identical, with the exceptions described below.

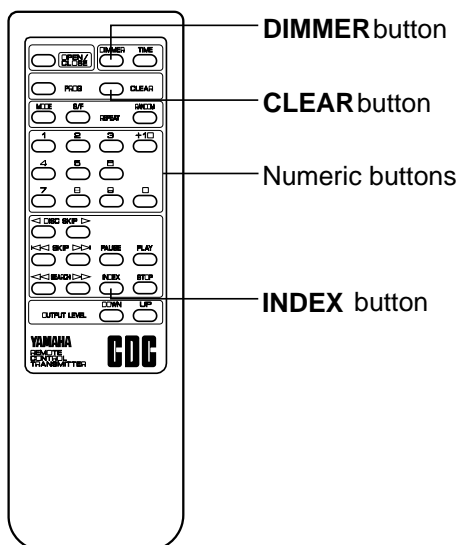

* The **PLAY/PAUSE** button on the main unit has both the functions of the **PLAY** button and the **PAUSE** button on the remote control transmitter

* Remote control transmitter has two **DISC SKIP** buttons. Pressing each button will search discs in the direction shown by the arrow.

LOADING THE DISC/DISC PLAY

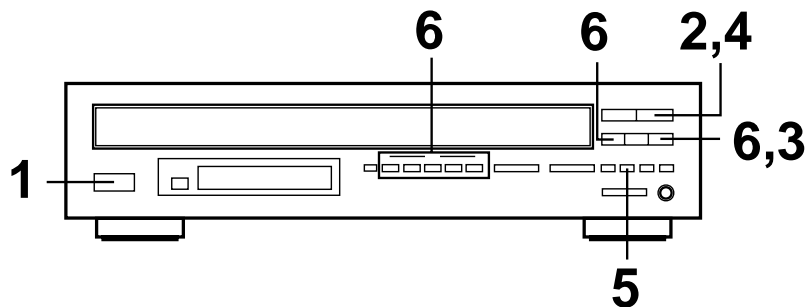

1 POWER

2 Label side upward

Disc tray

3 DISC SKIP

4 OPEN/CLOSE

5 Select the disc play mode (DISC MODE: SINGLE or ALL) while watching the display.

Shows the selected disc mode.

“SINGLE” mode: The unit will play a designated disc only.
“ALL” mode: The unit will play all discs in the tray in sequence.

6 PLAY/PAUSE

* If necessary, select a desired disc by using a **DISC-select** button or the **DISC SKIP** button.

Notes

- After closing the disc tray by pressing the **OPEN/CLOSE** button in the stop mode or after selecting any disc by using the **DISC SKIP** button, the display shows the total number of tracks and the total recorded time of the disc to be played for a few seconds.

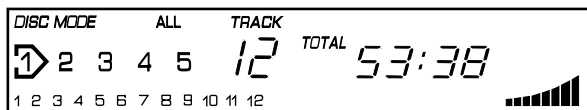

- Additionally, you can close the disc tray by pressing the **PLAY/PAUSE** button, a **DISC-select** button, a numeric button (on the remote control transmitter) or the **RANDOM** button, or by pressing the front edge of the disc tray gently. If the tray is closed in these ways, play will begin automatically, however, the display will not show the total number of tracks and the total recorded time of the first disc to be played.

PLAYXCHANGE

During play, you can open the disc tray by pressing the **PLAYXCHANGE** button without interrupting disc play. However, in this case, pressing the **DISC SKIP** button has no effect.

To stop play temporarily

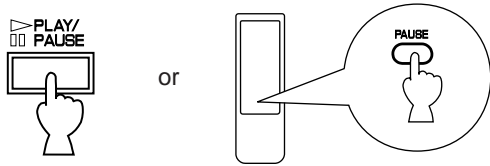

To stop play completely

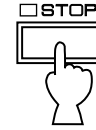

* To resume play, press the **PLAY/PAUSE** button again (or press the **PLAY** or **PAUSE** button on the remote control transmitter).

To play a desired track on the disc

DIRECT PLAY

Select a desired track by using the numeric buttons on the remote control transmitter.

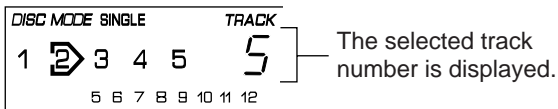
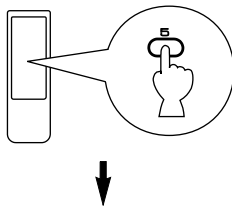

Example: To select track 25
Press ① twice, then immediately press ② once.

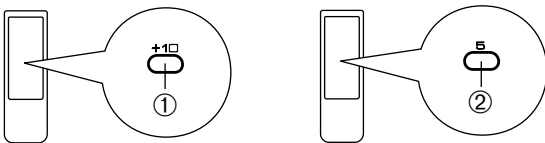

* If a track number higher than the highest track number on the disc is selected, the last track on the disc will be played.

SKIP PLAY

• To play from the beginning of the track following the one now playing

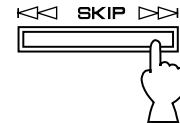

• To play from the beginning of the track now playing

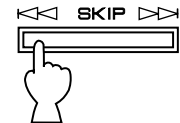

• To play from the beginning of the track before the one now playing

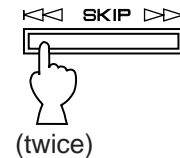

* These operations can also be performed when the unit is in the pause or stop mode.

Display information at disc play

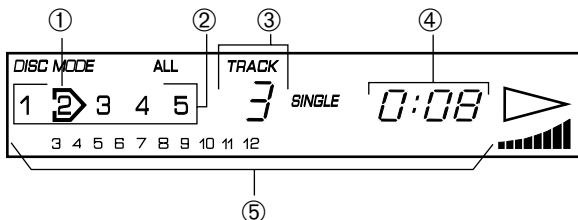

- ① Encloses the tray number of the disc standing by to be played or the disc now playing.
- ② Shows the tray numbers with discs.
- ③ Shows the track number to be played.
- ④ Shows the time displays. (Refer to "Selecting time displays" on the next page.)
- ⑤ Displays the numbers that correspond to the numbers of the tracks (as high as number 20) on the disc. After each track is played, its corresponding number disappears so the number of remaining tracks (and their numbers) can be seen at a glance.

To advance or reverse play rapidly (MANUAL SEARCH)

To advance rapidly

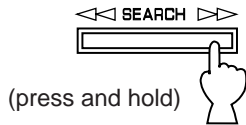

- The sound can be heard (although slightly garbled) during manual search in either direction. This is convenient for locating a precise position within a track, or for reviewing the contents quickly.
- Manual search can also be performed while disc play is paused, though no sound will be heard.

To reverse rapidly

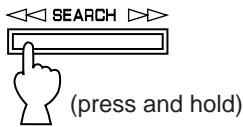

Selecting time displays

You can select any of the four time displays by pressing the **TIME** display mode-select button.

- ① Elapsed time of the track now playing

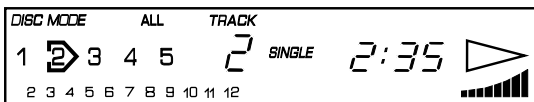

- ④ Total remaining time on the disc

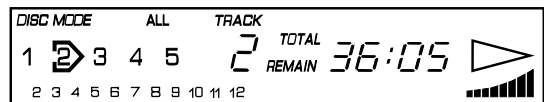

- ② Remaining time of the track now playing

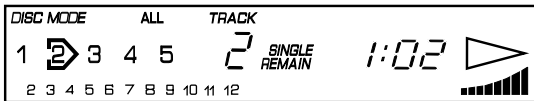

- ③ Total disc play time

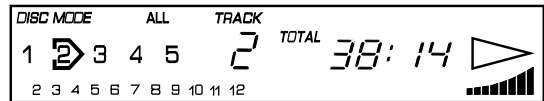

Notes

- The remaining time ② will not be displayed for track number 21 or higher.
- You can also select one of the three levels of brightness of the display by pressing the **DIMMER** button.

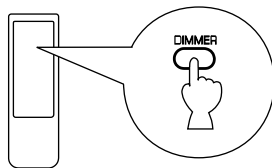

When you listen with headphones

Connect the headphones to the **PHONES** jack and adjust the volume by using the **OUTPUT LEVEL** control. At that time, note that this adjustment will also vary the level of the signal output to the amplifier.

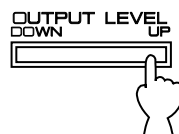
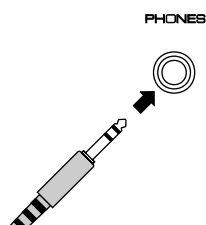

OR

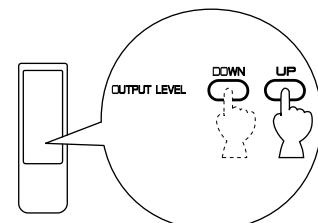

RANDOM-SEQUENCE PLAY

You can play the tracks in a random sequence (up to 99 tracks). The unit will automatically mix up tracks from all discs or any desired disc in the disc tray.

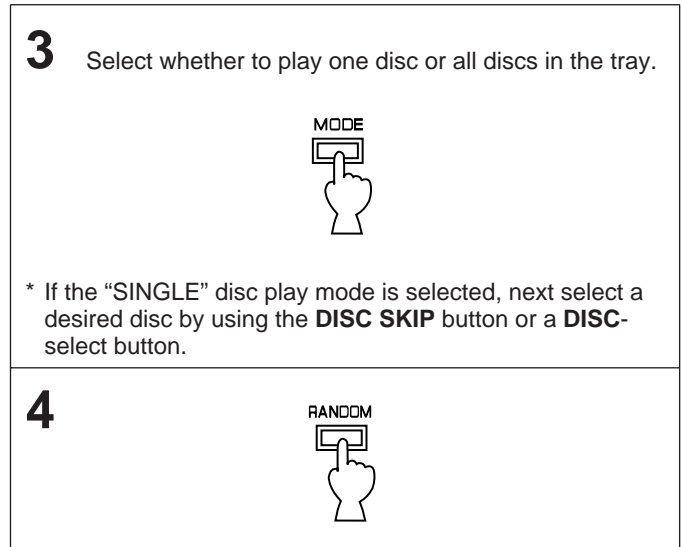
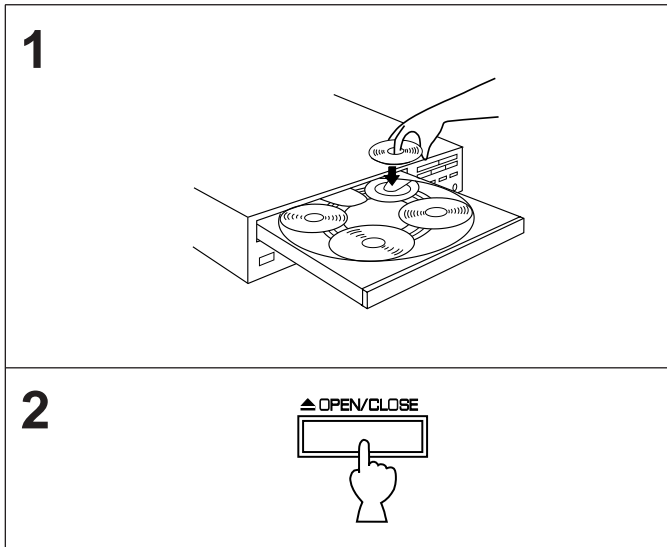
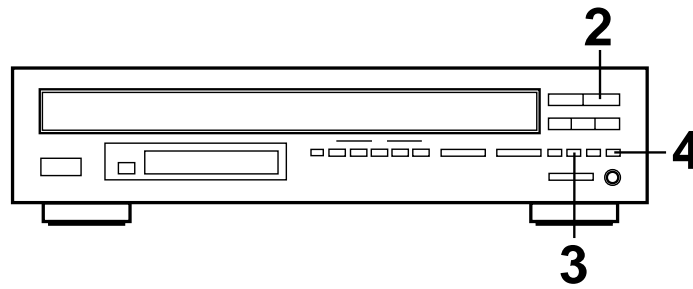

To cancel random-sequence play

Press the **STOP** button or **RANDOM** button once again, or open the disc tray by pressing the **OPEN/CLOSE** button.

Notes

- This feature will not function during programming, or during programmed play.
- If the **POWER** switch is set off when the random-sequence play mode is functioning, when the **POWER** switch is set on again, the unit will begin the random-sequence play automatically. (This feature is available for the timer play.)
- If the **SKIP** $\triangleright\triangleright$ button is pressed during random-sequence play, the next randomly programmed track will be played. If the **SKIP** $\triangleleft\triangleleft$ button is pressed, play will return to the beginning of the track now being played.
-  This indication appears while the unit is mixing up tracks.
- Total remaining time on the disc will not be displayed during random-sequence play.

PROGRAM PLAY

You can enjoy listening to your favorite tracks selected from one or plural discs in any desired order using a programmed play.

* The use of the remote control transmitter is recommended for easier operations.

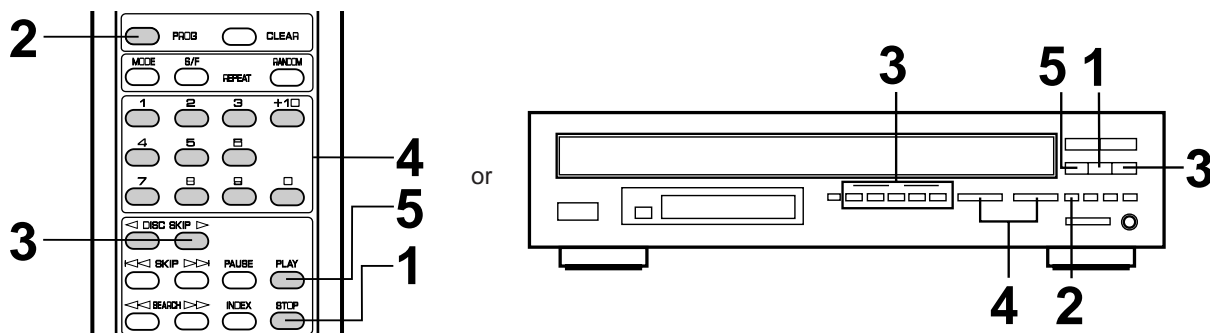

1 Stop the unit.

2

3 If necessary, select the desired disc.

4 Select the desired track.

(Select a track number.)

(Press once.)

*Repeat steps 3 and 4 to set more programs.

5 When the programming is completed;

Display information during program play

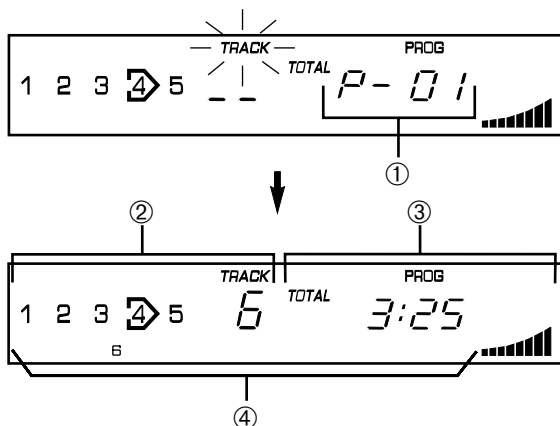

- ① Shows the program number for the track to be set next.
 - ② Shows the selected disc and track number.
 - ③ Shows the total time of the tracks currently programmed, if tracks are selected from one disc only.
 - ④ Shows only the numbers of programmed tracks.
- * If "P-01" does not appear in the display after the **PROG** button is pressed, press the **TIME** display mode-select button.
- * If the total time reaches 100 minutes or more, only the last two-digits will be displayed for the three-digit number.

Notes

- You can set as many as 20 programs at a stretch.
- If you will make program setting with the DISC 1 tray empty, be sure to press the **DISC SKIP** button before starting program setting.
- The total time of the programmed tracks will not be displayed, if tracks are selected from more than one disc.
- The total time of the programmed tracks will not be displayed, if the number of track higher than 20 is programmed.
- If, during program setting, the **TIME** display mode-select button is pressed, the program number display can be changed to display the total time of the programmed tracks or no information. To return to the previous display, press the **TIME** display mode-select button once again.
- The **SKIP** (◀◀ and ▶▶) button can be used during playing, but only within the range of the programmed tracks.
- The **SEARCH** (◀◀ and ▶▶) button can be used during playing to search through all tracks, including unprogrammed tracks.

To stop program play

- Press the **STOP** button. The first track number programmed will be displayed.
- To resume play, press the **PLAY/PAUSE** button. Play will begin from the beginning of the program.

To cancel a programmed setting

There are several methods, as described below.

- Press the **CLEAR** button on the remote-control transmitter while the unit is stopped.
- Press the **STOP** button while the unit is stopped.
- Open the disc tray.
- Switch off the power.

To check programmed data

1. If the unit is in the play mode, press the **STOP** button.
2. Press the **PROG** button.
3. Each time the **SKIP** ▶▶ button is pressed, the track numbers and sequential order of the programmed tracks can be checked one after another. The display of the track number can be returned (sequentially in reverse order) by pressing the **SKIP** ◀◀ button.

To correct programmed data

1. Follow the procedure described in "To check programmed data".
2. Display the track number to be corrected by pressing the **SKIP** button.
3. Press a numeric button on the remote control transmitter to select a track to replace the one displayed. The previously programmed track will be cleared from the memory and the new one will be programmed.
4. After the correction has been completed, press the **PROG** button or **PLAY/PAUSE** button once again.

REPEAT PLAY

You can play any desired track or disc (set of discs) repeatedly by pressing the **REPEAT** button. The repeat play mode will change whenever you press the **REPEAT** button.

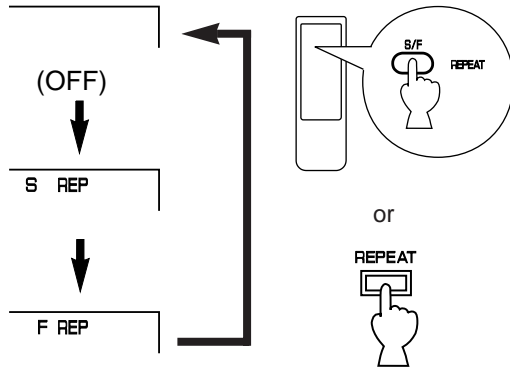

SINGLE REPEAT (S REP)

A single track is repeatedly played.

* This is also available in the programmed-play mode and the random-sequence play mode. (If the repeat play mode is switched off, the programmed-play mode or the random-sequence play mode will be resumed.)

FULL REPEAT (F REP)

In the "SINGLE" disc play mode: A designated disc is played repeatedly.

In the "ALL" disc play mode: All discs in the disc tray are repeatedly played.

* In the programmed-play mode, all programmed tracks are repeatedly played.

* In the random-sequence play mode, all randomly sequenced tracks are repeatedly played in the same order.

INDEX SEARCH

If the disc includes index numbers, play can be started from any desired index number.

- 1 Select a track which has index numbers.

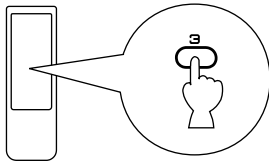

- 2

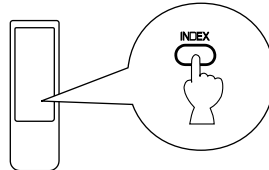

- 3 Select the desired index number.

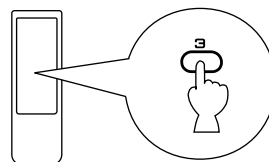

To cancel the index search function

Press the **INDEX** button.

Notes

- Not all discs have index numbers. The index system is a method for sub-dividing tracks into smaller divisions (such as, for example, the movements within classical symphonies) for easier location of those parts. The liner notes with the disc usually tell if such index numbers are included.
- If an index number is selected that is higher than any index number on that disc, play will start from the last index number point on the disc.
- For some discs, play may begin slightly prior to the actual designated index point.
- If the disc has no encoded index points, play will begin from the start of the selected track.
- The index number can be designated only while the INDEX number display is illuminated.

NOTES ABOUT THE REMOTE CONTROL TRANSMITTER

Battery installation

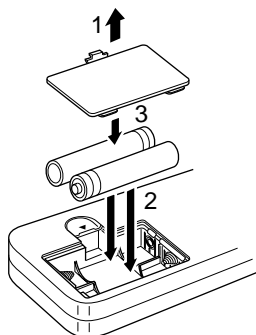

Battery replacement

If you find that the remote-control transmitter must be used closer to the main unit, the batteries are weak. Replace both batteries with new ones.

Notes

- Use only "AA" (R6) batteries for replacement.
- Be sure the polarities are correct. (See the illustration inside the battery compartment.)
- Remove the batteries if the remote-control transmitter will not be used for an extended period of time.
- If batteries leak, dispose of them immediately. Avoid touching the leaked material or letting it come in contact with clothing, etc. Clean the battery compartment thoroughly before installing new batteries.

Remote-control transmitter operation range

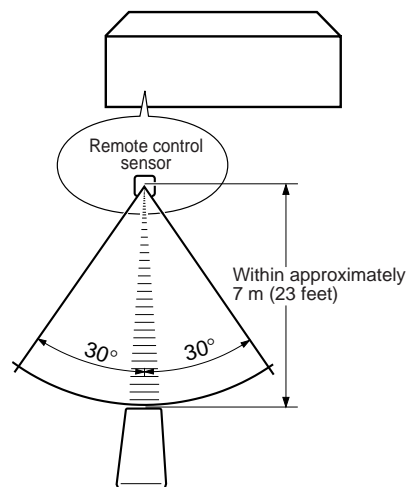

Notes

- There should be no large obstacles between the remote-control transmitter and the main unit.
- If the remote control sensor is directly illuminated by strong lighting (especially an inverter type of fluorescent lamp etc.), it might cause the remote-control transmitter to not work correctly. In this case, reposition the main unit to avoid direct lighting.

NOTES ABOUT HANDLING COMPACT DISCS

- This compact-disc player is designed only for playing of compact discs bearing the  mark. Never attempt to load any other type of disc into the unit. The unit will also play 3-inch (8-cm) compact discs.
- To remove a disc from its storage case, open the case and then press down at the center; with a finger through the center hole and the outer edges held as shown in the illustration, lift the disc out carefully.

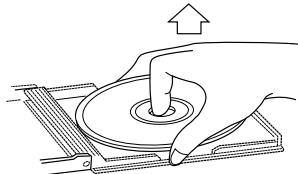

- Always handle the disc with care so that its surface is not scratched.

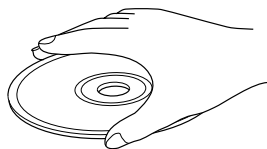

- Compact discs are not subjected to wear during play, but damage to the disc surface when the disc is being handled can adversely affect the disc's play.

- Compact discs are not affected by small particles of dust or fingerprints on their playing surface, but even so they should be kept clean. Wipe by using a clean, dry cloth. Do not wipe with a circular motion; wipe straight outward from the center.

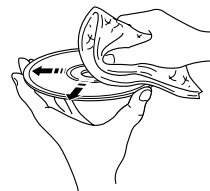

- Do not try to clean the disc's surface by using any type of disc cleaner, record spray, anti-static spray or liquid, or any other chemical-based liquid, because such substances might irreparably damage the disc's surface.
- Do not expose discs to direct sunlight, high temperature or high humidity for a long period of time, because these might warp or otherwise damage the disc.

NO!



To play a 3-inch (8-cm) CD

Place it in the inner recessed area of the disc tray. Do not put a normal (5-inch/12-cm) CD on top of a 3-inch CD.

TROUBLESHOOTING

If the unit fails to operate normally, check the following points to determine whether the problem can be corrected by the simple measures suggested. If it cannot, or if the problem is not listed in the SYMPTOM column, disconnect the unit's power cord and contact your authorized YAMAHA dealer or service center for assistance.

SYMPTOM	PROBABLE CAUSE	REMEDY
The player does not switch ON when the POWER switch is pressed.	The power cord is not connected or not completely connected.	Securely connect the power cord.
The disc tray does not close completely.	A foreign object is obstructing the tray.	Carefully check the disc tray and remove the foreign object.
A disc number does not illuminate in the display.	The disc has been loaded upside down.	Load the disc correctly.
	The disc is damaged.	Check the disc carefully; replace it if necessary.
	There is moisture on the laser pickup.	Wait 20 to 30 minutes after switching the unit ON before trying to play a disc.
Play does not begin.	The disc has been loaded upside down.	Reload the disc with the label side up.
	The disc is dirty.	Clean the disc.
Play is delayed, or begins at the wrong place.	The disc may be scratched or damaged.	Check the disc carefully; replace it if necessary.
No sound.	Improper output cable connections.	Connect the cables properly. If the problem persists, the cables may be defective.
	Improper amplifier operation.	Set the amplifier controls to the correct input selection.
Sound "skips".	The player is being subjected to vibrations or impacts.	Relocate the player.
	The disc is dirty.	Clean the disc.
Sound "hums".	Improper cable connections.	Securely connect the audio cables. If the problem persists, the cables may be defective.
Noise from a nearby tuner.	The tuner is too close to the player.	Move the tuner and player farther apart.
Noise from inside of the disc tray.	The disc may be warped.	Replace the disc.
The remote-control transmitter does not work.	Direct sunlight or lighting (of an inverter type of fluorescent lamp etc.) is striking the remote control sensor of the main unit.	Change position of the main unit.

SPECIFICATIONS

AUDIO SECTION

Frequency response 2 Hz – 20 kHz, +0.5 / -1 dB
De-emphasis equalization ±0.5 dB
Harmonic distortion+noise (with L.P.F.) Less than 0.004% (1 kHz)
S/N ratio 108 dB
Dynamic range 98 dB
Wow & flutter Unmeasurable
Output voltage 2±0.5V
Headphones output (-20 dB) 200 mV/150 ohms

GENERAL

Power requirements
U.S.A. and Canada models 120V, 60 Hz
Australia and U.K. models 240V, 50 Hz
Europe model 230V, 50 Hz
General model 110/120/220/240V, 50/60 Hz
Power consumption 20W
Dimensions (W x H x D) 435 x 107.5 x 387 mm
 (17-1/8" x 4-1/4" x 15-1/4")
Weight 6.2 kg (13 lbs. 10 oz.)
Accessories Connection cord
 Remote control transmitter
 Batteries (size "AA", R6)

Please note that all specifications are subject to change without notice.

YAMAHA

YAMAHA ELECTRONICS CORPORATION, USA 6660 ORANGETHORPE AVE., BUENA PARK, CALIF. 90620, U.S.A.
YAMAHA CANADA MUSIC LTD. 135 MILNER AVE., SCARBOROUGH, ONTARIO M1S 3R1, CANADA
YAMAHA ELECTRONIK EUROPA G.m.b.H. SIEMENSSTR. 22-34, D-25462 RELLINGEN BEI HAMBURG, F.R. OF GERMANY
YAMAHA ELECTRONIQUE FRANCE S.A. RUE AMBROISE CROIZAT BP70 CROISSY-BEAUBOURG 77312 MARNE-LA-VALLEE CEDEX02, FRANCE
YAMAHA ELECTRONICS (UK) LTD. YAMAHA HOUSE, 200 RICKMANSWORTH ROAD WATFORD, HERTS WD1 7JS, ENGLAND
YAMAHA SCANDINAVIA A.B. J A WETTERGRENS GATA 1, BOX 30053, 400 43 VÄSTRA FRÖLUNDA, SWEDEN
YAMAHA MUSIC AUSTRALIA PTY, LTD. 17-33 MARKET ST., SOUTH MELBOURNE, 3205 VIC., AUSTRALIA

YAMAHA CORPORATION
VM62150-3 Printed in Japan BWWR, Y

Free Manuals Download Website

<http://myh66.com>

<http://usermanuals.us>

<http://www.somanuals.com>

<http://www.4manuals.cc>

<http://www.manual-lib.com>

<http://www.404manual.com>

<http://www.luxmanual.com>

<http://aubethermostatmanual.com>

Golf course search by state

<http://golfingnear.com>

Email search by domain

<http://emailbydomain.com>

Auto manuals search

<http://auto.somanuals.com>

TV manuals search

<http://tv.somanuals.com>