

# YAMAHA

# KX-W592

# KX-W492

# KX-W392

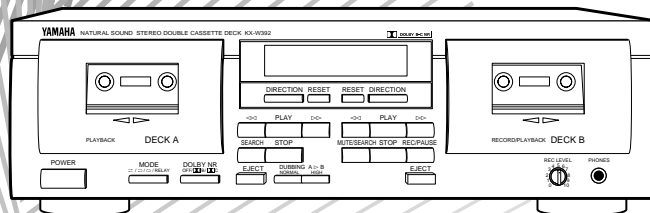
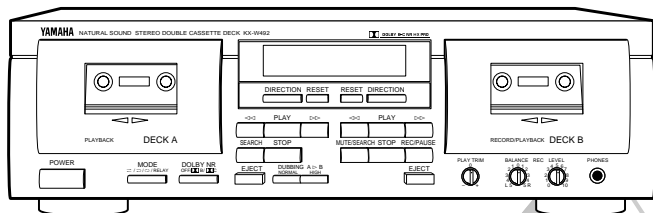
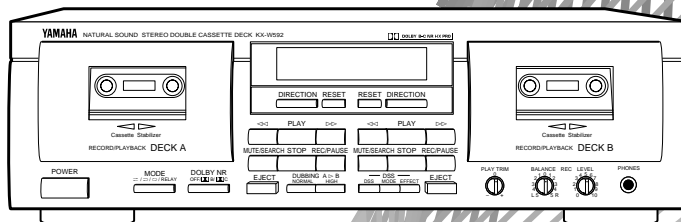

*Natural Sound Stereo Cassette Deck*

*Platine à cassette stéréo de la série "Natural Sound"*

*"Natural Sound" Stereo-Doppelkassettengerät*

*Natural Sound stereokassettdäck*

*Registratore a doppia cassette stereo a suono naturale*

*Magnetófono estéreo de dos de sonido natural*

*Stereo-cassettedeck voor een "natuurlijk geluid"*

OWNER'S MANUAL  
MODE D'EMPLOI  
BEDIENUNGSANLEITUNG  
BRUKSANVISNING  
MANUALE DI ISTRUZIONI  
MANUAL DE INSTRUCCIONES  
GEBRUIKSAANWIJZING

## CAUTION: READ THIS BEFORE OPERATING YOUR UNIT.

1. This unit is a sophisticated stereo cassette deck. To ensure proper operation for the best possible performance, please read this manual carefully.
2. Choose the installation location of your unit carefully. Avoid placing it in direct sunlight or close to source of heat. Also avoid locations subject to vibration and excessive dust, heat, cold or moisture. Keep it away from sources of hum such as transformers or motors.
3. Do not open the cabinet as this may result in damage to the deck or electrical shock. If a foreign object should get into the deck, contact your local dealer.
4. When removing the power plug from the wall outlet, always pull directly on the plug; never pull the cord itself.
5. Do not apply excessive force when operating switches and knobs.
6. When moving the deck, be sure to first pull out the power plug and remove all cords connecting the deck to other equipments.
7. Do not attempt to clean this unit with chemical solvents as this may damage the finish. Use a clean, dry cloth.
8. Never allow metallic items (e.g. screwdrivers, tools, etc.) to come near the record/playback head assembly. Doing so may not only scratch or damage the head's mirror-smooth finish, but also change the magnetic characteristics of the heads, causing a deterioration in reproduction quality.
9. Although the record/playback head used in this unit is a high quality head with outstanding reproduction characteristics, it can become dirty through the use of old tapes or from dust accumulation over time. This can have a serious effect on reproduction quality.  
Clean the heads regularly with one of the commonly available head cleaners or with cleaning solutions as explained later in this manual.
10. Be sure to read the "Troubleshooting" section of this manual for advice on common operating errors before concluding that your unit is faulty.
11. Keep this manual in a safe place for future reference.
12. **Voltage Selector (General Model only)**  
**The voltage selector on the rear panel of this unit must be set for your local mains voltage BEFORE plugging in the AC mains supply.**

Please check the copyright laws in your country to record from records, compact discs, radio, etc. Recording of copyright material may infringe copyright laws.

**WARNING**  
TO REDUCE THE RISK OF FIRE OR ELECTRIC SHOCK, DO NOT EXPOSE THIS APPLIANCE TO RAIN OR MOISTURE.

**CAUTION**  
The apparatus is not disconnected from the AC power source as long as it is connected to the wall outlet, even if the apparatus itself is turned off.

### For U.K. customers

If the socket outlets in the home are not suitable for the plug supplied with this appliance, it should be cut off and an appropriate 3 pin plug fitted. For details, refer to the instructions described below.

**Note:** The plug severed from the mains lead must be destroyed, as a plug with bared flexible cord is hazardous if engaged in a live socket outlet.

### Special Instructions for U.K. Model

**IMPORTANT**  
The wires in the mains lead are colored in accordance with the following code:

Blue: NEUTRAL  
Brown: LIVE

As the colors of the wires in the mains lead of this apparatus may not correspond with the colored markings identifying the terminals in your plug, proceed as follows. The wire which is colored BLUE must be connected the terminal which is marked with the letter N or colored BLACK. The wire which is colored BROWN must be connected to the terminals which is marked with the letter L or colored RED.  
Making sure that neither core is connected to the earth terminal of the three pin plug.

**CAUTION (For Canada model)**  
TO PREVENT ELECTRIC SHOCK, MATCH WIDE BLADE OF PLUG TO WIDE SLOT, FULLY INSERT.

THIS DIGITAL APPARATUS DOES NOT EXCEED THE "CLASS B" LIMITS FOR RADIO NOISE EMISSIONS FROM DIGITAL APPARATUS SET OUT IN THE RADIO INTERFERENCE REGULATIONS OF THE CANADIAN DEPARTMENT OF COMMUNICATIONS.

## TABLE OF CONTENTS

FEATURES .....	3	RELAY RECORDING (KX-W592 only) .....	14
CONNECTIONS .....	4	DUBBING .....	15
NOTES ON THIS MANUAL .....	4	CASSETTE TAPES .....	16
PLAYBACK .....	5	MAINTENANCE .....	17
Basic operation .....	5	OPTIONAL REMOTE CONTROL TRANSMITTER .....	17
SELECTION SEARCH .....	7	TROUBLESHOOTING .....	18
RELAY PLAYBACK .....	8	SPECIFICATIONS .....	19
PLAY TRIM control adjustment (KX-W592 and KX-W492 only) .....	8		
DIGITAL SUPER SURROUND (DSS) (KX-W592 only) .....	9		
RECORDING .....	10		
Basic operation .....	10		
REC MUTE operation .....	12		
REC RETURN operation .....	12		
DUAL RECORDING (KX-W592 only) .....	13		

## FEATURES

- High Quality Hard Permalloy Recording/Playback Head in Both Decks (KX-W592 only)
- High Quality Hard Permalloy Recording/Playback Head in Deck B and Playback Head in Deck A (KX-W492 and KX-W392 only)
- Secure Holding Damper Cassette Stabilizer allows you to reduce unwanted vibration and modulation noise (KX-W592 only)
- Dolby HX Pro Dynamic Bias Servo (KX-W592 and KX-W492 only)
- Dolby B/C Noise Reduction
- Digital Super Surround (DSS) Function enables you to create an excellent audio sound field, applicable also for recording (KX-W592 only)
- Play Trim Control for improved playback compatibility with other decks (KX-W592 and KX-W492 only)
- Auto Tape Selector
- Dual Recording allows you to make the same recording on both decks simultaneously (KX-W592 only)
- Relay Playback from DECK A to DECK B
- Relay Recording from DECK A to DECK B (KX-W592 only)
- Selection Search
- Recording Mute Function
- Rec Return Operation
- Easy Dubbing Operation at Selectable Speed (Normal/High)
- Peak Level Meters with Peak Hold Function
- Remote Control Capability with Optional Remote Control Transmitter

Dolby noise reduction and HX Pro headroom extension manufactured under license from Dolby Laboratories Licensing Corporation, HX Pro originated by Bang & Olufsen.

“DOLBY”, the double-D symbol  and “HX PRO” are trademarks of Dolby Laboratories Licensing Corporation.

# CONNECTIONS

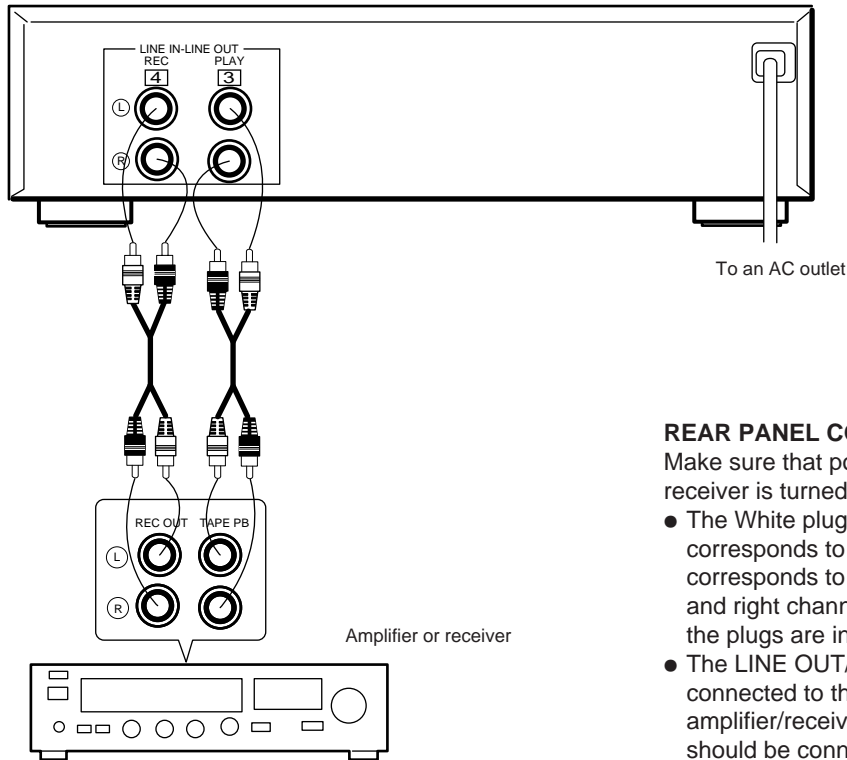

## REAR PANEL CONNECTIONS

Make sure that power to both the deck and your amplifier/receiver is turned off before making any connections.

- The White plug on the paired connecting cables corresponds to the Left channel and the Red plug corresponds to the Right channel. Make sure that the left and right channel connections are properly made, and that the plugs are inserted firmly.
- The LINE OUT/PLAY jacks on the deck should be connected to the Tape PB (Playback/Input) jacks on your amplifier/receiver, and the LINE IN/REC jacks on the deck should be connected to the Rec Out (Recording/Output) jacks on your amplifier/receiver.
- Connect the power cord to an AC wall outlet or to an AC outlet on the rear panel of your amplifier/receiver (if provided).

# NOTES ON THIS MANUAL

In this manual, the main operation buttons of the front panel are indicated based on DECK B when the operation is common to both DECKS A and B. Since the locations of the buttons of DECK B and DECK A are the same, you can easily find the desired button even when operating DECK A. This manual covers three models. In most cases, however, only model KX-W592 is shown in the example illustrations.

## Example: KX-W592

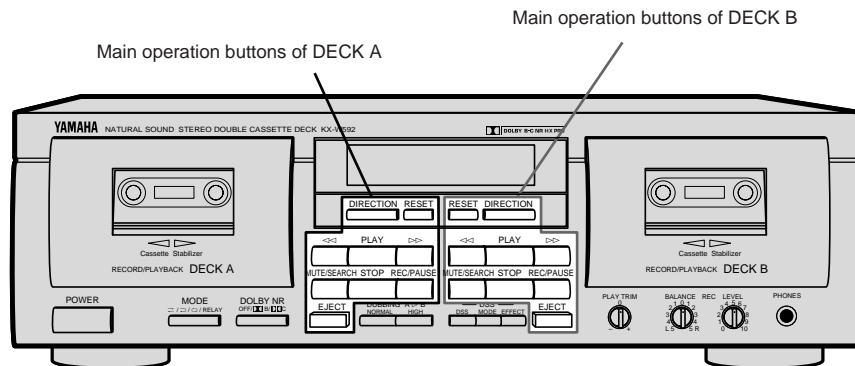

# PLAYBACK (Common to DECKS A and B)



## Preparation for playback

- Turn on the **POWER** switch.
- Set your amplifier or receiver to cassette deck function mode.

## Basic operation - To play back a cassette tape

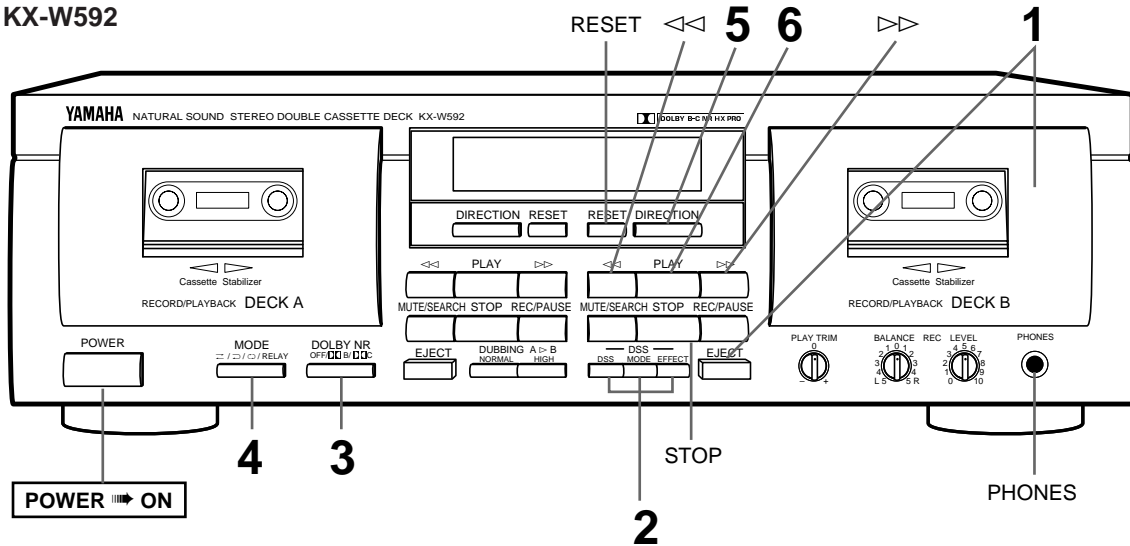
Example: KX-W592

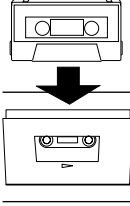
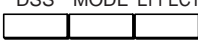
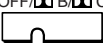

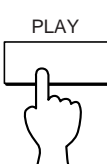
<p><b>1</b></p>   <p>Insert the cassette with the exposed tape side facing down. (The side facing you is called the forward side and the opposite side is called the reverse side.) To close the compartment, push in the compartment door until it locks shut.</p>	<p><b>2</b></p> <p><b>KX-W592</b> only</p>  <p>Refer to the following description.</p>	<p><b>3</b></p>  <p>Refer to the following description.</p>
<p><b>4</b></p>  <p>Refer to the following description.</p>	<p><b>5</b></p>  <p>Select the tape running direction for DECK A or B. Each time this button is pressed, the tape running direction changes between forward (&gt;) and reverse (&lt;), and the corresponding indicator lights on the display.</p>	<p><b>6</b></p> 

### To fast forward or rewind the tape

**When the tape running indicator > is lit:**

Pressing the >> button fast forwards the tape while pressing the << button rewinds the tape.

**When the tape running indicator < is lit:**

Pressing the << button fast forwards the tape while pressing the >> button rewinds the tape.

### To stop playback

Press the **STOP** button. To remove the cassette tape, press the **EJECT** button. The cassette compartment door opens. To turn off the power, press the **POWER** button.

### To set the counter reading to "0000"

Press the **RESET** button. Use the tape counter to aid in locating a point on a tape (0000 to 9999).

### DOLBY NR selector setting (in step 3)

Be sure to set the **DOLBY NR** selector according to the system used for recording.

**OFF**: For a tape recorded with DOLBY NR OFF.

**B**: For a tape recorded with DOLBY B NR.

**C**: For a tape recorded with DOLBY C NR.

### REVERSE MODE selector setting (in step 4)

The auto reverse function allows the tape running direction be reversed automatically. Select an auto reverse mode (  $\rightarrow$  ),  $\leftarrow$  RELAY ) or manual reverse mode (  $\rightarrow$  ).

$\rightarrow$ : When playback or fast forwarding (or rewinding) of one side of a tape is finished, the deck stops at the end of the tape.

$\rightarrow$ : Both sides of the tape are played back. After playing, the deck stops at the end of the tape. (When the tape running direction is set to  $\leftarrow$ , only the reverse side is played.)

$\leftarrow$  RELAY: Both sides of the tape are repeatedly played back (up to 8 times).

$\leftarrow$  RELAY: Cassette tapes loaded in DECKs A and B are played back sequentially. (See "RELAY PLAYBACK" on page 8.)

### Display during playback

The A or B indicator shown in the display represents the last deck operated.

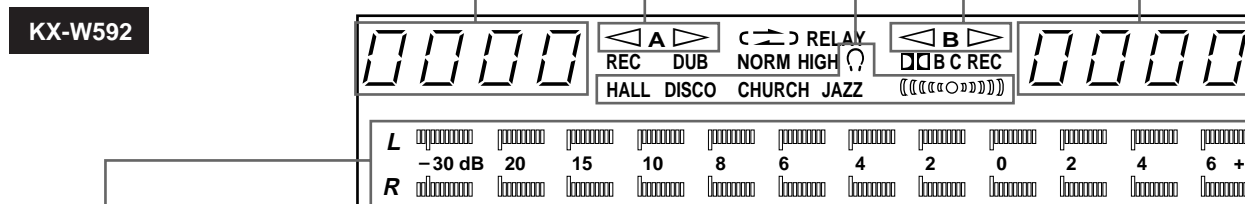

Peak level meters

Indicate the peaks of the signal levels during recording and playback over a -30 dB to +6 dB range. There are separate meters for each left and right channel. These level meters have a peak hold function which holds the peak level for about 1.5 seconds.

**KX-W492/  
KX-W392**

Displayed indicators represent the same functions as shown above.

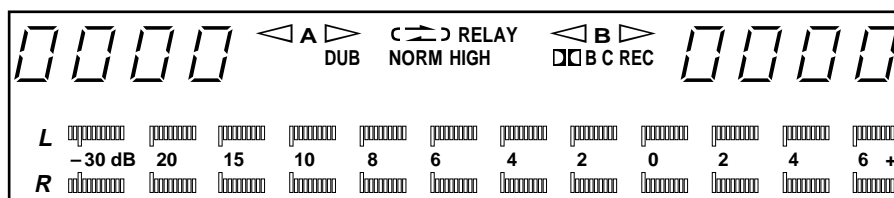

### To adjust the volume level

Use the volume control of the amplifier or receiver.

### Note

Never press the **EJECT** button during playback.

### To use headphones

Insert the headphones plug into the PHONES jack. Since the sound is also heard from the speakers, operate the amplifier to cut off the sound from the speakers for private listening.

Example: KX-W592

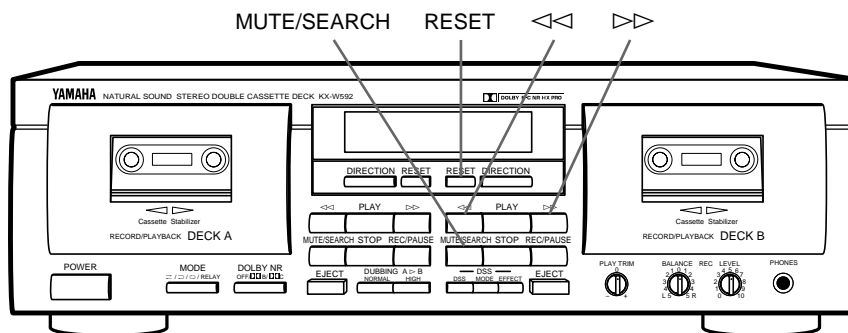

**SELECTION SEARCH - To play back a desired selection by searching for the beginning of the selection**

To search for the next selection

When the ▷ tape running indicator is lit:

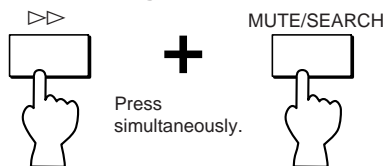

Press simultaneously.

When the ◁ tape running indicator is lit:

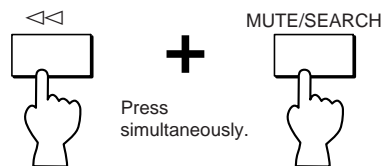

Press simultaneously.

To search for the beginning of the current selection

When the ▷ tape running indicator is lit:

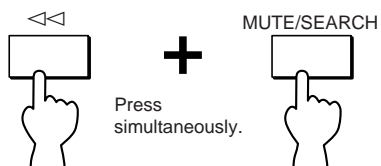

Press simultaneously.

When the ◁ tape running indicator is lit:

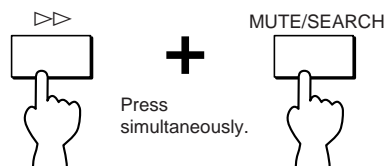

Press simultaneously.

To search for the selection located before the current selection

- Operate the following buttons when the beginning of the current selection is being played.

When the ▷ tape running indicator is lit:

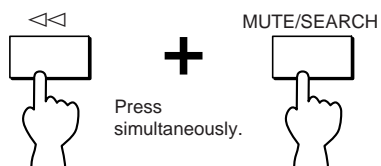

Press simultaneously.

When the ◁ tape running indicator is lit:

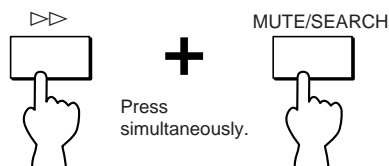

Press simultaneously.

**Notes**

- The blank interval between selections must be at least 4 seconds long.
- Selection search may not operate properly with tapes recorded at a low recording level or which have excessive noise.

**Example: KX-W592**

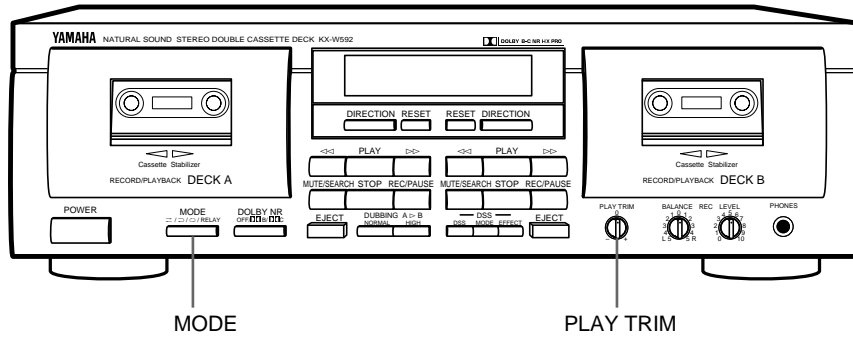

**RELAY PLAYBACK - To play DECK A and DECK B sequentially**

Load the cassette tapes into DECKS A and B, start playback from DECK A. The playback patterns differ according to the setting of the **MODE** button. Refer to the following.

<p><b>When the MODE button is set to  RELAY :</b>                  DECK A (forward side → reverse side) → DECK B (forward side → reverse side)                    Up to 8 times</p>	<p><b>Display</b></p>
<p><b>When the MODE button is set to :</b>                  DECK A (forward side → reverse side) \ DECK B (forward side → reverse side)                    Up to 8 times                      Up to 8 times</p>	
<p><b>When the MODE button is set to :</b>                  DECK A (forward side → reverse side) \ DECK B (forward side → reverse side)                  ● When the tape running direction is set to , only the reverse side is played.</p>	
<p><b>When the MODE button is set to :</b>                  DECK A (forward side or reverse side) \ DECK B (forward side or reverse side)</p>	

**PLAY TRIM control adjustment ( KX-W592 and KX-W492 only)**

When the level of high frequencies is either over emphasized or absent while playing a tape recorded on another cassette deck, adjust the high frequency response with the **PLAY TRIM** control.

When high frequencies are too loud, attenuate the high frequencies.



When high frequencies are too soft, boost the high frequencies.

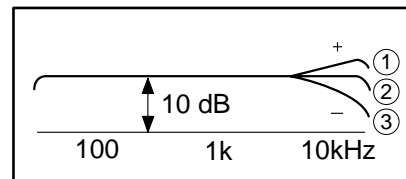
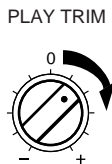

- ① High frequency sound is too loud.
- ② Flat
- ③ High-frequency sound is too soft.



**DIGITAL SUPER SURROUND (DSS) ( KX-W592 only)**

This unit incorporates a sophisticated, multi-program Digital Super Surround function, which allows you to expand and shape the audio sound field, for a theater-like experience in the listening room.

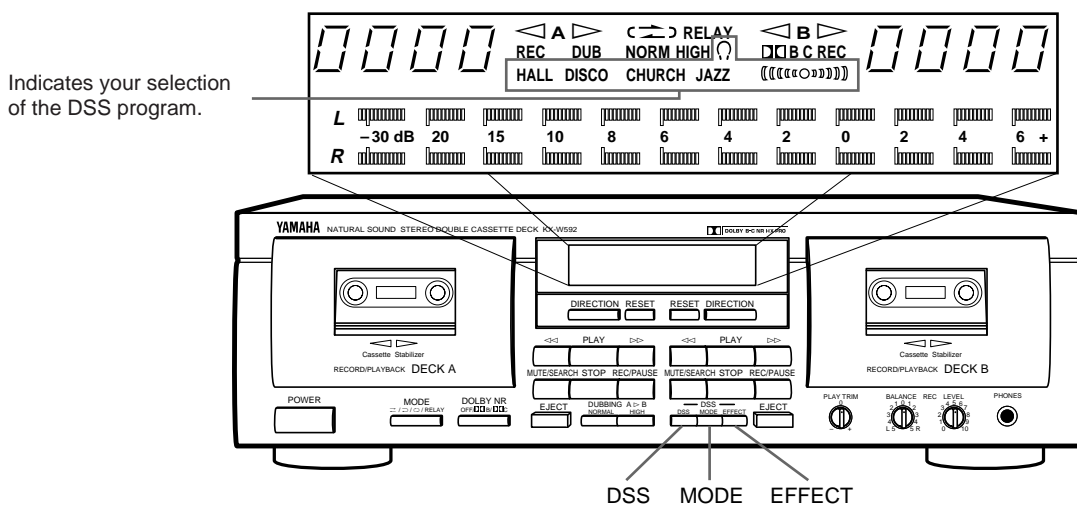

Indicates your selection of the DSS program.

Pressing the **DSS** button turns on and off the DSS effect.

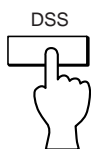

Adjust the level of effects by pressing the **DSS EFFECT** button.

- Effect level can be checked with the effect level indicator on the display.

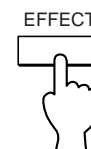

Each time the **DSS MODE** button is pressed, the DSS program changes in the following order and the corresponding indicator lights:

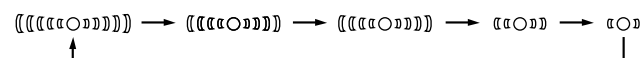
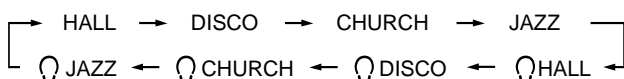
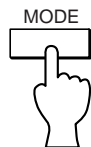

**Note**

When playing back a tape recorded with this unit using the DSS effect, be sure to turn off the DSS function. If the DSS is activated for playback too, the reproduced sound will be unnatural.

**DSS monitor function**

When the **DSS** button is pressed with any cassette inserted in neither of the decks, "dss" appears on the display in position of the tape counters of both decks.

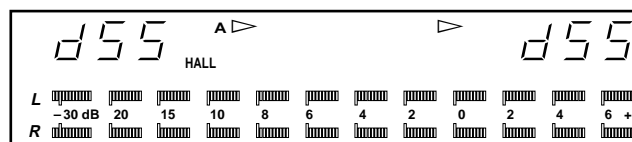

**Description of each Sound Field Program**

- : Programmed to provide largest sound field effects when listening through headphones.
- HALL** : A mode suitable for playing live recording of pop or rock concerts with vocals. The expansion and reverberation of concert hall are provided even when the speakers are installed close to each other.
- DISCO** : Crisp bass and solid, powerful sound reproduces the atmosphere of a disco.
- CHURCH** : Long echo time reproduces rich reverberation in a church. Suitable for vocal music.
- JAZZ** : A very rich presence is reproduced together with a three-dimensional feeling where each musical instrument asserts itself in the front line.

In this state, DSS effect can be applied to the input signal to the LINE IN jacks from any other source than cassette decks. The sound with DSS effect is output to the LINE OUT jacks.

- On the amplifier, select the source to apply the DSS effect with the REC OUT selector and set the input selector to the TAPE position. If the amplifier has no REC OUT selector, select the source with the input selector and set the amplifier to the TAPE MONITOR mode.
- Adjust the output level with the **REC LEVEL** control so that the reproduced sound is not distorted. For details, see "Setting the recording level" on page 12.

# RECORDING





## Preparation for recording

- Turn on the **POWER** switch.
- Set your amplifier or receiver to cassette deck function mode.

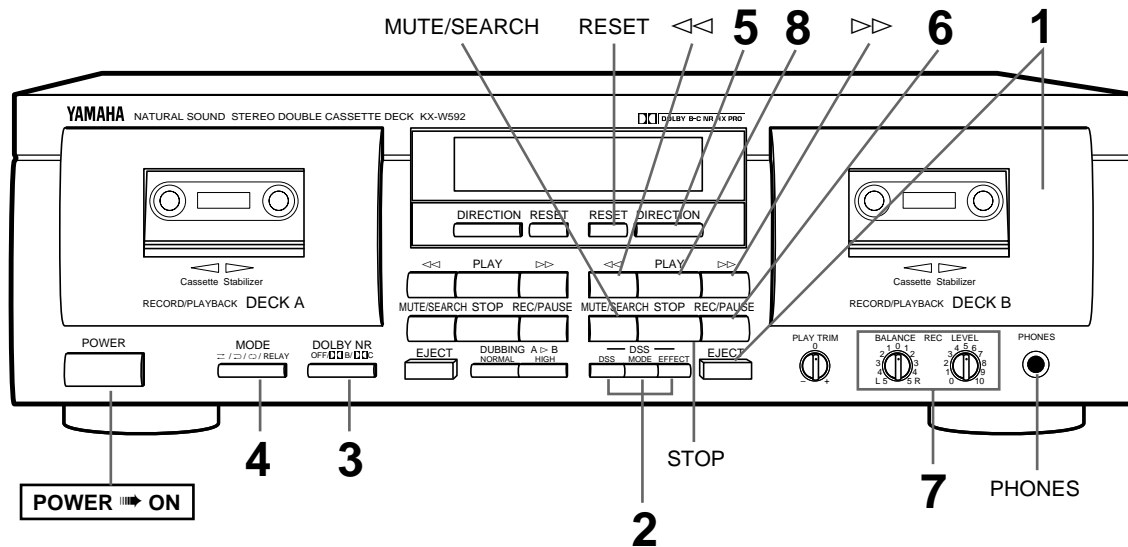
## Basic operation - To record a program source

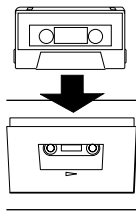
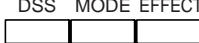
### Example: KX-W592

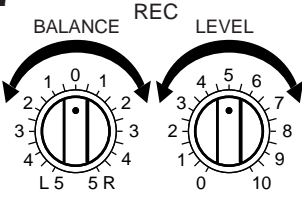
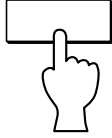

<p><b>1</b></p>   <p>Insert the cassette with the exposed tape side facing down. (The side facing you is called the forward side and the opposite side is called the reverse side.) To close the compartment, push in the compartment door until it locks shut.</p>	<p><b>2</b></p> <p><b>KX-W592</b> only</p>  <p>Refer to the following description.</p>	<p><b>3</b></p>  <p>Refer to the following description.</p>		
<p><b>4</b></p>  <p>Refer to the following description.</p>	<p><b>5</b></p>  <p>Select the tape running direction. (Press the <b>DIRECTION</b> button for DECK A (KX-W592 only) and the <b>DIRECTION</b> button for DECK B.) Each time one of these button is pressed, the tape running direction of the corresponding deck changes between forward (▷) and reverse (◁), and the indicator lights on the display.</p>	<p><b>6</b></p>  <p>The REC indicator lights on the display. The deck enters the rec pause mode.</p>	<p><b>7</b></p>  <p>Play the program source to be recorded and adjust the recording level and balance. (KX-W392 does not have a REC BALANCE control.)</p>	<p><b>8</b></p>  <p>Recording starts.</p>

**Digital Super Surround (DSS) setting (in step 2)  
(KX-W592 only)**

The DSS function can be utilized also for recording. Press the **DSS MODE** button to turn on the DSS function, and select one of the DSS programs by pressing the DSS button so that the corresponding indicator lights up. By recording with this function, you can enjoy the sources with your preferred DSS effect even when played back on car audios or portable headphone stereo systems. For details on DSS, see page 9.

**DOLBY NR selector setting (in step 3)**

Set the **DOLBY NR** selector according to your purpose.

**OFF:** No noise reduction.

**Ⓚ B:** For recording the sources with Dolby B NR.

**Ⓚ C:** For recording the sources with Dolby C NR.

- Dolby noise reduction is an extremely effective method of reducing undesirable background hiss on tapes. This unit incorporates both Dolby B NR and the newer Dolby C NR system. Dolby C NR is approximately twice as effective as the earlier Dolby B NR.

**REVERSE MODE selector setting (in step 4)**

The auto reverse function allows the tape running direction to be reversed automatically. Select the auto reverse mode (↔), manual reverse mode (↔) or the RELAY (KX-W592 only) recording mode.

↔: When recording on one side of a tape is finished, the deck stops at the end of the tape.

↔: Both sides of a tape are recorded. After recording, the deck stops at the end of the tape.

- When the tape running direction is set to ◀, only the reverse side is recorded.

- KX-W592

If you select ↔, the reverse mode automatically switches to ↔ in step 6.

If you select ↔ RELAY, the reverse mode automatically switches to ↔ RELAY in step 6.

- KX-W492 and KX-W392

If you select ↔ or ↔ RELAY, the reverse mode automatically switches to ↔ in step 6.

**Setting the recording level (in step 7)**

Play the loudest passage of the source to be recorded and watch the meter readings.

Adjust the **REC LEVEL** control so that the highest peak reaches +4 of the optimum recording level. Normally, it is best to adjust the **REC BALANCE** control (KX-W592 and KX-W492 only) such that the left and right meter readings are even.

**Display during recording**

The A or B indicator shown in the display represents the last deck operated.

**Tape counter**  
Use the tape counter to aid in locating a point on a tape (0000 to 9999). To set the counter reading to "0000", press the **RESET** button.

**KX-W592**

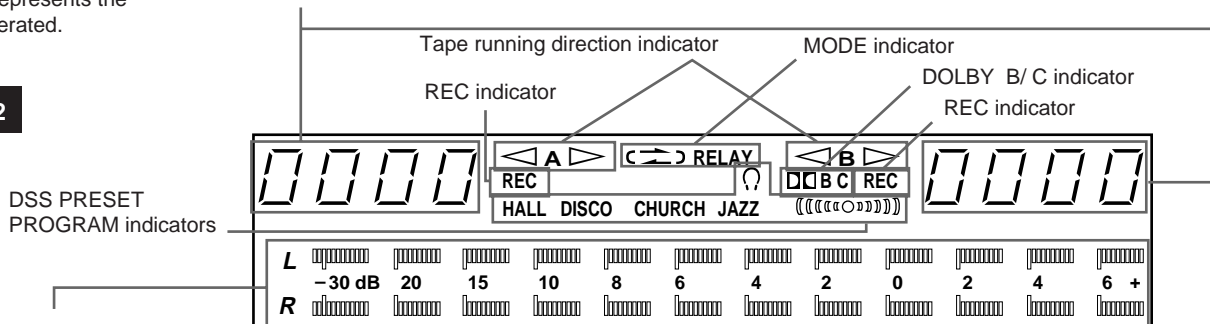

Indicate the peaks of the signal levels during recording and playback over a -30 dB to +6 dB range. There are separate meters for each left and right channel. These level meters have a peak hold function which holds the peak level for about 1.5 seconds.

**KX-W492/  
KX-W392**

Displayed indicators represent the same functions as shown above.

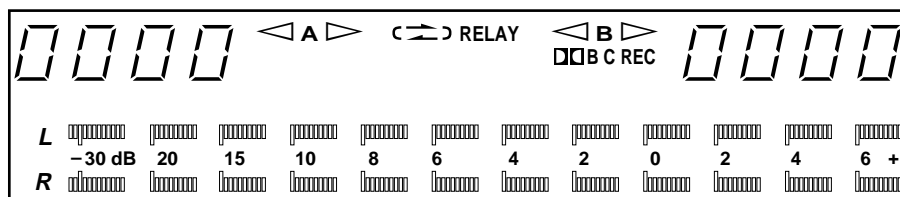

**To stop recording:**  
Press the **STOP** button.

**To stop recording temporarily:**  
Press the **REC/PAUSE** button. To resume recording, press the **PLAY** button.

## Example: KX-W592

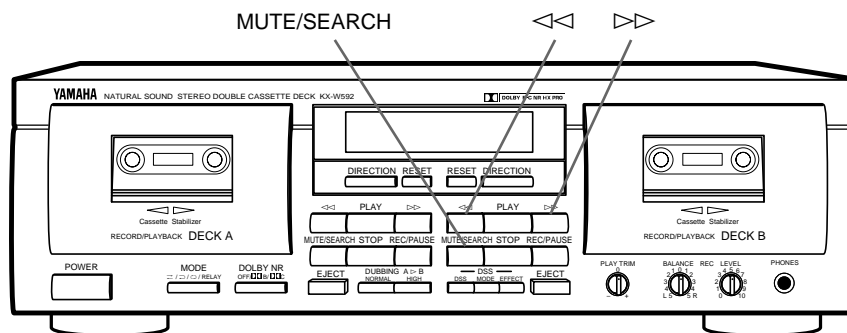

### REC MUTE operation - Inserting a blank space during recording

During recording:



During Rec mute operation, the REC indicator blinks.

A 4-second blank interval is automatically recorded on the tape and then the deck enters Rec pause mode. If a blank interval longer than 4 seconds is desired, keep pressing for as long as you want. When the **MUTE/SEARCH** button is released, the deck enters Rec pause mode after making a 4-second blank interval. To resume recording, press the **PLAY** button.

- If a blank interval shorter than 4 seconds is desired, press the **PLAY** button at the desired point during Rec mute mode. Recording will be resumed from that point.

### REC RETURN operation - To return to the point at which the recording started

During recording:

When the ▷ indicator is lit:



When the ◁ indicator is lit:



- If you press the **PLAY** button during recording, Rec Return automatically rewinds the tape to the point where the **PLAY** button was pressed. If you reset the tape counter to "0000" during recording, Rec Return automatically rewinds the tape to the "0000" point. Rec Return functions according to the most recent operation. For example, if you reset the tape counter to "0000" and then press the **PLAY** button later, Rec Return rewinds to the point where the **PLAY** button was pressed.

#### Synchronized recording function

When operating this unit in combination with the YAMAHA CD Player which has SYNCHRO button on its remote control transmitter, CD Synchronized recording function can be utilized. This function is operated with the remote control transmitter of the CD Player. (Regarding the operation, refer to the manual of the CD Player.)

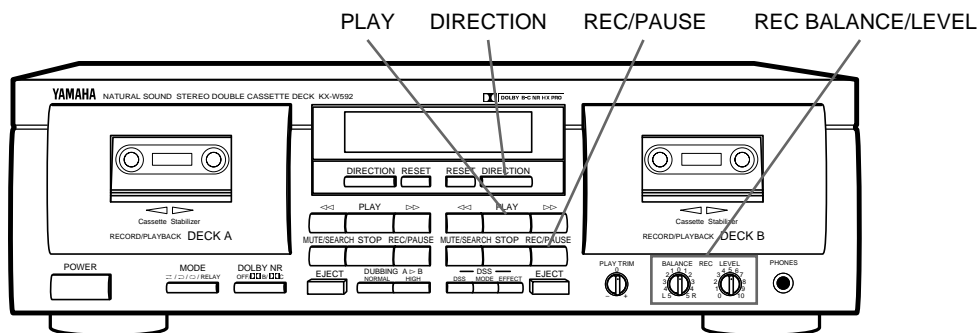

**DUAL RECORDING - To record a program source on both decks simultaneously ( KX-W592 only)**

To make the same tapes, use tapes of identical length.

- 1** Insert cassette tapes in both DECKs A and B.
- 2** Perform steps 2 through 4 of “Basic operation” to adjust the DSS, DOLBY NR and REVERSE MODE settings.  
For dual recording, Set the **MODE** selector to or position. If you select , the reverse mode automatically switches to in step 4. If you select RELAY , the reverse mode automatically switches to in step 7 (when you start to record). The DSS and DOLBY NR settings are the same for both DECK A and B.
- 3** Select the tape running direction for DECK A and B by pressing the **DIRECTION** buttons.



The tape running direction indicator of the corresponding deck (forward or reverse ) lights on the display.

- 4** Press the **REC/PAUSE** button on DECK A to enter the rec pause mode.

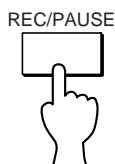

The REC indicator of the DECK A lights.

- 5** Press the **REC/PAUSE** button on DECK B to enter the rec pause mode.

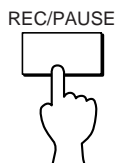

The REC indicator of the DECK B lights.

- 6** Play the program source to be recorded and adjust the recording level and balance.

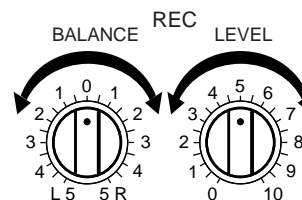

Recording level for both decks is adjusted to the same level.

- 7** To start recording, press the **PLAY** button on either DECK A or B.

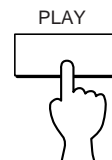

Both decks start recording simultaneously. Once the dual recording starts, pressing the **REC/PAUSE** or **STOP** button or performing the REC RETURN/REC MUTE operation on either DECK A or B affects both decks simultaneously.

**To stop recording in the middle of the tape**  
Press the **STOP** button for either DECKs A or B. Both decks will stop recording.

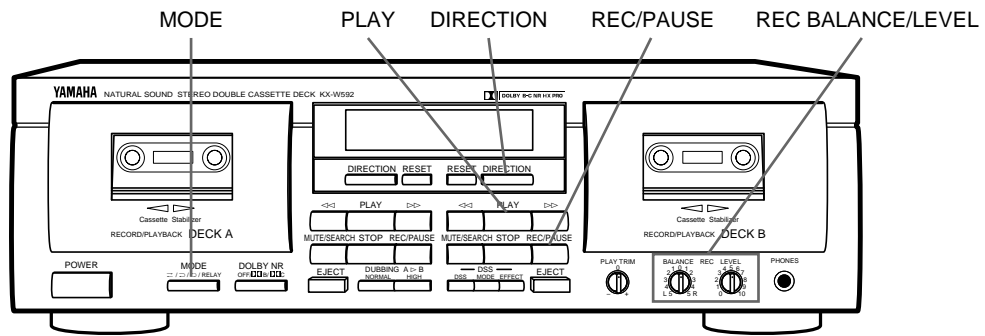

**RELAY RECORDING — To record a program source sequentially on DECK A and DECK B ( KX-W592 only)**

**Recording Pattern:**

DECK A (forward side → reverse side) → DECK B (forward side → reverse side)

Be sure to always start relay recording from the cassette in DECK A.

**1 Insert cassette tapes in both DECKs A and B.**

**2 Perform steps 2 and 3 of “Basic operation” to adjust the DSS and DOLBY NR settings.**  
The DSS and DOLBY NR settings are the same for both DECK A and B.

**3 Set the MODE selector to RELAY position.**



**4 Select the tape running direction each deck by pressing the DIRECTION button.**



The tape running direction indicator of the corresponding deck (forward ▷ or reverse ◁) lights on the display.

To record on both sides of the tapes, rewind them to the beginning of the forward side and select forward (▷) with the **DIRECTION** button respectively. When reverse (◁) is selected, the source is recorded only on the reverse side.

**5 Press the REC/PAUSE button on DECK A to enter the rec pause mode.**

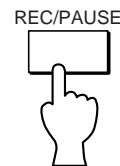

The REC indicator of the DECK A lights.

**6 Play the program source to be recorded and adjust the recording level and balance.**

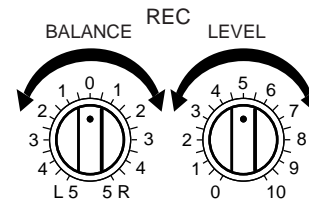

Recording level for both decks is adjusted to the same level.

**7 To start recording, press the PLAY button on DECK A.**

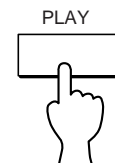

**DOLBY HX PRO DYNAMIC BIAS SERVO SYSTEM (KX-W592 and KX-W492 only)**

This unit incorporates the Dolby HX Pro system which automatically controls the effective bias to reduce distortion and noise, improving high frequency response during recording. Tapes recorded with this system retain the same high quality even when played back on any other cassette deck.

# DUBBING (From DECK A to DECK B)

You can make dubbing from DECK A to DECK B. Open the cassette compartments by pressing the **EJECT** buttons and load a blank cassette tape in DECK B and the original cassette tape in DECK A.

## Example: KX-W592

### Display during dubbing

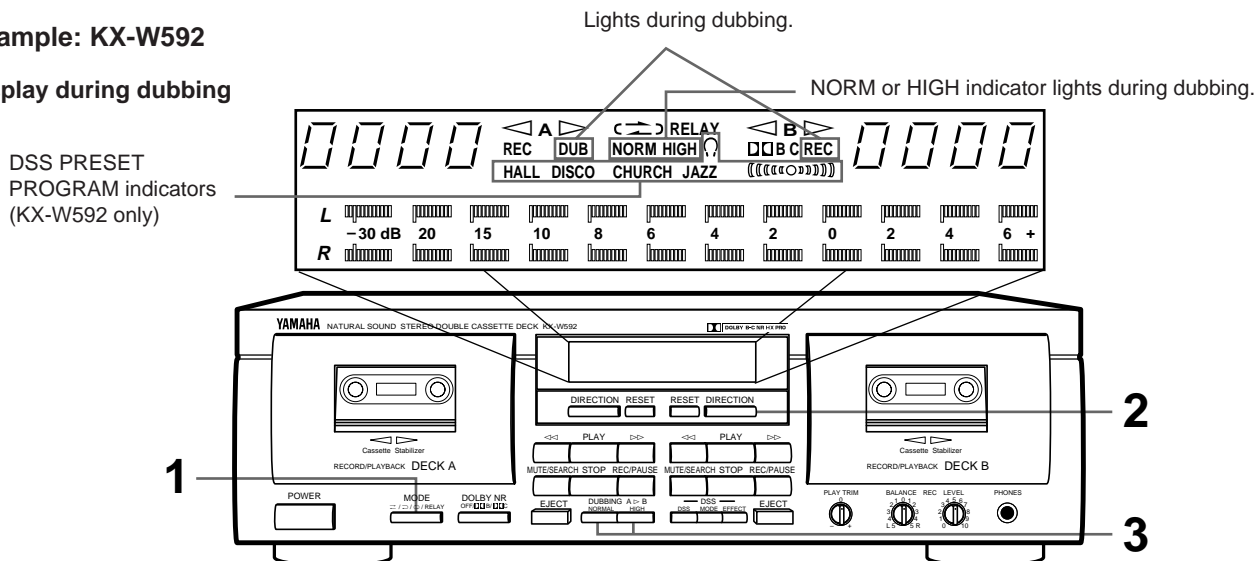

<p><b>1</b> Set the <b>MODE</b> selector to  or  position. Setting the <b>MODE</b> selector to  or  position results in the same function as to .</p>	<p><b>2</b> Set the <b>DIRECTION</b> buttons for <b>DECKs A and B</b>.</p>	<p><b>3</b> Set the <b>DUBBING</b> speed to either <b>NORMAL</b> (normal speed) or <b>HIGH</b> (twice the normal speed) with the <b>DUBBING</b> buttons*. Dubbing starts automatically.</p> <p>The corresponding <b>NORM</b> or <b>HIGH</b> indicator lights on the display.</p> <p>* Higher quality sound will be obtained with the <b>NORMAL</b> setting.</p>
-------------------------------------------------------------------------------------------------------------------------------------------------------	----------------------------------------------------------------------------	-----------------------------------------------------------------------------------------------------------------------------------------------------------------------------------------------------------------------------------------------------------------------------------------------------------------------------------------------------------------

### To stop dubbing

Press the **STOP** button. (If you press the **STOP** button on DECK B, both decks stop simultaneously and the dubbing mode is cancelled. If you press the **STOP** button on DECK A, DECK A stops immediately and then DECK B stops after recording a 4-second blank section.)

When the tape in DECK B reaches its end, DECK B and DECK A stop at the same time.

When the tape in DECK A reaches its end, DECK A stops and DECK B stops after providing a blank section of about 4 seconds.

### Available operations while dubbing

The Rec Return function can be carried out on DECK B. Refer to "REC RETURN operation" on the previous page.

### Note

During dubbing, the Dolby NR and the DSS (KX-W592 only) are automatically set to OFF and the recorded tape can be dubbed as it is. (When the tape to be dubbed is recorded with Dolby NR and/or DSS (KX-W592 only), these effects are also dubbed.)

### PLAY TRIM control adjustment

For normal use, set the **PLAY TRIM** control to the center position.

When the high frequencies sound is too noticeable or too weak while monitoring the sound of DECK B, compensate the high frequency response with the **PLAY TRIM** control before dubbing. The compensated sound can be dubbed onto DECK B.

As the compensation result depends on the quality of the tape loaded in DECK A, the monitored sound cannot be recorded as it is.

Refer to **PLAY TRIM** control adjustment on page 8.



# CASSETTE TAPES

## CASSETTE TAPES

There are many different types of cassette tapes available. However, they all conform to standard specifications so any brand may be used with the deck.

- **Classification of Cassette Tapes by Formulation:**

Cassette tapes are available in four basic types depending on their formulation, or type of magnetic material and manufacturing process. These four types are commonly known as Normal (Type I/NORM), Chrome (Type II/HIGH <math>\langle CrO\_2 \rangle</math>), Ferrichrome (Type III/FeCr), and Metal (Type IV/METAL), and they each require specific tape deck adjustments for optimum performance.

- \* YAMAHA does not recommend the use of 120 minute length cassettes since the extreme thinness of the tape makes them susceptible to mechanical and recording problems.

## AUTO TAPE SELECTOR DETECTION SLOTS

The deck has a built-in Auto Tape Selector which automatically adjusts for the proper bias, level and equalization according to the tape formulation — all you have to do is load a cassette and the Auto Tape Selector does the rest.

The Auto Tape Selector determines which type of tape is loaded by sensing detector slots in the top of the tape shell. Each tape formulation has its own characteristic hole markings standardized by the tape industry.

- Early model Metal (Type IV/Metal) tape formulation cassette shells do not have the slots for Auto Tape Selector operation. As a result, early model Metal type tapes recorded on another deck will be played back with the deck at the Chrome (Type II/HIGH <math>\langle CrO\_2 \rangle</math>) settings. YAMAHA does not recommend using this kind of tape.
- The deck does not have the required setting for Ferrichrome (Type III/FeCr) tape, since this tape formulation is not widely used. Should you use a Ferrichrome tape, it will be recorded and played back at the Normal (Type I/NORM) settings, which will result in an unnatural high frequency emphasis. This effect may be compensated for somewhat by adjusting the PLAY TRIM control and/or the tone controls of your amplifier/receiver during playback.

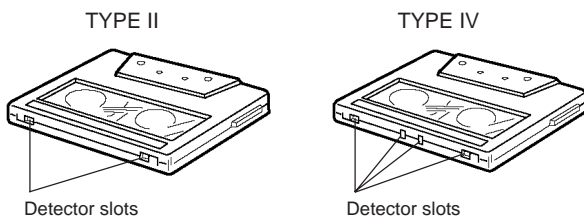

## PROTECTING YOUR RECORDINGS

All cassette tapes are provided with erasure protection holes to prevent accidental erasure of recorded contents. There is a small tab covering the hole on each side of the cassette, and it should be broken off after recording the tape. Without this tab covering the hole, it is impossible to record onto that tape. Thus, you can safely protect a recording for as long as you wish without fear of accidental erasure. Should you wish to use a cassette tape protected in this way for recording, simply covering the hole with adhesive tape will permit erasure and re-recording.

- When using Chrome (Type II/HIGH <math>\langle CrO\_2 \rangle</math>) or Metal (Type IV/METAL) tapes, make sure you do not cover the hole intended for the Auto Tape Selector operation.

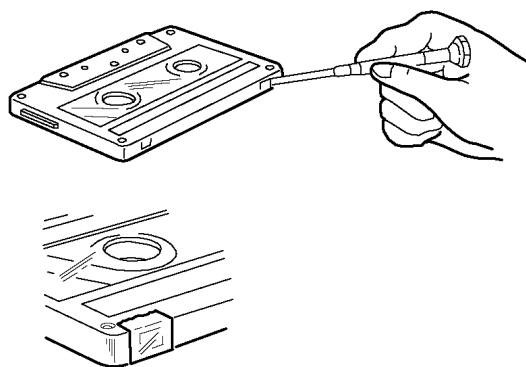

## TAKING UP SLACK IN THE TAPE

As a precaution against tape entanglement and damage, remove any slack in the tape before inserting cassettes into the deck. This is accomplished by inserting a pencil, pen or similar object into one of the spools and gently winding it until all the slack is removed. You do not have to wind it too tightly.

Be careful not to touch the tape part itself. It is very delicate and touching it may damage the tape and its recorded contents.

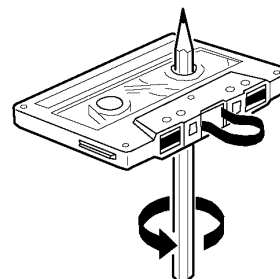

## STORING CASSETTES

After putting a cassette tape back into its case, store it in a location away from exposure to direct sunlight, humidity, high temperatures, and magnetic fields (away from television sets, speakers, etc.). High temperatures and humidity will damage the tape itself, while exposure to magnetic fields may cause a loss of recorded material. Avoid touching the tape surface with your fingers, since dirt or finger oil will contaminate the deck's heads.



# MAINTENANCE

## CLEANING OF THE TAPE PATH

Continued high quality performance of your deck is dependent upon periodic cleaning of the heads, capstan, pinch roller, and all surfaces over which the tape travels. Normal use will cause an accumulation of dirt and dust on the heads, capstans, and pinch rollers. This can lead to poor sound quality, drop outs (intervals with no sound), unsteady tape speed, loss of high frequency response, etc. Thus, clean the heads and all surfaces over which the tape travels with a commercially available cleaning cassette and fluid type cleaner.

## DECK B

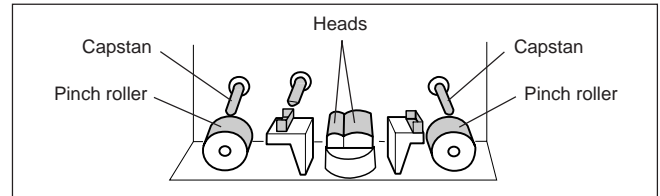

## DEMAGNETIZATION

After 20-30 hours of use, enough residual magnetism will build up on the heads to cause poor high frequency reproduction. At this time you should use a commercially available cassette tape-type head demagnetizer.

- When cleaning the tape path or demagnetizing the heads, be sure to follow carefully the instructions of the concerning materials such as cleaning fluid or head demagnetizer.

# OPTIONAL REMOTE CONTROL TRANSMITTER

With the optional remote control transmitter RS-KX1, you can operate this unit at your listening position. For details, refer to the instruction manual supplied with the remote control transmitter.

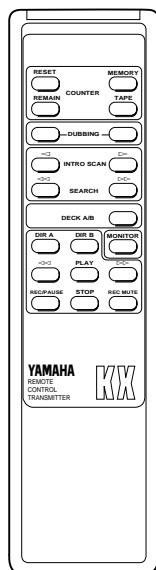

## REMOTE CONTROL OPERATION RANGE

Example: KX-W592

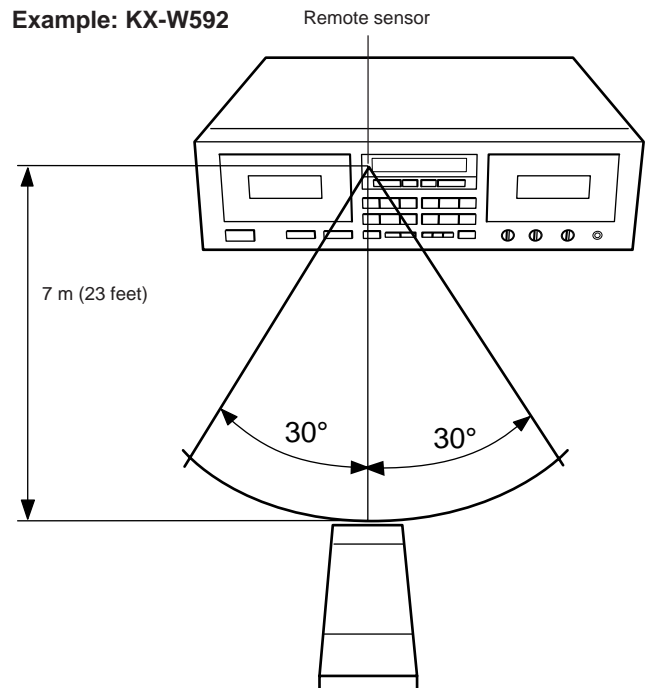

# TROUBLESHOOTING

If your cassette deck fails to operate normally, check the following table. It lists common operating errors and simple measures which you can take to correct the problem. If it cannot be corrected, or the symptom is not listed, disconnect the deck's power cord and contact your authorized YAMAHA dealer or authorized service center for help.

Fault	Cause	Cure
<b>Tape doesn't move in recording or playback.</b>	<ul style="list-style-type: none"> <li>● Power plug is not properly plugged in.</li> <li>● Cassette shell is warped or damaged.</li> </ul>	<ul style="list-style-type: none"> <li>● Reinsert plug properly.</li> <li>● Do not play damaged tapes.</li> </ul>
<b>REC/PAUSE button fails to function.</b>	<ul style="list-style-type: none"> <li>● No cassette tape loaded.</li> <li>● Protective tabs are broken off.</li> </ul>	<ul style="list-style-type: none"> <li>● Load a cassette tape.</li> <li>● Change tape or cover protective hole with adhesive tape.</li> </ul>
<b>Sounds become faint and sometimes inaudible.</b>	<ul style="list-style-type: none"> <li>● Head is dirty.</li> <li>● Head is magnetized.</li> <li>● Tape is damaged or of poor quality.</li> </ul>	<ul style="list-style-type: none"> <li>● Clean head.</li> <li>● Demagnetize head using head demagnetizer.</li> <li>● Change to a different tape.</li> </ul>
<b>Recorded sound is distorted.</b>	<ul style="list-style-type: none"> <li>● Tape is bad (stretched, deformed, etc.).</li> <li>● Cassette shell is warped.</li> <li>● Recording level is too high.</li> </ul>	<ul style="list-style-type: none"> <li>● Replace with a fresh tape.</li> <li>● A warped cassette shell cannot be fixed. Replace with another tape and test.</li> <li>● Check input level with signal level meter and use lower rec level when recording.</li> </ul>
<b>Tape is playing back, but no sound is heard.</b>	<ul style="list-style-type: none"> <li>● Faulty connection between deck and stereo amplifier/receiver.</li> </ul>	<ul style="list-style-type: none"> <li>● Check and secure connections.</li> </ul>
<b>Excessive noise.</b>	<ul style="list-style-type: none"> <li>● Head is dirty.</li> <li>● Head is magnetized.</li> <li>● Worn out or poor quality tape.</li> <li>● Connection(s) improperly made.</li> <li>● Affected by external electrical noise.</li> </ul>	<ul style="list-style-type: none"> <li>● Clean head.</li> <li>● Demagnetize head with head demagnetizer.</li> <li>● Change to better tape.</li> <li>● Check input and output connections and reinsert properly.</li> <li>● Move deck away from electrical appliances (TV, fluorescent light, electric blanket, etc.).</li> </ul>
<b>Excessive wow (wavering of the sound).</b>	<ul style="list-style-type: none"> <li>● Dirty capstan, pinch roller, etc., or poor tape.</li> <li>● Tape is wound unevenly.</li> </ul>	<ul style="list-style-type: none"> <li>● Clean capstan and pinch roller, or change to better tape.</li> <li>● Rewind tape.</li> </ul>
<b>Tape stops in the middle of recording or playback.</b>	<ul style="list-style-type: none"> <li>● Slack tape, or tape spillage wound around capstan.</li> </ul>	<ul style="list-style-type: none"> <li>● Insert pencil in hole in cassette shell and turn to take up slack.</li> </ul>
<b>Fails to record.</b>	<ul style="list-style-type: none"> <li>● REC LEVEL control is set to too low.</li> <li>● Protective tabs are broken off.</li> </ul>	<ul style="list-style-type: none"> <li>● Adjust REC LEVEL control.</li> <li>● Change tape or cover protective hole with adhesive tape.</li> </ul>
<b>Search does not operate correctly.</b>	<ul style="list-style-type: none"> <li>● Blank section is too short.</li> <li>● Recorded section has low-level portions.</li> <li>● Conversation, etc. has been recorded.</li> </ul>	<ul style="list-style-type: none"> <li>● Blank sections must be at least 4 seconds long.</li> <li>● No remedy</li> <li>● No remedy</li> </ul>
<b>High frequencies in the playback sound are emphasized and unpleasant to listen to, and noise level (hiss) is also high.</b>	<ul style="list-style-type: none"> <li>● Dolby NR-recorded tape is played back in OFF position.</li> </ul>	<ul style="list-style-type: none"> <li>● Play back in appropriate Dolby NR position.</li> </ul>
<b>Playback sound is muffled and high frequencies are inaudible.</b>	<ul style="list-style-type: none"> <li>● Normally-recorded tape is played back in Dolby NR.</li> <li>● Heads are dirty.</li> <li>● Heads are magnetized.</li> </ul>	<ul style="list-style-type: none"> <li>● Play back in OFF position.</li> <li>● Clean heads and carry out demagnetization with head demagnetizer.</li> </ul>
<b>When playing back tapes recorded on other decks, meter deflections are greater (smaller) than when recorded.</b>	<ul style="list-style-type: none"> <li>● Basic levels are different for different cassette decks.</li> </ul>	<ul style="list-style-type: none"> <li>● This is not a fault.</li> </ul>
<b>The remote control transmitter cannot be operated.</b>	<ul style="list-style-type: none"> <li>● The batteries are exhausted.</li> <li>● The remote control transmitter is operated from an incorrect distance or angle.</li> <li>● The remote control sensor is lighted strongly.</li> </ul>	<ul style="list-style-type: none"> <li>● Replace batteries.</li> <li>● Operate it from less than 7 meters (about 23 ft.) and 30°.</li> <li>● Place the unit away from the strong light.</li> </ul>

# SPECIFICATIONS

**Type** ..... Auto reverse 4-track, 2-channel recording and playback stereo double cassette deck

**Motors** ..... DC servo motor x 2 (main)

**Heads**

KX-W592 ..... Recording/playback: Hard Permalloy x 2  
Erase: Double-gap Ferrite x 2

KX-W492/KX-W392  
..... Recording/playback: Hard Permalloy x 1  
Erase: Double-gap Ferrite x 1  
Playback: Hard Permalloy x 1

**Rapid Transport** ..... 100 sec. (C-60)

**Wow and Flutter**

**WRMS** ..... 0.08%

**W.Peak** ..... ±0.15%

**Signal-to-Noise Ratio**

(Dolby NR off) ..... 58 dB

(Dolby B NR on) ..... 66 dB

(Dolby C NR on) ..... 74 dB

**Frequency Response (-20 dB)**

<KX-W592/KX-W492>

**Type I/Normal** ..... 20 ~ 17,000 Hz ±3 dB

**Type II/High (CrO<sub>2</sub>)** ..... 20 ~ 18,000 Hz ±3 dB

**Type IV/Metal** ..... 20 ~ 20,000 Hz ±3 dB

<KX-W392>

**Type I/Normal** ..... 20 ~ 16,000 Hz ±3 dB

**Type II/High (CrO<sub>2</sub>)** ..... 20 ~ 17,000 Hz ±3 dB

**Type IV/Metal** ..... 20 ~ 19,000 Hz ±3 dB

**Harmonic Distortion**

KX-W592/KX-W492 ..... less than 0.8%

KX-W392 ..... less than 1.0%

**Input Sensitivity/Impedance**

**Line** ..... 100 mV/40 k-ohms (KX-W592)  
100 mV/43 k-ohms (KX-W492/KX-W392)

**Output Level**

**Line** ..... 570 mV/1.8 k-ohms (KX-W592)  
570 mV/1.4 k-ohms (KX-W492/KX-W392)

**Phones** ..... 0.08 mV/8 ohms (KX-W592)  
0.25 mV/8 ohms (KX-W492/KX-W392)

**Channel Separation (1 kHz)** ..... more than 40 dB

**Crosstalk (125 Hz)** ..... more than 55 dB

## GENERAL

### Power Supply

**U.S.A. and Canada model** ..... 120 V, 60 Hz

**Europe model and U.K. model** ..... 230 V, 50 Hz

**Australia model** ..... 240 V, 50 Hz

**General model** ..... 110/120/220/240 V, 50/60 Hz

### Power Consumption

KX-W592 ..... 19 W/9 W (POWER OFF)

KX-W492 ..... 14 W/7 W (POWER OFF)

KX-W392

**U.S.A. and Canada model** .... 11 W/7 W (POWER OFF)

**Other models** ..... 12 W/7 W (POWER OFF)

**Dimensions (W x H x D)** ..... 435 x 146 x 283 mm  
(17-1/8" x 5-3/4" x 11-1/8")

**Weight** ..... 5.1 kg (11 lbs. 4 oz.) (KX-W592)  
5.0 kg (11 lbs.) (KX-W492/KX-W392)

### Accessory

**Audio cord** ..... 1 pair

\* Specifications subject to change without notice.

# YAMAHA

---

**YAMAHA ELECTRONICS CORPORATION, USA** 6660 ORANGETHORPE AVE., BUENA PARK, CALIF. 90620, U.S.A.  
**YAMAHA CANADA MUSIC LTD.** 135 MILNER AVE., SCARBOROUGH, ONTARIO M1S 3R1, CANADA  
**YAMAHA ELECTRONIK EUROPA G.m.b.H.** SIEMENSSTR. 22-34, 25462 RELINGEN, BEI HAMBURG, F.R. OF GERMANY  
**YAMAHA ELECTRONIQUE FRANCE S.A.** RUE AMBROISE CROIZAT BP70 CROISSY-BEAUBOURG 77312 MARNE-LA-VALLEE CEDEX02, FRANCE  
**YAMAHA ELECTRONICS (UK) LTD.** YAMAHA HOUSE, 200 RICKMANSWORTH ROAD WATFORD, HERTS WD1 7JS, ENGLAND  
**YAMAHA SCANDINAVIA A.B.** J A WETTERGRENS GATA 1, BOX 30053, 400 43 VASTRA FRÖLUNDA, SWEDEN  
**YAMAHA MUSIC AUSTRALIA PTY, LTD.** 17-33 MARKET ST., SOUTH MELBOURNE, 3205 VIC., AUSTRALIA

YAMAHA CORPORATION

VU 20810

## Free Manuals Download Website

<http://myh66.com>

<http://usermanuals.us>

<http://www.somanuals.com>

<http://www.4manuals.cc>

<http://www.manual-lib.com>

<http://www.404manual.com>

<http://www.luxmanual.com>

<http://aubethermostatmanual.com>

Golf course search by state

<http://golfingnear.com>

Email search by domain

<http://emailbydomain.com>

Auto manuals search

<http://auto.somanuals.com>

TV manuals search

<http://tv.somanuals.com>