

DVD PLAYER  
LECTEUR DE DVD

# DVD-S550

*OWNER'S MANUAL  
MODE D'EMPLOI  
BEDIENUNGSANLEITUNG  
BRUKSANVISNING  
GEBRUIKSAANWIJZING  
ИНСТРУКЦИЯ ПО ЭКСПЛУАТАЦИИ*

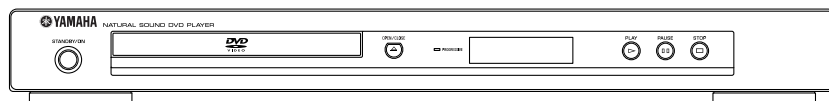

## Important notes for users in the U.K.

### Mains plug

This apparatus is fitted with an approved 13 Amp plug. To change a fuse in this type of plug proceed as follows:

- 1 Remove fuse cover and fuse.
- 2 Fix new fuse which should be a BS1362 5 Amp, A.S.T.A. or BSI approved type.
- 3 Refit the fuse cover.

If the fitted plug is not suitable for your jack outlets, it should be cut off and an appropriate plug fitted in its place.

If the mains plug contains a fuse, this should have a value of 5 Amp. If a plug without a fuse is used, the fuse at the distribution board should not be greater than 5 Amp.

*Note: The severed plug must be disposed to avoid a possible shock hazard should it be inserted into a 13 Amp jack elsewhere.*

### How to connect a plug

The wires in the mains lead are coloured with the following code: blue = neutral (N), brown = live (L).

- As these colours may not correspond with the colour markings identifying the terminals in your plug, proceed as follows:
  - Connect the blue wire to the terminal marked N or coloured black.
  - Connect the brown wire to the terminal marked L or coloured red.
  - Do not connect either wire to the earth terminal in the plug, marked E (or e) or coloured green (or green and yellow).

Before replacing the plug cover, make certain that the cord grip is clamped over the sheath of the lead - not simply over the two wires.

### Copyright in the U.K.

Recording and playback of material may require consent. See Copyright Act 1956 and The Performer's Protection Acts 1958 to 1972.

## VAROITUS

Muiden kuin tässä esitettyjen toimintojen säädön tai asetusten muutto saattaa altistaa vaaralliselle säteilylle tai muille vaarallisille toiminnoille.

### DK

Advarsel: Usynlig laserstråling ved åbning når sikkerhedsafbrydere er ude af funktion. Undgå udsættelse for stråling.

Bemærk: Netafbryderen STANDBY/ON er sekundært indkoblet og afbryder ikke strømmen fra nettet. Den indbyggede netdel er derfor tilsluttet til lysnettet så længe netstikket sidder i stikkontakten.

### N

Observer: Nettbryteren STANDBY/ON er sekundert innkoplek. Den innebygdenetdelen er derfor ikke frakoplek nettet så lenge apparatet er tilsluttet nettkontakten.

### S

Klass 1 laseraparat

Varning! Om apparaten används på annat sätt än i denna bruksanvisning specificerats, kan användaren utsättas för osynlig laserstrålning, som överskrider gränsen för laserklass 1.

Observera! Strömbrytaren STANDBY/ON är sekundärt kopplad och inte bryter inte strömmen från nätet. Den inbyggda nät delen är därför ansluten till elnätet så länge stickproppen sitter i vägguttaget.

### SF

Luokan 1 laserlaite

Varoitus! Laitteen käyttäminen muulla kuin tässä käyttöohjeessa mainitulla tavalla saattaa altistaa käyttäjän turvallisuusluokan 1 ylittävälle näkymättömälle lasersäteilylle.

Oikeus muutoksiin varataan. Laitte ei saa olla alltiina tippu-ja roiskevedelle.

Toiminnanvalitsin STANDBY/ON on kytketty toisiopuolelle, eikä se kytke laitetta irti sähköverkosta. Sisäänrakennettu verkko-osa on kytkettynä sähköverkkoon aina silloin, kun pistoke on pistorasiassa.

### VARO!

**AVATTAESSA JA SUOJALUKITUS OHITETTAESSA OLET ALTTIINA NÄKYMÄTTÖMÄLLE LASERSÄTEILYLLE. ÄLÄ KATSO SÄ TEESEEN.**

### VARNING!

**OSYNLIG LASERSTRÅLNING NÄR DENNA DEL ÄR ÖPPNAD OCH SPÄREN ÄR URKOPPLAD. BETRakta EJ STRÅLEN.**

<p><b>CAUTION</b> Use of controls or adjustments or performance of procedures other than those specified herein may result in hazardous radiation exposure.</p>
<p><b>ATTENTION</b> L'emploi de commandes, de réglages ou un choix de procédures différents des spécifications de cette brochure peut entraîner une exposition à d'éventuelles radiations pouvant être dangereuses.</p>
<p><b>ACHTUNG</b> Die Verwendung von Bedienungselementen oder Einstellungen oder die Durchführung von Bedienungsvorgängen, die nicht in dieser Anleitung aufgeführt sind, kann zu einem Kontakt mit gefährlichen Laserstrahlen führen.</p>
<p><b>OBSERVERA</b> Användning av kontroller och justeringar eller genomförande av procedurer andra än de som specificeras i denna bok kan resultera i att du utsätter dig för farlig strålning.</p>
<p><b>VOORZICHTIG</b> Gebruik van bedieningsorganen of instellingen, of uitvoeren van handelingen anders dan staan beschreven in deze handleiding kunnen leiden tot blootstelling aan gevaarlijke stralen.</p>
<p><b>ПРЕДУПРЕЖДЕНИЕ</b> Использование органов управления или настроек или выполнение процедур, отличных от описанных в данном руководстве, могут привести к опасному облучению.</p>

<p>The unit is not disconnected from the AC power source as long as it is connected to the wall outlet, even if this unit itself is turned off. This state is called the standby mode. In this state, this unit is designed to consume a very small quantity of power.</p>
<p>L'appareil n'est pas isolé de la source d'alimentation aussi longtemps qu'il reste branché sur une prise murale, même lorsqu'il est éteint. Il est alors dit en mode «Veille». Dans ce mode, l'appareil consomme très peu de courant.</p>
<p>Das Gerät ist nicht vom Netz getrennt, solange der Netzstecker noch mit der Wandsteckdose verbunden ist, selbst wenn das Gerät ausgeschaltet wurde. Dieser Betriebszustand wird als Bereitschaftsmodus bezeichnet. In diesem Zustand nimmt das Gerät eine sehr geringe Menge Strom auf.</p>
<p>Enheten är inte urkopplad från nätet så länge som den är ansluten till vägguttaget även om enheten i sig självt är avstängd. Detta kallas för beredskapsläge och i detta tillstånd konsumerar apparaten minimalt med ström.</p>
<p>De stroomtoevoer naar het toestel is niet afgesloten zolang de stekker nog in het stopcontact zit, zelfs niet als het toestel zelf uitgeschakeld is. Deze toestand wordt "standby" (waak- of paraatstand) genoemd. Het toestel is ontworpen om in deze toestand.</p>
<p>Данное устройство не отсоединено от источника переменного напряжения до тех пор, пока оно подключено к настенной розетке, даже если само данное устройство выключено. Это состояние называется режимом готовности. В этом состоянии данное устройство потребляет очень малое количество электроэнергии.</p>

<p><b>CAUTION</b> VISIBLE AND INVISIBLE LASER RADIATION WHEN OPEN. AVOID EXPOSURE TO BEAM.</p> <p><b>ADVARSEL</b> SYNLIG OG USYNLIG LASERSTRÅLING VED ÅBNING. UNDGÅ UDSÆTTELSE FOR STRÅLING.</p> <p><b>ADVARSEL</b> SYNLIG OG USYNLIG LASERSTRÅLING NÅR DEKSEL ÅPNES. UNNGÅ EKSPONERING FOR STRÅLEN.</p> <p><b>WARNING</b> SYNLIG OCH OSYNLIG LASERSTRÅLNING NÄR DENNA DEL ÄR ÖPPNAD. BETRAKTA EJ STRÅLEN.</p> <p><b>VARO!</b> AVATTAESSA OLET ALTTIINA NÄKYVÄLLE JA NÄKYMÄTTÖMÄLLE LASER SÄ TEILYLLE. ÄLÄ KATSO SÄTEESEEN.</p> <p><b>VORSICHT</b> SICHTBARE UND UNSICHTBARE LASERSTRAHLUNG WENN ABDECKUNG GEÖFFNET. NICHT DEM STRAHL AUSSETZEN.</p> <p><b>DANGER</b> VISIBLE AND INVISIBLE LASER RADIATION WHEN OPEN. AVOID DIRECT EXPOSURE TO BEAM.</p> <p><b>ATTENTION</b> RAYONNEMENT LASER VISIBLE ET INVISIBLE EN CAS D'OUVERTURE. EXPOSITION DANGEREUSE AU FAISCEAU.</p> <p><b>ПРЕДУПРЕЖДЕНИЕ</b> ПРИ ОТКРЫТИИ УСТРОЙСТВА ВЫ МОЖЕТЕ ПОДВЕРГНУТЬСЯ ВОЗДЕЙСТВИЮ ВИДИМОГО И НЕВИДИМОГО ЛАЗЕРНОГО ИЗЛУЧЕНИЯ. ИЗБЕГАЙТЕ ВОЗДЕЙСТВИЯ ЛУЧА.</p>
-------------------------------------------------------------------------------------------------------------------------------------------------------------------------------------------------------------------------------------------------------------------------------------------------------------------------------------------------------------------------------------------------------------------------------------------------------------------------------------------------------------------------------------------------------------------------------------------------------------------------------------------------------------------------------------------------------------------------------------------------------------------------------------------------------------------------------------------------------------------------------------------------------------------------------------------------------------------------------------------------------------------------------------------------------------------------------------

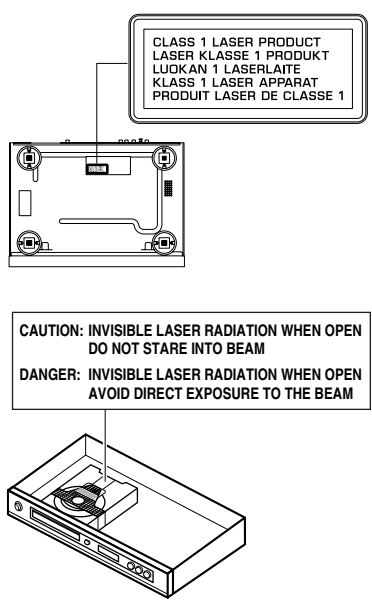

# CAUTION: READ THIS BEFORE OPERATING YOUR UNIT.

- 1 To assure the finest performance, please read this manual carefully. Keep it in a safe place for future reference.
- 2 Install this sound system in a well ventilated, cool, dry, clean place — away from direct sunlight, heat sources, vibration, dust, moisture, or cold. In a cabinet, allow about 2.5cm (1 inch) of free space all around this unit for adequate ventilation.
- 3 Locate this unit away from other electrical appliances, motors, or transformers to avoid humming sounds.
- 4 Do not expose this unit to sudden temperature changes from cold to hot, nor locate this unit in an environment with high humidity (i.e., a room with a humidifier) to prevent condensation inside this unit, which may cause an electrical shock, fire, damage to this unit, and/or personal injury.
- 5 Avoid installing this unit in a location where foreign objects may fall onto this unit or where this unit may be exposed to liquid dripping or splashing. On the top of this unit, do not place:
  - Other components, as they may cause damage and/or discoloration on the surface of this unit.
  - Burning objects (i.e., candles), as they may cause fire, damage to this unit, and/or personal injury.
  - Containers with liquid in them, as they may fall, spilling the liquid and causing an electrical shock to the user and/or damage to this unit.
- 6 Do not cover this unit with a newspaper, tablecloth, curtain, etc. in order not to obstruct heat radiation. If the temperature inside this unit rises, it may cause fire, damage to this unit, and/or personal injury.
- 7 Do not plug in this unit to a wall outlet until all connections are complete.
- 8 Do not operate this unit upside-down. It may overheat, possibly causing damage.
- 9 Do not use excessive force on switches, knobs and/or cords.
- 10 When disconnecting the power cord from the wall outlet, grasp the plug; do not pull the cord.
- 11 Do not clean this unit with chemical solvents; this might damage the finish. Use a clean, dry cloth.
- 12 Use only the voltage specified on this unit. Using this unit with a higher voltage than specified is dangerous and may cause fire, damage to this unit, and/or personal injury. YAMAHA will not be held responsible for any damage resulting from use of this unit with a voltage other than as specified.
- 13 To prevent damage by lightning, disconnect the power cord from the wall outlet during an electrical storm.
- 14 Do not attempt to modify or fix this unit. Contact qualified YAMAHA service personnel when any service is needed. The cabinet should never be opened for any reason.
- 15 When not planning to use this unit for long periods of time (i.e., vacation), disconnect the AC power plug from the wall outlet.
- 16 Be sure to read the "TROUBLESHOOTING" section on common operating errors before concluding that this unit is faulty.
- 17 Before moving this unit, press STANDBY/ON to set the unit in standby mode, then disconnect the AC power plug from the wall outlet.

## WARNING

TO REDUCE THE RISK OF FIRE OR ELECTRIC SHOCK, DO NOT EXPOSE THIS UNIT TO RAIN OR MOISTURE.

When playing DTS encoded CDs, excessive noise will be heard from the analog stereo outputs. To avoid possible damage to the audio system, the consumer should take proper precautions when the analog stereo outputs of the player are connected to an amplification system. To enjoy DTS Digital Surround™ playback, an external 5.1-channel DTS Digital Surround™ decoder system must be connected to the digital output of the player.

## LASER SAFETY

This unit employs a laser. Due to possible eye injury, only a qualified service person should remove the cover or attempt to service this device.

## DANGER

This unit emits visible laser radiation when open. Avoid direct eye exposure to beam. When this unit is plugged into a wall outlet, do not place your eyes close to the opening of the disc tray and other openings or look inside.

## Introduction

Region Codes.....	2
Supplied accessories.....	2
Notes about discs.....	2
Cleaning discs.....	2
Patent information.....	2

## Functional Overview

Front and Rear Panels.....	3
Remote Control.....	4

## Preparation

General Notes on connections.....	5
Digital Connections.....	5
Analog Connections.....	5
Video Connections.....	6
S-Video terminal <A>.....	6
Composite Video terminal <B>.....	6
Component Video terminal <C>.....	6
SCART Connection <D>.....	6

## Getting Started

Inserting batteries into the Remote Control.....	7
Using the remote control.....	7
Turning on the power.....	7
Selecting the color system that corresponds to your TV.....	7
Setting language preference.....	8
Setting the OSD Language.....	8
Setting the Audio, Subtitle and Disc menu language.....	9

## Disc Operations

Basic Playback.....	10
General Operation.....	10
Pausing playback.....	10
Selecting track/chapter.....	10
Searching backward/forward.....	10
Stopping playback.....	10
Selecting various repeat/shuffle functions.....	11
Repeat and Shuffle.....	11
Repeating a section within a chapter/track.....	11
Operations for video playback (DVD/VCD/SVCD) ..	11
Using the Disc Menu.....	11
Zooming in.....	11
Resuming playback from the last stopped point.....	11
On-Screen Display (OSD).....	12
Special DVD Features.....	13
Playing a Title.....	13
Camera Angle.....	13
Audio.....	13
Subtitles.....	13

Special VCD & SVCD Features.....	13
Playback Control (PBC).....	13
Preview Function.....	13
Playing MP3/DivX/JPEG/Kodak Picture CD.....	14
General Operation.....	14
Selecting a folder and track/file.....	15
Repeat and Shuffle.....	15
Special picture disc features.....	15
Preview Function (JPEG).....	15
Zoom picture.....	16
Playback with multi-angles.....	16
Scan Effect.....	16
Playing MP3 music and JPEG picture simultaneously.....	16

## Setup Menu

General Setup menu.....	17
Locking/Unlocking the disc for viewing.....	17
Dimming player's front panel display.....	17
Programming disc tracks (not for Picture CD/MP3).....	17
OSD Language.....	18
Screen Saver.....	18
Sleep Timer.....	18
DivX® VOD registration code.....	19
Audio Setup Menu.....	19
Setting the analog output.....	19
Setting the Digital output.....	20
CD Upsampling.....	20
Night Mode.....	21
Video Setup Menu.....	21
TV Type.....	21
Setting the TV Display.....	21
Progressive.....	22
Picture Setting.....	22
Switching the YUV/RGB.....	23
Preference Setup Menu.....	24
Audio, Subtitle, Disc Menu.....	24
Restricting playback by Parental Control.....	24
PBC (Playback Control).....	24
MP3/JPEG Menu.....	25
Changing the Password.....	25
Restoring to original settings.....	25

## Language Code..... 26

## Troubleshooting..... 28

## Glossary..... 30

## Specifications..... 31

# Introduction

Thank you for purchasing this unit. This Owner's Manual explains the basic operation of this unit.

## Region Codes

DVD discs must be labeled for ALL regions or Region 2 in order to play on this Player. You cannot play Discs that are labeled for other regions.



## Supplied accessories

- Remote control
- Batteries (two AA size) for remote control
- Audio pin cable
- Video pin cable
- Owner's Manual

## Notes about discs

- *This unit is designed for use with DVD video, Video CD, Super video CD, Audio CD, CD-R, CD-RW, DVD+RW, DVD+R, DVD-R and DVD-RW.*

*This unit can play:*

- MP3, picture (Kodak, JPEG) files on CD-R(W).
- JPEG/ISO 9660 format
- Maximum 30 characters display.
- DivX<sup>®</sup> disc on CD-R[W]/DVD+R[W]/DVD-R[W] (3.11, 4.x and 5.x)
- CD-R and CD-RW cannot be played unless finalized.
- Some discs cannot be played depending on the recording conditions such as PC environment and application software. The characteristics and condition of the discs; materials, scratches, curvature, and etc., may result in failure.
- Be sure to use only CD-R and CD-RW discs made by reliable manufacturers.
- Do not use any non standard shaped discs (heart, etc.)
- Do not use disc with tape, scals, or paste on it, damage to the unit may result.

- *Do not use a disc printed on its surface by a commercially available label printer.*

## Cleaning discs

- When a disc becomes dirty, clean it with a cleaning cloth. Wipe the disc from the centre out. Do not wipe in a circular motion.
- Do not use solvents such as benzene, thinner, commercially available cleaners, or antistatic spray intended for analog records.

## Patent information



Manufactured under license from Dolby Laboratories. "Dolby" and the double-D symbol are trademarks of Dolby Laboratories.



"DTS" and "DTS Digital Out" are trademarks of Digital Theater Systems, Inc.



DivX, DivX Certified, and associated logos are trademarks of DivXNetworks, Inc and are used under license.

This product incorporates copyright protection technology that is protected by method claims of certain U.S. patents and other intellectual property rights owned by Macrovision Corporation and other rights owners. Use of this copyright protection technology must be authorized by Macrovision Corporation, and is intended for home and other limited viewing uses only unless otherwise authorized by Macrovision Corporation. Reverse engineering or disassembly is prohibited.

## Front and Rear Panels

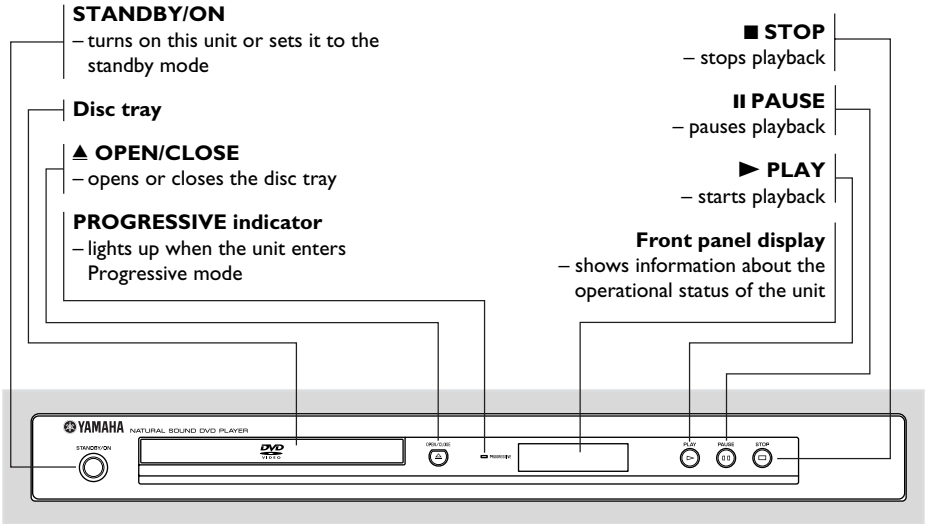

\* Press button for about two seconds.

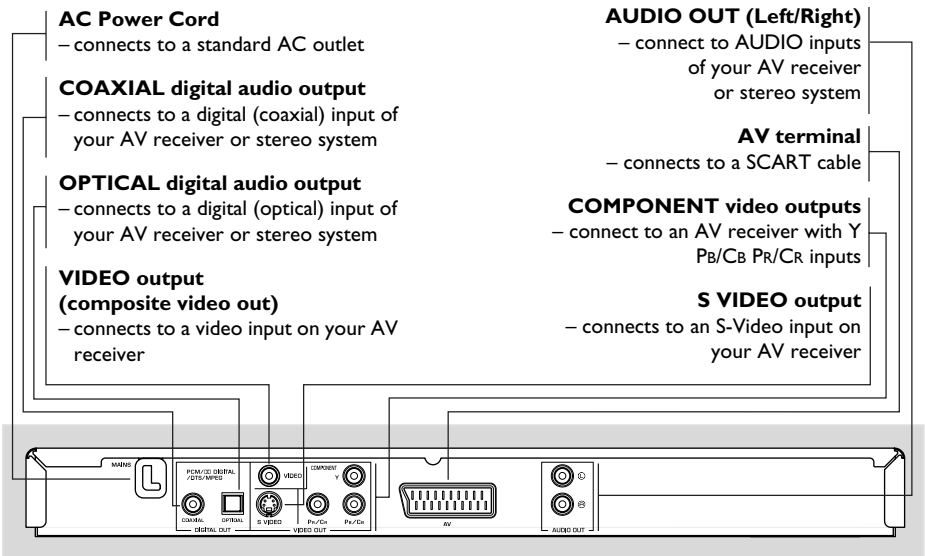

**Caution: Do not touch the inner pins of the jacks on the rear panel. Electrostatic discharge may cause permanent damage to the unit.**

# Functional Overview

## Remote Control

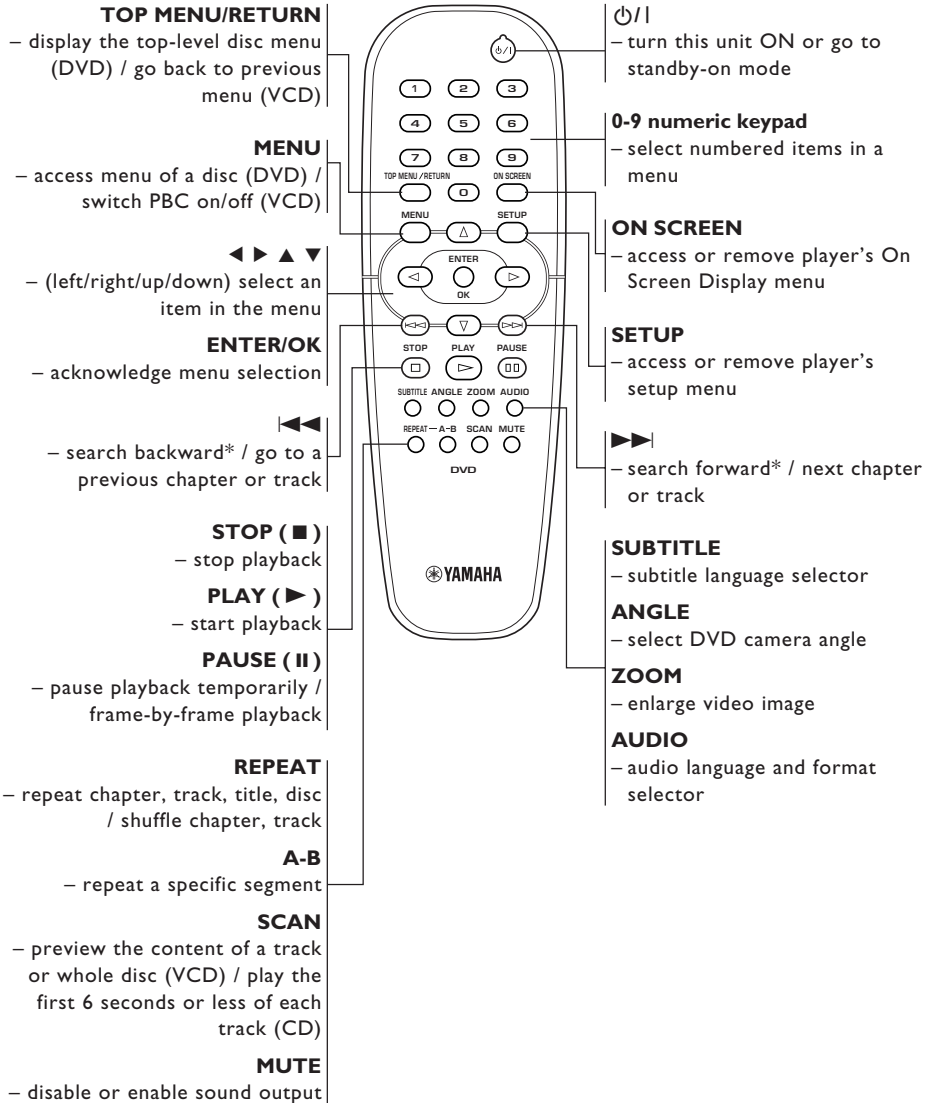

\* Press and hold button for about two seconds.



## General Notes on connections

Never make or change connections with the power switched on.

- Depending on the equipment you wish to connect, there are various ways you could connect this unit. Possible connections are shown in the following drawings.
- Please refer to the manuals of other equipment as necessary to make the best connections.
- Do not connect this unit via your VCR. The video quality could be distorted by the copy protection system.
- Do not connect this unit's audio out jack to the phono in jack of your audio system.

## Digital Connections

This unit has COAXIAL and OPTICAL digital out jacks. Connect one or both of them to your AV receiver equipped with Dolby digital, DTS, or MPEG decoder using each specific cable (separate purchase).

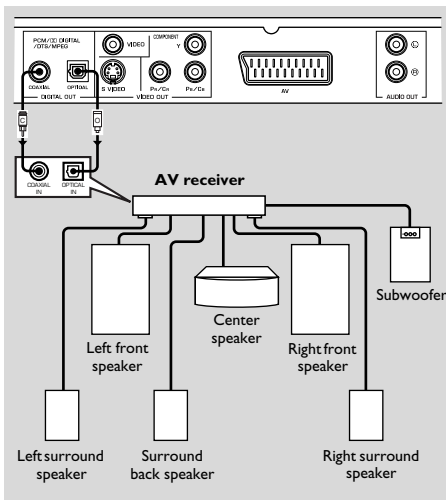

**You will need to set this unit's digital output to ALL (see page 20 "DIGITAL OUTPUT").**

Note:

- If the audio format of the digital output does not match the capabilities of your receiver, the receiver will produce a strong, distorted sound or no sound at all. Make sure to select the appropriate audio format at menu screen included on the disc. Pressing **AUDIO** once or more may change not only audio languages but also audio formats, and the selected format appears for several seconds on the status window.

## Analog Connections

Use audio/video cable supplied with this unit to connect AUDIO OUT L (left) and R (right) jacks of this unit to corresponding input jacks of your audio equipment such as Stereo amplifier.

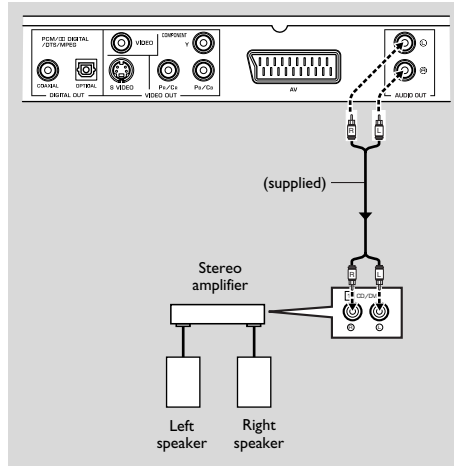

# Preparation

## Video Connections

If your AV receiver has video output jacks, connect your receiver (and then to your TV) so that you can use one TV for several different video sources (LD, VCR etc.) by simply switching the input source selector of your receiver.

The player has three types of video output jacks. Use one of them in accordance with the input jacks of the equipment to be connected.

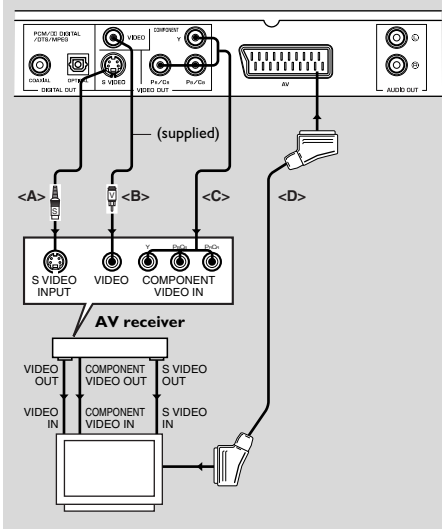

## S-Video terminal <A>

S (separate) video connection achieves a clearer picture than composite video connection by separating color and luminance when transmitting signals. Use commercially available S-video cable. Receiver (and TV) with S-video input is required.

## Composite Video terminal <B>

Use audio/video cable supplied with this unit when connecting the player to a TV.

## Component Video terminal <C>

Component video connection achieves high fidelity in reproducing colors (better performance than S-video connection), separating video signal into luminance (Y, terminal color-coded as green), and color difference (Pb, blue/Pr, red). Use commercially available coaxial cables. Receiver (and TV) with component input is required. Observe the color of each jack when connecting. If your receiver does not have component output jacks, connecting the player's component output directly to your TV's component input can reproduce better video image.

Note:

- You need to set this unit's component output to YUV (see page 23 "Switching the YUV/RGB").

## SCART Connection <D>

If your TV has only terminal for video input, and you want to connect it directly to this unit, you can use this unit's SCART output jack.

Note:

- Ensure that the "TV" indication on SCART cable is connected to the TV set and "DVD" indication on SCART cable is connected to this unit.

## Step1: Inserting batteries into the Remote Control

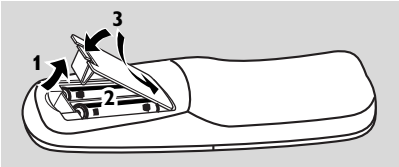

- 1 Open the battery compartment.
- 2 Insert two batteries type R06 or AA, following the indications (+ -) inside the compartment.
- 3 Close the cover.

## Using the remote control

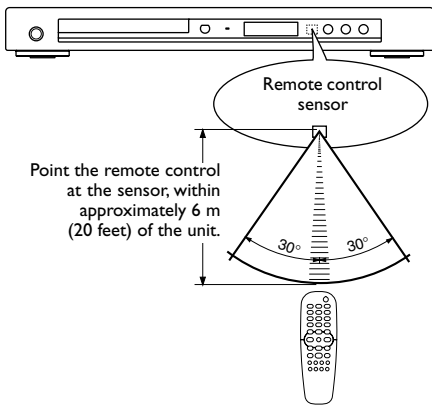

## Handling the remote control

- Do not spill water or other liquids on the remote control.
- Do not drop the remote control.
- Do not leave or store the remote control in the following types of conditions:
  - high humidity such as near a bath
  - high temperature such as near a heater or stove
  - extremely low temperature
  - dusty places

## Step2: Turning on the power

- 1 Connect the AC power cord to the power outlet.
- 2 Turn on the TV and your AV receiver.
- 3 Select the appropriate input source at the AV receiver that was used to connect to this unit. Refer to the equipment owner's manual for detail.
- 4 Turn this unit on.
- 5 Set the TV to the correct Video IN channel. (eg. EXT1, EXT2, AV1, AV2, AUDIO/VIDEO, etc. Refer to your TV owner's manual for detail)
  - ➔ The front display lights up and the default screen appears on the TV.

## Step3: Selecting the color system that corresponds to your TV

This DVD Player is compatible with both NTSC and PAL. Select the color system that matches your TV.

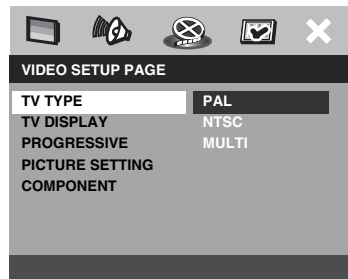

- 1 Press **SETUP**.
- 2 Press **▶** repeatedly to select {VIDEO SETUP PAGE}.
- 3 Press **▲▼** to highlight {TV TYPE}, then press **▶**.



## Setting the Audio, Subtitle and Disc menu language



- 1 Press **STOP** ■ twice, then press **SETUP**.
- 2 Press ► repeatedly to select {PREFERENCE PAGE}.
- 3 Press ▲▼ to highlight one of the options below at a time, then press ►.
  - ‘Audio’ (disc’s soundtrack)
  - ‘Subtitle’ (disc’s subtitles)
  - ‘Disc Menu’ (disc’s menu)
- 4 Press ▲▼ to select a language and press **ENTER/OK**.

**If the language you want is not in the list, then select {OTHERS},** then use the **numeric keypad (0-9)** on the remote to enter the 4-digit language code (see page 26 “Language Code”) and press **ENTER/OK**.

- 5 Repeat steps 3–4 for other language settings.

**TIPS:** To return to the previous menu, press ◀.  
To remove the menu, press **SETUP**.

# Disc Operations

## IMPORTANT!

- If the inhibit icon (⊘ or X) appears on the TV screen when a button is pressed, it means the function is not available on the current disc or at the current time.
- Depending on the DVD or VIDEO CD, some operations may be different or restricted.
- Do not push on the disc tray or put any objects other than disc on the disc tray. Doing so may cause the disc player malfunction.

## Basic Playback

- 1 Press **STANDBY/ON** on the front panel to turn on the DVD player.
- 2 Press **OPEN/CLOSE ▲** on the front panel to open disc loading tray.
- 3 Place the chosen disc in the tray, with the label facing up.
- 4 Press **OPEN/CLOSE ▲** again to close the tray.
  - After recognizing this disc, the player begin to playback automatically.
  - If you press **PLAY ►** when the tray is open, this unit closes the tray and starts playback.

## General Operation

Unless otherwise stated, all operations described are based on Remote Control use.

## Pausing playback

- 1 During playback, press **PAUSE II**.
  - Playback will pause and sound will be muted.
- 2 Press **PAUSE II** again to select the next picture frame.
- 3 To resume normal playback, press **PLAY ►**.

## Selecting track/chapter

- Press |◀◀ / ▶▶| or use the **numeric keypad (0-9)** to key in a track/chapter number.
- If repeat mode is active, pressing |◀◀ / ▶▶| will replay the same track/chapter.

## Searching backward/forward

- Press and hold |◀◀ / ▶▶|, then press **PLAY ►** to resume normal playback.
- While searching, pressing |◀◀ / ▶▶| again will decrease/increase the search speed.

## Stopping playback

- Press **STOP ■**.

**TIPS:** The operating features described here might not be possible for certain discs. Always refer to the instructions supplied with the discs.

## Selecting various repeat/shuffle functions

### Repeat and Shuffle

- While playing a disc, press **REPEAT** continuously to choose a 'Play Mode'.

#### DVD

- RPT ONE (repeat chapter)
- RPT TT (repeat title)
- SHUFFLE (shuffle)
- RPT SHF (shuffle repeat)
- RPT OFF (repeat off)

#### VCD/SVCD/CD

- RPT ONE (repeat track)
- RPT ALL (repeat disc)
- SHUFFLE (shuffle)
- RPT SHF (shuffle repeat)
- RPT OFF (repeat off)

#### MP3/DivX

- RPT ONE (repeat track)
- RPT FLD (repeat folder)
- SHUFFLE (random play)
- RPT OFF (repeat off)

#### *Helpful Hint:*

- For VCD, repeat playback is not possible if the PBC mode is switched on.

### Repeating a section within a chapter/track

- 1 While playing a disc, press **A-B** at your chosen starting point.
- 2 Press **A-B** again at your chosen end point.
  - The section A and B can be set only within the same chapter/track.
  - The section will now repeat continuously.
- 3 To exit the sequence, press **A-B**.

## Operations for video playback (DVD/VCD/SVCD)

### Using the Disc Menu

Depending on the disc, a menu may appear on the TV screen once you load in the disc.

#### To select a playback feature or item

- Use ◀▶▲▼ or numeric keypad (0-9) on the remote, then press **ENTER/OK** to start playback.

#### To access or remove the menu

- Press **MENU** on the remote.

### Zooming in

This function allows you to enlarge the picture on the TV screen and to pan through the enlarged picture.

- 1 During playback, press **ZOOM** repeatedly to display the picture with different scales.
  - Use ◀▶▲▼ to pan through the enlarged picture.
  - Playback will continue.
- 2 Press **ZOOM** repeatedly to return to the original size.

### Resuming playback from the last stopped point

Resume playback of the last 10 discs is possible, even if the disc was ejected or the power switched off.

- Load one of the last 10 discs.
- "LOADING" appears.
- Press **PLAY ▶** and the disc will be played back from the last point.

#### To cancel resume mode

- In stop mode, press **STOP ■** again.

**TIPS:** The operating features described here might not be possible for certain discs. Always refer to the instructions supplied with the discs.

# Disc Operations

## On-Screen Display (OSD)

OSD menu shows the disc playback information (for example, title or chapter number, elapsed playing time, audio/subtitle language), a number of operations can be done without interrupting disc playback.

- 1 During playback, press **ON SCREEN**.  
→ A list of available disc information appears on the TV screen.

## DVD



MENU	
TITLE	02/14
CHAPTER	02/14
AUDIO	5.1CH
SUBTITLE	ENG
BITRATE ██████████	

## VCD/SVCD

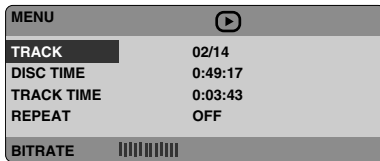

MENU	
TRACK	02/14
DISC TIME	0:49:17
TRACK TIME	0:03:43
REPEAT	OFF
BITRATE ██████████	

- 2 Press **▲▼** to view the information and press **ENTER/OK** to access.
- 3 Use the **numeric keypad (0-9)** to input the number/time or press **▲▼** to make the selection, then press **ENTER/OK** to confirm.  
→ Playback will change to the chosen time or to the selected title/chapter/track.

## Title/Chapter/Track selection (DVD/VCD)

- 1 Press **▲▼** to select {TITLE} or {CHAPTER} (DVD) or {TRACK} (VCD).
- 2 Press **ENTER/OK**.
- 3 Select a title, chapter or track number using the numeric buttons.

## Time Search (DVD/VCD)

- 1 Press **▲▼** to select {TT TIME} or {CH TIME} (DVD) or {TRACK TIME} or {DISC TIME} (VCD).  
→ {TT TIME} refers to the total time of the current title, and the {CH TIME} refers to the total time of the current chapter.
- 2 Press **ENTER/OK**.
- 3 Enter hours, minutes and seconds from left to right using the numeric buttons. (e.g. 0:34:27)

## Audio/Subtitle/Angle (DVD)

You can change {AUDIO}, {SUBTITLE} or {ANGLE} if available on the disc you are playing.

- 1 Press **▲▼** to select {AUDIO}, {SUBTITLE} or {ANGLE}.
- 2 Press **ENTER/OK**.
- 3 For Audio and Subtitle, Press **▲▼** to highlight your selection and press **ENTER/OK**.

For Angle,  
Select an angle using the numeric buttons.

## Repeat/Time Display (DVD/VCD)

- 1 Press **▲▼** to select {REPEAT} or {TIME DISP.}.
- 2 Press **ENTER/OK**.
- 3 Press **▲▼** to highlight your selection and press **ENTER/OK**.

## Time display (CD)

Each time you press **ON SCREEN**, the time display changes as follows;

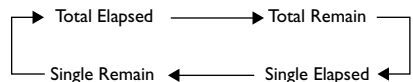

**TIPS:** The operating features described here might not be possible for certain discs. Always refer to the instructions supplied with the discs.



## Special DVD Features

### Playing a Title

- 1 Press **MENU**.  
→ The disc title menu appears on the TV screen.
- 2 Use **◀▶▲▼** or **numeric keypad (0-9)** to select a play option.
- 3 Press **ENTER/OK** to confirm.

### Camera Angle

- Press **ANGLE** repeatedly to select different desired angle.

### Audio

#### Changing the Audio Language and/or format

- Press **AUDIO** repeatedly to select different audio languages.

### Subtitles

- Press **SUBTITLE** repeatedly to select different subtitle languages.

## Special VCD & SVCD Features

### Playback Control (PBC)

#### For VCD with Playback Control (PBC) feature (version 2.0 only)

- Press **MENU** to toggle between 'PBC ON' and 'PBC OFF'.
- If you select 'PBC ON', the disc menu (if available) will appear on the TV.
- Use the **◀◀ / ▶▶** or the **numeric keypad (0-9)** to select a play option.
- During playback, pressing **TOP MENU/RETURN** will return to the menu screen (if PBC is on).

#### If you want to skip the index menu and playback directly from the beginning,

- Press **MENU** on the remote control to switch to PBC off.

### Preview Function

- 1 Press **SCAN**.
- 2 Press **▲▼** to highlight {TRACK DIGEST}, {DISC INTERVAL} or {TRACK INTERVAL}.
- 3 Press **ENTER/OK** to open one option.

```
SELECT DIGEST TYPE:
TRACK DIGEST
DISC INTERVAL
TRACK INTERVAL
```

#### Note:

- You can select {TRACK INTERVAL} only during playback, with PBC Off.

**TIPS:** The operating features described here might not be possible for certain discs. Always refer to the instructions supplied with the discs.

# Disc Operations

## TRACK DIGEST

This function will minimize the picture of every track in order to display every six of these tracks on the screen to help you know the content of every track on the disc.

## DISC INTERVAL

This function is used to divide a disc into six parts by regular intervals and display them on one page to preview the whole disc.

## TRACK INTERVAL

This function is used to divide a single track into six parts by regular intervals and display them on one page to help you preview the selected track.



(example for 6 thumbnail pictures display)

- Use **◀▶▲▼** to select a track or use **numeric keypad (0-9)** to input the selected track number next to {SELECT}.
- Press **◀◀ / ▶▶** to open the previous or next page.
- Press **ENTER/OK** to confirm.

### To quit preview function

- Use **◀▶▲▼** to highlight {EXIT} and press **ENTER/OK** to confirm.

### To return to preview menu

- Use **◀▶▲▼** to highlight {MENU} and press **ENTER/OK** to confirm.

### For CD

- At stop mode, press **SCAN** on the remote control.
- Each track will be played for a few seconds.

## Playing MP3/DivX/JPEG/Kodak Picture CD

### General Operation

- Load a disc.
  - The disc reading time may exceed 30 seconds due to the complexity of the directory/file configuration.
  - The data disc menu appears on the TV screen.
- Playback will start automatically. If not press **PLAY ▶**.



### During playback, you can;

- Press **◀◀ / ▶▶** to select another track/file in the current folder.
- Press **||** to pause playback.

### Helpful Hint:

- It may not be possible to play certain MP3/JPEG/DivX/MPEG-4 disc due to the configuration and characteristics of the disc or condition of the recording.

**TIPS:** The operating features described here might not be possible for certain discs. Always refer to the instructions supplied with the discs.

## Selecting a folder and track/file

- 1 Press **▲▼** to select the folder and press **ENTER/OK** to open the folder.
- 2 Press **▲▼** to select a track/file.
- 3 Press **ENTER/OK** to confirm.  
→ Playback will start from the selected file to the end of the folder.

## Repeat and Shuffle

When the Picture CD/MP3 CD menu is shown on the screen;

- Press **REPEAT** continuously to access different 'Play Mode'.  
→ **FOLDER**: files will be played back once.  
→ **REPEAT ONE**: one file being played repeatedly.  
→ **REPEAT FOLDER**: all files in one folder being played repeatedly.  
→ **SHUFFLE**: all files in the current folder being played at random order.

## Special picture disc features

- 1 Load a Picture disc (Kodak Picture CD, JPEG).  
→ For Kodak disc, the slide show will begin.  
→ For JPEG disc, the picture menu appears on the TV screen.
- 2 Press **PLAY ►** to start the slide-show playback.

## Preview Function (JPEG)

This function shows the content of the current folder or the whole disc.

- 1 Press **STOP ■** during playback.  
→ 12 thumbnail pictures will appear on the TV screen.



- 2 Press **◀◀ / ▶▶** to display the other pictures on the previous/next page.
- 3 Use **◀▶▲▼** to highlight one of the picture and press **ENTER/OK** to start playback *OR*  
Move the cursor to highlight  on the bottom of the page to start playback from the first picture on the current page.
- 4 Press **MENU** to return to Picture CD menu.

**TIPS:** The operating features described here might not be possible for certain discs. Always refer to the instructions supplied with the discs.

# Disc Operations

---

---

## Zoom picture

- 1 During playback, press **ZOOM** repeatedly to display the picture with different scales.
- 2 Use ◀▶▲▼ to view the zoomed picture.

---

## Playback with multi-angles

- During playback, press ◀▶▲▼ to rotate the picture on the TV screen.
  - ◀: rotate the picture anti-clockwise
  - ▶: rotate the picture clockwise
  - ▲: flip the picture vertically
  - ▼: flip the picture horizontally

---

## Scan Effect

- Press **ANGLE** repeatedly to choose different scan effect.
- Various of scan effect appears on the top left hand corner on the TV screen.

---

## Playing MP3 music and JPEG picture simultaneously

- 1 Load a disc that contains music and picture.
  - The disc menu appears on the TV screen.
- 2 Select an MP3 track.
- 3 During MP3 music playback, select a picture from the TV screen and press **PLAY ▶**.
  - The picture files will be played back one after another until end of the folder.
- 4 To quit simultaneous playback, press **MENU** followed by **STOP ■**.

### *Helpful Hint:*

- Some files on Kodak or JPEG disc may be distorted during playback due to the configuration and characteristics of the disc.

**TIPS:** The operating features described here might not be possible for certain discs. Always refer to the instructions supplied with the discs.

The setup is carried out via the TV, enabling you to customize the DVD Player to suit your particular requirements.

## General Setup menu

- 1 Press **SETUP**.
- 2 Press **◀▶** to select 'General Setup' icon.
- 3 Press **ENTER/OK** to confirm.

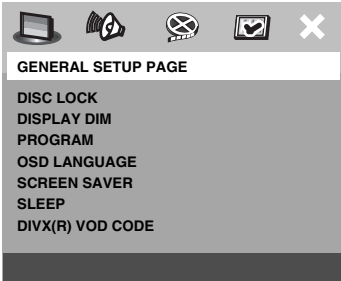

## Locking/Unlocking the disc for viewing

Not all discs are rated or coded by the disc maker. You can prevent a specific disc from playing by locking the disc. Up to 40 discs can be locked.

- 1 In 'GENERAL SETUP PAGE', press **▲▼** to highlight {DISC LOCK}, then press **▶**.

### **LOCK**

Select this to block the playback of the current disc. Subsequent access to a locked disc requires six-digit password. The default password is '000 000' (see page 25 "Changing the Password").

### **UNLOCK**

Select this to unlock the disc and allow future playback.

- 2 Press **▲▼** to select a setting, then press **ENTER/OK** to confirm your selection.

## Dimming player's front panel display

You can select different levels of brightness for the front panel display.

- 1 In 'GENERAL SETUP PAGE', press **▲▼** to highlight {DISPLAY DIM}, then press **▶**.

### **100%**

Select this for full brightness.

### **70%**

Select this for medium brightness.

### **40%**

Select this for dimming the display.

- 2 Press **▲▼** to select a setting, then press **ENTER/OK** to confirm your selection.

## Programming disc tracks (not for Picture CD/MP3)

You can play the contents of the disc in the order you want by programming the tracks to be played. Up to 20 tracks can be stored.

- 1 In 'GENERAL SETUP PAGE', press **▲▼** to highlight {PROGRAM}, then press **▶** to select {INPUT MENU}.
- 2 Press **ENTER/OK** to confirm.

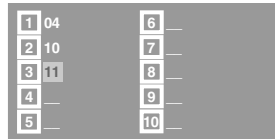

**TIPS:** To return to the previous menu, press **◀**.  
To remove the menu, press **SETUP**.

# Setup Menu

---

## To input your favorite tracks/chapter

- 3 Use the **numeric keypad (0-9)** to enter a valid track/chapter number.
- 4 Use **◀▶▲▼** to move the cursor to the next position.
  - If the track number is more than ten, press **▶▶|** to open the next page and proceed with programming or,
  - Use **◀▶▲▼** to highlight {NEXT} on the program menu, then press **ENTER/OK**.
- 5 Repeat steps 3–4 to input another track/chapter number.

## If you want to remove a track

- 6 Use **◀▶▲▼** to move the cursor to the track you want to remove.
- 7 Press **ENTER/OK** to remove this track from the program menu.

## To start program playback

- 8 Use **◀▶▲▼** to highlight {START} on the program menu, then press **ENTER/OK**.
  - Playback will start with the selected tracks under the programmed sequence.

## To exit program playback

- 9 Use **◀▶▲▼** to highlight {EXIT} on the program menu, then press **ENTER/OK**.

---

## OSD Language

This menu contains various language options for display language on the screen. For details, see page 8.

---

## Screen Saver

This function is used to turn the screen saver on or off.

- 1 In 'GENERAL SETUP PAGE', press **▲▼** to highlight {SCREEN SAVER}, then press **▶**.

### **ON**

Select this if you wish to turn off the TV screen when disc playback is stopped or paused for more than 15 minutes.

### **OFF**

Select this to disable the screen saver function.

- 2 Press **▲▼** to select a setting, then press **ENTER/OK** to confirm your selection.

---

## Sleep Timer

This feature automatically sets the DVD player in standby mode after the amount of time you have set.

- 1 In 'GENERAL SETUP PAGE', press **▲▼** to highlight {SLEEP}, then press **▶**.
- 2 Press **▲▼** to select a setting.
  - You can select from 15, 30, 45 and 60 minutes. Select {OFF} to cancel the sleep timer function.
- 3 Press **ENTER/OK** to confirm your selection.

**TIPS:** To return to the previous menu, press **◀**.  
To remove the menu, press **SETUP**.

## DivX® VOD registration code

Yamaha provide you with the DivX® VOD (Video On Demand) registration code that allows you to rent and purchase videos using the DivX® VOD service.

For more information, visit at [www.divx.com/vod](http://www.divx.com/vod).

- 1 In 'GENERAL SETUP PAGE', press ▲▼ to highlight {DIVX(R) VOD CODE}, then press ►.  
→ The registration code will appear.
- 2 Press **ENTER/OK** to exit.
- 3 Use the registration code to purchase or rent the videos from DivX® VOD service at [www.divx.com/vod](http://www.divx.com/vod). Follow the instructions and download the video onto a CD-R for playback on this DVD player.

### Helpful Hints:

- All the downloaded videos from DivX® VOD can only be played back on this DVD player.
- Time search feature is not available during DivX movie playback.

## Audio Setup Menu

- 1 Press **SETUP**.
- 2 Press ◀▶ to select 'Audio Setup' icon.
- 3 Press **ENTER/OK** to confirm.

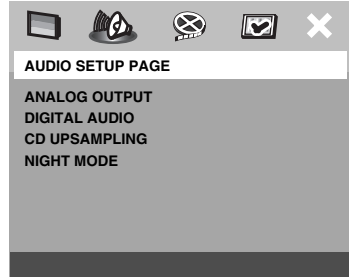

## Setting the analog output

Set Analog Output to match your DVD Player's playback capability.

- 1 In 'AUDIO SETUP PAGE', press ▲▼ to highlight {ANALOG OUTPUT}, then press ►.

### STEREO

Select this to change channel output to stereo which delivers sound from only the two front speakers.

### LT/RT

Select this if your DVD player is connected to a Dolby Prologic decoder.

### VIRTUAL SURROUND

Select this to reproduce the surround channels virtually.

- 2 Press ▲▼ to select a setting, then press **ENTER/OK** to confirm your selection.

**TIPS:** To return to the previous menu, press ◀.  
To remove the menu, press **SETUP**.

# Setup Menu

---

## **Setting the Digital output**

The options included in Digital Audio are: 'Digital Output' and 'LPCM Output'.

- 1 In 'AUDIO SETUP PAGE', press ▲▼ to highlight {DIGITAL AUDIO}, then press ►.
- 2 Press the ▲▼ to highlight an option.
- 3 Enter its submenu by pressing ►.
- 4 Move the cursor by pressing the ▲▼ to highlight the selected item.

## **DIGITAL OUTPUT**

Set the Digital output according to your optional audio equipment connection.

### **OFF**

Turn off the digital output.

### **ALL**

If you have connected your DIGITAL AUDIO OUT to a multi-channel decoder/receiver.

### **PCM ONLY**

Only if your receiver is not capable of decoding multi-channel audio.

## **LPCM OUTPUT**

If you connect the DVD Player to a PCM compatible receiver via the digital terminals, such as coaxial or optical etc., you may need to adjust 'LPCM Output'. Discs are recorded at a certain sampling rate. The higher the sampling rate, the better the sound quality.

### **48K**

Playback a disc recorded at the sampling rate of 48kHz. 96kHz (if available on disc) PCM data stream will be converted to 48kHz.

### **96K**

Playback a disc recorded at the sampling rate of 96kHz. If the 96kHz disc is copy protected, the digital output will be muted to comply with the standards.

---

## **CD Upsampling**

This feature allows you to convert your music CD to a higher sampling rate using sophisticated digital signal processing for better sound quality. If you have activated the upsampling, the player will automatically switch to stereo mode.

- 1 In 'AUDIO SETUP PAGE', press ▲▼ to highlight {CD UPSAMPLING}, then press ►.

### **OFF**

Select this to disable CD-upsampling.

### **88.2 kHz (X2)**

Select this to convert the sampling rate of the CDs twice higher than the original.

### **176.4 kHz (X4)**

Select this to convert the sampling rate of the CDs four times higher than the original.

- 2 Press ▲▼ to select a setting, then press **ENTER/OK** to confirm your selection.

Note:

- This setting is only applicable for the signals output from the analog jacks.

**TIPS:** To return to the previous menu, press ◀.  
To remove the menu, press **SETUP**.



## Night Mode

In this mode, the high volume outputs are softened and low volume outputs are brought upward to an audible level. It is useful for watching your favorite action movie without disturbing others at night.

- 1 In 'AUDIO SETUP PAGE', press ▲▼ to highlight {NIGHT MODE}, then press ►.

### ON

Select this to level out the volume. This feature is only available for movies with Dolby Digital mode.

### OFF

Select this when you want to enjoy the surround sound with its full dynamic range.

- 2 Press ▲▼ to select a setting, then press **ENTER/OK** to confirm your selection.

## Video Setup Menu

- 1 Press **SETUP**.
- 2 Press ◀▶ to select 'Video Setup' icon.
- 3 Press **ENTER/OK** to confirm.



## Setting the TV Display

Set the aspect ratio of the DVD Player according to the TV you have connected. The format you select must be available on the disc. If it is not, the setting for TV display will not affect the picture during playback.

- 1 In 'VIDEO SETUP PAGE', press ▲▼ to highlight {TV DISPLAY}, then press ►.
- 2 Press ▲▼ to highlight one of the options below:

### 4:3 PAN SCAN

Select this if you have a normal TV and want both sides of the picture to be trimmed or formatted to fit your TV screen.

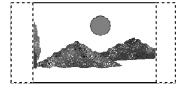

### 4:3 LETTER BOX

Select this if you have a normal TV. In this case, a wide picture with black bands on the upper and lower portions of the TV screen will be displayed.



### 16:9

Select this if you have a widescreen TV.

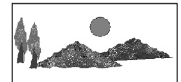

- 3 Select an item and press **ENTER/OK**.

## TV Type

This menu contains the options for selecting the color system that matches the connected TV. For details, see page 7.

**TIPS:** To return to the previous menu, press ◀.  
To remove the menu, press **SETUP**.

# Setup Menu

## Progressive

This feature is only applicable if you have connected this DVD Player to a Progressive Scan TV through the Y Pb Pr jacks (see page 6).

- 1 In 'VIDEO SETUP PAGE', press ▲▼ to highlight {PROGRESSIVE}, then press ►.

### OFF

To disable Progressive Scan function.

### ON

To enable Progressive Scan function.

- 2 Press ▲▼ to select a setting, then press **ENTER/OK** to confirm your selection.

### Notes on activating Progressive:

- Ensure that your TV has progressive scan.
- Connect with YPbPr video cable.

CONSUMERS SHOULD NOTE THAT NOT ALL HIGH DEFINITION TELEVISION SETS ARE FULLY COMPATIBLE WITH THIS PRODUCT AND MAY CAUSE ARTIFACTS TO BE DISPLAYED IN THE PICTURE. IN CASE OF 525 OR 625 PROGRESSIVE SCAN PICTURE PROBLEMS, IT IS RECOMMENDED THAT THE USER SWITCH THE CONNECTION TO THE "STANDARD DEFINITION" OUTPUT. IF THERE ARE QUESTIONS REGARDING OUR VIDEO MONITOR COMPATIBILITY WITH THIS MODEL 525P AND 625P DVD PLAYER, PLEASE CONTACT OUR CUSTOMER SERVICE CENTER.

This unit is compatible with the complete line of YAMAHA products, including the projectors DPX-1000, LPX-510 and the plasma monitor PDM-4210E.

## Picture Setting

This DVD Player provides three predefined sets of picture color settings and one personal setting which you can define yourself.

- 1 In 'VIDEO SETUP PAGE', press ▲▼ to highlight {PICTURE SETTING}, then press ►.

### STANDARD

Select this for standard picture setting.

### BRIGHT

Select this will make the TV picture brighter.

### SOFT

Select this will make the TV picture softer.

### PERSONAL

Select this to personalize your picture color by adjusting the brightness, contrast, tint and color (saturation).

- 2 Press ▲▼ to select a setting, then press **ENTER/OK** to confirm your selection.
- 3 If you select {PERSONAL}, then proceed to steps 4–7.

→ The 'PERSONAL PICTURE SETUP' menu appears.

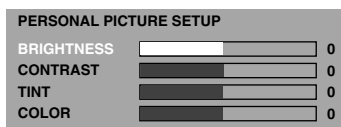

**TIPS:** To return to the previous menu, press ◀.  
To remove the menu, press **SETUP**.

- 4 Press **▲▼** to highlight one of the following options.

### **BRIGHTNESS**

Increase the value will brighten the picture or vice versa. Choose zero (0) for average setting.

### **CONTRAST**

Increase the value will sharpen the picture or vice versa. Choose zero (0) to balance the contrast.

### **TINT**

Increase the value will darken the picture or vice versa. Choose zero (0) for average setting.

### **COLOR**

Increase the value will enhance the color in your picture or vice versa. Choose zero (0) to balance the color.

- 5 Press **◀▶** to adjust the setting that best suit your personal preference.
- 6 Repeat steps 4–5 for adjusting other color features.
- 7 Press **ENTER/OK** to confirm.

## **Switching the YUV/RGB**

This setting allows you to toggle the output of the video signal between RGB (on scart) and Y Pb Pr (YUV).

- 1 In 'VIDEO SETUP PAGE', press **▲▼** to highlight {COMPONENT}, then press **▶**.

### **YUV**

Select this for Y Pb Pr connection.

### **RGB**

Select this for Scart connection.

- 2 Press **▲▼** to select a setting, then press **ENTER/OK** to confirm your selection.

**TIPS:** To return to the previous menu, press **◀**.  
To remove the menu, press **SETUP**.

# Setup Menu

## Preference Setup Menu

- 1 Press **STOP** ■ twice to stop playback (if any), then press **SETUP**.
- 2 Press ◀▶ to select the 'Preference Setup' icon.
- 3 Press **ENTER/OK** to confirm.

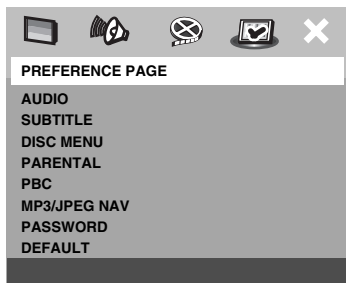

## Audio, Subtitle, Disc Menu

These menus contain various language options for audio, subtitle and disc menu which may be recorded on the DVD. For details, see page 9.

## Restricting playback by Parental Control

Some DVDs may have a parental level assigned to the complete disc or to certain scenes on the disc. This feature lets you set a playback limitation level.

The rating levels are from 1 to 8 and are country dependent. You can prohibit the playing of certain discs that are not suitable for your children or have certain discs played with alternative scenes.

- 1 In 'PREFERENCE PAGE', press ▲▼ to highlight {PARENTAL}, then press ▶.

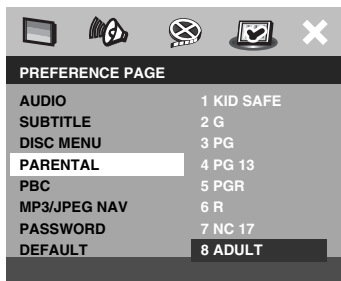

- 2 Press ▲▼ to highlight a rating level for the disc inserted and press **ENTER/OK**.  
→ To disable Parental controls and have all Discs play, select {8 ADULT}.
- 3 Use the **numeric keypad (0-9)** to enter the six-digit password (see page 25 "Changing the Password").  
→ DVDs that are rated above the level you selected will not play unless you enter your six-digit password.

### Helpful Hints:

- VCD, SVCD, CD have no level indication, so parental control function has no effect on these type of discs. This applies to most illegal DVD discs.
- Some DVDs are not encoded with a rating though the movie rating may be printed on the Disc cover. The rating level feature does not work for such Discs.

## PBC (Playback Control)

You can set the PBC to ON or OFF. This feature is available only on Video CD 2.0 with playback control (PBC) feature. For details, see page 13.

**TIPS:** To return to the previous menu, press ◀.  
To remove the menu, press **SETUP**.

## MP3/JPEG Menu

MP3/JPEG Navigator can be set only if the disc is recorded with menu. It allows you to select different display menus for easy navigation.

- 1 In 'PREFERENCE PAGE', press ▲▼ to highlight {MP3/JPEG NAV}, then press ►.

### WITHOUT MENU

Select this to display all the files contained in the MP3/Picture CD.

### WITH MENU

Select this to display only the folder menu of the MP3/Picture CD.

- 2 Press ▲▼ to select a setting, then press **ENTER/OK** to confirm your selection.

## Changing the Password

The same password is used for both Parental Control and Disc Lock. Enter your six-digit password when prompted on the screen. The default password is 000 000.

- 1 In 'PREFERENCE PAGE', press ▲▼ to highlight {PASSWORD}, then press ► to select {CHANGE}.

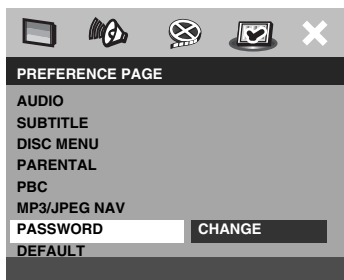

- 2 Press **ENTER/OK** to enter the 'Password Change Page'.

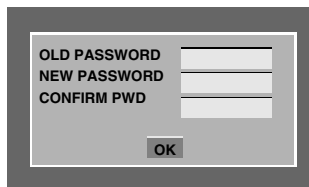

- 3 Use the **numeric keypad (0-9)** to enter your old six-digit password.
  - When doing this for the first time, key in '000 000'.
  - If you forget your old six-digit password, key in '000 000'.
- 4 Enter the new six-digit password.
- 5 Enter the new six-digit password a second time to confirm.
  - The new six-digit password will now take effect.
- 6 Press **ENTER/OK** to confirm.

## Restoring to original settings

Setting the DEFAULT function will reset all options and your personal settings to the factory defaults, except your password for Parental Control and Disc Lock.

- 1 In 'PREFERENCE PAGE', press ▲▼ to highlight {DEFAULT}, then press ► to select {RESET}.
- 2 Press **ENTER/OK** to confirm.
  - All settings will now reset to factory defaults.

**TIPS:** To return to the previous menu, press ◀.  
To remove the menu, press **SETUP**.

# Language Code

These pages can be used to select other languages. This does not affect the options in "AUDIO", "SUBTITLE" or "DISC MENU".

Abkhazian	6566	German	6869
Afar	6565	Gikuyu; Kikuyu	7573
Afrikaans	6570	Greek,	6976
Albanian	8381	Guarani	7178
Amharic	6577	Gujarati	7185
Arabic	6582	Hausa	7265
Armenian	7289	Hebrew	7269
Assamese	6583	Herero	7290
Avestan	6569	Hindi	7273
Aymara	6589	Hiri Motu	7279
Azerbaijani	6590	Hungarian	7285
Bashkir	6665	Icelandic	7383
Basque	6985	Ido	7379
Belarusian	6669	Indonesian	7368
Bengali	6678	Interlingua (International)	7365
Bihari	6672	Interlingue	7369
Bislama	6673	Inuktitut	7385
Bokmål, Norwegian	7866	Inupiaq	7375
Bosnian	6683	Irish	7165
Breton	6682	Italian	7384
Bulgarian	6671	Japanese	7465
Burmese	7789	Javanese	7486
Castilian, Spanish	6983	Kalaallisut	7576
Catalan	6765	Kannada	7578
Chamorro	6772	Kashmiri	7583
Chechen	6769	Kazakh	7575
Chewa; Chichewa; Nyanja	7889	Khmer	7577
Chichewa; Chewa; Nyanja	7889	Kikuyu; Gikuyu	7573
Chinese	9072	Kinyarwanda	8287
Chuang; Zhuang	9065	Kirghiz	7589
Church Slav; Slavonic;	6785	Komi	7586
Church Slavonic; Church	6785	Korean	7579
Chuvash	6786	Kwanyama; Kwanyama	7574
Cornish	7587	Kurdish	7585
Corsican	6779	Kwanyama; Kwanyama	7574
Croatian	7282	Lao	7679
Czech	6783	Latin	7665
Danish	6865	Latvian	7686
Dutch	7876	Letzeburgesch;	7666
Dzongkha	6890	Limburgan; Limburger;	7673
English	6978	Limburger; Limburgan;	7673
Esperanto	6979	Limburgish; Limburger;	7673
Estonian	6984	Lingala	7678
Faroese	7079	Lithuanian	7684
Fijian	7074	Luxembourgish;	7666
Finnish	7073	Macedonian	7775
French	7082	Malagasy	7771
Frisian	7089	Malay	7783
Gaelic; Scottish Gaelic	7168	Malayalam	7776
Gallegan	7176	Maltese	7784
Georgian	7565	Manx	7186

These pages can be used to select other languages. This does not affect the options in "AUDIO", "SUBTITLE" or "DISC MENU".

Maori	7773	Sotho, Southern	8384
Marathi	7782	South Ndebele	7882
Marshallese	7772	Spanish; Castilian	6983
Moldavian	7779	Sundanese	8385
Mongolian	7778	Swahili	8387
Nauru	7865	Swati	8383
Navaho, Navajo	7886	Swedish	8386
Navajo; Navaho	7886	Tagalog	8476
Ndebele, North	7868	Tahitian	8489
Ndebele, South	7882	Tajik	8471
Ndonga	7871	Tamil	8465
Nepali	7869	Tatar	8484
Northern Sami	8369	Telugu	8469
North Ndebele	7868	Thai	8472
Norwegian	7879	Tibetan	6679
Norwegian Bokmål; Bokmål,	7866	Tigrinya	8473
Norwegian Nynorsk;	7878	Tonga (Tonga Islands)	8479
Nyanja; Chichewa; Chewa	7889	Tsonga	8483
Nynorsk, Norwegian;	7878	Tswana	8478
Occitan (post 1500); Proven	7967	Turkish	8482
Old Bulgarian; Old Slavonic;	6785	Turkmen	8475
Old Church Slavonic; Old	6785	Twi	8487
Old Slavonic; Church	6785	Uighur	8571
Oriya	7982	Ukrainian	8575
Oromo	7977	Urdu	8582
Ossetian; Ossetic	7983	Uzbek	8590
Ossetic; Ossetian	7983	Vietnamese	8673
Pali	8073	Volapük	8679
Panjabi	8065	Walloon	8765
Persian	7065	Welsh	6789
Polish	8076	Wolof	8779
Portuguese	8084	Xhosa	8872
Provençal; Occitan (post)	7967	Yiddish	8973
Pushto	8083	Yoruba	8979
Quechua	8185	Zhuang; Chuang	9065
Raeto-Romance	8277	Zulu	9085
Romanian	8279		
Rundi	8278		
Russian	8285		
Samoan	8377		
Sango	8371		
Sanskrit	8365		
Sardinian	8367		
Scottish Gaelic; Gaelic	7168		
Serbian	8382		
Shona	8378		
Sindhi	8368		
Sinhalese	8373		
Slovak	8375		
Slovenian	8376		
Somali	8379		

# Troubleshooting

Refer to the chart below when this unit does not function properly. If the problem you are experiencing is not listed below or if the instruction below does not help, set this unit to the standby mode, disconnect the power cord, and contact the nearest authorized YAMAHA dealer or service center.

Problem	Solution
<b>No power</b>	<ul style="list-style-type: none"><li>– Check if the AC power cord is properly connected.</li><li>– Press the STANDBY/ON on the front of the DVD system to turn on the power.</li></ul>
<b>No picture</b>	<ul style="list-style-type: none"><li>– Refer to your TV's manual for correct Video In channel selection. Change the TV channel until you see the DVD screen.</li><li>– Check if the TV is switched on.</li></ul>
<b>Distorted picture</b>	<ul style="list-style-type: none"><li>– Sometimes a small amount of picture distortion may appear depending on the disc being played back. This is not a malfunction.</li></ul>
<b>Completely distorted picture or black/white picture with DVD</b>	<ul style="list-style-type: none"><li>– Make sure the disc is compatible with the DVD Player.</li><li>– Ensure that the DVD Player's TV Type is set to match that of the Disc and your TV.</li></ul>
<b>No sound or distorted sound</b>	<ul style="list-style-type: none"><li>– Adjust the volume.</li><li>– Check that the speakers are connected correctly.</li></ul>
<b>No audio at digital output</b>	<ul style="list-style-type: none"><li>– Check the digital connections.</li><li>– Check if your receiver can decode MPEG-2 or DTS and if not, please make sure the digital output is set to PCM ONLY.</li><li>– Check if the audio format of the selected audio language matches your receiver capabilities.</li></ul>
<b>No sound and picture</b>	<ul style="list-style-type: none"><li>– Check that the RGB/SCART cable is connected to the correct device (See "Video Connections").</li></ul>
<b>Disc can't be played</b>	<ul style="list-style-type: none"><li>– The DVD+R/RW, DVD-R/RW, CD-R/RW must be finalized.</li><li>– Ensure the disc label is facing up.</li><li>– Check if the disc is defective by trying another disc.</li><li>– If you have recorded a Picture CD or MP3 CD yourself, ensure that your disc contains at least 10 pictures or 5 MP3 tracks.</li><li>– Region code incorrect.</li></ul>
<b>Picture freezes momentarily during playback</b>	<ul style="list-style-type: none"><li>– Check the disc for fingerprints/scratches and clean with a soft cloth wiping from centre to edge.</li></ul>
<b>The player does not respond to the Remote Control</b>	<ul style="list-style-type: none"><li>– Aim the Remote Control directly at the sensor on the front of the player.</li><li>– Reduce the distance to the player.</li><li>– Replace the batteries in the Remote Control.</li><li>– Re-insert the batteries with their polarities (+/– signs) as indicated.</li></ul>
<b>Buttons do not work</b>	<ul style="list-style-type: none"><li>– To completely reset the player, unplug the AC cord from the AC outlet for 5-10 seconds.</li></ul>



Problem	Solution
<b>Player does not respond to some operating commands during playback.</b>	– Operations may not be permitted by the disc. Refer to the instructions of the disc jacket.
<b>DVD Player cannot read CDs/DVDs</b>	– Use a commonly available cleaning CD/DVD to clean the lens before sending the DVD Player for repair.
<b>Menu items cannot be selected</b>	– Press STOP twice before selecting System Menu. – Depending on the disc availability, some menu items cannot be selected.
<b>Unable to play DivX movies</b>	– Check that the DivX file is encoded in 'Home Theater' mode with DivX 5.x encoder.
<b>Unable to select Progressive Scan on/off</b>	– Check that the output of the video signal is switch to 'YUV'.
<b>No sound during DivX movies playback</b>	– The audio code may not be supported by the DVD player.

# Glossary

---

**Analog:** Sound that has not been turned into numbers. Analog sound varies, while digital sound has specific numerical values. These jacks send audio through two channels, the left and right.

**Aspect ratio:** The ratio of vertical and horizontal sizes of a displayed image. The horizontal vs. vertical ratio of conventional TVs is 4:3, and that of wide-screens is 16:9.

**AUDIO OUT Jacks:** Jacks on the back of the DVD System that send audio to another system (TV, Stereo, etc.).

**Bit Rate:** The amount of data used to hold a given length of music; measured in kilobits per seconds, or kbps. Or, the speed at which you record. Generally, the higher the bit rate, or the higher the recording speed, the better the sound quality. However, higher bit rates use more space on a Disc.

**Chapter:** Sections of a picture or a music piece on a DVD that are smaller than titles. A title is composed of several chapters. Each chapter is assigned a chapter number enabling you to locate the chapter you want.

**Component Video Out Jacks:** Jacks on the back of the DVD System that send high-quality video to a TV that has Component Video In jacks (R/G/B, Y/Pb/Pr, etc.).

**Disc menu:** A screen display prepared for allowing selection of images, sounds, subtitles, multi-angles, etc. recorded on a DVD.

**Digital:** Sound that has been converted into numerical values. Digital sound is available when you use the DIGITAL AUDIO OUT COAXIAL or OPTICAL jacks. These jacks send audio through multiple channels, instead of just two channels as analog does.

**DivX 3.11/4x/5x:** The DivX code is a patent pending, MPEG-4 based video compression technology, developed by DivX Networks, Inc., that can shrink digital video to sizes small enough to be transported over the internet, while maintaining high visual quality.

**Dolby Digital:** A surround sound system developed by Dolby Laboratories containing up to six channels of digital audio (front left and right, surround left and right, center and subwoofer).

**DTS:** Digital Theatre Systems. This is a surround sound system, but it is different from Dolby Digital. The formats were developed by different companies.

**JPEG:** A very common digital still picture format. A still-picture data compression system proposed by the Joint Photographic Expert Group, which features small decrease in image quality in spite of its high compression ratio.

**MP3:** A file format with a sound data compression system. "MP3" is the abbreviation of Motion Picture Experts Group 1 (or MPEG-1) Audio Layer 3. By using MP3 format, one CD-R or CD-RW can contain about 10 times as much data volume as a regular CD can.

**Parental Control:** A function of the DVD to limit playback of the disc by the age of the users according to the limitation level in each country. The limitation varies from disc to disc; when it is activated, playback will be prohibited if the software's level is higher than the user-set level.

**PCM (Pulse Code Modulation):** A system for converting analog sound signal to digital signal for later processing, with no data compression used in conversion.

**Playback control (PBC):** Refers to the signal recorded on video CDs or SVCDs for controlling reproduction. By using menu screens recorded on a Video CD or SVCD that supports PBC, you can enjoy interactive-type software as well as software having a search function.

**Progressive Scan:** It displays all the horizontal lines of a picture at one time, as a signal frame. This system can convert the interlaced video from DVD into progressive format for connection to a progressive display. It dramatically increases the vertical resolution.

**Region code:** A system for allowing discs to be played back only in the region designated beforehand. This unit will only play discs that have compatible region codes. You can find the region code of your unit by looking on the product label. Some discs are compatible with more than one region (or ALL regions).

**S-Video:** Produces a clear picture by sending separate signals for the luminance and the color. You can use S-Video only if your TV has S-video In jack.

**Surround:** A system for creating realistic three dimensional sound fields full of realism by arranging multiple speakers around the listener.

**Title:** The longest section of a picture or music feature on DVD, music, etc., in video software, or the entire album in audio software. Each title is assigned a title number enabling you to locate the title you want.

**VIDEO OUT jack:** Jack on the back of the DVD System that sends video to a TV.

## PLAYBACK SYSTEM

DVD Video  
 Video CD & SVCD  
 CD  
 PICTURE CD  
 CD-R, CD-RW  
 DVD+R, DVD+RW  
 DVD-R, DVD-RW

## VIDEO PERFORMANCE

Video (CVBS) Output 1 Vpp into 75 ohm  
 S-Video output Y: 1 Vpp into 75 ohm  
 C: 0.3 Vpp into 75 ohm  
 RGB (SCART) output 0.7 Vpp into 75 ohm  
 Component video output Y: 1 Vpp into 75 ohm  
 Pb/Cb Pr/Cr: 0.7 Vpp into 75 ohm

## AUDIO FORMAT

Digital	Mpeg/ Dolby Digital/ DTS	Compressed Digital
	PCM	16, 20, 24 bits fs, 44.1, 48, 96 kHz
	MP3(ISO 9660)	24, 32, 56, 64, 96, 128, 256 kbps fs, 16, 22.05, 24, 32, 44.1, 48 kHz
	WMA	32 kbps-192 kbps, mono, stereo

Analog Sound Stereo

## LASER

Type	Semiconductor laser GaAlAs
Wave length	650 nm (DVD) 780 nm (VCD/CD)
Output Power	7 mW (DVD) 10 mW (VCD/CD)
Beam divergence	60 degree

## AUDIO PERFORMANCE

DA Converter	24bit
Signal-Noise (1 kHz)	105dB
Dynamic range (1 kHz)	100dB
DVD	fs 96 kHz 2Hz- 44kHz fs 48 kHz 2Hz- 22kHz
SVCD	fs 48 kHz 2Hz- 22kHz fs 44.1kHz 2Hz- 20kHz
CD/VCD	fs 44.1kHz 2Hz- 20kHz
Distortion and Noise (1 kHz)	0.003%

## TV STANDARD (PAL/50Hz) (NTSC/60Hz)

Number of lines	625	525
Playback	Multistandard	(PAL/NTSC)

## CONNECTIONS

SCART	Euroconnector
Y Output	Cinch (green)
Pb/Cb Output	Cinch (blue)
Pr/Cr Output	Cinch (red)
S-Video Output	Mini DIN, 4 pins
Video Output	Cinch
Audio Output (L+R)	Cinch
Digital Output	1 coaxial, 1 optical IEC60958 for CDDA / LPCM/ MPEG1 IEC61937 for MPEG 2, Dolby Digital and DTS

## CABINET

Dimensions (w x d x h)	435 x 310 x 51 mm
Weight	Approx. 2.6 Kg

## POWER SUPPLY

Power inlet	230V, 50Hz
Power usage	Approx. 14W
Power usage standby	< 1W

**Specifications subject to change without prior notice**

## Free Manuals Download Website

<http://myh66.com>

<http://usermanuals.us>

<http://www.somanuals.com>

<http://www.4manuals.cc>

<http://www.manual-lib.com>

<http://www.404manual.com>

<http://www.luxmanual.com>

<http://aubethermostatmanual.com>

Golf course search by state

<http://golfingnear.com>

Email search by domain

<http://emailbydomain.com>

Auto manuals search

<http://auto.somanuals.com>

TV manuals search

<http://tv.somanuals.com>