

**YAMAHA**  
**CS15D**  
**DUAL CHANNEL SYNTHESIZER**  
**OWNER'S MANUAL**

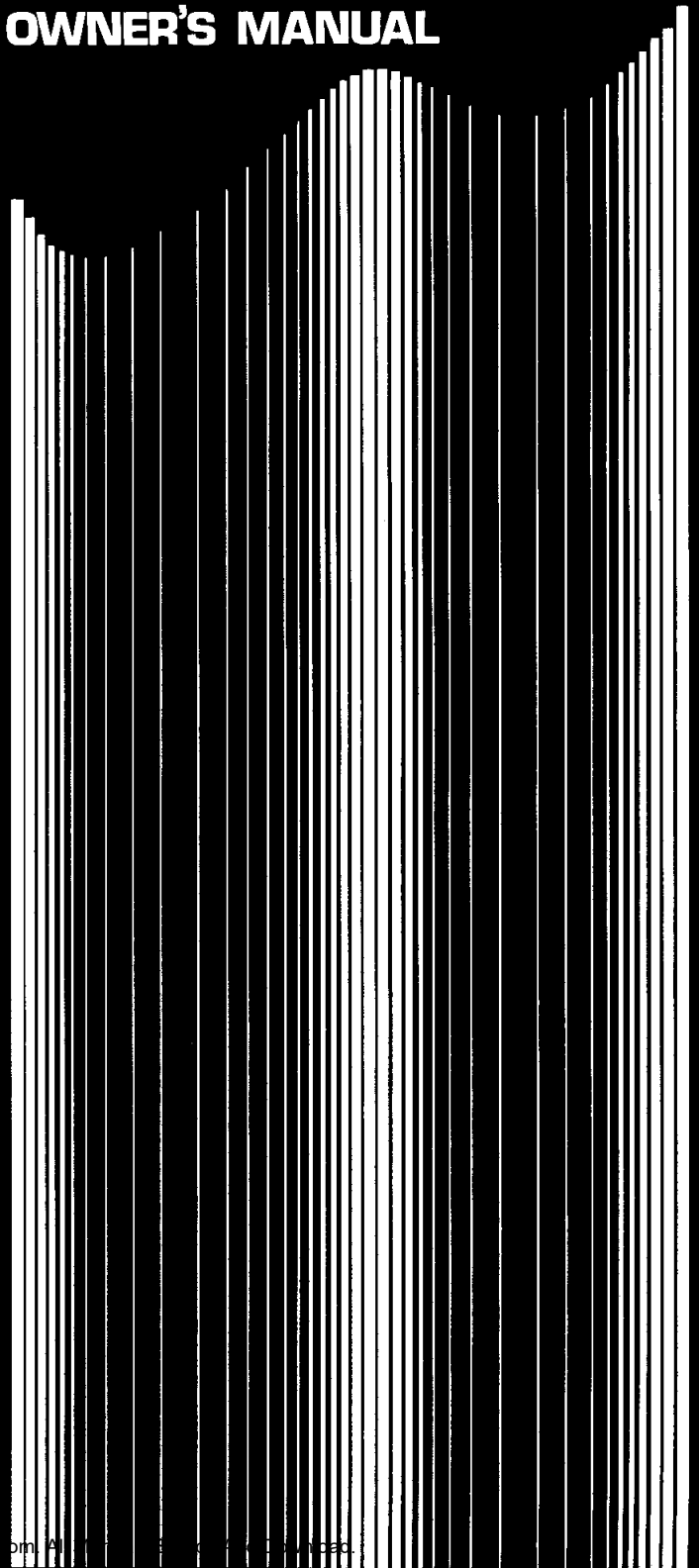

# SYNTHESIZER CS15D

Thank you for your purchase of the YAMAHA SYNTHESIZER CS15D.

Provided with a total of 29 preset tones divided into two channels, plus one manual-control channel, the CS15D is particularly designed to provide improved real-time performing properties while retaining its originality as a synthesizer.

Please read this Owner's Manual carefully to bring out the full potential of the CS15D, making use of its many features.

## ■ Points of attention

### ● Installation

Avoid places subjected to direct sunlight, high humidity, or dust. Never use the synthesizer near fire or heat-producing objects, (such as on the top of a power amplifier), as it will cause cabinet deformation.

### ● Cleaning

When cleaning the set, do not wipe the panel or keyboard with thinner or other cleaning liquids, as this may cause stains and discoloration. Use always a soft and dry piece of cloth.

### ● Connections

Connections to an amplifier or other equipment must be made correctly and with due care, as wrong connections may lead to damaging the synthesizer or amplifier.

### ● Volume

The volume level should be set with care. Applications of excessive input may cause damage to the amplifier or speakers.

Page **5**

## OUTPUT/PITCH/MODULATION

This block accommodates controls with functions able to determine all basic functions of the CS15D.

This block is used, for example to set the basic pitch and to determine the volume. It must be set prior to performing control operations and checks.

Pages **6**, **7**

## PITCH/MODULATION/SUSTAIN PORTAMENTO/BRILLIANCE

This block is used during performances to effect fine control of sounds to give various nuances to them. The controls are operated by the left hand.

The block is effective both for the voices created by the MANUAL block and for all preset voices. As it serves to add final nuances to those voices selected by the VOICE SELECTOR so as to meet your taste, it may be likened to spices used in cooking.

CONTENTS	Page
CONNECTIONS .....	4
OPERATIONS .....	5
CREATING SOUNDS .....	10
FOR FULL UTILIZATION .....	14
SOUND MEMO .....	16
BLOCK DIAGRAM .....	17
SPECIFICATIONS .....	17
TROUBLESHOOTING .....	18

Pages **4**, **15**

**INPUT / OUTPUT Terminals (Rear Panel)**

**LINE OUT**

The synthesizer does not incorporate a power amplifier. Therefore, when playing the synthesizer using speakers, the output of the synthesizer must be connected to a power amplifier such as a keyboard amplifier.

**CONTROL VOLT/TRIGGER**

These are input/output terminals used for exchanging voltage data with another synthesizer to determine the sounds of the synthesizer.

When only one synthesizer unit is to be used, there is no need to use these terminals.

Page **9**

**VOICE SELECTOR**

This block is used for selecting the sounds to be played by the CS15D. Of the 29 preset voices, plus those created by manual operation, desired voices are selected by the push buttons. Volume balancing between Ch-1 and Ch-2 is also performed at this block.



Page **9**

**MANUAL**

This block is used for creating original synthesizer voices. It consists of three blocks: the VCO block, or 'Voltage Controlled Oscillator' which produces signals that serve as sound sources; the VCF block, or 'Voltage Controlled Filter' which creates different timbre of sounds; the VCA block, or 'Voltage Controlled Amplifier' which determines volume variations from the point the voice starts up to the point at which it fades away.

This block becomes operable only when "MANUAL" of Ch-2 is selected by the VOICE SELECTOR.

# CONNECTIONS

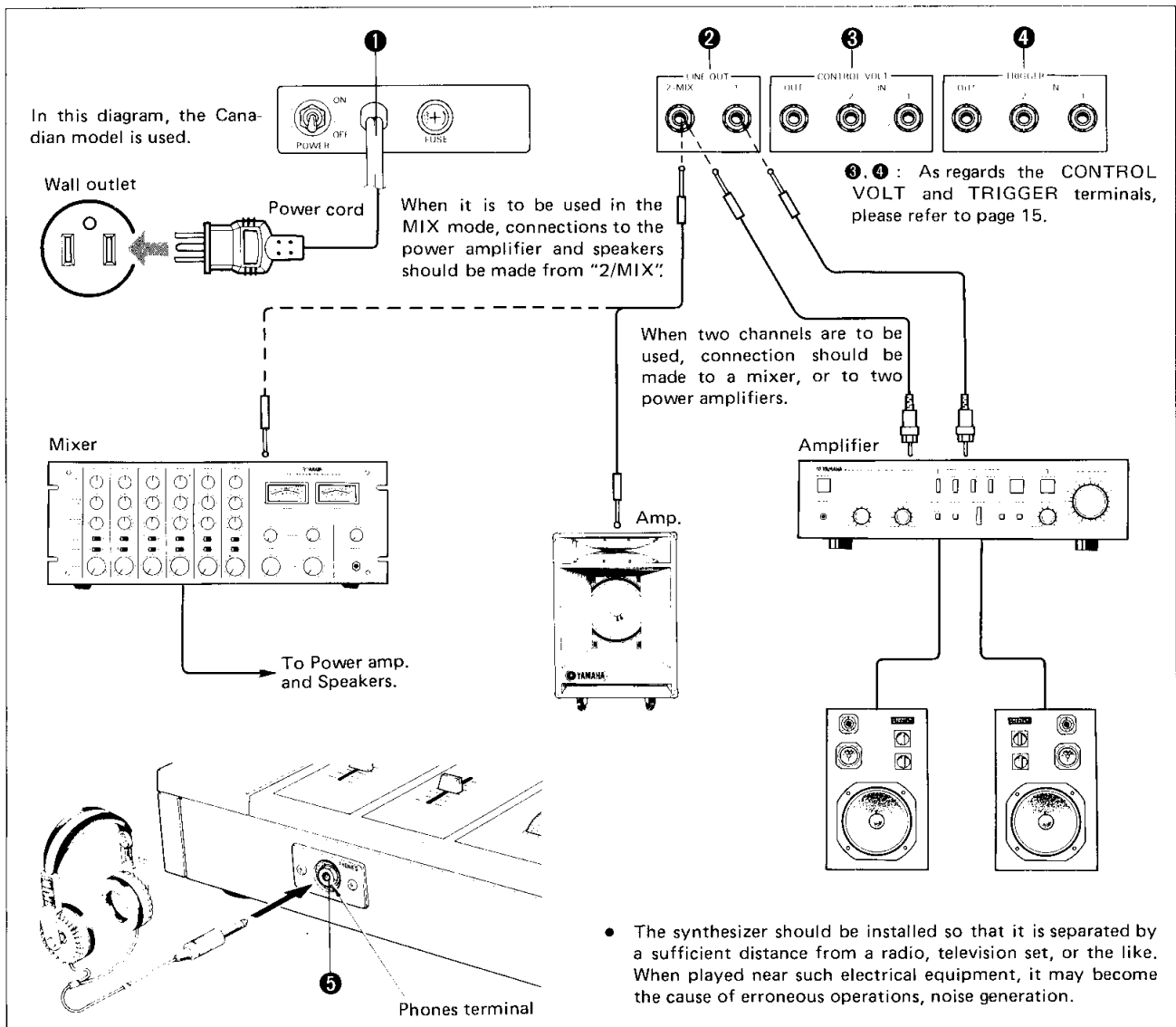

## 1 POWER CORD

Insert the plug into an AC outlet. Power consumption of the CS15D is 25W.

## 2 LINE OUT 1, 2/MIX

These are output terminals used for connecting the synthesizer to the amplifier, or other equipment. "1" feeds out the sounds of Ch-1, "2/MIX" feeds out sounds produced from the mixing of Ch-1 and 2 when no jack is inserted into "1"; it also feeds out those sounds of Ch-2 alone when a jack is inserted into "1".

- When making connection to an amplifier, take special protective measures with regard to the speakers, such as, switching off the amplifier's power switch, or by turning down its volume.

## 3 CONTROL VOLTAGE/4 TRIGGER

These terminals are used for feeding in to, or out from, another synthesizer such data as: (1) the voltage indicating the pitch of the keys that are being played (CONTROL VOLTAGE); and, (2) voltage data indicating the timing for playing and releasing the key (TRIGGER).

By connecting them to another synthesizer, control of multiplex systems can be effected from a single keyboard. For further details, please refer to Page 15.

- Connections should be made most carefully, as it may lead to such serious troubles as damaging the power amplifier, or speakers, when the connector cord for connection to the amplifier is connected to these terminals by mistake.

## 5 PHONES

Phones jack is used for connecting the headphones. Mixed sounds of Ch-1 and Ch-2 will be fed out.

# OPERATIONS/To Produce Sounds

On completion of connections, check them to confirm that no mistake has been made. Now, as we shall describe the functions of the control for each block, operate them yourself while listening to the sounds to confirm the functions.

## Turn on the POWER switch.

### 1 POWER (Power switch)

The power switch is located at the back next to the power cord. Flip this switch up. This will cause power to turn on and the indicator on the upper right side of the control panel to light up.

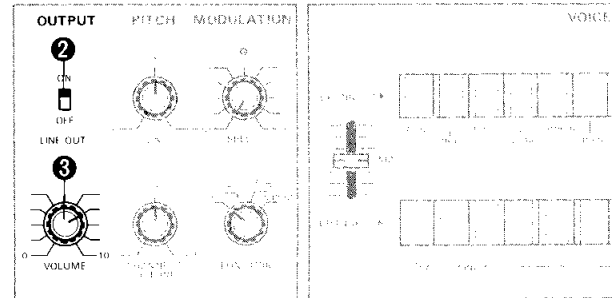
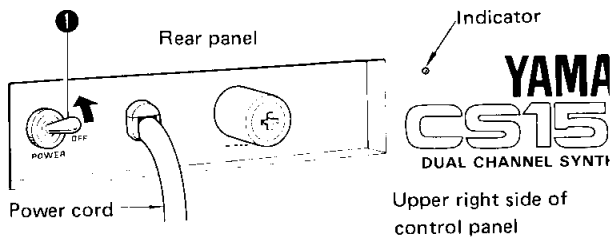

for example, you are creating sounds while using the headphones.

### 3 VOLUME (Volume control)

Turn up the volume. Now the synthesizer can be played by working the keyboard. The volume of the amplifier-side should be adjusted at the same time.

### 4 KEYBOARD

The CS15D covers three octaves with 37 keys.

- When 2 or more keys are depressed simultaneously, priority will be given to the higher-pitched key so that only its sound will be fed out. (Being a monophonic synthesizer in which priority is given to the higher tone.)

When the keyboard is played with the unit set in this condition, the performance will be a dual-tone (clarinet and WOOD WIND 1) performance.

- In the case that no sound comes out, check to see whether connections are correct, whether the amplifier has been operated in the correct manner, and whether the amplifier and speakers are connected properly.
- In the case sufficient volume cannot be obtained, check the input terminal of the amplifier-side to see that connection is proper.
- When audio speakers are used, excessively high volumes may cause the speakers to be damaged by burning. Be sure to use the speakers within their rated power capacity.

## Preliminary Operations

In order to confirm that connections have been made properly, you should now produce the sounds yourself. In preparation for this, the block adjacent to the keyboard should be set as shown in the following drawing.

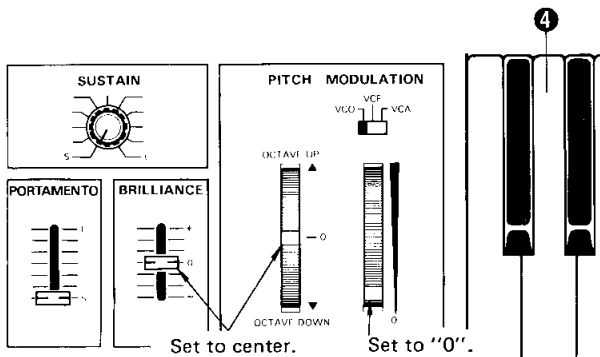

The next step is to select a voice with the VOICE SELECTOR. Let us, for sake of convenience, select the voice at the left end. Set it as shown in the following drawing. With this, preparations have been completed.

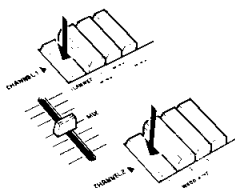

After selecting CLARINET and WOOD WIND 1, fix MIX lever to the center.

## OUTPUT

### 2 LINE OUT (Output switch)

Turn on the switch. This will cause connection between the amplifier and the synthesizer.

This switch should be positioned "OFF" when,

# OPERATIONS/To Change Pitch

Such controls as TUNE/DETUNE/PITCH Bend Wheel are provided to change the pitch.

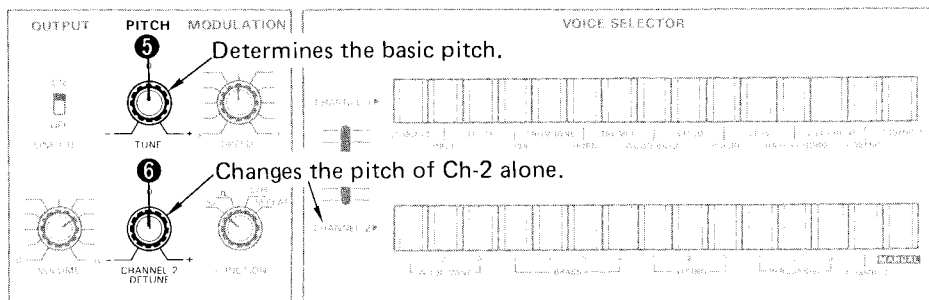

Used for changing the pitch temporarily, chiefly during performances.

## 5 TUNE

This is a tuning control used for tuning the pitch with that of another musical instrument when performing joint performances. When tuning the pitches, be sure to confirm that the PITCH Bend Wheel is at the click-stop position.

- The tuning control is to be used with the mixing lever of the VOICE SELECTOR slid to the upper side, and after selecting the sounds of Ch-1.
- For the synthesizer, it takes about 15 minutes following power switch-on for the pitch to perfectly stabilize. For this reason, tuning is to be performed after more than 15 minutes have passed from the time of power switch-on.

## 6 DETUNE

This is a control used for tuning the pitches of Ch-2 alone. It is possible to gain a chorus effect by producing a slight deviation in the pitches of the two channels, or to create a harmony effect by setting the pitches apart by the third or fifth.

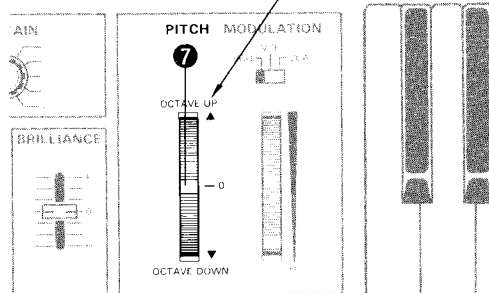

## 7 PITCH (Pitch Bend)

The PITCH bend wheel is to be used when the player wishes to change the pitch temporarily during performances. Normally, it is set to the click-stop position at the center. It is used, for example, to change the pitch according to the rhythm played by the keyboard, and then is swiftly restored to the former click-stop position during rests between sounds.

The range in which the pitch can be changed is  $\pm$  one octave.

### HINT: DETUNE

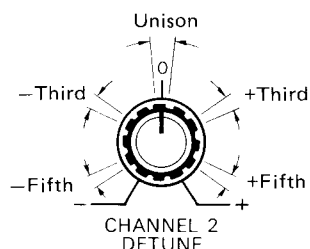

When the pitch of Ch-1 is set so that it deviates from the pitch of Ch-2 by the major third, or perfect fifth, the sounds will be given an increased depth by the harmony effects.

### HINT: PITCH BEND

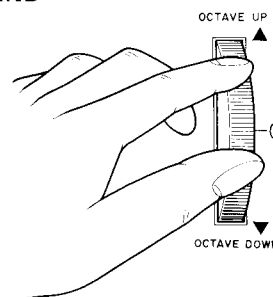

PITCH BEND is used, for example, to create a pitch-changing effect at the point where the tone starts in guitar choking, or in harmonica performances. It is also used for slur performances: while depressing the key with the right hand, the wheel is controlled with the left.

# OPERATIONS/MODULATION

The operation to give a periodical variation to the sounds is known as modulation. Modulation consists of 4 factors: the speed of variation, method of variation, the object of variation, and the intensity of variation; each is set by individual controls.

To confirm the effects of modulation, the 4 controls related to modulation are to be first set as illustrated in the following drawing.

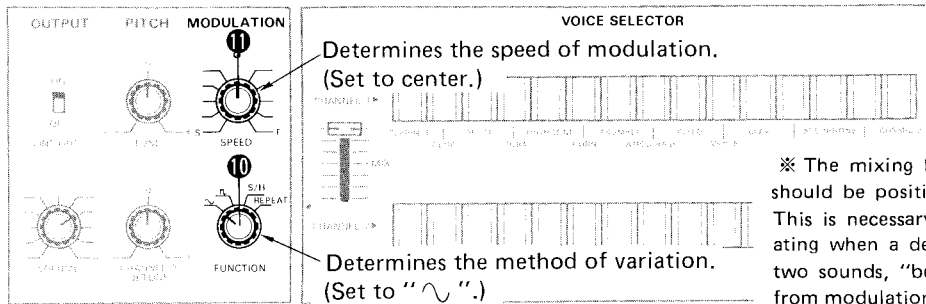

※ The mixing lever of the VOICE SELECTOR should be positioned either to Ch-1, or to Ch-2. This is necessary to prevent "beat" from generating when a deviation occurs in the pitches of two sounds, "beat" being difficult to tell apart from modulation.

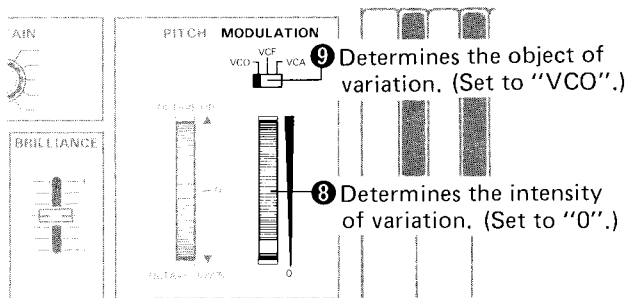

## 10 FUNCTION

This is a switch that determines the mode in which modulation varies. When this switch is positioned to "∩", natural variations will be obtained; such musical effects including VIBRATO, GROWL and TREMOLO described in 9. At other positions the variations will be those inherent to the synthesizer.

∩ : Change the switch over to this position and see how the sounds change. As the form "∩" indicates, rapid variation will be repeated.

S/H: When positioned to "S/H", irregular variation will be repeated.

REPEAT: Unlike the other three functions, REPEAT is effected by controlling the modulation signal, which, in turn, controls the TRIGGER signal that causes the EG to start up. Accordingly, it enables intermittent sounds of a period determined by the SPEED control to be produced while the keyboard is being played.

(Continued)

## 8 MODULATION WHEEL

This wheel functions to control the intensity of modulation. The more the dented portion of the wheel is turned upward, the more intense the modulation will become.

The intensity of modulation can be controlled as desired while playing the keyboard.

Here, it is to be set to the position where the strongest modulation will be applied.

## 9 MODULATION Switch

This is a switch used for selecting which block of the three blocks (VCO, VCF, or VCA) modulation is to be applied. When the switch is positioned to "VCO", the oscillating frequency will periodically change. Generally, it is used to create a VIBRATO effect.

When set to "VCF", it will cause the tone to vary periodically. This is used in general to create a GROWL, or WAH-WAH effect. When set to "VCA", it will cause the volume to vary periodically. It is general used to create a TREMOLO effect.

Change this switch over and confirm the condition in which the sound changes.

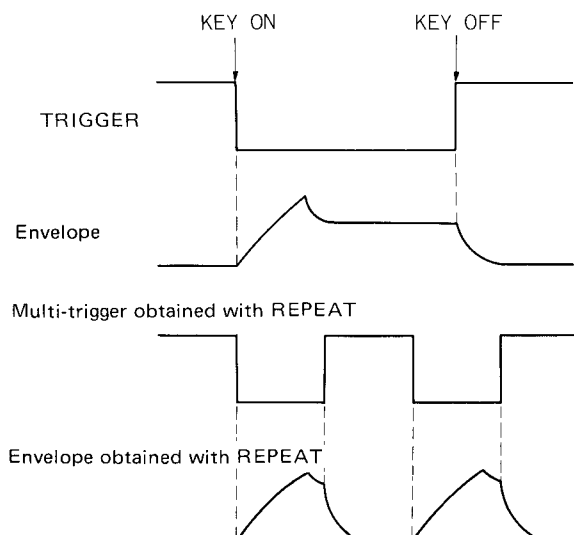

At the same time, it is possible to modulate the VCO, VCF and VCA blocks with the S/H form using the MODULATION SWITCH ⑨ and MODULATION WHEEL ⑧.

- In the case of sounds which are slow to start up, the volume may become markedly small, or no sound at all may be heard when the SPEED control is set at too fast a speed. This is due to the reason that the sound fails to start up fully during the REPEAT period.

**NOTE: Principle of S/H**

In reference to S/H, modulation is performed by an electrical circuit (Sampling and Hold) that reads (samples) the value of the noise wave form at a certain moment, and then holds this value until the next value is sampled.

**Basic principle of S/H**

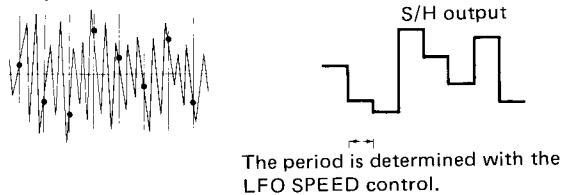

**⑪ SPEED**

This is a control that determines the speed at which modulation is to be changed.

By changing the speed, the way in which the modulation effect appears will differ considerably.

Now, the functions of SUSTAIN, PORTAMENTO and BRILLIANCE will be described. These controls are unrelated to the other controls, each having independent functions.

**⑫ SUSTAIN**

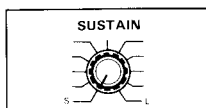

This control is used to control resonance during the period from KEY-OFF to the point the sound fades away. The preset tones of the VOICE SELECTOR contain resonance that has been preset. It can be freely controlled, however, to meet ones taste, and according to the details of the number that is being performed. When the control is positioned to "S", resonance of a length equal either to the preset tone or to the length set manually can be created. The control should be normally set to "S" when creating manual voices.

**⑬ PORTAMENTO**

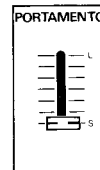

PORTAMENTO denotes that effect in which the pitch, starting from the previously played key, undergoes a smooth variation until it reaches the pitch of the next key to be played. Confirm this by sliding the lever toward the L-side. Normally, it is positioned to the S-side.

**⑭ BRILLIANCE**

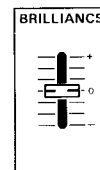

This lever is used for controlling the tone. It works upon the VCF, making the sound more brilliant and harder the more the lever is moved toward the "+" side, and softer, the more the lever is moved toward the "-" side.

It is a convenient lever that can be used to alter the preset tones to such that meets ones taste, and to change the real-time tone so as to match it with the movement and rhythm of the number that is being played.

- When this lever is moved to the end of the "-" side, the volume may drop markedly depending on the preset tone, or sounds may cease to come out. This is because the VCF has cut off even the fundamental tone. In this case, the lever, if lowered while playing the keyboard, can be used as a fader.



# OPERATIONS/VOICE SELECTOR

This block is used for selecting the preset voices, or the manual voices.

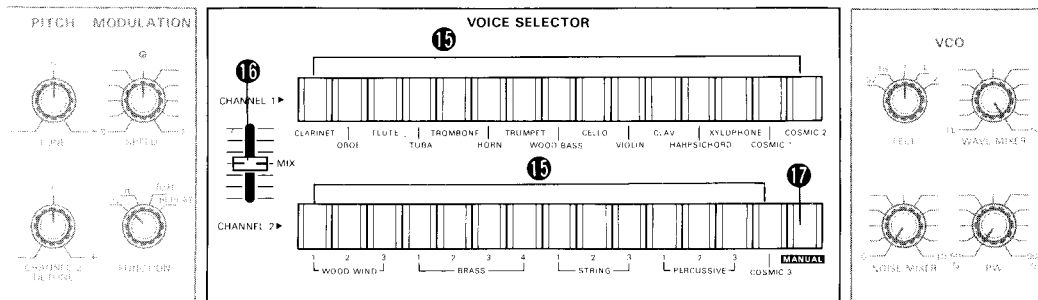

## 15 VOICE SELECTOR buttons

When no button has been depressed, the tone at the left end will be selected. In the condition where 2 or more buttons have been simultaneously depressed, priority will be given to the voice at the right end and that voice will be selected.

## 16 MIX (Mixing lever)

This lever is used for selecting either Ch-1 or Ch-2, or for balancing the volumes of the two channels.

## 17 MANUAL SELECTOR

When the MANUAL button of Ch-2 is depressed, it permits voices created at the MANUAL block to be selected.

## MANUAL BLOCK/CREATES VOICES.

The 29 preset tones, too, have as a rule been created in the same manner as voices created at the MANUAL block, that is, by setting the controls of the MANUAL block. At the MANUAL block, various voices, including those being preset, can be freely created by controlling the MANUAL block controls.

Largely divided, the MANUAL block can be grouped into three blocks: the VCO, VCF and VCA blocks. These blocks correspond respectively to the three factors characterizing sounds, that is, pitch, tone and volume. The blocks are prefixed with "VC" to indicate that the factors are voltage-controlled.

The VCO block, consisting of sawtooth waves (  $\nearrow$  ) and square waves (  $\square$  ), is a block that functions to oscillate sound sources that have a large number of harmonics and noise corresponding to the pitch of the key. The VCF is a block capable of freely changing the portion of the harmonics to be removed and that to be left (known as the cut-off frequency). Meanwhile, the VCA block has the functions of giving a transient change to the volume from the point the voice starts up to the point it fades away.

The following describes the functions of the controls for each block. Set the CS15D in the manner shown in the following drawing so that sounds will be produced the moment the keys are depressed.

Other controls should be set to the positions shown on Page 5, so that effects such as modulation will not be created.

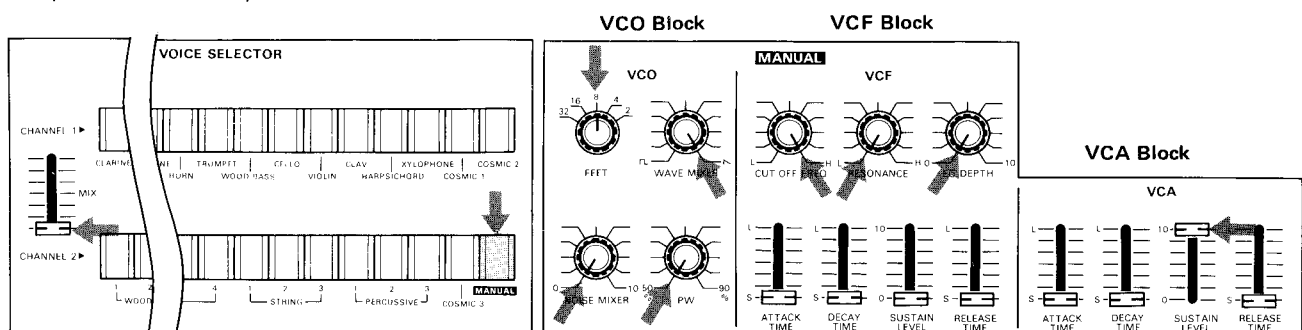

# CREATING SOUNDS/VCO...To Create Sound Sources

The VCO is the abbreviation for the Voltage Controlled Oscillator. By using the CONTROL VOLTAGES (KEY VOLTAGE) that correspond to the pitches of the keyboard, the block oscillates sound source signals that have a large number of harmonics.

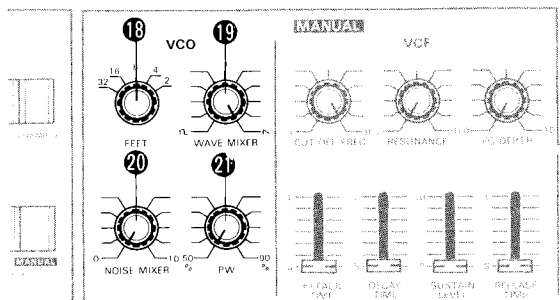

On the other hand, the sawtooth waves (  $\sphericalangle$  ) consist of the fundamental tone and a fixed rate of harmonics of an even-number-folds of the fundamental tone. Its harmonics structure resembles that of general musical instruments such as string instruments. Compared with the square wave (  $\square$  ), it has a relatively large number of harmonics, and the tone is hard.

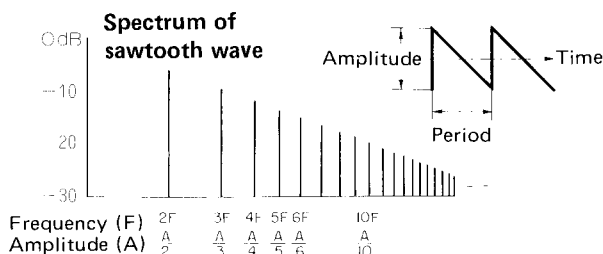

## 18 FEET

This switch functions to change over the sound range of the keyboard. The CS15D covers 3 octaves with its 37 keys. However, by using the FEET switch, which enables the sound range to be changed in octaves, the total sound range can be enlarged to cover 7 octaves.

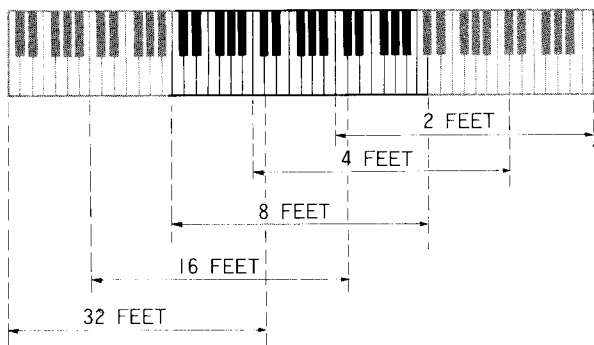

Confirm this by changing over the switch.

## 19 WAVE MIXER

This control functions to mix square waves (  $\square$  ) with sawtooth waves (  $\sphericalangle$  ).

The square waves (Duty ratio: 50%) consist of the fundamental tone and a fixed rate of harmonics of an odd-number-folds of the fundamental tone. This harmonics structure resembles that of closed brass instruments such as the clarinet.

### Spectrum of symmetrical square wave

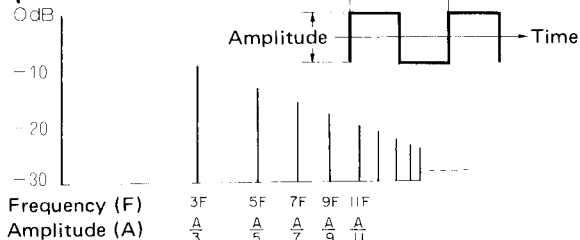

## 20 PW (Pulse width)

This control is used for controlling the pulse width of the square wave (  $\square$  ). When positioned to "50%", the pulse width will be equal for the upper and lower sides, while the more it is turned toward the "90%" side, the broader the pulse width will be for the upper side. The more the pulse width is broadened, the richer the harmonics will become, creating a nasal tone. For the FAGOTTO tone and cosmic voices, square waves (  $\square$  ) with broadened pulse width are used.

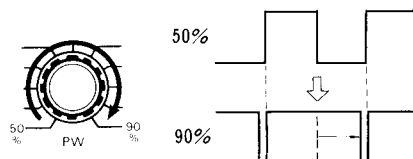

## 21 NOISE MIXER

Noise is characterized by the fact that it has no fundamental tone (and therefore, no pitch) and is rich in frequency components over the frequency range from low to high. As the control is turned clockwise, the amount of mixed-in noise will increase. When the control is turned as far as "10", noise alone will be fed out.

Noise is applied as a "breath" sound for wind instruments, or as the sound source for such effects as of a train and fireworks.

This covers the description of the VCO. Now, to confirm the functions of the controls of the VCF block, set the WAVE selector to "  $\sphericalangle$  ", NOISE MIXER to "0" and FEET to "4". With this, let us proceed to the next section.

# CREATING SOUNDS/VCF...To Create Tones

The VCF block is a voltage controlled filter that functions to create different tones by cutting off a part of the harmonics of the sound source signals sent from the VCO, or to emphasize a part of the harmonics by controlling the Resonance frequency.

## 22 CUT OFF FREQ (Cut-off frequency)

This control is used to control the filter's cut-off frequency.

Since the filter used for the CS15D is an LPF (low-pass filter), harmonic components that are lower than the cut-off frequency are permitted to pass through, but those higher will be cut off.

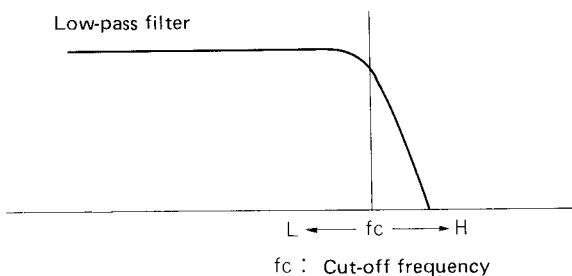

In this case, the CUT OFF FREQ control is positioned to "H" so that practically all of the harmonics sent from the VCO will be permitted to pass through. While playing the keyboard, gradually turn this control toward the "L" direction. You will notice that the tone becomes gradually softer. And when turned further toward the "L" side, eventually no sound will be produced. This is because even the fundamental tone has been cut off by the filter.

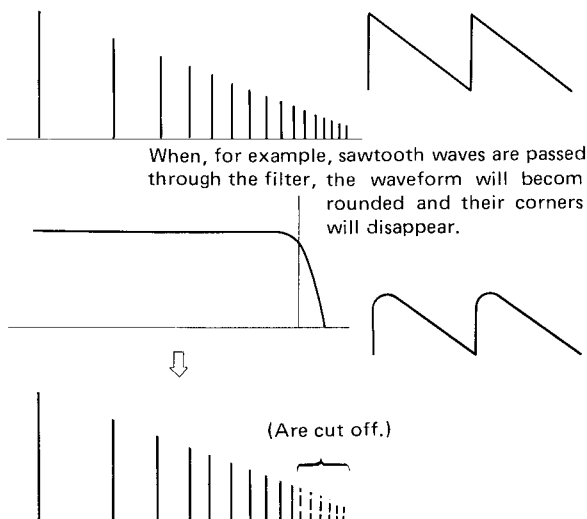

With the control positioned to about "4" (one graduation closer to the "L" side with regard to the center), please proceed to the next section.

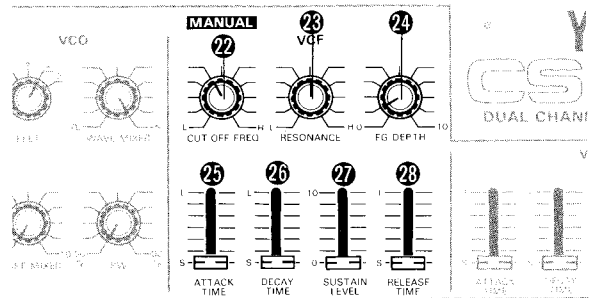

## 23 RESONANCE

This control functions to emphasize only those harmonics in the vicinity of the cut-off frequency.

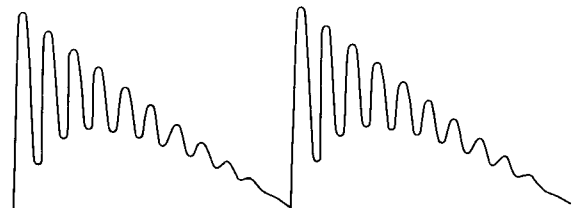
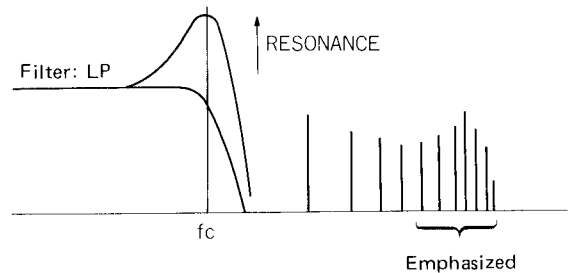

The waveform will become jagged and the tone bright.

Here, this control is positioned to the "L" side. While playing the keyboard, gradually turn this control toward the "H" direction. You will notice that the tone has changed. It has become a little brighter, but of a brightness that is different from that when the CUT OFF FREQ control was turned fully toward "H".

Now set this control roughly to the center. You will notice that this tone is roughly the same as that of FLUTE preset into Ch-1. Shift the MIX lever to the "1" side and confirm this.

# CREATING SOUNDS/VCF-EG...To Give the Tone a Temporal Variation

The way in which the sound of a musical instrument rises and falls during the period from the point it starts up to the point it disappears is not uniform but delicately changes in terms of pitch, tone and volume. The envelope generator plays the role of creating this variation.

In the CS15D, this variation is divided into 4 modes. An envelope, that is, the variation curve is produced by controlling these 4 modes by means of a lever.

- The envelope generator is controlled by the trigger, which is a signal indicating that a key is being depressed.

## 24 EG DEPTH

This control operates in an inter-related manner to the 4 levers provided on the lower side and the envelope generator.

It controls the intensity with which the envelope set at the envelope generator works on the VCF. The envelope acts on the VCF's cut off frequency to give a transient variation to the tone.

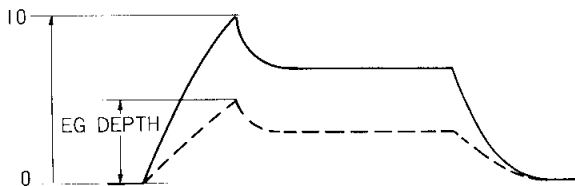

Now, with this control set tentatively at about the middle (12 o'clock), proceed to the next item.

## 25 ATTACK TIME (Starting time)

This lever controls the time starting from when the sound starts at KEY-ON, up to the point at which the tone undergoes maximum variation.

## 26 DECAY TIME (Fall time)

This lever controls the time starting from maximum variation to the time the tone settles down to a stable level controlled by "SUSTAIN".

## 27 SUSTAIN LEVEL

This lever is used for controlling the tone during the period the sound is sustained stably when the keyboard is being played, following completion of ATTACK and DECAY variations.

## 28 RELEASE TIME

This lever controls the duration of tone variation from the point the key is released to the point the sound fades away.

Confirm the effects just described by sliding the 4 levers in various manners.

### Envelope of VCF-EG

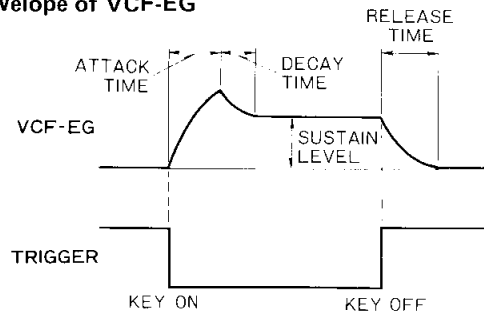

Now, let us produce an envelope resembling that of FLUTE. As the degree of maximum variation is too large, reset the EG DEPTH to the position around 9 o'clock. The FLUTE envelope is characterized by a relatively longer ATTACK and by the fact that there is little difference between the maximum variation level and SUSTAIN LEVEL. You should be able to obtain an envelope similar to that of FLUTE at the setting shown below. However, the effect of RELEASE TIME is still unclear.

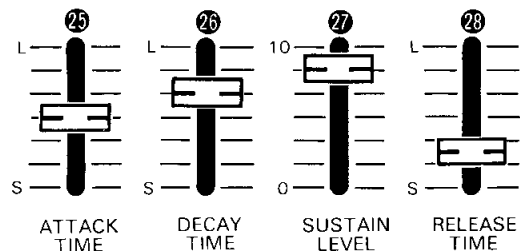

### NOTE: When EG acts upon VCF

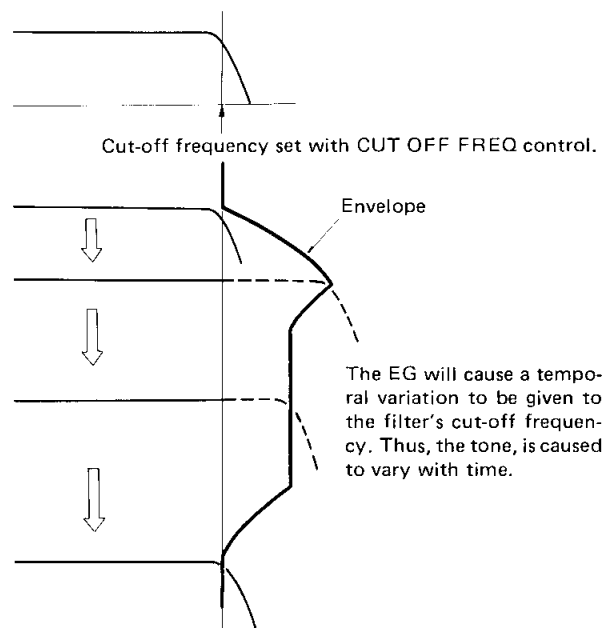

# CREATING SOUNDS/VCA...To Give the Volume an Envelope

The VCA, which is a voltage controlled amplifier, is a block that functions to change, by means of the envelope generator, the volume of a sound from the point the sound starts at KEY-ON to the point it fades away leaving a resonance.

As with the case of the VCF, the envelope produces a change in the volume with the variation divided into 4 modes, ATTACK, DECAY, SUSTAIN and RELEASE.

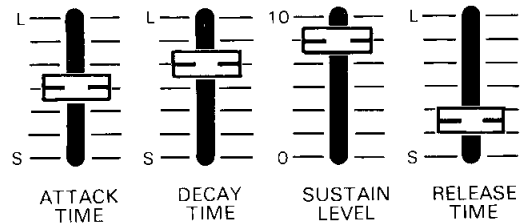
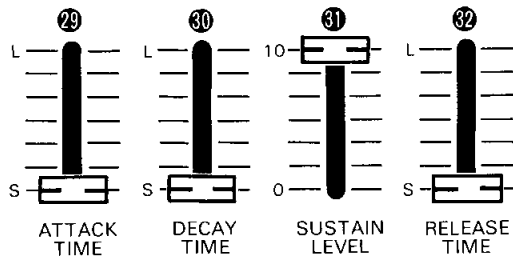

## 29 ATTACK TIME

This lever controls the time from the point the sounds starts at KEY-ON up to the point it reaches the maximum volume level.

## 30 DECAY TIME

This lever controls the time from the point of maximum volume to the point the volume reaches that of SUSTAIN level.

## 31 SUSTAIN LEVEL

This lever controls the volume of a sound sustained at a stable level while the keyboard is being played following completion of the sounds's ATTACK and DECAY variations.

## 32 RELEASE TIME

This lever controls the length of resonance from KEY-OFF up to the point at which the sound fades away.

The same setting as used for the VCF, as shown above, should be satisfactory. Finish the tone to suit your taste by further adjusting the VCF, and by applying a slight modulation.

## Variations

### Clarinet

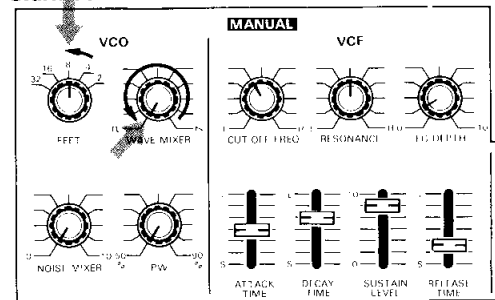

Sounds resembling those of a clarinet can be created by simply turning the FLUTE settings's "FEET" to "8" and "WAVE MIXER" to "1".

### Fagotto

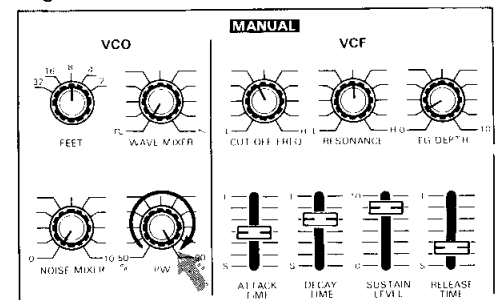

FAGOTTO sounds are obtained by turning "PW" to "90%" from the CLARINET setting.

As the above settings are merely basic settings, you should give the sounds a finish that suits your taste through fine-adjustments of the VCF and VCA performed while listening to the sounds.

## Envelope of VCA-EG

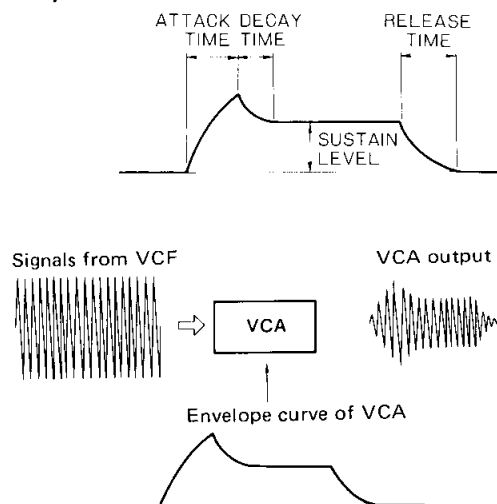

# FOR FULL UTILIZATION/Operation...Summary

- **Make use of the preset voices.**

The preset voices cover a large number of the sounds of general musical instruments. Accordingly, the key to making the best use of the CS15D is to use the preset voices in a clever manner.

One way to make the best use of the preset voices is to apply modulation in a way to match your taste. This will result in rendering increased depth and higher reality to the sounds.

- **Example 1: Application of VIBRATO to sounds of string and brass instruments**

Application of a slight VIBRATO to such sounds as CLARINET, FLUTE, TROMBONE, TRUMPET, CELLO and VIOLIN will give the sounds a higher reality. This is achieved by setting MODULATION FUNCTION to “~”, MODULATION SPEED to “6 (One scale more toward the “F” side from the center)” and the MODULATION switch to “VCO”, and then controlling the MODULATION wheel to match the music being played.

- **Example 2: Application of TREMOLO to XYLOPHONE**

For XYLOPHONE, multi-trigger performance is possible by setting FUNCTION to “REPEAT” and SPEED to “6.5 (One and a half scale further toward the “F” side from the center)”.

- **Example 3: Application of WAH-WAH to COSMIC sounds**

To create unique sounds by giving the COSMIC sounds a WAH-WAH effect, set FUNCTION to “~”, SPEED to “6” and the MODULATION switch to “VCF”, and then apply a somewhat strong modulation by controlling the MODULATION wheel.

In this way, it is possible to change the atmosphere of the preset voices by modulating them.

Another method that enables fuller use of the preset voices is to use the BRILLIANCE lever effectively. The BRILLIANCE lever is normally set to the center position. However, the tone of the preset voices can be changed considerably by controlling BRILLIANCE. In addition to giving a more real finish to the preset voices by the delicate control of tone, this also proves to be effective for deliberately changing the tone to a different one, thus giving an unlimited expression to the 29 preset voices.

- **Render variety and depth to the sounds by mixing them.**

Variety can be given to performances by mixing the dual voices of Ch-1 and Ch-2 and by letting them flow to different lines.

In this case, it is also possible to create such effects as a chorus effect by the use of DETUNE set to UNISON (“0” position), or to produce a string effect, or a harmony effect by shifting the pitches of the two voices apart by the third, or fifth.

- **You can create any sound freely by manual operation (Summary of procedures)**

1. Select the sound source.

First determine the wave form to be used as the sound source. Then, determine the sound range of the desired sound by means of FEET.

2. Rough sound creating

Now, using the VCF, roughly produce the desired tone. Compose the fundamental tone by using the CUT OFF FREQ control.

3. Apply a transient variation.

Apply an envelope to the tone and volume. Key that opens the way to higher-reality sounds lies in this envelope application.

4. Finishing the sound

Finely adjust the sound source; cut off frequency, resonance, envelope, etc. to bring the sound to the desired one.

5. Give the sounds certain nuances with EFFECT.

To give the sounds a final finish, apply modulation, etc.

- **Example 4: MANUAL COSMIC VOICE**

An assortment of three COSMIC voices are provided as preset voices. In this example, however, we have created one that differs from the three that have been preset. Here, the VCA's SUSTAIN lever is raised to the highest position and the sounds are controlled by the VCF's envelope from the point of start-up to fade-away. In other words, the cut-off frequency during KEY-OFF is set to a level below the fundamental tone. But at KEY-ON, because of the VCF's EG, it is raised to levels above the fundamental tone, causing COSMIC sounds of a particular effect to be created.

**Example 4: Manual cosmic voice**

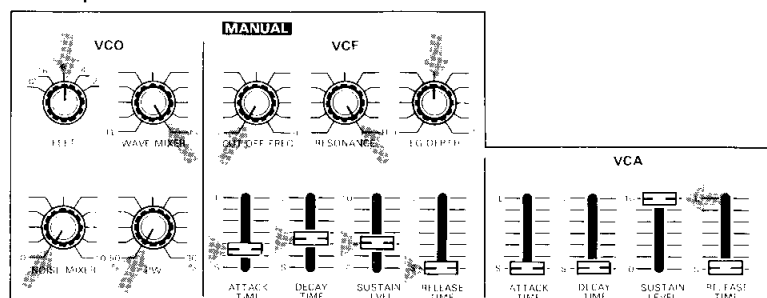

# FOR FULL UTILIZATION/Using Two Synthesizers

Being provided with input/output terminals for the voltage signals (CONTROL VOLTAGE) that correspond to the pitches of the keyboard, and signals indicating that a key is being depressed (TRIGGER), the CS15D is capable of feeding out such data to another synthesizer \* having similar terminals, or of receiving data from another synthesizer. As a result, it can control the VCO → VCF → VCA of a multiplex system through a single keyboard.

\* CS-10, CS-30, CS-30L (TRIGGER, KEY VOLTAGE)  
CS-5, CS-15, CS-30 sequencer output (TRIGGER, CONTROL VOLTAGE)

- CONTROL VOLTAGE AND TRIGGER can be fed in and out independently.

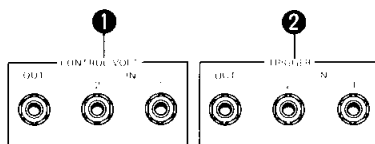

## 1 CONTROL VOLTAGE

These terminals are used for feeding in, or out, the CONTROL VOLTAGE that indicates the pitches of the keyboard to, or from the CONTROL VOLTAGE terminal, or KEY VOLTAGE terminal of another synthesizer.

### OUT

This is a terminal used for feeding out the CONTROL VOLTAGE to another synthesizer.

This voltage has been controlled by the PORTAMENTO lever and PITCH bend wheel. However, it does not contain such information as does TUNE, DETUNE, or FEET.

### IN 1/2

This is a terminal through which the CONTROL VOLTAGE, or KEY VOLTAGE of another synthesizer is fed in to Ch-1, or Ch-2.

## 2 TRIGGER

By being connected with the TRIGGER terminal of another synthesizer, these terminals permit TRIGGER signals to be fed in, or out. The TRIGGER signal has the function to start-up the envelope generator.

### OUT

A terminal used for feeding out TRIGGER to another synthesizer.

- When REPEAT is selected by means of the FUNCTION switch of MODULATION, this terminal will feed out multi-TRIGGER signals at the speed set by the SPEED control.

### IN 1/2

These terminals are used to feed in the TRIGGER of another synthesizer unit for use as a TRIGGER to control the EG of either Ch-1, or Ch-2.

- Special attention should be paid in connecting the terminals, for troubles will be caused should the CONTROL VOLTAGE terminal be connected to the TRIGGER terminal by mistake.

- The following drawing shows a typical example of the application of the CONTROL VOLTAGE and TRIGGER of Synthesizer 1 (CS15D) to Ch-1 of Synthesizer 2. This arrangement enables simultaneous control of a total of 3 channels, that is, Chs. 1 & 2 of Synthesizer 1 and Ch-1 of Synthesizer 2 through the keyboard of Synthesizer 1. Furthermore, the Ch-2-side of Synthesizer 2 can be operated in the normal way through the keyboard of Synthesizer 2.

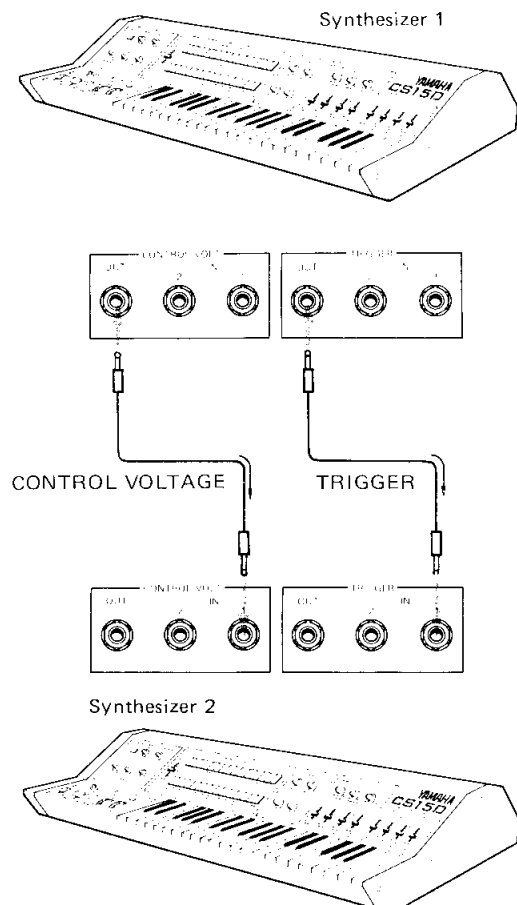

The CH-2 of synthesizer 2 can be operated in the normal way through the keyboard of synthesizer 2.

# CS15D SOUND MEMO

DATE: / /

SOUND NAME

**YAMAHA CS15D DUAL CHANNEL SYNTHESIZER**

**OUTPUT PITCH MODULATION**

**VOICE SELECTOR**

**VCO**

**VCF**

**VCA**

NOTE :

DATE: / /

SOUND NAME

**YAMAHA CS15D DUAL CHANNEL SYNTHESIZER**

**OUTPUT PITCH MODULATION**

**VOICE SELECTOR**

**VCO**

**VCF**

**VCA**

NOTE :



# BLOCK DIAGRAM/SPECIFICATIONS

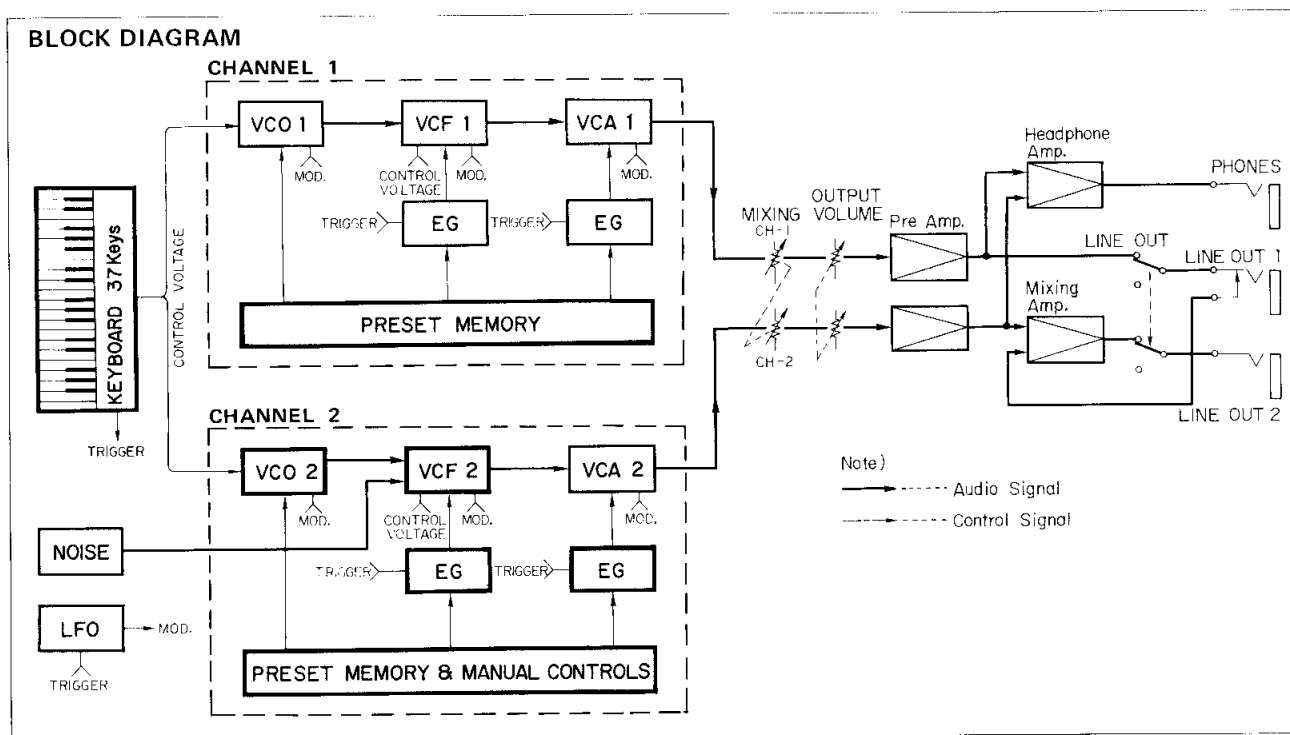

## SPECIFICATIONS

**KEYBOARD** . . . . . 37 keys, c2 through c5 (3 octaves)

### CONTROLS

**PITCH** . . . . . TUNE: -75 to +75 cents  
 CHANNEL 2 DETUNE:  
 -750 to +850 cents

### MODULATION (LFO):

SPEED: 0.1 to 100Hz  
 FUNCTION:  $\sim$ ,  $\square$ , S/H, REPEAT

**SUSTAIN** . . . . . S to L (6.5  $\pm$  2 sec.)

**PORTAMENTO** . . . S to L (3.5 sec. max.)

**BRILLIANCE**

**PITCH WHEEL** . . . OCTAVE UP/DOWN ( $\pm$ 1200 cents)

**MODULATION WHEEL:**

VCO/VCF/VCA

**OUTPUT** . . . . . LINE OUT ON/OFF

VOLUME

### VOICE SELECTOR (Preset voice)

**MIX** . . . . . CHANNEL 1, CHANNEL 2: Balance

**CHANNEL 1** . . . . . CLARINET / OBOE / FLUTE / TUBA

TROMBONE / HORN / TRUMPET

WOOD BASS / CELLO / VIOLIN / CLAV

HARPSICHORD / XYLOPHONE

COSMIC 1 / COSMIC 2

**CHANNEL 2** . . . . . WOOD WIND 1,2,3 / BRASS 1,2,3,4

STRING 1,2,3 / PERCUSSIVE 1,2,3

COSMIC 3 / MANUAL

### MANUAL

**VCO** . . . . . FEET: 32' / 16' / 8' / 4' / 2'

WAVE MIXER:  $\square$  to  $\triangle$

NOISE MIXER

PW: 50% to 90%

**VCF** . . . . . CUT OFF FREQ

RESONANCE: Q= 0.5 to 10

EG DEPTH

ATTACK TIME: 0.001 to 1 sec.

DECAY TIME: 0.01 to 10 sec.

SUSTAIN LEVEL

RELEASE TIME: 0.01 to 10 sec.

**VCA** . . . . . ATTACK TIME: 0.001 to 1 sec.  
 DECAY TIME: 0.01 to 10 sec.  
 SUSTAIN LEVEL  
 RELEASE TIME: 0.01 to 10 sec.

### JACKS

**LINE OUT** . . . . . 1, 2/MIX (-9.5dBm)

**CONTROL VOLT** .IN 1/2 (0.125 to 4V)

OUT (0.125 to 4V)

**TRIGGER** . . . . . IN 1/2 (OFF: +15 to +3V)

(ON: 0 to -15V)

OUT (OFF: +3V, ON: -7V)

**PHONES** . . . . . 8 ohms

### OTHERS

**POWER SOURCE** . U.S and CANADIAN models:

120V, 60Hz

GENERAL model: 110 to 130V or

220 to 240V selectable, 50/60Hz

**POWER CONSUMPTION:** 25 Watts

**DIMENSIONS** . . . .854 x 134.3 x 346mm

(W x H x D) (33-5/8 x 5-1/4 x 13-5/8")

**WEIGHT** . . . . . 12kg (26.5 lbs.)

**FINISH** . . . . . Semi-gloss black panels, rosewood-grain cabinet

Specifications subject to change without notice.

# TROUBLESHOOTING

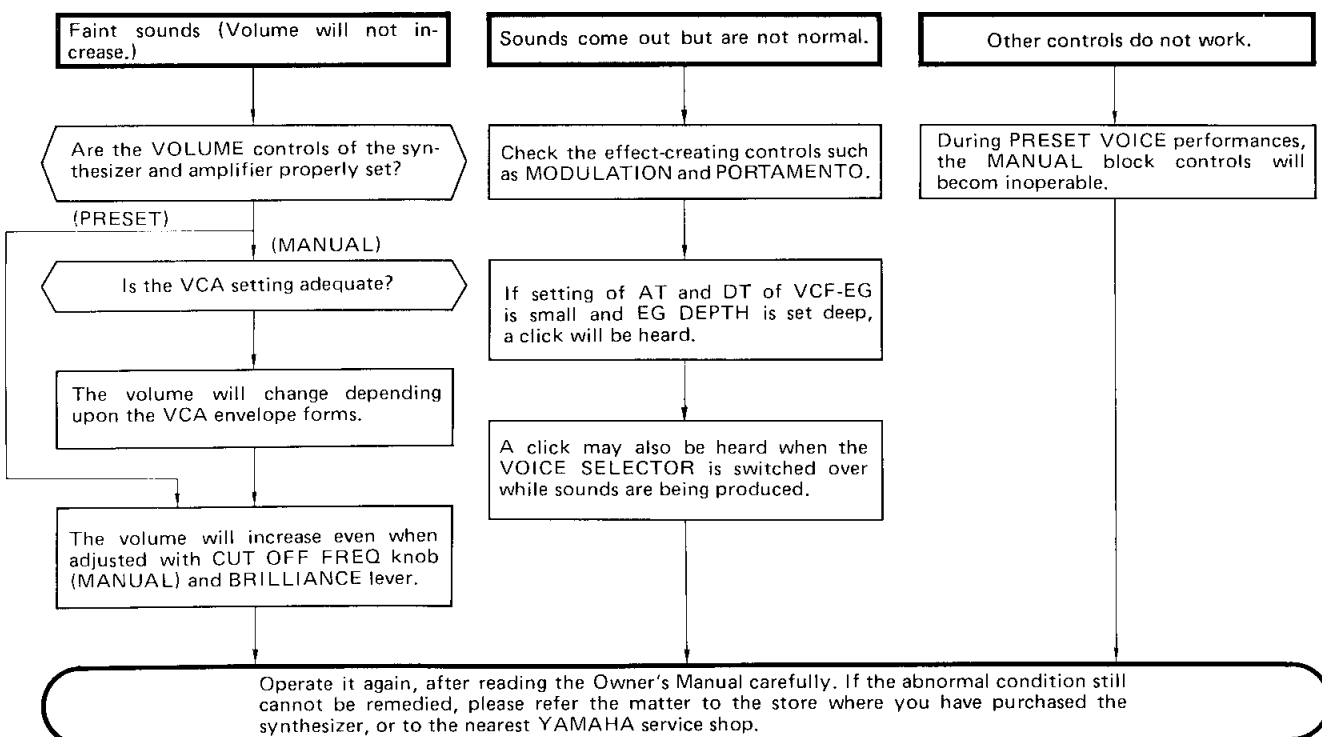
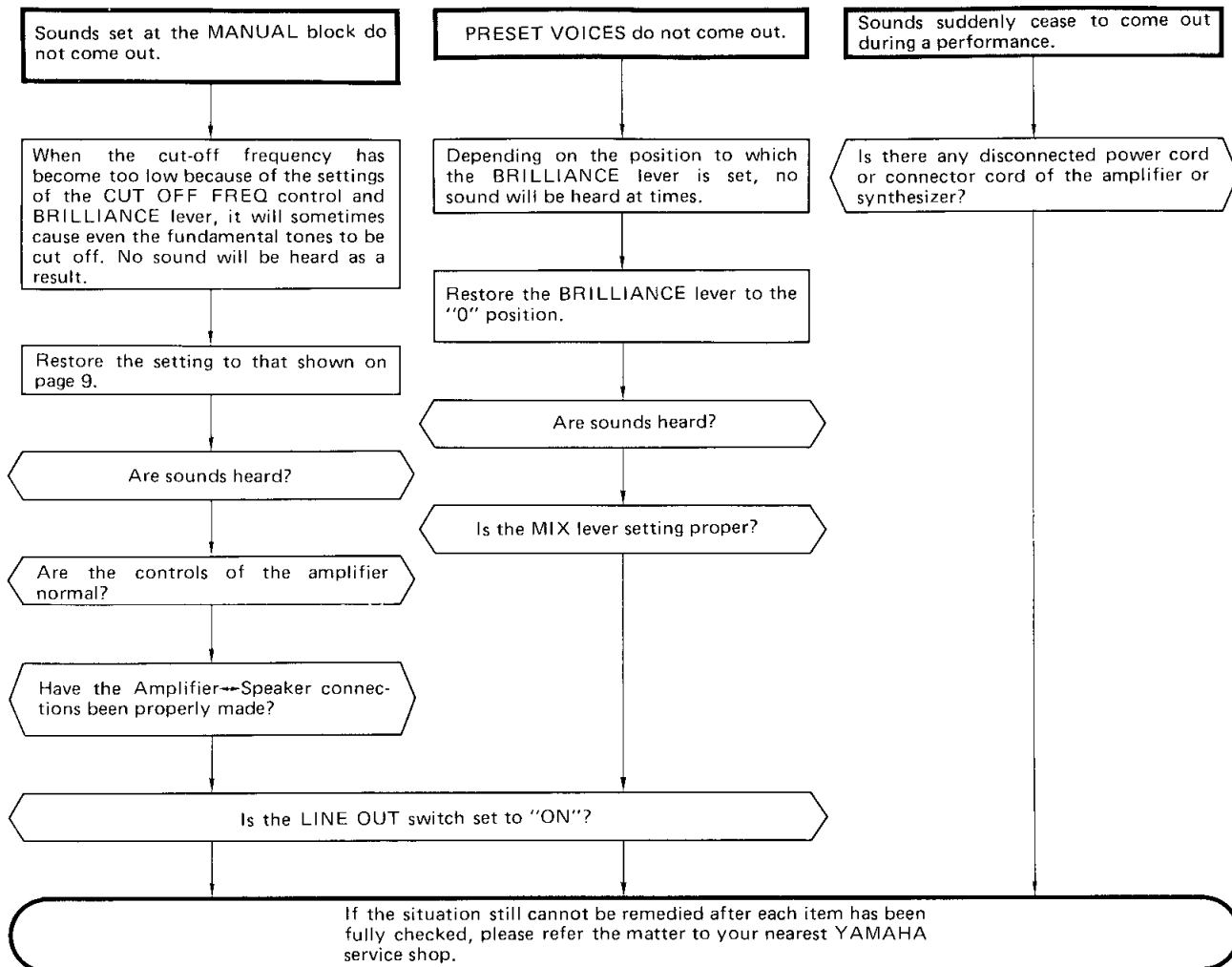

SINCE 1887  **YAMAHA**  
NIPPON GAKKI CO., LTD. HAMAMATSU, JAPAN

## Free Manuals Download Website

<http://myh66.com>

<http://usermanuals.us>

<http://www.somanuals.com>

<http://www.4manuals.cc>

<http://www.manual-lib.com>

<http://www.404manual.com>

<http://www.luxmanual.com>

<http://aubethermostatmanual.com>

Golf course search by state

<http://golfingnear.com>

Email search by domain

<http://emailbydomain.com>

Auto manuals search

<http://auto.somanuals.com>

TV manuals search

<http://tv.somanuals.com>