



2009 WaveRunner FX SHO FX Cruiser SHO

OWNER'S/OPERATOR'S MANUAL

 **Read this manual carefully
before operating this watercraft.**

U.S.A. Edition
YAMAHA MOTOR CORPORATION, U.S.A.
LIT-18626-08-16
F1W-F8199-11

WARNING

The engine exhaust from this product contains chemicals known to the State of California to cause cancer, birth defects or other reproductive harm.

YAMAHA

LIT-CALIF-65-01

Read this manual carefully before operating this watercraft. This manual should stay with the WaveRunner if it is sold.

Important manual information

EJU30181

To the owner/operator

Thank you for choosing a Yamaha watercraft. This owner's/operator's manual contains information you will need for proper operation, maintenance, and care. A thorough understanding of these simple instructions will help you to obtain maximum enjoyment from your new Yamaha. If you have any questions about the operation or maintenance of your watercraft, please consult a Yamaha dealer. Because Yamaha has a policy of continuing product improvement, this product may not be exactly as described in this owner's/operator's manual. Specifications are subject to change without notice.

This manual should be considered a permanent part of this watercraft and should remain with it even if the watercraft is subsequently sold.

In this manual, information of particular importance is distinguished in the following ways:



The Safety Alert Symbol means ATTENTION! BECOME ALERT! YOUR SAFETY IS INVOLVED!

EWJ00071



WARNING

A WARNING indicates a hazardous situation which, if not avoided, could result in death or serious injury.

ECJ00091

NOTICE

A NOTICE indicates special precautions that must be taken to avoid damage to the watercraft or other property.

TIP:

A TIP provides key information to make procedures easier or clearer.

EJU30221

**WaveRunner FX SHO/FX Cruiser SHO
OWNER'S/OPERATOR'S MANUAL
©2008 by Yamaha Motor Corporation,
U.S.A.**

1st Edition, May 2008

All rights reserved.

**Any reprinting or unauthorized use
without the written permission of
Yamaha Motor Corporation, U.S.A.
is expressly prohibited.**

Printed in U.S.A.

P/N LIT-18626-08-16

Table of contents

General and important labels	1	Cooling water pilot outlets	34
Identification numbers	1	Steering system	35
Primary Identification (PRI-ID)		Tilt lever	35
number	1	Shift lever	36
Hull Identification Number (HIN)	1	Quick Shift Trim System (QSTS)	
Engine serial number	1	selector	36
Emission control information	2	Handgrip	38
Approval label of emission control		Reboarding step	38
certificate	2	Bow eye	38
Manufactured date label	3	Stern eyes	39
Star labels	3	Pull-up cleats	
Important labels	5	(for FX Cruiser SHO)	39
Warning labels	6	Yamaha Engine Management	
Other labels	8	System (YEMS)	39
Safety information	10	Yamaha Security System	39
Limitations on who may operate		No-wake mode	41
the watercraft	10	Cruise assist	42
Cruising limitations	11	Multifunction information center	44
Operation requirements	13	Storage compartments	54
Recommended equipment	15	Operation	57
Hazard information	16	Fuel and oil	57
Watercraft characteristics	16	Fuel	57
Water-skiing	18	Engine oil	58
Rules of the Road	20	Pre-operation checks	59
To get more boating safety		Pre-operation check list	59
information	24	Pre-operation check points	61
Enjoy your watercraft		Operation	69
responsibly	25	Engine break-in	69
Features and functions	26	Launching the watercraft	69
Location of main components	26	Starting the engine	69
Operation of controls and other		Stopping the engine	70
functions	30	Shifting	71
Seats	30	Leaving the watercraft	71
Hood	31	Operating your watercraft	72
Fuel tank filler cap	31	Getting to know your watercraft	72
Remote control transmitter	31	Learning to operate your	
Engine stop switch	33	watercraft	72
Engine shut-off switch	33	Riding with passengers	73
Start switch	33	Starting the watercraft	73
Right handlebar switches	34	Boarding and starting in deep	
Throttle lever	34	water	74
		Capsized watercraft	77
		Turning the watercraft	78

Table of contents

Stopping the watercraft	79	Submerged watercraft	104
Beaching the watercraft	80	Consumer information	105
Docking the watercraft	80	Limited warranty	105
Reverse on waterways	80	YAMAHA EXTENDED SERVICE	
Operating in weeded areas	81	(Y.E.S.)	107
Post-operation care	81		
Transporting	82		
Maintenance and care.....	83		
Storage	83		
Flushing the cooling system	83		
Lubrication	84		
Battery	84		
Cleaning the watercraft	84		
Maintenance and adjustments	85		
Owner's/operator's manual and			
tool kit	85		
Periodic maintenance chart	87		
Checking the fuel system	89		
Engine oil and oil filter	89		
Air filter element	89		
Checking the jet thrust nozzle			
angle	89		
Checking the shift cable	90		
Checking and adjusting the throttle			
cable	90		
Cleaning and adjusting the spark			
plugs	92		
Lubrication points	93		
Checking the battery	95		
Fuel injection system	96		
Specifications	97		
Specifications	97		
Trouble recovery	98		
Troubleshooting	98		
Troubleshooting chart	98		
Emergency procedures	101		
Cleaning the jet intake and			
impeller	101		
Jumping the battery	102		
Replacing the fuses	102		
Towing the watercraft	104		

General and important labels

EJU30261

Identification numbers

Record the Primary Identification (PRI-ID) number, Hull Identification Number (HIN), and engine serial number in the spaces provided for assistance when ordering genuine parts from a Yamaha dealer. Also record and keep these ID numbers in a separate place in case your watercraft is stolen.

EJU30281

Primary Identification (PRI-ID) number

The PRI-ID number is stamped on a plate attached inside the engine compartment.

MODEL:

FX1800-H (FX SHO)

FX1800A-H (FX Cruiser SHO)

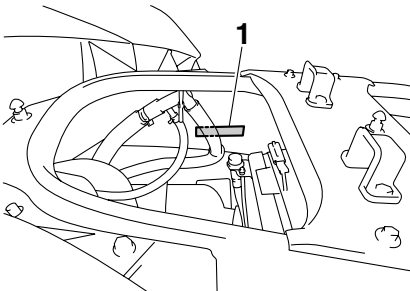

1 Primary Identification (PRI-ID) number location

MODEL	<input type="text"/>	PRI-ID.	<input type="text"/>
YAMAHA MOTOR CO., LTD.		ASSEMBLED IN U.S.A. FROM AMERICAN AND JAPANESE COMPONENTS.	
ASSEMBLÉ AUX ÉTATS-UNIS DE PIÈCES AMÉRICAINES ET JAPONAISES.			

F1W-

EJU30300

Hull Identification Number (HIN)

The HIN is stamped on a plate attached to the aft deck.

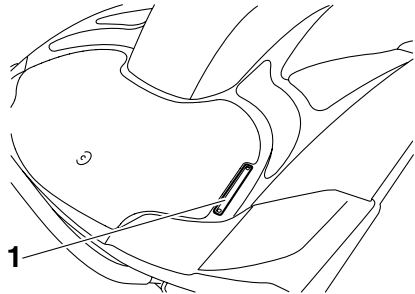

1 Hull Identification Number (HIN) location

US-YAM

EJU30310

Engine serial number

The engine serial number is stamped on a plate attached to the engine unit.

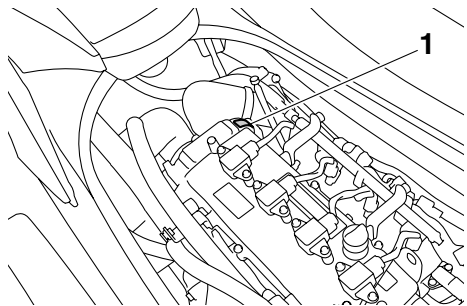

1 Engine serial number location

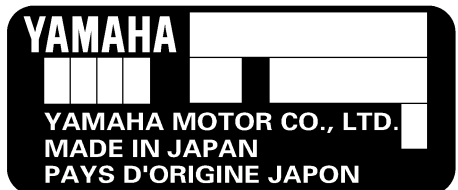

General and important labels

EJU30350

Emission control information

This engine conforms to 2009 U.S. Environmental Protection Agency (EPA) and/or California Air Resources Board (CARB) regulations for marine SI engines.

This engine is certified to operate on regular unleaded gasoline.

EJU30400

Approval label of emission control certificate

This label is attached to the top of the cylinder head and to the inside of the engine compartment.

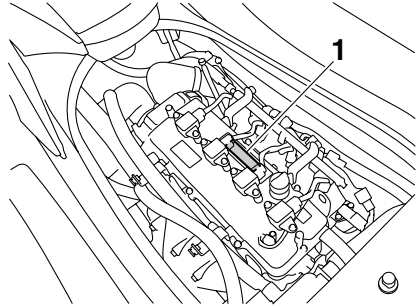

1 Emission control information label location

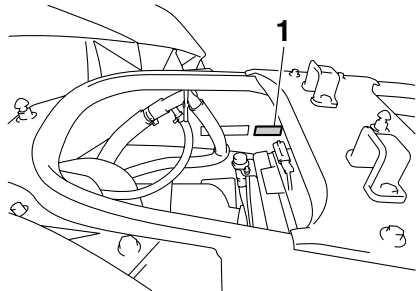

1 Emission control information label location

EMISSION CONTROL INFORMATION		SFI
ENGINE FAMILY : _____		
THIS ENGINE CONFORMS TO _____ CALIFORNIA AND U.S. EPA EMISSION REGULATIONS FOR SI MARINE ENGINES. REFER TO THE OWNER'S MANUAL FOR MAINTENANCE SPECIFICATIONS AND ADJUSTMENTS.		
FUEL : _____	ADVERTISED POWER : _____	FUEL: UNLEADED REGULAR GASOLINE
SPARK PLUG : _____	TROLLING SPEED : _____	VALVE LASH(mm) In: _____ Out: _____
DISPLACEMENT : _____	SPARK PLUG GAP (mm) : _____	
INFORMATION ANTIPOLLUTION		SFI
CATEGORIE DU MOTEUR : _____		
CE MOTEUR EST CONFORME AUX NORMES D'ÉMISSIONS _____ EPA DES É.-U. ET DE LA CALIFORNIE POUR MOTEURS NAUTIQUES SI. POUR CONNAÎTRE LES SPÉCIFICATIONS ET LES RÉGLAGES À EFFECTUER, CONSULTEZ LE MANUEL DU PROPRIÉTAIRE.		
FUEL : _____	PUISSANCE AFFICHÉE : _____	CARBURANT: ESSENCE NORMALE SANS PLOMB
BOUGIE : _____	PALENTI : _____	BOUE SOUPAPE(mm) In: _____ Out: _____
CYLINDRÉE : _____	BOUGIE-ÉCARTEMENT (mm) : _____	
YAMAHA MOTOR CO.,LTD.		

General and important labels

EJU30430

Manufactured date label

This label is attached to the top of the cylinder head.

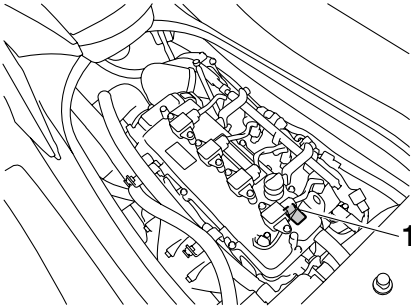

1 Manufactured date label location

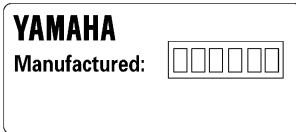

EJU30440

Star labels

This watercraft is labeled with a California Air Resources Board (CARB) star label. See below for a description of your particular label.

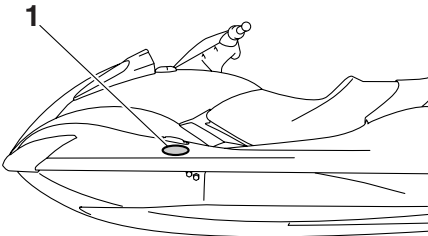

1 Star label location

One Star - Low Emission

The one-star label identifies engines that meet the Air Resources Board's Personal Watercraft and Outboard marine engine 2001 exhaust emission standards. Engines meeting these standards have 75% lower emissions than conventional carbureted two-stroke engines. These engines are equivalent to the U.S. EPA's 2006 standards for marine engines.



Two Stars - Very Low Emission

The two-star label identifies engines that meet the Air Resources Board's Personal Watercraft and Outboard marine engine 2004 exhaust emission standards. Engines meeting these standards have 20% lower emissions than One Star-Low Emission engines.



Three Stars - Ultra Low Emission

The three-star label identifies engines that meet the Air Resources Board's Personal Watercraft and Outboard marine engine 2008

General and important labels

exhaust emission standards or the Sterndrive and Inboard marine engine 2003-2008 exhaust emission standards. Engines meeting these standards have 65% lower emissions than One Star-Low Emission engines.



Four Stars - Super Ultra Low Emission

The four-star label identifies engines that meet the Air Resources Board's Sterndrive and Inboard marine engine 2009 exhaust emission standards. Personal Watercraft and Outboard marine engines may also comply with these standards. Engines meeting these standards have 90% lower emissions than One Star-Low Emission engines.



General and important labels

EJU30451

Important labels

Read the following labels before operating this watercraft. If you need any additional information, contact a Yamaha dealer.

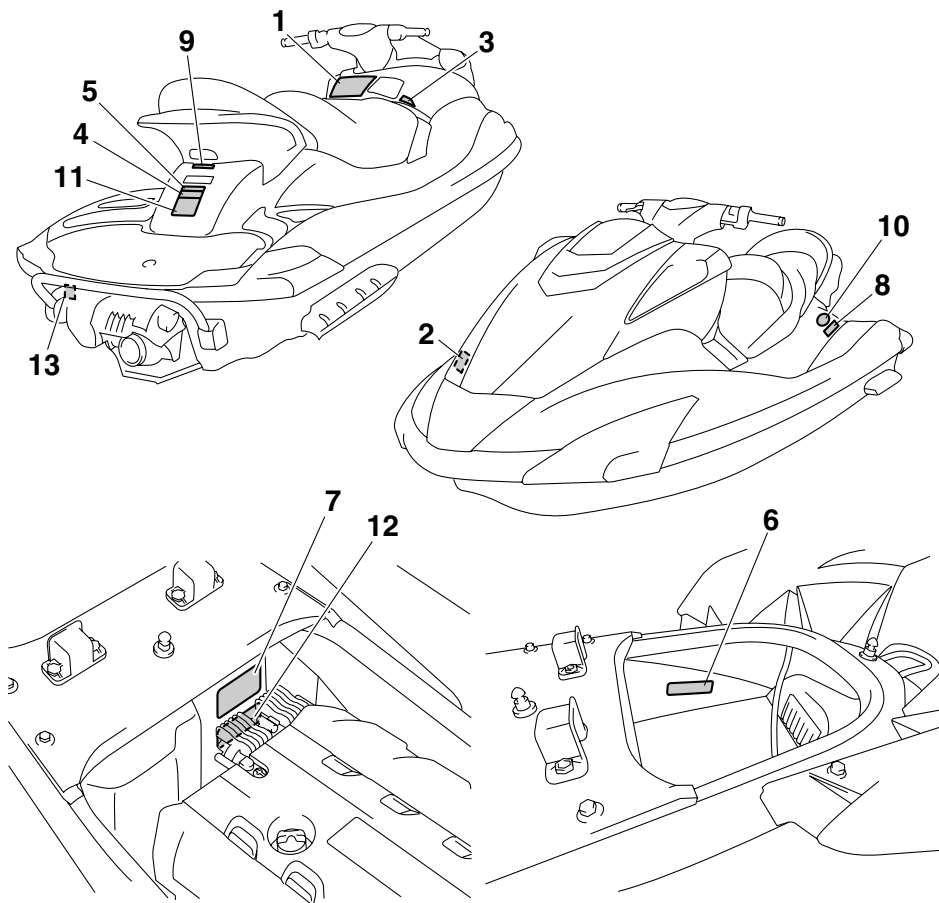

General and important labels

EJU35911

Warning labels

If any of these labels are damaged or missing, contact a Yamaha dealer for replacements.

1

⚠ WARNING

To reduce the risk of SEVERE INJURY or DEATH:

WEAR A PERSONAL FLOTATION DEVICE (PFD).
All riders must wear a Coast Guard approved PFD that is suitable for personal watercraft (PWC) use.

WEAR PROTECTIVE CLOTHING. Severe internal injuries can occur if water is forced into body cavities as a result of falling into water or being near jet thrust nozzle. Normal swimwear does not adequately protect against forceful water entry into rectum or vagina. All riders must wear a wet suit bottom or clothing that provides equivalent protection (See Owner's Manual).

Footwear, gloves, and goggles/glasses are recommended.

KNOW BOATING LAWS. Yamaha Motor Co., Ltd. recommends a minimum operator age of 16 years old. Know the operator age and training requirements for your state. A boating safety course is recommended and may be required in your state.

ATTACH ENGINE SHUT-OFF CORD (LANYARD) to wrist and keep it free from handlebars so that engine stops if operator falls off. After riding, remove cord from PWC to avoid unauthorized use by children or others.

RIDE WITHIN YOUR LIMITS AND AVOID AGGRESSIVE MANEUVERS to reduce the risk of loss of control, ejection, and collision. This is a high performance boat – not a toy. Sharp turns or jumping wakes or waves can increase the risk of back/spinal injury (paralysis), facial injuries, and broken legs, ankles, and other bones.
Do not jump wakes or waves.

DO NOT APPLY THROTTLE WHEN ANYONE IS AT REAR OF PWC—turn engine off or keep engine at idle. Water and/or debris exiting jet thrust nozzle can cause severe injury.

⚠ WARNING

KEEP AWAY FROM INTAKE GRATE while engine is on. Items such as long hair, loose clothing, or PFD straps can become entangled in moving parts resulting in severe injury or drowning.

NEVER RIDE AFTER CONSUMING DRUGS OR ALCOHOL

Collisions result in more INJURIES AND DEATHS than any other type of accident for personal watercraft (PWC).
TO AVOID COLLISIONS:
SCAN CONSTANTLY for people, objects, and other watercraft. Be alert for conditions that limit your visibility or block your vision of others.
OPERATE DEFENSIVELY at safe speeds and keep a safe distance away from people, objects, and other watercraft.

- Do not follow directly behind PWCs or other boats.
- Do not go near others to spray or splash them with water.
- Avoid sharp turns or other maneuvers that make it hard for others to avoid you or understand where you are going.
- Avoid areas with submerged objects or shallow water.

TAKE EARLY ACTION to avoid collisions. Remember, PWCs and other boats do not have brakes.

DO NOT RELEASE THROTTLE WHEN TRYING TO STEER away from objects – you need throttle to steer. Always check throttle and steering controls for proper operation before starting PWC. Follow navigation rules and state/province and local laws that apply to PWCs. See Owner's Manual for more information.



PFD



Wet Suit Bottom

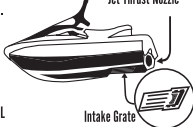

Jet Thrust Nozzle
Intake Grate



READ AND FOLLOW OWNER'S MANUAL
YAMAHA

F1W-U41B1-00

2

⚠ WARNING

Gasoline is highly flammable and explosive. A fire or explosion could cause severe injury or death. Shut engine off. Refuel in well ventilated area away from flames or sparks. Do not smoke. Avoid spilling gasoline. Wipe up spilled gasoline immediately. Remove all seats to ventilate fuel vapors from engine compartment before starting engine. Do not start engine if there is a fuel leak or a loose electrical connection.

REGULAR UNLEADED GASOLINE ONLY

YAMAHA

F1S-U415B-01

General and important labels

3

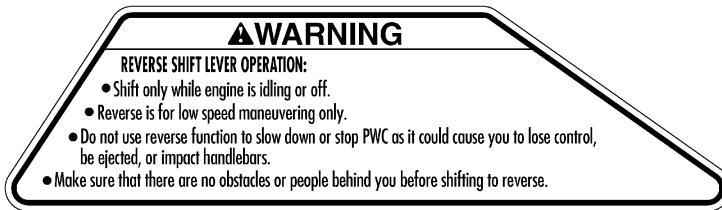

4



5

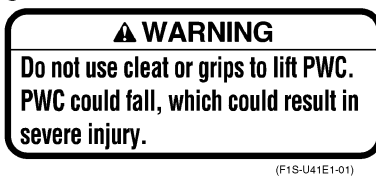

6

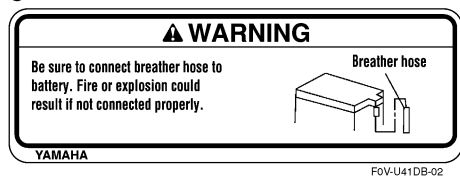

7

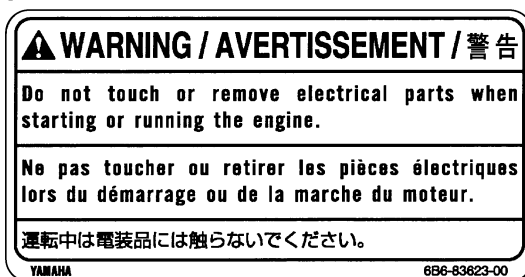

General and important labels

EJU35923

Other labels

8

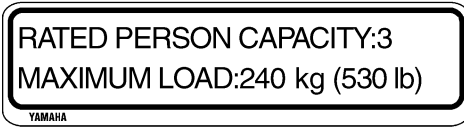

9



10

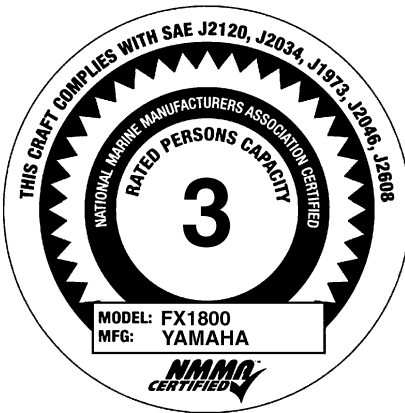

11

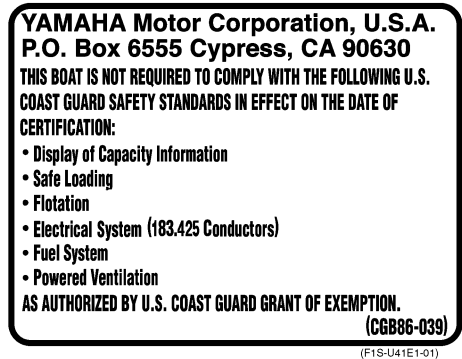

12

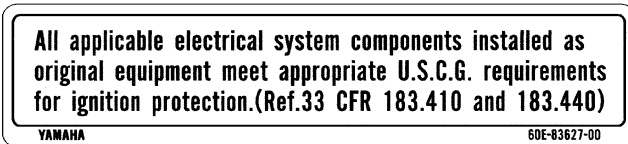

General and important labels

The following label indicates the correct direction to upright a capsized watercraft.

13

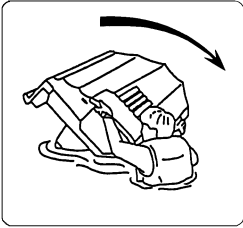

FIG-U418F-00

EJU30671

The safe use and operation of this watercraft is dependent upon the use of proper riding techniques, as well as upon the common sense, good judgment, and expertise of the operator. Every operator should know the following requirements before riding the watercraft.

- Before operating the watercraft, read this owner's/operator's manual, the Riding Practice Guide, the Riding Instruction card, and all labels on the watercraft. Also, watch the Basic Orientation Video provided with your watercraft. These materials should give you an understanding of the watercraft and its operation.
- Never allow anyone to operate this watercraft until they too have read this owner's/operator's manual, the Riding Practice Guide, the Riding Instruction card, and all labels, and, if possible, watched the Basic Orientation Video.

Showing them the video may help reinforce the information contained in these materials.

EJU30730

Limitations on who may operate the watercraft

- Yamaha recommends a minimum operator age of 16 years old.
Adults must supervise use by minors.
Know the operator age and training requirements for your state. A boating safety course is recommended and may be required in your state. You can find local rules by contacting the United States Coast Guard (USCG), the National Association of State Boating Law Administrators, or your local Power Squadron.
- This watercraft is designed to carry the operator and up to 2 passengers. Never exceed the maximum load limit or allow more than 3 persons (or 2 persons if a water-skier is being pulled) to ride the watercraft at any time.



Maximum load:
240 kg (530 lb)
Load is the total weight of cargo, operator, and passengers.

- Do not operate the watercraft with any passengers on board until you have considerable practice and experience riding alone. Operating the watercraft with passengers requires more skill. Take the time to become accustomed to the handling charac-

Safety information

teristics of the watercraft before trying any difficult maneuvers.

EJU30761

Cruising limitations

- Scan constantly for people, objects, and other watercraft. Be alert for conditions that limit your visibility or block your vision of others.

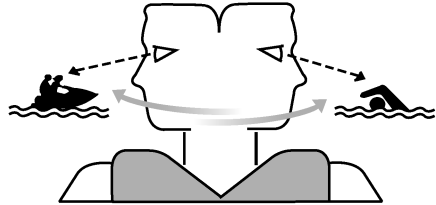

- Operate defensively at safe speeds and keep a safe distance away from people, objects, and other watercraft.
- Do not follow directly behind watercraft or other boats.
- Do not go near others to spray or splash them with water.
- Avoid sharp turns or other maneuvers that make it hard for others to avoid you or understand where you are going.
- Avoid areas with submerged objects or shallow water.
- Take early action to avoid collisions. Remember, watercraft and other boats do not have brakes.
- Do not release the throttle lever when trying to steer away from objects—you need throttle to steer. Always check throttle and steering controls before starting the watercraft.
- Ride within your limits and avoid aggressive maneuvers to reduce the risk of loss of control, ejection, and collision.
- This is a high performance boat—not a toy. Sharp turns or jumping wakes or waves can increase the risk of back/spinal injury (paralysis), facial injuries, and broken legs, an-

Safety information

cles, and other bones. Do not jump wakes or waves.

- Do not operate the watercraft in rough water, bad weather, or when visibility is poor; this may lead to an accident causing injury or death. Be alert to the possibility of adverse weather. Take note of weather forecasts and the prevailing weather conditions before setting out on your watercraft.
- As with any water sport, you should not operate your watercraft without someone else nearby. If you operate further than swimming distance from shore, you should be accompanied by another boat or watercraft, but make sure you stay a safe distance away. It's good, common sense.
- Never operate in water that is less than 60 cm (2 ft) deep from the bottom of the watercraft, otherwise you increase your chance of hitting a submerged object, which could result in injury.

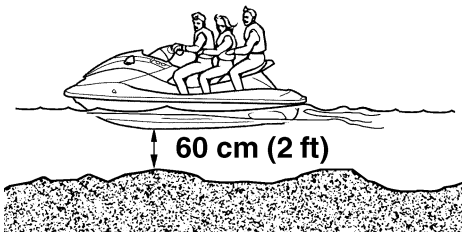

- This watercraft is not equipped with lighting required for night operation. Do not operate the watercraft after sunset or before dawn, otherwise you increase the risk of colliding

with another boat, which could result in severe injury or death.



- Follow navigation rules, and state/provincial and local laws that apply to watercraft.

Safety information

EJU30812

Operation requirements

- All riders must wear a U.S. Coast Guard (USCG) approved personal flotation device (PFD) that is suitable for personal watercraft use.
- Wear protective clothing. Severe internal injuries can occur if water is forced into body cavities as a result of falling into the water or being near the jet thrust nozzle. Normal swimwear does not adequately protect against forceful water entry into the rectum or vagina. All riders must wear a wetsuit bottom or clothing that provides equivalent protection. Such clothing includes thick, tightly woven, sturdy and snug-fitting apparel such as denim, but does not include spandex or similar fabrics, like those used in bicycle shorts.

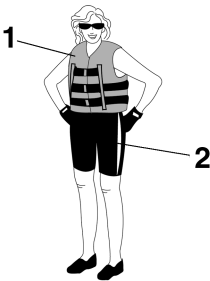

- 1 USCG approved PFD
2 Wetsuit bottom

- Eye protection is recommended to keep wind, water, and glare from the sun out of your eyes while you operate your watercraft. Restraining straps for eyewear are made which are designed to float should your eyewear fall in the water. Footwear and gloves are recommended.
- Helmets meeting Snell or DOT standards are required for IJSBA-sanctioned races. You must decide whether to wear a helmet while you ride for recreation. You should

know that a helmet could help protect you in certain kinds of accidents and that it could injure you in others.

A helmet is designed to provide some head protection. Although helmets cannot protect against all foreseeable impacts, a helmet might reduce your injuries in a collision with a boat or other obstacle.

A helmet may have potential safety hazards, as well. Falling into the water could risk the chance of the helmet catching water, commonly known as “bucketing”, and the resulting strain on your neck could cause choking, severe and permanent neck injuries, or death. A helmet could also increase the risk of an accident if it reduces your vision or hearing, or if it distracts you or increases your fatigue.

How should you decide if a helmet’s potential safety benefits outweigh its potential risks for you? Consider your particular riding conditions. Consider factors such as your riding environment and your riding style and ability. Also consider the likelihood of traffic congestion, and the water surface conditions.

If you decide to wear a helmet based upon your riding circumstances, choose one carefully. Look for a helmet designed for personal watercraft use, if possible. Consider a helmet meeting Snell or DOT standards. If you will be engaging in closed-course competition, follow the helmet requirements of the sanctioning organization.

- Never operate the watercraft after consuming alcohol or taking other drugs.
- For reasons of safety and proper care of the watercraft, always perform the pre-operation checks listed on page 59 before operating the watercraft.

Safety information

- The operator and passengers should always keep their feet on the floor of the footwell when the watercraft is in motion. Lifting your feet increases the chances of losing your balance, or hitting objects outside the watercraft with your feet. Do not give a ride to children if their feet cannot reach the floor of the footwell.
- The passengers should hold on firmly, either to the person in front of them or to the handgrip provided.



- Never allow a passenger to ride in front of the operator.
- Always consult your doctor on whether it is safe for you to ride this watercraft if you are pregnant or in poor health.
- Do not attempt to modify this watercraft. Modifications to your watercraft may reduce safety and reliability, and render the watercraft unsafe or illegal for use.
- Attach the engine shut-off cord (lanyard) to your left wrist and keep it free from the handlebars so that the engine stops if you, the operator, fall off. After riding, remove the engine shut-off cord (lanyard) from the wa-

tercraft to avoid accidental starting or unauthorized use by children or others.

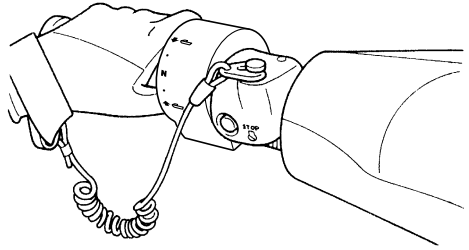

- Scan carefully for swimmers and stay away from swimming areas. Swimmers are hard to see and you could accidentally hit someone in the water.
- Avoid being hit by another boat. You should always take the responsibility to watch for traffic; other boaters may not be watching for you. If they do not see you, or if you maneuver more quickly than other boaters expect, you risk a collision.
- Maintain a safe distance from other boats and watercraft, and also watch for ski ropes or fishing lines. Obey the “Rules of the Road” and be sure to check behind you before making a turn. (See “Rules of the Road” on page 20.)
- According to the USCG, boats under 6.1 m (20 ft) in length like your watercraft must carry a fire extinguisher of a B-1 classification, with a capacity of two pounds or more when navigating in waters under USCG jurisdiction. In addition, most state and local

Safety information

boating laws also require that the fire extinguisher be approved by the USCG.

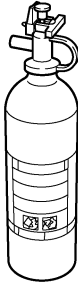

EJU30830

Recommended equipment

The following items should be carried on board your watercraft:

- Sound-signaling device

You should carry a whistle or other sound-signaling device that can be used to signal other boats. See “Rules of the Road” for more information.

- Visual distress signals

It is recommended that a U.S. Coast Guard approved pyrotechnic device be stored in a waterproof container on your watercraft. A mirror can also be used as an emergency signal. Contact a Yamaha dealer or the U.S. Coast Guard for more information.

- Watch

A watch is helpful so you will know how long you have been operating the watercraft.

- Towline

A towline can be used to tow a disabled watercraft in an emergency.

EJU36850

Hazard information

- Never start the engine or let it run for any length of time in an enclosed area. Exhaust fumes contain carbon monoxide, a colorless, odorless gas that may cause loss of consciousness and death within a short time. Always operate the watercraft in an open area.
- Do not touch the hot muffler or engine during or immediately after engine operation; they can cause serious burns.

EJU30920

Watercraft characteristics

- Jet thrust turns the watercraft. Releasing the throttle lever completely produces only minimum thrust. If you are traveling at speeds above trolling, you will have rapidly decreasing ability to steer without throttle. This model is equipped with the Yamaha Engine Management System (YEMS) that includes an off-throttle steering (OTS) system. It will activate at planing speeds should you attempt to steer the watercraft after releasing the throttle lever. The OTS system assists in turning by continuing to supply some thrust while the watercraft is decelerating, but you can turn more sharply if you apply throttle while turning the handlebars. The OTS system does not function below planing speeds or when the engine is off. Once the engine slows down, the watercraft will no longer turn in response to handlebar input until you apply throttle again or you reach trolling speed. Practice turning in an open area without obstacles until you have a good feel for this maneuver.
- This watercraft is water-jet propelled. The jet pump is directly connected to the engine. This means that jet thrust will produce some movement whenever the engine is running. There is no “neutral” position. You are in either “forward” or “reverse”, depending upon the shift lever position.
- Do not use the reverse function to slow down or stop the watercraft as it could cause you to lose control, be ejected, or impact the handlebars. This could increase the risk of back/spinal injury (paralysis), facial injuries, and broken legs, ankles, and other bones. You could also damage the shift mechanism.

Safety information

- Reverse can be used to slow down or stop during slow-speed maneuvering, such as when docking. Once the engine is idling, shift into reverse and gradually increase engine speed. Make sure that there are no obstacles or people behind you before shifting into reverse.
- Keep away from the intake grate while the engine is on. Items such as long hair, loose clothing, or PFD straps can become entangled in moving parts, resulting in severe injury or drowning.
- Never insert any object into the jet thrust nozzle while the engine is running. Severe injury or death could result from coming in contact with the rotating parts of the jet pump.

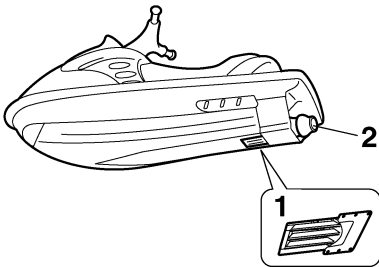

- 1 Intake grate
- 2 Jet thrust nozzle

- Stop the engine and remove the clip from the engine shut-off switch before removing

any debris or weeds, which may have collected around the jet intake.

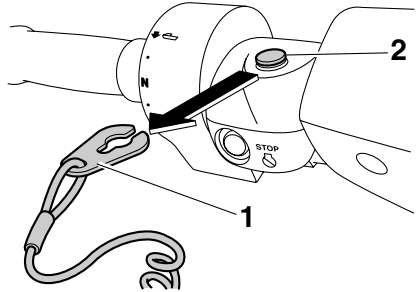

- 1 Clip
- 2 Engine shut-off switch

EJU30941

Water-skiing

You can use the watercraft for water-skiing if it has the seating capacity to carry the operator, a rearward-facing spotter, and the water-skier when he or she is not skiing.

The watercraft must also have a cleat designed to pull a ski rope; do not attach the rope to any other location.

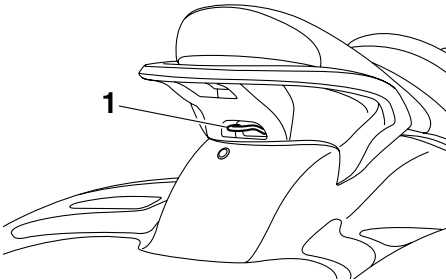

1 Cleat

It is the watercraft operator's responsibility to be alert to the safety of the water-skier and others. Know and follow all state and local water-skiing regulations in effect for the waters in which you will be operating.

The operator should be comfortable carrying passengers before attempting to pull a skier.

The following are some important considerations for minimizing risks while water-skiing.

- The skier should wear an approved PFD, preferably a brightly colored one so boat operators can see the skier.
- The skier should wear protective clothing. Severe internal injuries can occur if water is forced into body cavities as a result of falling into the water. Normal swimwear does not adequately protect against forceful water entry into the rectum or vagina. The skier should wear a wetsuit bottom or clothing that provides equivalent protection.
- A second person should be on board as a spotter to watch the skier; in most states it

is required by law. Let the skier direct the operator's control of speed and direction with hand signals.

The spotter should sit astride the rear of the seat and hold onto the handgrip with both feet firmly on the floor of the footwell for proper balance while facing to the rear to

Safety information

watch the skier's hand signals and condition.

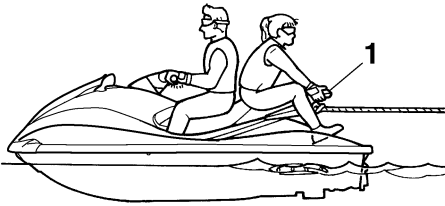

1 Handgrip

FX SHO

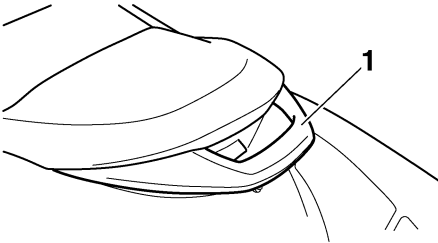

1 Handgrip

FX Cruiser SHO

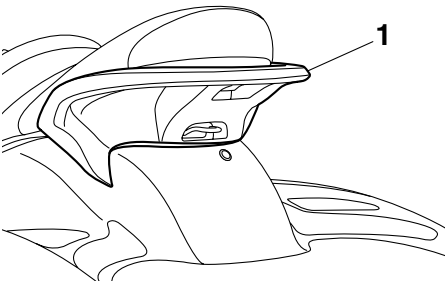

1 Handgrip

- Your control while pulling a water-skier is affected by the skier's ability, as well as water and weather conditions.
- When preparing to pull a skier, operate the watercraft at the slowest possible speed

until the watercraft is well away from the skier and slack in the ski rope is taken up. Make sure that the rope is not looped around anything.

After checking that the skier is ready and that there is no traffic or other obstacles, apply enough throttle to raise the skier.

- Make smooth, wide turns. The watercraft is capable of very sharp turns, which could exceed the abilities of the skier. Keep the skier at least 50 m (150 ft), about twice the distance of a standard ski rope, from any potential hazard.
- Be alert to the hazard of the ski rope handle snapping back at the watercraft when the skier falls or is unable to get up on the skis.
- Towing heavy or bulky objects other than skiers, such as another boat or watercraft, can cause loss of steering control and create a hazardous condition. If you must tow another boat in an emergency situation, operate slowly and cautiously.

EJU30961

Rules of the Road

Your Yamaha watercraft is legally considered a powerboat. Operation of the watercraft must be in accordance with the rules and regulations governing the waterway on which it is used.

Just as there are rules that apply when you are driving on streets and highways, there are waterway rules that apply when you are operating your watercraft. These rules are used internationally, and are also enforced by the United States Coast Guard and local agencies. You should be aware of these rules, and follow them whenever you encounter another vessel on the water.

Several sets of rules prevail according to geographic location, but are all basically the same as the International Rules of the Road. The rules presented here in this owner's/operator's manual are condensed, and have been provided for your convenience only. Consult your local U.S. Coast Guard Auxiliary or Department of Motor Vehicles for a complete set of rules governing the waters in which you will be operating your watercraft.

Steering and sailing rules

Whenever two vessels on the water meet one another, one vessel has the right-of-way; it is called the "stand-on" vessel. The vessel that does not have the right-of-way is called the "give-way" or "burdened" vessel. These rules determine which vessel has the right-of-way, and what each vessel should do.

Stand-on vessel

The vessel with the right-of-way has the duty to continue its course and speed, except to avoid an immediate collision. When you maintain your direction and speed, the other vessel will be able to determine how best to avoid you.

Give-way vessel

The vessel which does not have the right-of-way has the duty to take positive and timely action to stay out of the way of the stand-on vessel. Normally, you should not cross in front of the vessel with the right-of-way. You should slow down or change directions briefly and pass behind the other vessel. You should always move in such a way that the operator of the other vessel can see what you are doing. The General Prudential Rule regarding the right-of-way is that if a collision appears unavoidable, neither boat has the right-of-way. Both boats must avoid the collision.

In other words, follow the standard rules except when a collision will occur unless both vessels try to avoid each other. If that is the case, both vessels become give-way vessels.

Rules when encountering vessels

There are three main situations that you may encounter with other vessels which could lead to a collision unless the Steering Rules are followed:

Meeting: you are approaching another vessel head-on

Crossing: you are traveling across another vessel's path

Overtaking: you are passing or being passed by another vessel

In the following illustration, your watercraft is in the center. You should give the right-of-way to any vessels shown in the white area (you are the give-way vessel). Any vessels in the shaded area must yield to you (they are the

Safety information

give-way vessels). Both you and the meeting vessel must alter course to avoid each other.

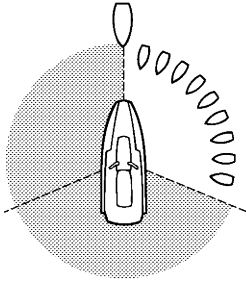

Meeting

If you are meeting another power-driven vessel head on, and are close enough to run the risk of collision, neither of you has the right-of-way. Both of you should alter course to avoid an accident. You should keep the other vessel on your port (left) side. This rule does not apply if both of you will clear one another if you continue on your set course and speed.

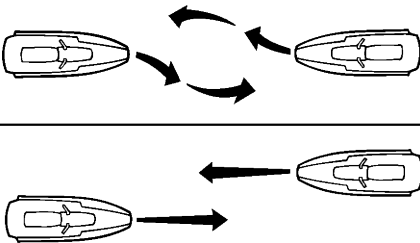

Crossing

When two power-driven vessels are crossing each other's path close enough to run the risk of collision, the vessel which has the other on the starboard (right) side must keep out of the way of the other. If the other vessel is on your starboard (right) side, you must keep out of its way; you are the give-way vessel. If the other vessel is on your port (left) side, remember that you should maintain course and direction,

provided the other vessel gives you the right-of-way as it should.

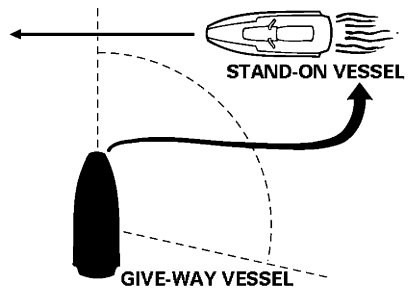

Overtaking

If you are passing another vessel, you are the give-way vessel. This means that the other vessel is expected to maintain its course and speed. You must stay out of its way until you are clear of it. Likewise, if another vessel is passing you, you should maintain your speed and direction so that the other vessel can steer itself around you.

Other special situations

There are three other rules you should be aware of when riding your watercraft around other vessels.

Narrow channels and bends

When navigating in narrow channels, you should keep to the right when it is safe and practical to do so. If the operator of a power-driven vessel is preparing to go around a bend that may obstruct the view of other water vessels, the operator should sound a prolonged blast of four to six seconds on the whistle. If another vessel is around the bend, it too should sound the whistle. Even if no reply is heard, however, the vessel should still proceed around the bend with caution. If you navigate such waters with your watercraft, you will need to carry a portable air horn, available from local marine supply stores.

Fishing vessel right-of-way

All vessels fishing with nets, lines, or trawls are considered to be “fishing vessels” under the International Rules. Vessels with trolling lines are not considered fishing vessels. Fishing vessels have the right-of-way regardless of position. Fishing vessels cannot, however, impede the passage of other vessels in narrow channels.

Sailing vessel right-of-way

Sailing vessels should normally be given the right-of-way. The exceptions to this are:

- (1) When the sailing vessel is overtaking the power-driven vessel, the power-driven vessel has the right-of-way.
- (2) Sailing vessels should keep clear of any fishing vessel.
- (3) In a narrow channel, a sailing vessel should not hamper the safe passage of a power-driven vessel that can navigate only in such a channel.

Reading buoys and other markers

The waters of the United States are marked for safe navigation by the lateral system of buoyage. Simply put, buoys and markers have an arrangement of shapes, colors, numbers, and lights to show which side of the buoy a boater should pass on when navigating in a particular direction. The markings on these buoys are oriented from the perspective of being entered from seaward (the boater is going towards the harbor). Red buoys are passed on your starboard (right) side when proceeding from open water into the harbor, and black buoys are to your port (left) side. An easy way to remember the meaning of the colors is the phrase “red right returning”. When navigating out of the harbor, your position with respect to the buoys should be reversed; red buoys should be to port and black buoys to starboard.

Many bodies of water used by boaters are entirely within the boundaries of a particular state. The Uniform State Waterway Marking System has been devised for these waters.

This system uses buoys and signs with distinctive shapes and colors to show regulatory or advisory information. These markers are white with black letters and orange borders.

Safety information

They signify speed zones, restricted areas, danger areas, and general information.

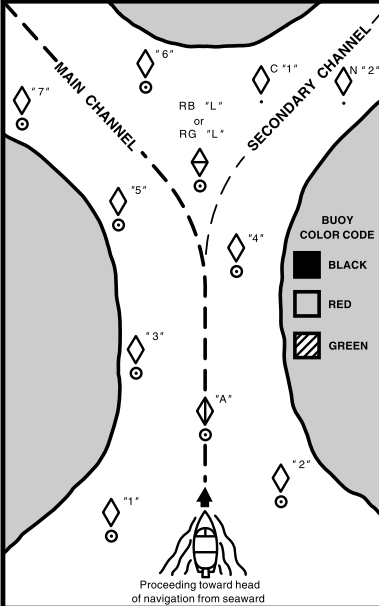
	<p>MAIN CHANNEL BUOYS</p> <p>◇ "1" "3" "5" "7"</p> <p>○ LIGHTED BUOY (Port Hand)</p> <p>Odd number, increasing toward head of navigation, Leave to port (left) proceeding upstream.</p> <p>White Light OR Green Light</p> <p>old OR new</p>
<p>SECONDARY CHANNEL BUOYS STARTS NEW NUMBERING SYSTEM</p>	<p>◇ "2" "4" "6"</p> <p>○ LIGHTED BUOY (Starboard Hand)</p> <p>Even number, increasing toward head of navigation, Leave to starboard (right) proceeding upstream.</p> <p>White Light OR Red Light</p> <p>old OR new</p>
<p>◇ C "1"</p> <p>CAN BUOY Odd number. Leave to port.</p> <p>old OR new</p>	<p>◇ "A"</p> <p>○ LIGHTED SAFE WATER BUOY</p> <p>No number. Marks midchannel, pass on either side. Letter has no lateral significance, used for identification and location purposes.</p> <p>White Light OR Top Mark White Light</p> <p>old OR new</p>
<p>◇ N "2"</p> <p>NUN BUOY Even number. Leave to starboard</p> <p>No change</p>	<p>◇ RB "L" OR ◇ RG "L"</p> <p>○ LIGHTED PREFERRED CHANNEL TO PORT BUOY</p> <p>No number. Topmost band red – preferred channel is to left of buoy. Letter has no lateral significance, used for identification and location purposes.</p> <p>Red or White Light OR Red Light</p> <p>old OR new</p>

Remember, markings may vary by geographic location. Always consult local boating authorities before riding your watercraft in unfamiliar waters.

EJU30980

To get more boating safety information

Be informed about boating safety. Additional publications and information can be obtained from many organizations, including the following.

United States Coast Guard

Consumer Affairs Staff (G-BC)

Office of Boating, Public, and Consumer Affairs

U.S. Coast Guard Headquarters

Washington, D.C. 20593-0001

Boating Safety Hotline: 1-800-368-5647

Other sources

You can find local rules by contacting the National Association of State Boating Law Administrators, or your local Power Squadron.

Watercraft Education and Training

The Online Boating Safety Course, available through the watercraft section of the yamaha-motor.com website, is a free, 50 question learning course available to the public. Upon successful completion of 80 percent or better, the user can request a certificate of completion by mail or can download one immediately. The Online Boating Safety Course, provided by the Boat/US Foundation, is approved by the National Association of State Boating Law Administrators (NASBLA) and recognized by the United States Coast Guard. This course meets the education requirement for those states that recognize non-proctored, NASBLA-approved courses.

Yamaha is the watercraft industry's leading manufacturer to build awareness and support for boating education. In 1997, Yamaha launched its GET W.E.T. (Watercraft Education and Training) initiative and has since reached out to over one million Americans promoting the benefits of boating education.

The Online Boating Safety Course:
<http://www.boatus.com/onlinecourse/>

Safety information

EJU30991

Enjoy your watercraft responsibly

You share the areas you enjoy when riding your watercraft with others and with nature. So your enjoyment includes a responsibility to treat these other people, and the lands, waters, and wildlife with respect and courtesy.

Whenever and wherever you ride, think of yourself as the guest of those around you. Remember, for example, that the sound of your watercraft may be music to you, but it could be just noise to others. And the exciting splash of your wake can make waves others won't enjoy.

Avoid riding close to shoreline homes and waterfowl nesting areas or other wildlife areas, and keep a respectful distance from fishermen, other boats, swimmers, and populated beaches. When travel in areas like these is unavoidable, ride slowly and obey all laws.

Proper maintenance is necessary to ensure that the exhaust emission and sound levels of your watercraft will continue to be within regulated limits. You have the responsibility to make sure that the recommended maintenance in this owner's/operator's manual is carried out.

Remember, pollution can be harmful to the environment. Do not refuel or add oil where a spill could cause damage to nature. Remove your watercraft from the water and move it away from the shoreline before refueling. Dispose of water and any fuel and oil residue in the engine compartment according to local regulations. And keep your surroundings pleasant for the people and wildlife that share the waterways: don't litter.

When you ride responsibly, with respect and courtesy for others, you help ensure that our

waterways stay open for the enjoyment of a variety of recreational opportunities.

Features and functions

EJU31010

Location of main components

Front view

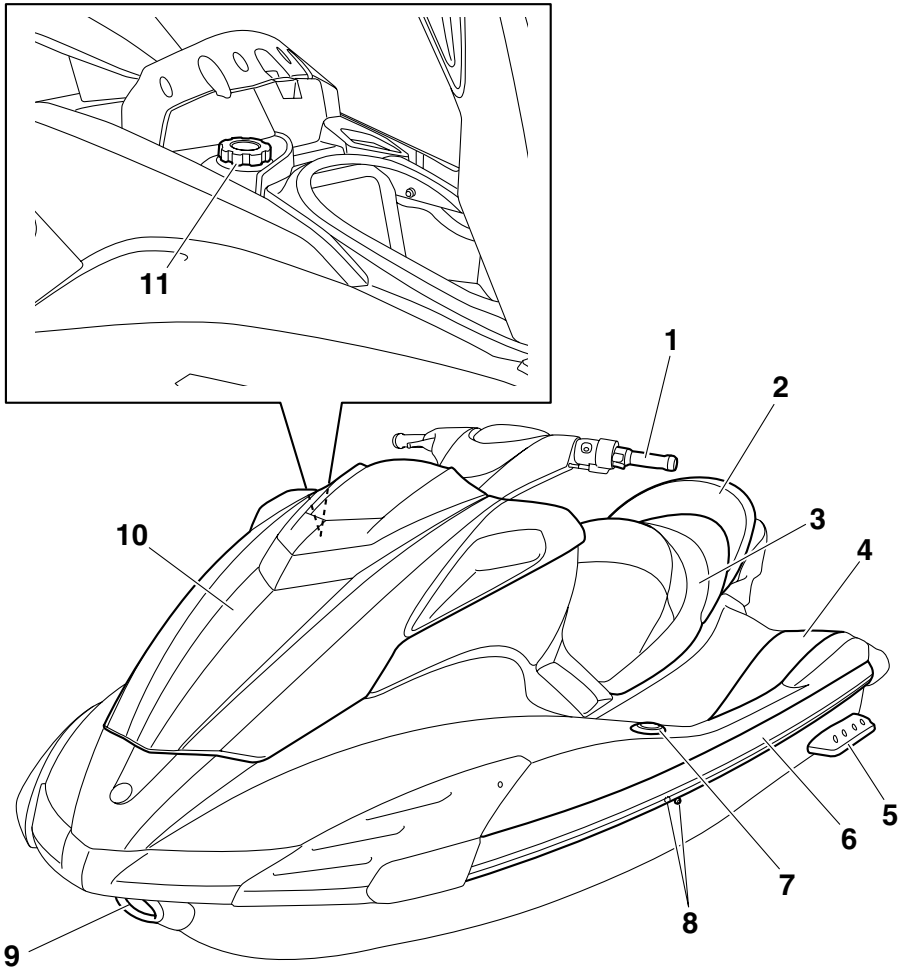

1 Handlebars

2 Rear seat

3 Front seat

4 Footwell

5 Sponsons

6 Gunwale

7 Pull-up cleat (for FX Cruiser SHO)

8 Cooling water pilot outlet

9 Bow eye

10 Hood

11 Fuel tank filler cap

Features and functions

Rear view

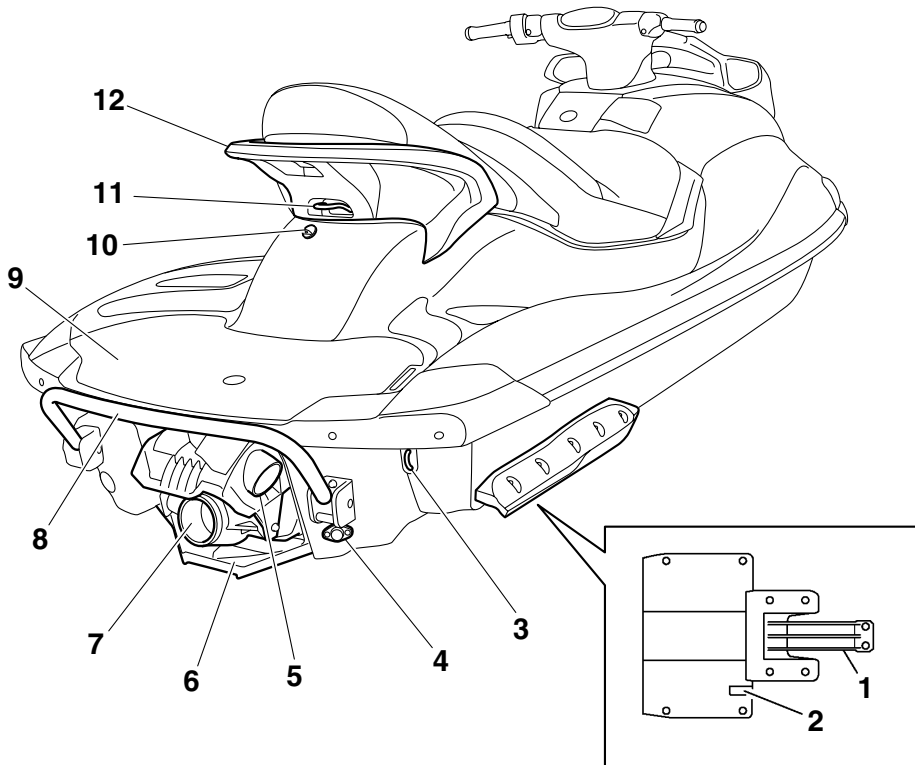

- 1 Intake grate
- 2 Speed sensor
- 3 Stern eyes
- 4 Stern drain plugs
- 5 Reverse gate
- 6 Ride plate
- 7 Jet thrust nozzle
- 8 Reboarding step
- 9 Boarding platform
- 10 Electric bilge pilot outlet
- 11 Cleat
- 12 Handgrip

Features and functions

Control system

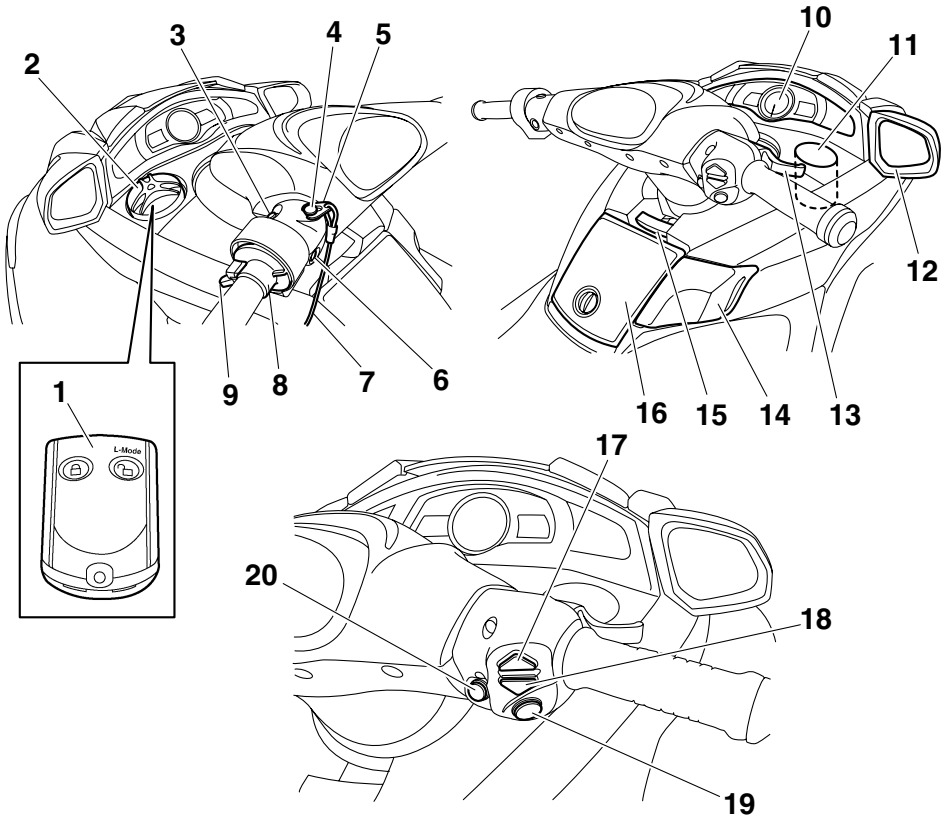

- 1 Remote control transmitter
- 2 Watertight compartment
- 3 Start switch
- 4 Engine shut-off switch
- 5 Clip
- 6 Engine stop switch
- 7 Engine shut-off cord (lanyard)
- 8 Quick Shift Trim System (QSTS) selector
- 9 QSTS selector lock lever
- 10 Multifunction information center
- 11 Beverage holder
- 12 Rearview mirrors
- 13 Throttle lever
- 14 Shift lever
- 15 Tilt lever
- 16 Glove compartment
- 17 Up switch (for cruise assist)
- 18 Down switch (for cruise assist)
- 19 "SET" switch (for cruise assist)
- 20 "NO-WAKE MODE" switch

Features and functions

Engine compartment

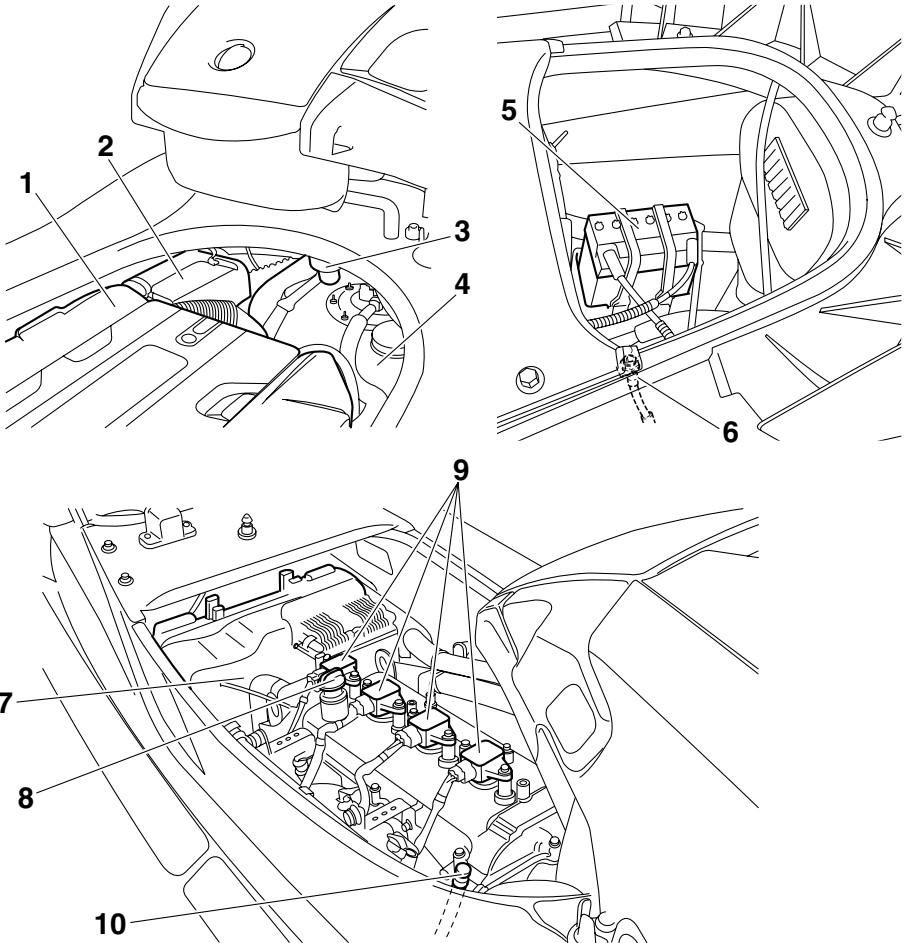

- 1 Engine cover
- 2 Air filter case
- 3 Water separator
- 4 Fuel tank
- 5 Battery
- 6 Flushing hose connector
- 7 Electrical box
- 8 Engine oil filler cap
- 9 Spark plug cap
- 10 Dipstick

EJU31021

Operation of controls and other functions

EJU31041

Seats

To remove the rear seat:

Pull the rear seat latch up, and then pull the seat off.

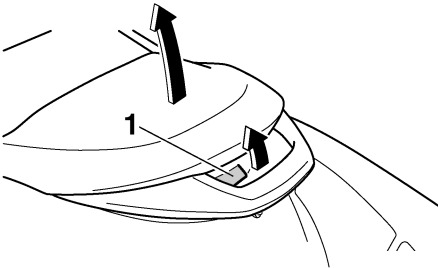

1 Seat latch

To install the rear seat:

Insert the projections on the front of the seat into the stays on the deck, and then push the rear of the seat down to lock it in place. Make

sure that the seat is securely installed before operating the watercraft.

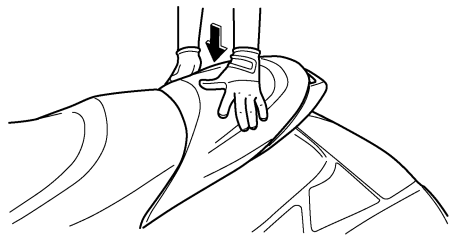

To remove the front seat:

- (1) Remove the rear seat.
- (2) Pull the front seat latch up, and then pull the seat off.

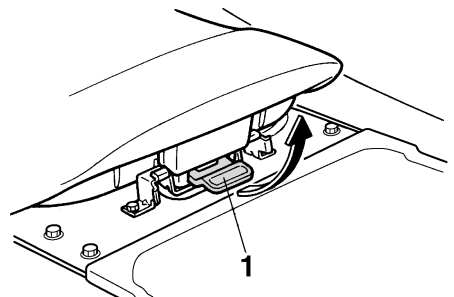

1 Seat latch

To install the front seat:

- (1) Insert the projections on the front of the seat into the stays on the deck, and then

Features and functions

push the rear of the seat down to lock it in place.

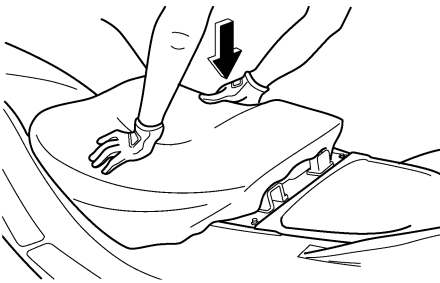
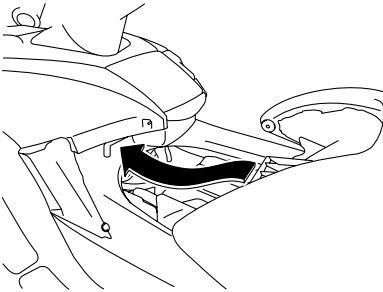

- (2) Install the rear seat. Make sure that the seats are securely installed before operating the watercraft.

EJU36682

Hood

To open the hood, pull the visor up, and then lift up the hood.

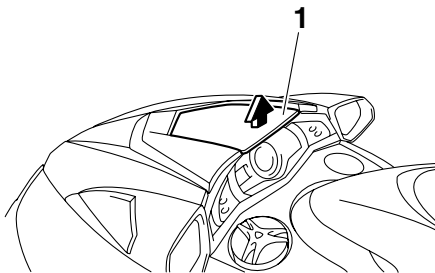

1 Visor

To close the hood, push down on the center of the hood until it latches securely. Make sure that the hood is securely closed before operating the watercraft.

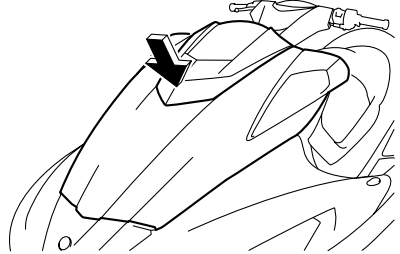

EJU36691

Fuel tank filler cap

The fuel tank filler cap is located under the hood.

To remove the fuel tank filler cap, open the hood, and then turn the cap counterclockwise. (See page 31 for hood opening and closing procedures.)

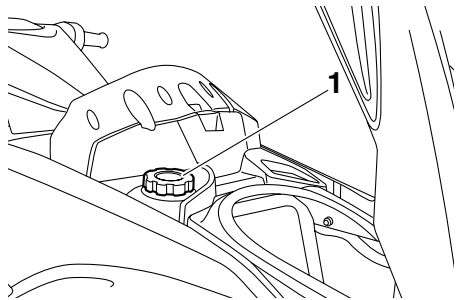

1 Fuel tank filler cap

To install the fuel tank filler cap, turn it clockwise until it stops. Make sure that the fuel tank filler cap and the hood are securely closed before operating the watercraft.

EJU34844

Remote control transmitter

The Yamaha Security System and low-RPM mode settings are selected using the remote control transmitter. (See "Yamaha Security

Features and functions

System” on page 39 for information on using the remote control transmitter.)



The Yamaha Security System and low-RPM mode settings can only be selected using the remote control transmitter.

Store the remote control transmitter carefully so it will not be lost. When operating the watercraft, store the transmitter in the transmitter holder provided in the watertight compartment.

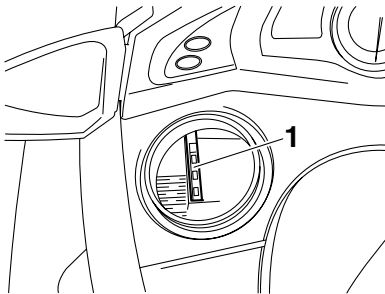

1 Transmitter holder

ECJ00751

NOTICE

- **The remote control transmitter is not completely waterproof. Do not submerge the transmitter or operate it underwater. If the transmitter is submerged, dry it with a soft, dry cloth, and then check that it is operating properly. If the transmitter is not operating properly, contact a Yamaha dealer.**

- **Keep the remote control transmitter away from high temperatures and do not place it in direct sunlight.**
- **Do not drop the remote control transmitter, subject it to strong shocks, or place any heavy items on it.**
- **Use a soft, dry cloth to clean the remote control transmitter. Do not use detergent, alcohol, or other chemicals.**
- **Do not attempt to disassemble the remote control transmitter yourself. Otherwise, the transmitter may not operate properly. If the transmitter needs a new battery, contact a Yamaha dealer.**

TIP:

- While the engine is running, input from the remote control transmitter is not received.
- If you accidentally lose your remote control transmitter, contact a Yamaha dealer.

This device complies with Part 15 of the FCC Rules. Operation is subject to the following two conditions: (1) this device may not cause harmful interference, and (2) this device must accept any interference received, including interference that may cause undesired operation.

ECJ00030

NOTICE

Changes or modifications not expressly approved by the party responsible for compliance could void the user's authority to operate the remote control transmitter.

Features and functions

EJU31150

Engine stop switch

Push the engine stop switch (red button) to stop the engine normally.

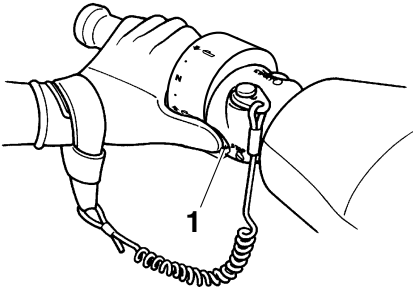

1 Engine stop switch

EJU31161

Engine shut-off switch

Attach one end of the engine shut-off cord (lanyard) to your left wrist, and then insert the clip on the other end under the engine shut-off switch (black button). The engine will stop automatically when the clip is removed from the switch, such as if the operator falls off the watercraft. Remove the engine shut-off cord (lanyard) from the watercraft when the engine

is not running to prevent unauthorized use by children or others.

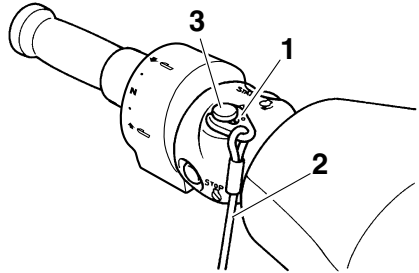

- 1 Clip
- 2 Engine shut-off cord (lanyard)
- 3 Engine shut-off switch

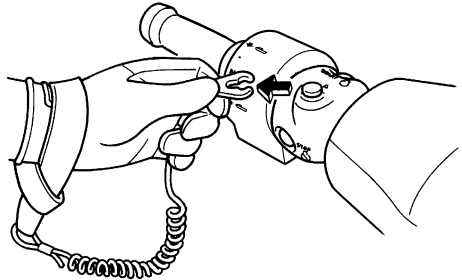

EJU36281

Start switch

Push the start switch (green button) to start the engine.

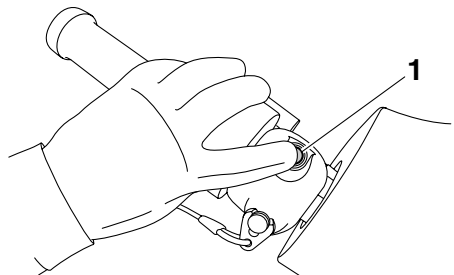

1 Start switch

The engine will not start under any of the following conditions:

Features and functions

- Lock mode of the Yamaha Security System has been selected. (See page 40 for Yamaha Security System lock and unlock mode selection procedures.)
- Clip is removed from the engine shut-off switch.
- Throttle lever is squeezed.

EJU36700

Right handlebar switches

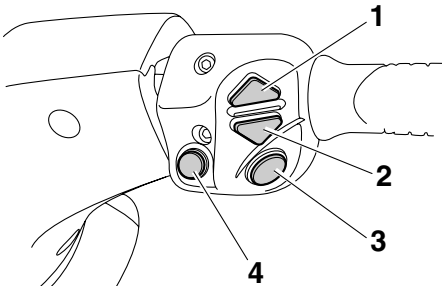

- 1 Up switch
- 2 Down switch
- 3 "SET" switch
- 4 "NO-WAKE MODE" switch

EJU36710

"SET" switch

Push this switch to activate the cruise assist. (See page 42 for more information.)

EJU36720

Up and down switches

Push these switches to increase or decrease the engine speed while the cruise assist is operating. (See page 42 for more information.)

EJU36730

"NO-WAKE MODE" switch

Push this switch to activate or deactivate the no-wake mode. (See page 41 for more information.)

EJU31210

Throttle lever

Squeeze the throttle lever to increase engine speed.

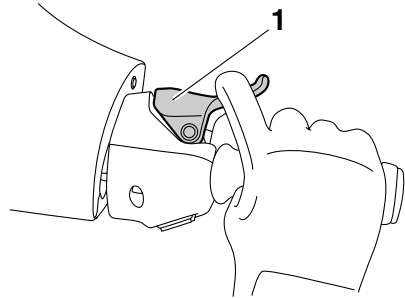

1 Throttle lever

Release the throttle lever to decrease engine speed or to return it to the idle position.

EJU36740

Cooling water pilot outlets

This watercraft is equipped with cooling water pilot outlets on the port (left) and starboard (right) sides of the watercraft.

When the engine is running, cooling water is circulated in the engine, and then it is discharged from the pilot outlets.

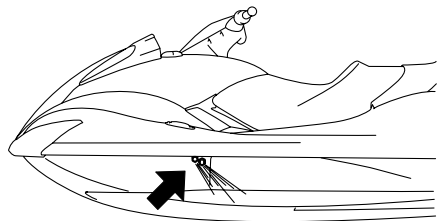

To check for proper operation of the cooling system, check that water is being discharged from the port (left) pilot outlets. If water is not being discharged from these outlets, cooling water may not be circulating in the engine. When this occurs, stop the engine and check

Features and functions

for the cause. (See pages 50 and 101 for more information.)

TIP:

- If the cooling water passages are dry, it will take about 60 seconds for the water to reach the outlets after the engine is started.
- Water discharge may not be constant at idle, therefore, open the throttle a little to check that water discharges properly.

EJU31260

Steering system

Your watercraft can be steered by turning the handlebars in the direction you wish to travel.

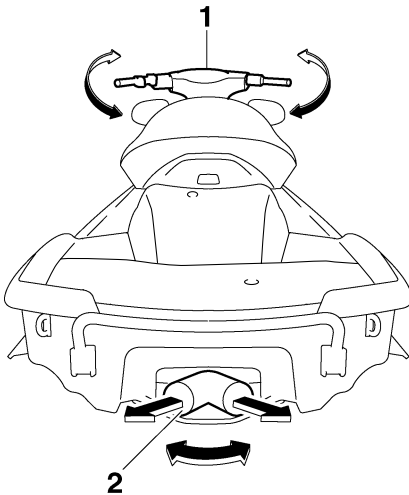

- 1 Handlebar
- 2 Jet thrust nozzle

When the handlebars are turned, the angle of the jet thrust nozzle is changed, and the direction of the watercraft is changed accordingly. Since the strength of the jet thrust determines the speed and degree of a turn, throttle must always be applied when attempting a turn, except at trolling speed.

This model is equipped with the Yamaha Engine Management System (YEMS) that in-

cludes an off-throttle steering (OTS) system. It will activate at planing speeds should you attempt to steer the watercraft after releasing the throttle lever. The OTS system assists in turning by continuing to supply some thrust while the watercraft is decelerating, but you can turn more sharply if you apply throttle while turning the handlebars.

The OTS system does not function below planing speeds or when the engine is off. Once the engine slows down, the watercraft will no longer turn in response to handlebar input until you apply throttle again or you reach trolling speed.

EJU31291

Tilt lever

The tilt lever is located in front of the glove compartment and is used to adjust the tilt of the handlebars. **WARNING! Never pull the tilt lever during operation, otherwise the handlebars may suddenly change position, which may lead to an accident.** [EJVJ00041]

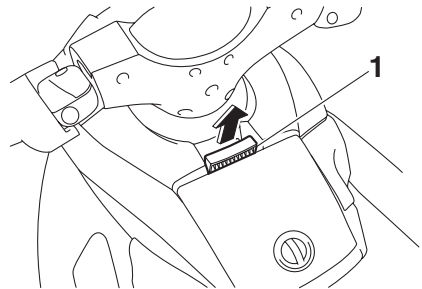

- 1 Tilt lever

Features and functions

To adjust the tilt, pull the tilt lever up, and then move the handlebars up or down to the desired position.

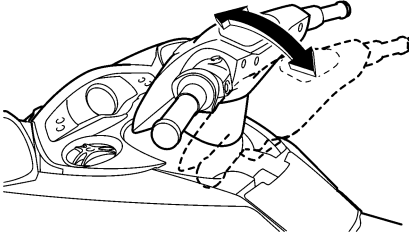

Make sure that the tilt lever returns to its original position and that the handlebars are locked in place after adjusting them.

EJU31301

Shift lever

The shift lever is located on the starboard (right) side of the watercraft and is used to control the reverse gate, which allows the watercraft to move in reverse or forward.

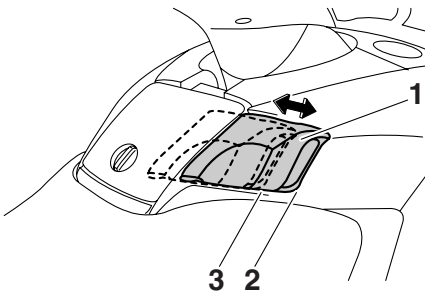

- 1 Shift lever
- 2 Forward position
- 3 Reverse position

When the shift lever is in the reverse position, the watercraft can be launched from a trailer, or backed up out of tight spots where you cannot turn around easily.

EJU31312

Quick Shift Trim System (QSTS) selector

The QSTS selector is located at the left handlebar grip and is used to adjust the trim angle of the watercraft.

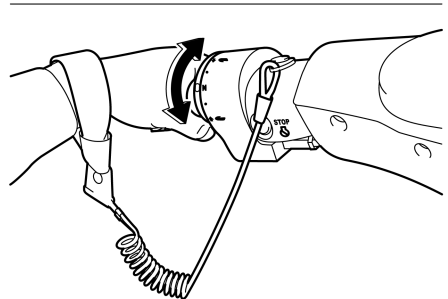
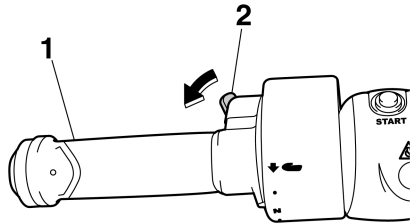

- 1 Quick Shift Trim System (QSTS) selector
- 2 QSTS selector lock lever

Operating the QSTS selector changes the angle of the jet thrust nozzle vertically. This changes the trim angle of the watercraft.

Features and functions

There are 5 positions: 2 bow-down positions (a) and (b), neutral “N”, and 2 bow-up positions (c) and (d).

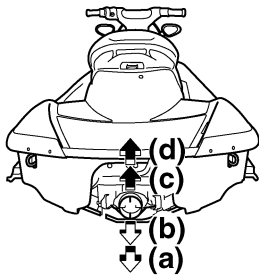
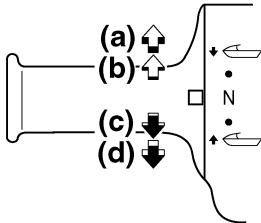

To change the trim angle:

- (1) Reduce engine speed to less than 3000 r/min.
- (2) Squeeze the QSTS selector lock lever, and then turn the QSTS selector to the desired position. **NOTICE: Do not turn the QSTS selector while operating the watercraft at an engine speed of 3000 r/min or more, otherwise damage could occur to the QSTS.** [ECJ00012]
- (3) Release the lock lever to lock the QSTS selector.

The neutral “N” position will provide good performance for most operating conditions.

To enhance particular types of performance, select bow down or bow up.

(d) ↑

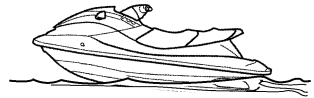

(c) ↑

N

(b) ↓

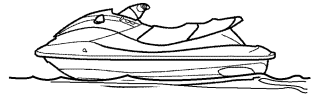

(a) ↓



EJU31330

Bow down

Turn the QSTS selector to (a) or (b) and the bow will go down while the watercraft is on plane.

Bow down puts more of the bow in the water. This gives the watercraft more “hook”, which enhances turning performance. This position will also help the watercraft get up on plane more quickly.

At higher speeds, however, the watercraft will have a greater tendency to “bow steer” and follow waves and wakes in the water. Fuel economy and maximum speed are also reduced.

EJU31340

Bow up

Turn the QSTS selector to (c) or (d) and the bow will go up while the watercraft is on plane. Bow up puts less of the bow in the water. There is less water resistance, so straight-

Features and functions

ahead acceleration when on plane and top speed are enhanced.

In some conditions, however, the watercraft may tend to “porpoise” (hop in the water). If the watercraft is porpoising, select neutral or bow down.

EJU31361

Handgrip

The handgrip provides a handhold for boarding the watercraft and for a spotter when facing rearward. **WARNING! Do not use the handgrip to lift the watercraft. The handgrip is not designed to support the watercraft’s weight. If the handgrip breaks, the watercraft could fall, which could result in severe injury.** [EWJ00021]

FX SHO

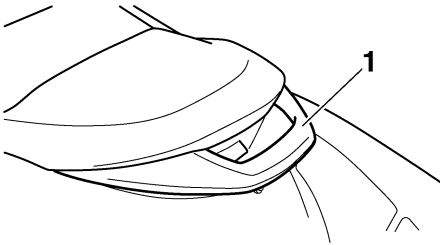

1 Handgrip

FX Cruiser SHO

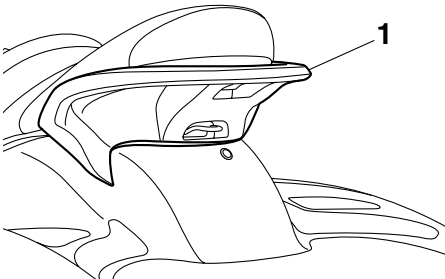

1 Handgrip

EJU34862

Reboarding step

The reboarding step provides a handhold and footstep for boarding the watercraft.

WARNING! Do not use the reboarding step to lift the watercraft. The reboarding step is not designed to support the watercraft’s weight. If the reboarding step breaks, the watercraft could fall, which could result in severe injury. [EWJ01211]

ECJ00742

NOTICE

Use the reboarding step only to board the watercraft in the water. Do not use the reboarding step for any other purpose. The watercraft can be damaged.

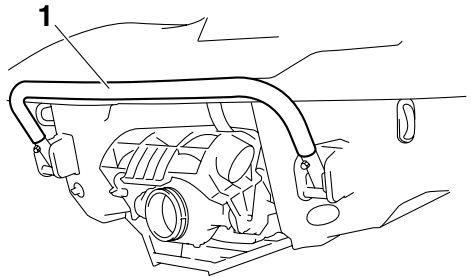

1 Reboarding step

EJU34870

Bow eye

The bow eye is located at the bow of the watercraft.

Features and functions

The bow eye is used to attach a rope to the watercraft when transporting, mooring, or towing it in an emergency.

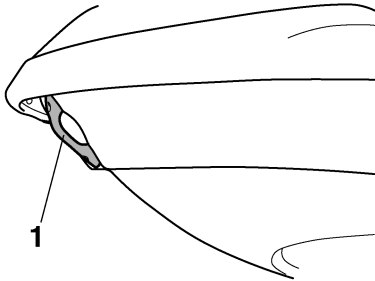

1 Bow eye

EJU34880

Stern eyes

The stern eyes are located at the stern of the watercraft.

The stern eyes are used to attach a rope to the watercraft when transporting or mooring it.

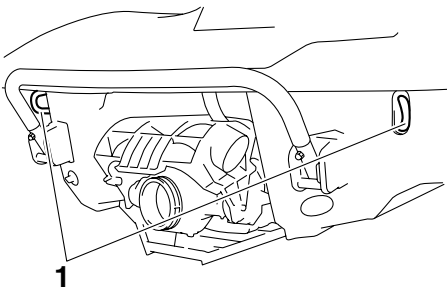

1 Stern eye

EJU34891

Pull-up cleats (for FX Cruiser SHO)

The pull-up cleats are used to attach a rope to the watercraft when mooring it.

To use a pull-up cleat, pull it up. **WARNING! Do not use the pull-up cleats to lift the watercraft. The pull-up cleats are not designed to support the watercraft's weight. If the pull-up cleats break, the watercraft**

could fall, which could result in severe injury. [EWJ00821]

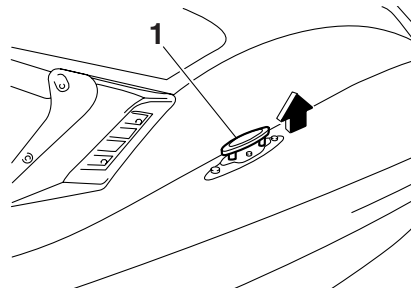

1 Pull-up cleat

EJU31370

Yamaha Engine Management System (YEMS)

This model is equipped with an integrated, computerized management system that controls and adjusts ignition timing, fuel injection, engine diagnostics, and the off-throttle steering (OTS) system.

EJU31381

Yamaha Security System

The Yamaha Security System functions to help prevent unauthorized use or theft of the watercraft. The engine cannot be started if the security system is in the lock mode. The engine can only be started in the unlock mode. The lock and unlock modes of the security system are selected using the remote control transmitter that is included with this watercraft.

TIP:

Since the watercraft is programmed to recognize the internal code from this transmitter only, the security system setting can only be changed with this transmitter. If you lose the remote control transmitter or if it does not operate properly, contact a Yamaha dealer.

Features and functions

(See page 31 for information on using the remote control transmitter.)

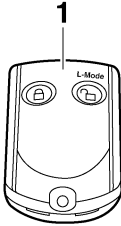

1 Remote control transmitter

EJU36771

Yamaha Security System settings

The Yamaha Security System settings are selected by pressing the lock or unlock button on the remote control transmitter briefly.

Depending on the selected Yamaha Security System setting, the “UNLOCK” indicator light will come on or go off.

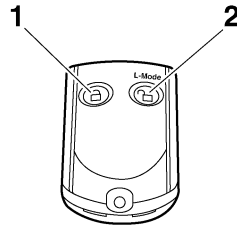

- 1 Lock button
- 2 Unlock button

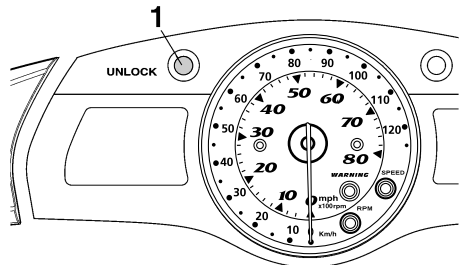

- 1 “UNLOCK” indicator light

TIP:

The lock and unlock modes of this system can only be selected while the engine is stopped.

LOCK

When the lock button on the remote control transmitter is pressed briefly, the beeper sounds once and the “UNLOCK” indicator light goes off. This indicates the lock mode is selected and the engine cannot be started.

UNLOCK

When the unlock button on the remote control transmitter is pressed briefly, the beeper sounds two or three times and the “UNLOCK” indicator light comes on. This indicates the

Features and functions

unlock mode is selected and the engine can be started.

TIP:

The beeper sounds two times for the normal mode or three times for the low-RPM mode. (See the items in “Selecting the operation mode” for operation mode information.)

Number of beeps	Yamaha Security System mode	Engine can be started
●	Lock	NO
● ●	Unlock (normal mode)	YES
● ● ●	Unlock (low-RPM mode)	YES

If neither the start switch nor the remote control transmitter is operated within 25 seconds after the unlock button is pressed to select the unlock mode, the multifunction information center will turn off and enter a standby state. If the multifunction information center is in the standby state, start the engine to return the display and the indicator lights to their state before the center turned off.

EJU36781

Selecting the operation mode

There are two operation modes in the unlock mode of the Yamaha Security System: the normal mode and the low-RPM mode. The normal mode and low-RPM mode can only be selected when the engine is stopped in the unlock mode. Press the unlock button on the remote control transmitter for more than 4 seconds to switch between the normal mode and the low-RPM mode.

Normal mode

The watercraft can be ridden normally in this mode.

If the beeper sounds two times, the normal mode is activated.

Low-RPM mode

Maximum engine speed (r/min) in this mode is limited to approximately 70% of the maximum engine speed in the normal mode.

If the beeper sounds three times, the low-RPM mode is activated and the “L-MODE” indicator light comes on.

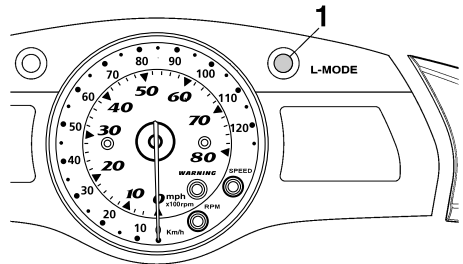

1 “L-MODE” indicator light

EJU37011

No-wake mode

The no-wake mode is a function that maintains the engine speed at a fixed setting for operating the watercraft at low speeds. This function can be used only for forward operation of the watercraft.

Activating and deactivating the no-wake mode

Activation of the no-wake mode will be confirmed by the beeper and the digital speedometer display.

Number of beeps	No-wake mode operation	Digital speedometer display
● ● ●	Activated	Starts flashing
● ●	Deactivated	Stops flashing

TIP:

The beeps and the flashing digital speedometer display also indicate the activation of the cruise assist. (See page 42 for more information.)

Features and functions

To activate the no-wake mode:

TIP:

The no-wake mode cannot be activated immediately after starting the engine. After starting the engine, wait for 5 seconds or more before activating the mode.

- (1) Release the throttle lever.
- (2) Check that the shift lever is in the forward position.

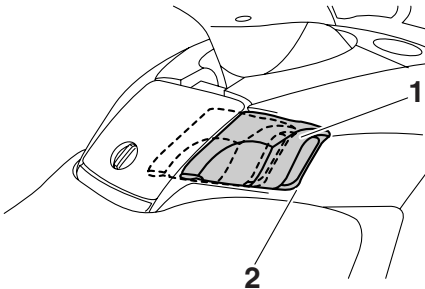

- 1 Shift lever
- 2 Forward position

TIP:

The no-wake mode cannot be activated when the shift lever is in the reverse position.

- (3) Push and hold the "NO-WAKE MODE" switch. When the no-wake mode is activated, the beeper sounds three times quickly and "5" (when miles are selected) or "8" (when kilometers are selected) starts flashing in the digital speedometer display. Keep the throttle lever in the idle position when the no-wake mode is activated.

TIP:

The digital speedometer display flashes continually while the no-wake mode is activated.

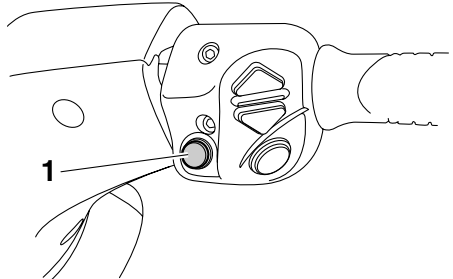

1 "NO-WAKE MODE" switch

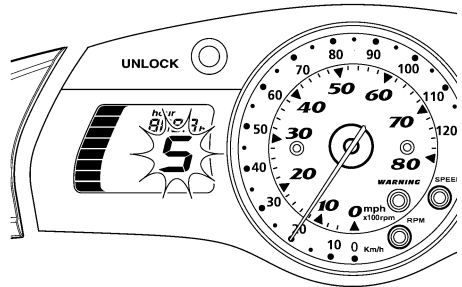

To deactivate the no-wake mode:

Perform one of the following procedures. The beeper sounds two times quickly and the digital speedometer display stops flashing when the no-wake mode is deactivated.

- Push the "NO-WAKE MODE" switch.
- Squeeze the throttle lever.

TIP:

The no-wake mode is also deactivated when the engine is stopped.

EJU37022

Cruise assist

The cruise assist is a function for maintaining a desired engine speed within a fixed range while operating the watercraft.

Features and functions

Activating and deactivating the cruise assist

Activation of the cruise assist will be confirmed by the beeper and the digital speedometer display.

Number of beeps	Cruise assist operation	Digital speedometer display
● ● ●	Activated	Starts flashing
● ●	Deactivated	Stops flashing
●	Engine speed increases or decreases	Continues flashing

TIP:

The beeps and the flashing digital speedometer display also indicate the activation of the no-wake mode. (See page 41 for more information.)

To activate the cruise assist:

TIP:

- The cruise assist can only be set between engine speeds of approximately 3000 r/min and approximately 7000 r/min.
 - The cruise assist cannot be activated in the low-RPM mode. (See the items in 41 for operation mode information.)
- (1) Operate the throttle lever until the desired engine speed is reached.
 - (2) Once the engine speed reaches the desired cruise assist setting, push the “SET” switch. When the cruise assist is activated, the beeper sounds three times quickly and the digital speedometer display starts flashing. To keep the cruise assist activated, be sure to keep the throttle lever squeezed further than the position at which the cruise assist was set; releasing the throttle lever will deactivate the cruise assist.

TIP:

The digital speedometer display flashes continually while the cruise assist is activated. Make sure that the beeper has sounded and the digital speedometer display is flashing before squeezing the throttle lever to the full throttle position. If the speedometer display is not flashing, the cruise assist is not activated

Features and functions

and the engine will respond normally to the throttle.

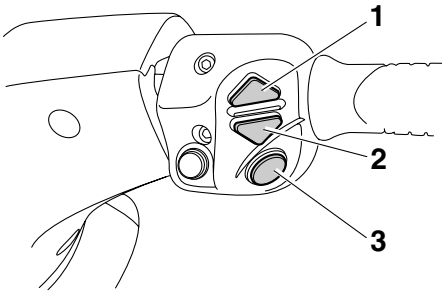

- 1 Up switch
- 2 Down switch
- 3 "SET" switch

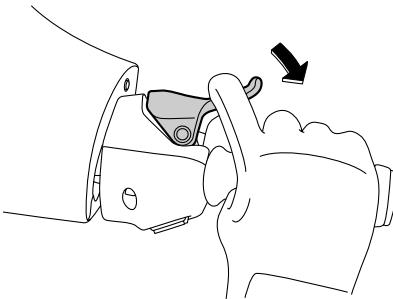
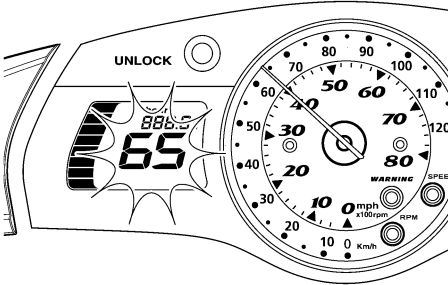

TIP:

Once the cruise assist is activated, the engine speed can be increased by pushing the up switch or decreased by pushing the down switch. Each time a switch is pushed, the beeper will sound one time quickly and the

engine speed will change. However, the adjustment is limited to a maximum of five increments above or below the initial cruise assist setting.

To deactivate the cruise assist:

Relax your grip on the throttle lever. The beeper sounds two times quickly and the digital speedometer display stops flashing when the cruise assist is deactivated.

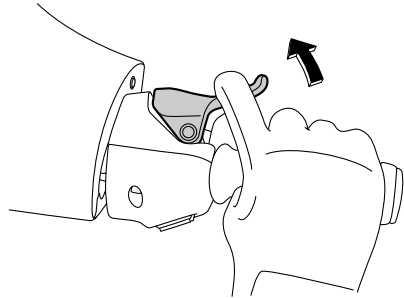

TIP:

The cruise assist is also deactivated when the engine is stopped.

EJU34903

Multifunction information center

The multifunction information center is equipped with the following three main com-

Features and functions

ponents for help and convenience in operating the watercraft.



- 1 Analog speedometer/tachometer and indicator lights
- 2 Left multifunction display and operation buttons
- 3 Right multifunction display and operation buttons (for FX Cruiser SHO)

When the multifunction information center starts operating, the analog speedometer/tachometer makes one sweep, all displays light up for 2 seconds, and then the meter starts to operate normally.

The multifunction information center will continue to operate for 25 seconds after the engine stops.

EJU34930

Analog speedometer/tachometer and indicator lights

This watercraft is equipped with the following meter and indicator lights.

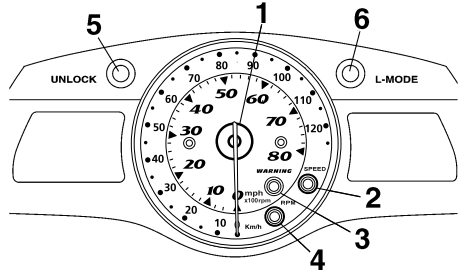

- 1 Analog speedometer/tachometer
- 2 "SPEED" indicator light
- 3 "WARNING" indicator light
- 4 "RPM" indicator light
- 5 "UNLOCK" indicator light
- 6 "L-MODE" indicator light

EJU36791

Analog speedometer/tachometer

The analog speedometer/tachometer can be used as a speedometer or a tachometer.

To switch between the speedometer and the tachometer functions, push the "Speed/RPM" button for at least 1 second when the multifunction information center is operating.

The "SPEED" indicator light comes on when the analog speedometer is selected. The

Features and functions

“RPM” indicator light comes on when the analog tachometer is selected.

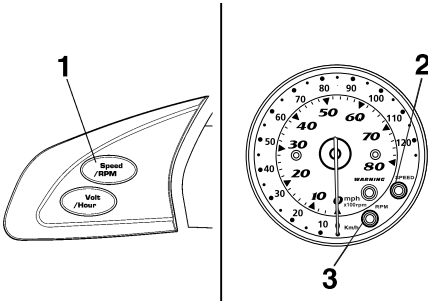

- 1 “Speed/RPM” button
- 2 “SPEED” indicator light
- 3 “RPM” indicator light

The “SPEED” indicator light blinks three times, then comes on, if miles are selected as the display units when the analog speedometer/tachometer is switched to the speedometer function.

Analog speedometer

The analog speedometer shows the watercraft speed against water.

The large inner numbers on the meter show the watercraft speed in miles per hour (mph) and the small outer numbers show the speed in kilometers per hour (km/h) when the speedometer function is selected.

Analog tachometer

The analog tachometer shows the engine speed.

The large inner numbers on the meter show the engine speed ($\times 100$ r/min) when the tachometer function is selected.

EJU36800

“SPEED” indicator light

The “SPEED” indicator light comes on when the analog speedometer is selected.

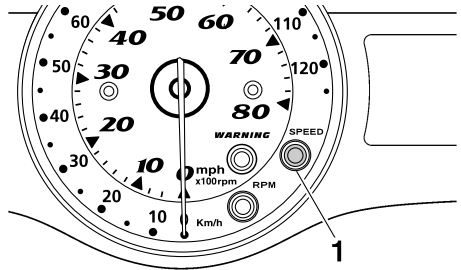

- 1 “SPEED” indicator light

The “SPEED” indicator light blinks three times in the following instances:

- The analog speedometer/tachometer is switched to the speedometer function when miles are selected as the display units.
- The display units of the multifunction information center are switched to miles from kilometers.
- Miles are selected as the display units when the multifunction information center starts operating.

EJU34960

“RPM” indicator light

The “RPM” indicator light comes on when the analog tachometer is selected.

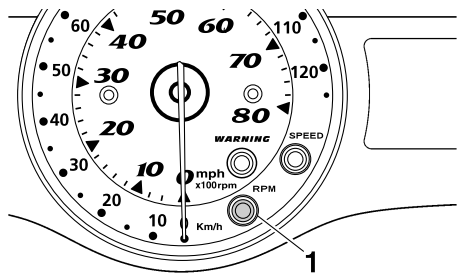

- 1 “RPM” indicator light

Features and functions

EJU34980

“WARNING” indicator light

The “WARNING” indicator light blinks or comes on, together with a warning indicator, when a malfunction has occurred.

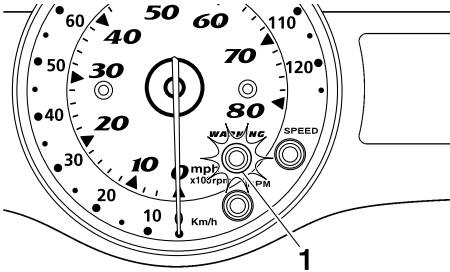

1 “WARNING” indicator light

EJU34990

“UNLOCK” indicator light

The “UNLOCK” indicator light comes on when the unlock mode of the Yamaha Security System is selected. The watercraft can be ridden normally when this light is on. (See page 40 for more information.)

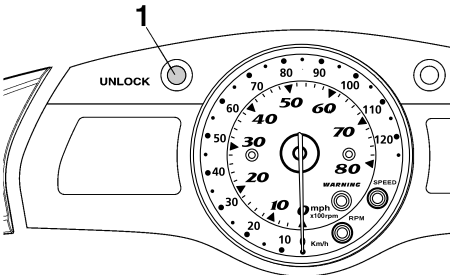

1 “UNLOCK” indicator light

EJU35010

“L-MODE” indicator light

The “L-MODE” indicator light comes on when the low-RPM mode is selected. (See page 41 for more information.)

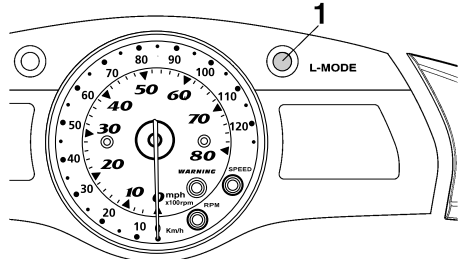

1 “L-MODE” indicator light

EJU35021

Left multifunction display and operation buttons

The left multifunction display is equipped with the following functions.

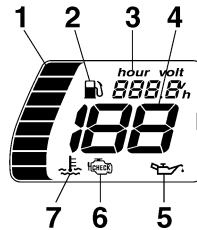

- 1 Fuel level meter
- 2 Fuel level warning indicator
- 3 Hour meter/voltmeter
- 4 Digital speedometer
- 5 Oil pressure warning indicator
- 6 Check engine warning indicator
- 7 Engine overheat warning indicator

Features and functions

The following operation buttons are on the left side of the multifunction information center.

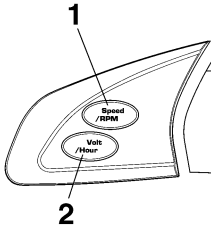

- 1 "Speed/RPM" button
- 2 "Volt/Hour" button

EJU37081

Digital speedometer

The digital speedometer shows the watercraft speed against water.

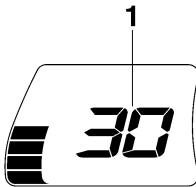

- 1 Digital speedometer

To switch the speedometer display between kilometers and miles, push the "Volt/Hour" button for at least 1 second, within 10 seconds after the multifunction information center starts operating.

The "SPEED" indicator light blinks three times if miles are selected as the display units when the multifunction information center starts operating, or if the display units are switched to miles.

TIP:

Kilometers are selected as the display units at the Yamaha factory.

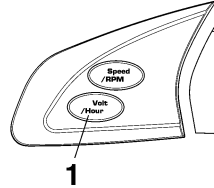

- 1 "Volt/Hour" button

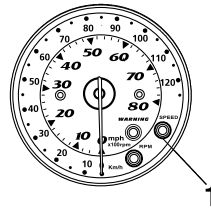

- 1 "SPEED" indicator light

EJU31512

Fuel level meter

The fuel level meter is provided for convenient fuel level checking while riding.

The fuel level meter has eight segments which show the amount of fuel remaining in the fuel tank. The display segments of the fuel

Features and functions

level meter disappear two at a time as the fuel level decreases.

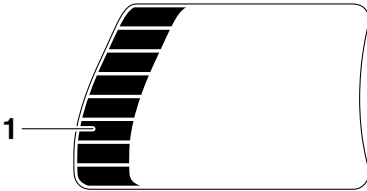

1 Fuel level meter

TIP:

The fuel level is most accurate when the watercraft is sitting level on a trailer or in the water.

EJU35061

Hour meter/voltmeter

To switch the display between the hour meter and the voltmeter, push the “Volt/Hour” button for at least 1 second after the meter is displayed for more than 10 seconds.

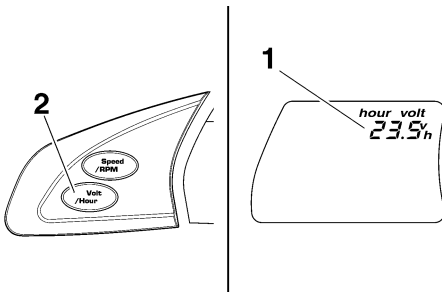

1 Hour meter/voltmeter

2 “Volt/Hour” button

Hour meter

The hour meter is provided to make it easy to follow the maintenance schedule.

The meter shows the hours of engine operation that have elapsed since the watercraft was new.

Voltmeter

The voltmeter is provided to display the voltage of the battery.

When the battery voltage is normal, the voltmeter displays approximately 12 volts.

If the battery voltage is less than 8.0 volts, “LO” is displayed on the voltmeter and if the voltage is above 18.1 volts, “HI” is displayed on the voltmeter. If “HI” or “LO” is displayed, return to shore and, if necessary, have a Yamaha dealer check the charging system and the battery.

EJU36811

Fuel level warning indicator

If the fuel remaining in the fuel tank drops to about 18 L (4.8 US gal, 4.0 Imp. gal), the lowest two fuel level segments, the fuel level warning indicator, and the “WARNING” indicator light begin to blink. The buzzer also starts sounding intermittently.

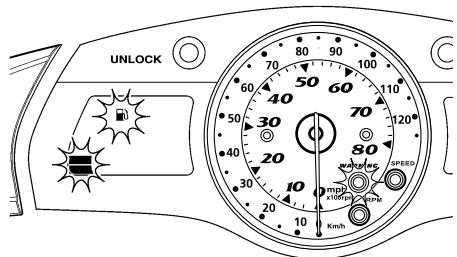

If this occurs, refill the fuel tank as soon as possible.

The warning signals will be cleared when the engine is restarted after the fuel tank is refilled.

TIP:

Press any button on the multifunction information center to stop the buzzer.

EJU35122

Oil pressure warning indicator

If the oil pressure does not rise to specification, the “WARNING” indicator light and the oil

Features and functions

pressure warning indicator begin to blink, and the buzzer sounds intermittently. At the same time, the engine speed is limited to help prevent damage.

sounds, the engine speed is limited to help prevent damage.

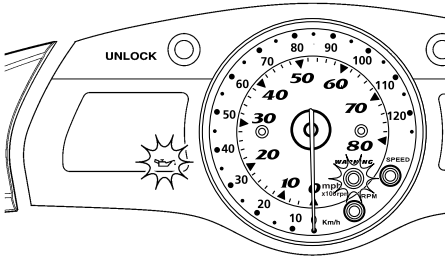

If this occurs, reduce the engine speed, return to shore, and then check the engine oil level. (See page 61 for engine oil level checking procedures.) If the oil level is low, add enough engine oil to raise it to the proper level. If the oil level is sufficient, have a Yamaha dealer check the watercraft.

TIP:

Press any button on the multifunction information center to stop the buzzer.

EJU36821

Engine overheat warning indicator

This model is equipped with an engine overheat warning system.

If the engine starts to overheat, the “WARNING” indicator light and the engine overheat warning indicator blink, and then come on. The buzzer also begins to sound intermittently, and then it sounds continuously. After the light and indicator start to blink and the buzzer

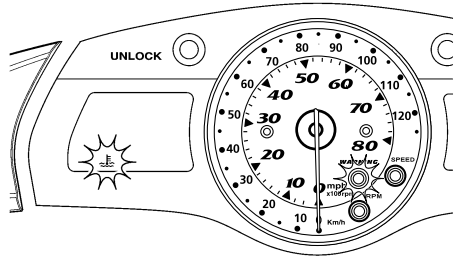

If this occurs, immediately reduce the engine speed, return to shore, and then check for water discharge at the port (left) cooling water pilot outlets while the engine is running. If there is no discharge of water, shut the engine off, and then check the intake grate and impeller for clogging. (See page 101 for more information.) **NOTICE: If you cannot locate and correct the cause of the overheating, consult a Yamaha dealer. Continuing to operate at higher speeds could result in severe engine damage.** [ECJ00041]

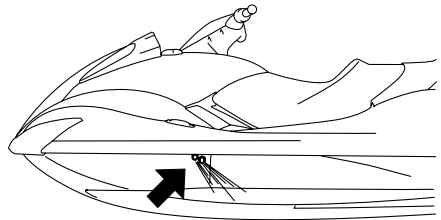

TIP:

Press any button on the multifunction information center to stop the buzzer.

EJU35131

Check engine warning indicator

If a sensor malfunction or a short circuit is detected, the “WARNING” indicator light and the

Features and functions

check engine warning indicator begin to blink, and the buzzer sounds intermittently.

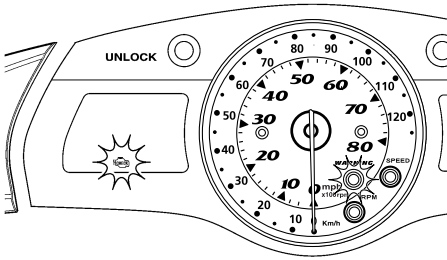

If this occurs, reduce the engine speed, return to shore, and have a Yamaha dealer check the engine.

TIP:

Press any button on the multifunction information center to stop the buzzer.

EJU35034

Right multifunction display and operation buttons (for FX Cruiser SHO)

The right multifunction display shows the following information.

- Compass
- Average speed
- Tripmeter
- Trip timer
- Fuel consumption per hour
- Fuel consumption per kilometer/mile
- Water temperature
- Air temperature

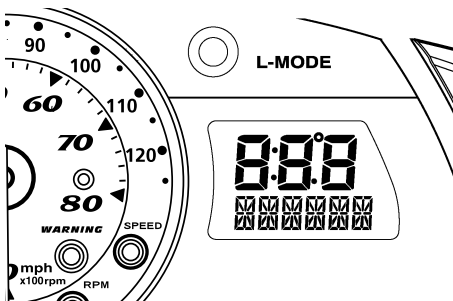

The following operation buttons are on the right side of the multifunction information center.

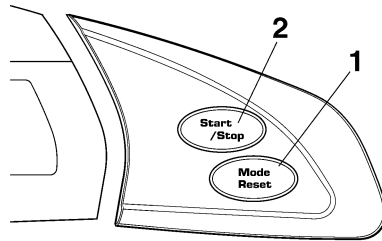

- 1 "Mode/Reset" button
- 2 "Start/Stop" button

To switch the display mode, push the "Mode/Reset" button for less than 1 second. The display mode changes in the following order.

Compass → Average speed → Tripmeter → Trip timer → Fuel consumption per hour → Fuel consumption per kilometer/mile → Water temperature → Air temperature

To switch the display units between kilometers/liters/degrees Celsius and miles/gallons/degrees Fahrenheit, push the "Volt/Hour" button for at least 1 second, within 10 seconds after the multifunction information center starts operating.

The "SPEED" indicator light blinks three times if miles/gallons/degrees Fahrenheit are selected as the display units when the multifunction information center starts operating, or if

Features and functions

the display units are switched to miles/gallons/degrees Fahrenheit.

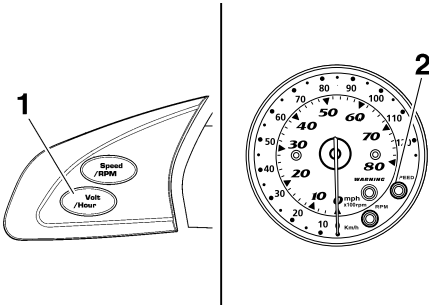

- 1 "Volt/Hour" button
- 2 "SPEED" indicator light

Compass

This display shows the current direction of the watercraft using the 8 major compass points.

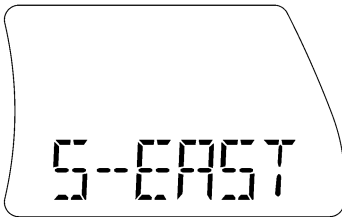

TIP:

The accuracy of the compass varies depending on the operating conditions. Use this function as a reference only.

Average speed

This display shows the average speed in miles per hour "AV MPH" or kilometers per hour "AV KMH" since it was reset.

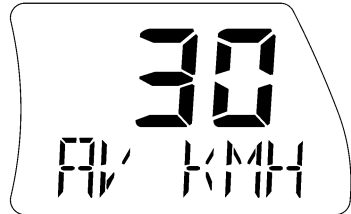

Tripmeter

This display shows the distance traveled in miles "MILES" or kilometers "KM" since it was reset.

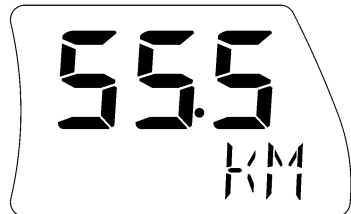

Trip timer

This display shows the hours of operation "TRIP TM" since it was reset.



Features and functions

Fuel consumption per hour

This display shows the current fuel consumption in gallons per hour “G/HR” or liters per hour “L/HR”.



Water temperature

This display shows the ambient water temperature “L TEMP” (lake temperature).

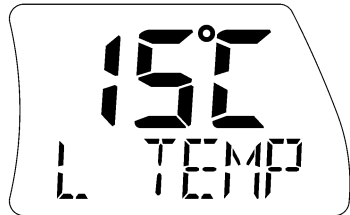

Fuel consumption per kilometer/mile

This display shows the current fuel consumption in gallons per mile “G/MILE” or liters per kilometer “L/KM”.

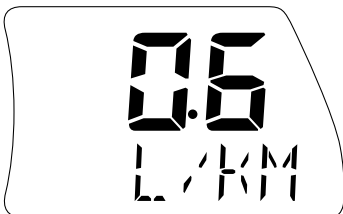

Air temperature

This display shows the ambient air temperature “E TEMP” (environmental temperature).

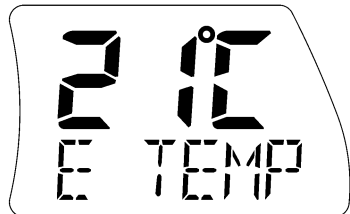

TIP:

The actual fuel consumption varies depending on the operating conditions. Use this function as a reference only.

Average speed/Tripmeter/Trip timer modes

Average speed, distance traveled, and trip time are recorded once measurements have started, regardless of the current display.

To start the measurements, push the “Start/Stop” button for less than 1 second. The beeper sounds once.

To stop the measurements, push the “Start/Stop” button for less than 1 second. The beeper sounds once. To restart the measurements, push the “Start/Stop” button for less than 1 second. The beeper sounds once.

To reset the displays, push the “Mode/Reset” button for at least 2 seconds while the mea-

Features and functions

measurements are stopped. The beeper sounds twice.

To open the front storage compartment, pull the visor up, and then lift the hood.

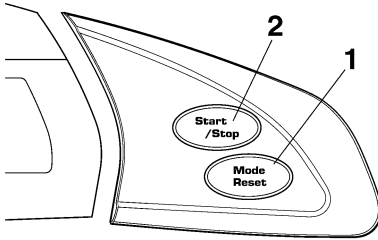

- 1 "Mode/Reset" button
- 2 "Start/Stop" button

The displays can be reset only when the measurements are stopped.

The measurements are not saved if the engine is stopped. The displays are reset automatically when they go off 25 seconds after the engine stops.

EJU35142

Storage compartments

A front storage compartment, glove compartment, seat storage compartment, watertight compartment, and beverage holder are provided.

Only the securely closed watertight compartment is waterproof. If you carry objects that must be kept dry, such as the manuals, put them in a waterproof bag or in the watertight compartment.

Make sure that the storage compartments are closed securely before operating the watercraft.

EJU36832

Front storage compartment

The front storage compartment is located at the bow.

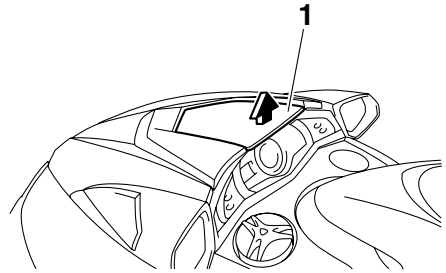

- 1 Visor

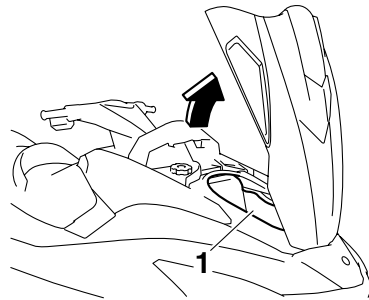

- 1 Front storage compartment

Front storage compartment:

Capacity:

66.0 L (17.4 US gal, 14.5 Imp.gal)

Load limit:

5.0 kg (11 lb)

Features and functions

To close the front storage compartment, push down on the center of the hood until it latches securely.

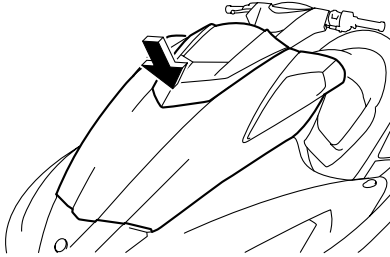

EJU35161

Glove compartment

The glove compartment is located in front of the seat.

To open the glove compartment, turn the glove compartment knob, and then lift up the lid.

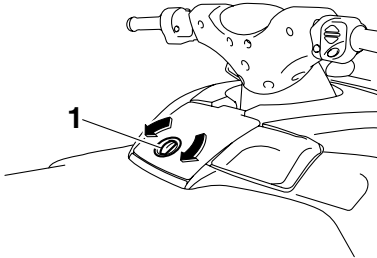

1 Glove compartment knob

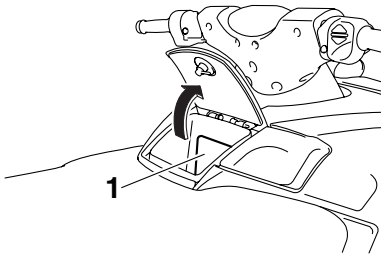

1 Glove compartment

Glove compartment:

Capacity:

5.9 L (1.6 US gal, 1.3 Imp.gal)

Load limit:

1.0 kg (2 lb)

To close the glove compartment, lower the lid, and then turn the glove compartment knob to lock the lid in place.

EJU31760

Seat storage compartment

The seat storage compartment is located under the rear seat.

To open the seat storage compartment, remove the rear seat. (See page 30 for rear seat removal and installation procedures.)

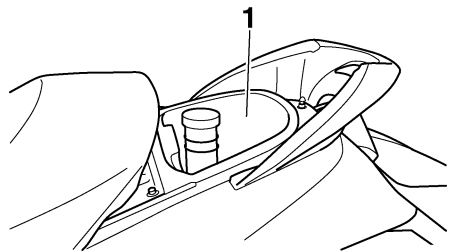
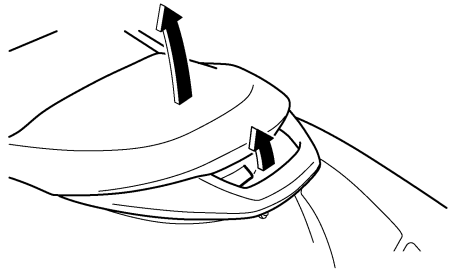

1 Seat storage compartment

Seat storage compartment:

Capacity:

15.0 L (4.0 US gal, 3.3 Imp.gal)

Load limit:

9.0 kg (20 lb)

EJU35171

Beverage holder

The beverage holder is located on the starboard (right) side of the watercraft.

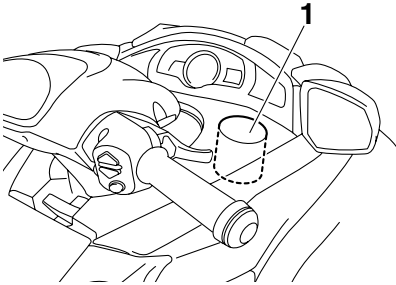

1 Beverage holder

Do not place beverages in the beverage holder when operating the watercraft.

EJU35184

Watertight compartment

The watertight compartment is located on the port (left) side of the watercraft.

To open the watertight compartment, turn the cap counterclockwise.

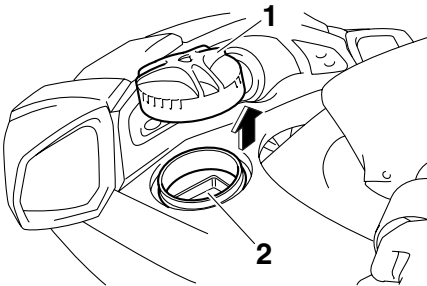

1 Watertight compartment cap

2 Watertight compartment

Watertight compartment:

Capacity:

2.7 L (0.7 US gal, 0.6 Imp. gal)

Load limit:

1.0 kg (2.2 lb)

To close the watertight compartment, turn the cap clockwise until it stops.

Operation

EJU31821

Fuel and oil

EJU37222

Fuel

EWJ00282

WARNING

- **Gasoline and gasoline vapors are extremely flammable. To avoid fires and explosions and to reduce the risk of injury when refueling, follow these instructions.**
- **Gasoline is poisonous and can cause injury or death. Handle gasoline with care. Never siphon gasoline by mouth. If you should swallow some gasoline, inhale a lot of gasoline vapor, or get some gasoline in your eyes, see your doctor immediately. If gasoline spills on your skin, wash with soap and water. If gasoline spills on your clothing, change your clothes.**

ECJ00321

NOTICE

- **Do not use leaded gasoline. Leaded gasoline can seriously damage the engine.**
- **Avoid getting water and contaminants in the fuel tank. Contaminated fuel can cause poor performance and engine damage. Use only fresh gasoline that has been stored in clean containers.**

Recommended fuel:

Regular unleaded gasoline with a minimum octane rating of

86

(Pump octane number) = $(R + M)/2$

90 (Research octane number)

fuel meets the minimum octane ratings. E-85 is a fuel blend containing 85% ethanol and therefore must not be used in this watercraft. All ethanol blends containing more than 10% ethanol can cause fuel system damage or engine performance problems.

Yamaha does not recommend gasohol containing methanol because it can cause fuel system damage and engine performance problems.

To fill the fuel tank:

- (1) Before refueling, turn off the engine. Do not stand or sit on the watercraft. Never refuel while smoking, or while in the vicinity of sparks, open flames, or other sources of ignition.
- (2) Place the watercraft in a well-ventilated area and in a horizontal position.
- (3) Remove the seats, and then check the fuel level. (See page 30 for seat removal and installation procedures.)
- (4) Open the hood. (See page 31 for hood opening and closing procedures.)
- (5) Remove the fuel tank filler cap, and then slowly add fuel to the fuel tank. Stop filling when the fuel level reaches approximately 50 mm (2 in) from the top of the fuel tank. Do not overfill the fuel tank. Because fuel expands when it heats up, heat from the engine or the sun can cause fuel to spill out of the fuel tank. Do not leave the watercraft with a full tank in direct sunlight.

Gasohol

There are two types of gasohol: gasohol containing ethanol and that containing methanol. Gasohol containing ethanol can be used if ethanol content does not exceed 10% and the

Fuel tank capacity:
70 L (18.5 US gal, 15.4 Imp.gal)



1 Approximately 50 mm (2 in) from top of the fuel tank

- (6) Wipe up any spilled fuel immediately.
- (7) Install the fuel tank filler cap, and then close the hood. Make sure that the fuel tank filler cap and the hood are securely closed before operating the watercraft.
- (8) Install the seats. Make sure that the seats are securely installed before operating the watercraft.

EJU31891

Engine oil

ECJ00281

NOTICE

Use only 4-stroke engine oil. Usage of 2-stroke engine oil could result in severe engine damage.

Make sure that the engine oil is at the specified level. Add oil as necessary. (See page 61 for engine oil level checking procedures.) Use a combination of the recommended SAE and API engine oil classifications shown in the chart below.

SAE								API
-4	14	32	50	68	86	104	122	F
-20	-10	0	10	20	30	40	50	C
10W-30								SE SF SG SH SJ SL
10W-40								
						20W-40		
						20W-50		

Operation

EJU31980

Pre-operation checks

EJU31991

Pre-operation check list

Before operating this watercraft, perform the checks in the following check list.

EWJ00411



Failure to inspect or maintain the watercraft properly increases the possibility of an accident or damage to the watercraft. Do not operate the watercraft if you find any problem. If a problem cannot be corrected by the procedures provided in this manual, have the watercraft inspected by a Yamaha dealer.

ITEM	ROUTINE	PAGE
BEFORE LAUNCH OR OPERATION		
Engine compartment	Remove the seats to ventilate the engine compartment. Check for fuel vapors and loose electrical connections.	61
Bilge	Check for water and fuel and drain if necessary.	63
Stern drain plugs	Check for proper installation.	63
Throttle lever	Check that the throttle lever springs back smoothly.	64
Steering system	Check for proper operation. Check that the handlebars are locked in place.	65
Shift lever and reverse gate	Check for proper operation.	65
QSTS	Check for proper operation.	66
Fuel and oil	Check the fuel and oil levels and replenish if necessary. Check the hoses and tanks for leakage.	61, 61
Water separator	Check for water and drain if necessary.	62
Battery	Check the electrolyte level and battery condition.	63
Hood	Check that the hood is securely closed.	31
Front and rear seats	Check that the seats are securely installed.	30
Hull and deck	Check the hull and deck for cracks and other damage.	61
Jet intake	Check for debris and remove if necessary.	67
Fire extinguisher	Check the condition and replace if necessary.	64
Engine shut-off cord (lanyard)	Check the condition and replace if frayed or broken.	67
Switches	Check the start switch, engine stop switch, and engine shut-off switch for proper operation.	67
AFTER LAUNCH		
Cooling water pilot outlet	Check that water is discharged while the engine is running and the watercraft is in the water.	68
Multifunction information center	Check for warning indications and proper operation.	68

TIP:

Pre-operation checks should be made each time the watercraft is used. These checks can be completed in a short time. It is worth the time spent to ensure safety and reliability.

Operation

EJU32280

Pre-operation check points

EJU32331

Engine compartment

EWJ00460

WARNING

Failure to ventilate the engine compartment could result in a fire or explosion. Do not start the engine if there is a fuel leak or a loose electrical connection.

Ventilate the engine compartment before each use.

To ventilate the engine compartment, remove the seats. (See page 30 for seat removal and installation procedures.) Leave the engine compartment open for a few minutes to allow any fuel vapors to escape.

While the engine compartment is open, check for loose electrical connections.

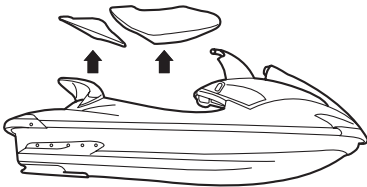

EJU32350

Hull and deck

Check the hull and deck for cracks and other damage. If any damage is found, have a Yamaha dealer repair the watercraft.

EJU36871

Fuel level

Make sure that there is sufficient fuel in the fuel tank before each use.

Also, check the fuel system for leakage, cracks, and malfunctions. (See page 89 for check points and correct procedures.)

- (1) Open the hood and remove the fuel tank filler cap to release any pressure that

might have built up in the fuel tank. (See page 31 for hood opening and closing procedures.)

- (2) Remove the seats. (See page 30 for seat removal and installation procedures.)
- (3) Check the fuel level in the fuel tank and replenish if necessary. (See page 57 for filling procedures.)
- (4) Install the fuel tank filler cap, and then close the hood and install the seats.

EJU36882

Engine oil level

Check the engine oil level before each use.

EWJ00340

WARNING

Engine oil is extremely hot immediately after the engine is turned off. Coming in contact with or getting any engine oil on your clothes could result in burns.

ECJ01001

NOTICE

Make sure that debris and water do not enter the oil filler hole. Debris and water in the engine oil can cause serious engine damage.

To check the engine oil level:

- (1) Place the watercraft in a precisely level position on land with the engine stopped.

TIP:

If the engine was running, allow the engine oil to settle by waiting 5 minutes or more before checking the oil level.

- (2) Remove the seats. (See page 30 for seat removal and installation procedures.)
- (3) Remove the dipstick, wipe it clean, and then insert it back into the dipstick tube completely. Remove the dipstick again and check that the engine oil level is be-

tween the minimum and maximum level marks.

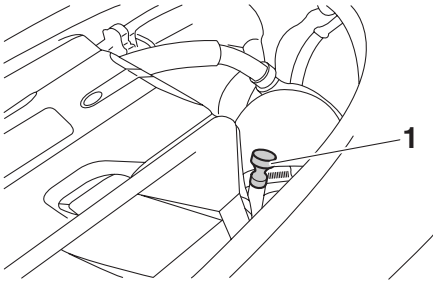

1 Dipstick

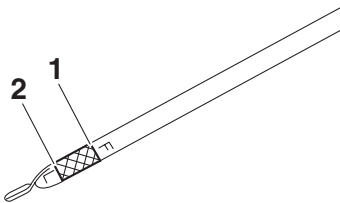

1 Maximum level mark

2 Minimum level mark

- (4) If the engine oil level is below the minimum level mark, perform steps 5–7 to add enough oil so that the oil level is between the minimum and maximum level marks on the dipstick. If the engine oil level is significantly above the maximum level mark, have a Yamaha dealer service the watercraft.

- (5) Remove the engine oil filler cap.

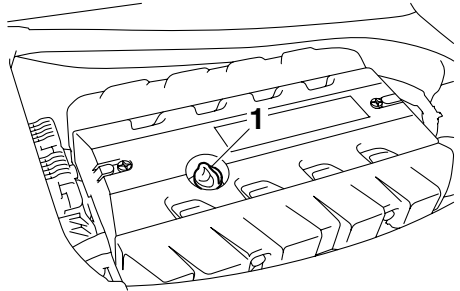

1 Engine oil filler cap

- (6) Pour engine oil into the filler hole. Wait approximately 5 minutes until the engine oil settles.

TIP:

The difference between the minimum and maximum level marks on the dipstick is equal to approximately 1 liter of engine oil.

- (7) Repeat steps 3–6 until the engine oil is at the proper level.
(8) Install the engine oil filler cap, and then install the seats.

EJU32420

Water separator

Check the water separator for water. The water separator retains any water that may have entered through the fuel tank breather hose if the watercraft was capsized. Normally, the water separator is empty.

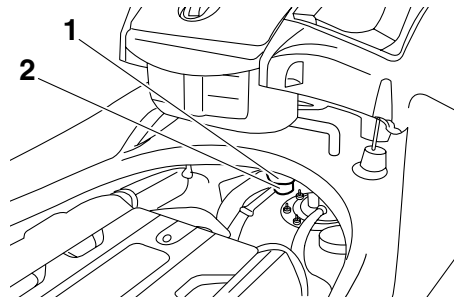

1 Water separator

2 Drain screw

Operation

If water remains in the water separator, drain it by removing the drain screw. Place a drain pan under the water separator to catch the draining water or use a dry cloth to soak up any water that could spill into the watercraft. If any water spills into the watercraft, be sure to wipe it up with a dry cloth. Also, be sure to install the drain screw after draining the water separator.

EJU32452

Bilge

Check the bilge for moisture and fuel residue.

NOTICE: Excessive water in the engine compartment can splash into the engine, which can result in severe damage. [ECJ00341]

This watercraft is equipped with a conventional jet vacuum bilge draining system and an electric bilge draining system. The electric bilge draining system is operated when the engine is running. When excess water reaches the water inlet of the electric bilge pump, the water is discharged from the electric bilge pilot outlet at the stern.

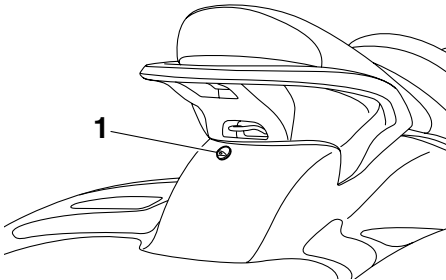

1 Electric bilge pilot outlet

A small quantity of water will remain in the bilge and should be drained manually. To drain any residual water, beach the watercraft and perform the following procedure.

To drain water from the bilge:

- (1) Remove the stern drain plugs.
- (2) Raise the bow of the watercraft until the water drains.

- (3) After the water has drained, wipe the bilge with dry rags to make sure that it is thoroughly dry.

- (4) Install the stern drain plugs. **NOTICE: Before installing the stern drain plugs, clean the drain plug threads to remove any foreign materials, such as dirt or sand. Otherwise, the stern drain plugs could be damaged, allowing water to enter the engine compartment. Make sure that the stern drain plugs are tightened securely before launching the watercraft. Otherwise, water may flood the engine compartment and cause the watercraft to submerge.**

[ECJ00361]

EJU32472

Stern drain plugs

Check the stern drain plugs for proper installation.

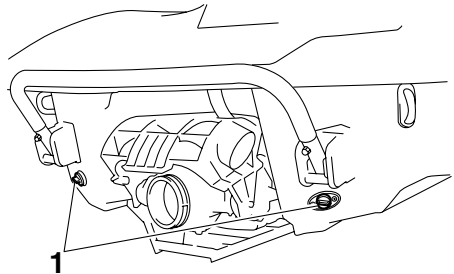

1 Stern drain plugs

EJU32482

Battery

Check the battery electrolyte level and check that the battery has sufficient power to start the engine easily. **WARNING! Never operate the watercraft if the battery does not have sufficient power to start the engine or if it shows any other signs of decreased power. Loss of battery power may leave you stranded.** [EWJ01240]

Recharge the battery or replace it if it is not in good condition. (See page 95 for battery recharging procedures.)

Also, check that the battery leads are tightened securely and that there is no corrosion on the battery terminals. Check that the breather hose is securely connected to the battery and that it is not pinched. **WARNING! Fire or explosion could result if the breather hose is damaged, obstructed, or not connected properly.** [EJWJ00451]

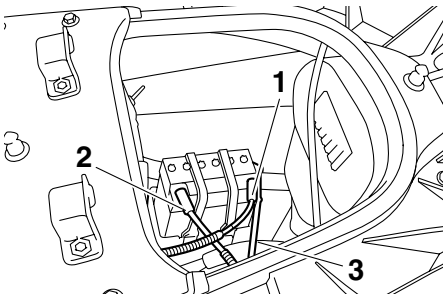

- 1 Positive (+) battery terminal: Red lead
- 2 Negative (-) battery terminal: Black lead
- 3 Breather hose

Make sure that the battery is securely held in place.

EJU32571

Fire extinguisher

Check that there is a full fire extinguisher on board.

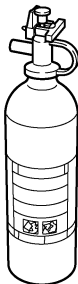

The fire extinguisher container is located in the seat storage compartment.

To open the fire extinguisher container, turn the cap counterclockwise.

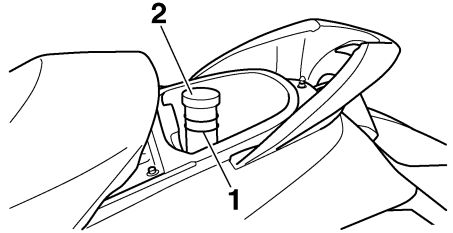

- 1 Fire extinguisher container
- 2 Fire extinguisher container cap

To close the fire extinguisher container, insert the fire extinguisher into the container, and then install the cap and tighten it securely.

To check the fire extinguisher, see the instructions supplied by the fire extinguisher manufacturer. Always keep the fire extinguisher in the fire extinguisher container.

Always carry a fire extinguisher on board. A fire extinguisher is not standard equipment with this watercraft. If you do not have one, contact a Yamaha dealer or a fire extinguisher dealer to obtain one meeting the proper specifications.

Fire extinguisher: Classification: B-1 Capacity: 2 lb or more

EJU32591

Throttle lever

Check the throttle lever for proper operation. Squeeze and release the throttle lever several times to make sure that there is no hesitation in its travel. It should be smooth over the com-

Operation

plete range and spring back to the idle position when released.

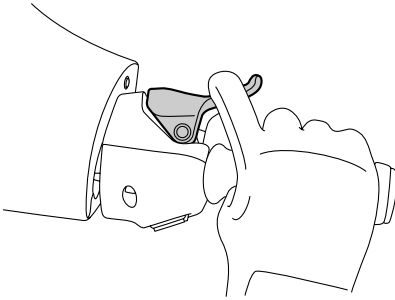

EJU32611

Steering system

Check the handlebars for looseness.

Turn the handlebars as far as possible to the right and left to make sure that operation is smooth and unrestricted throughout the whole range. Also, make sure that the jet thrust nozzle moves as the handlebars are turned, and that there is no free play between the handlebars and the jet thrust nozzle.

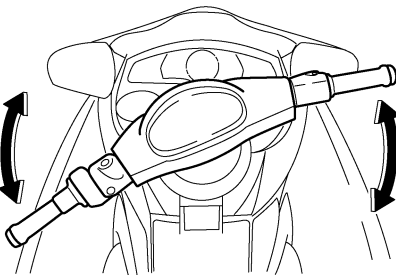

Push the handlebars back and forth to check that the tilt lever and handlebars are locked in

place. (See "Tilt lever" on page 35 for more information.)

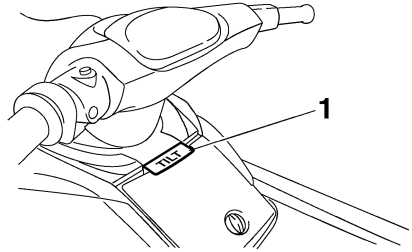

1 Tilt lever

EJU36581

Shift lever and reverse gate

EWJ00031

WARNING

Do not touch the reverse gate while the shift lever is being operated, otherwise you could be pinched.

Check the shift lever and reverse gate for proper operation.

Make sure that the reverse gate goes down completely when the shift lever is pulled up.

Also, make sure that the reverse gate goes up completely when the shift lever is pushed down.

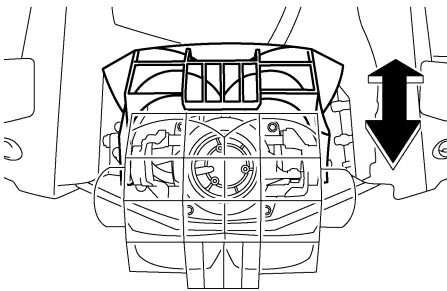
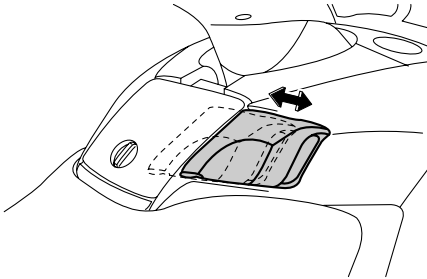

EJU32641

Quick Shift Trim System (QSTS)

Operate the QSTS selector lock lever and the QSTS selector several times to check that they operate properly.

- (1) Squeeze the QSTS selector lock lever and check that it returns smoothly to its original position when released.

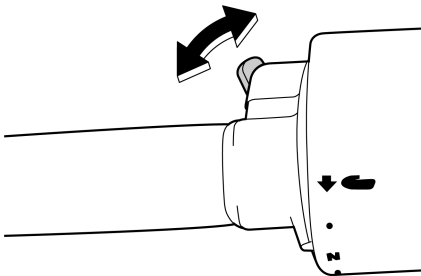

- (2) Check that the QSTS selector turns smoothly when the lever is squeezed and check that the selector locks in place at each position when the lever is released.

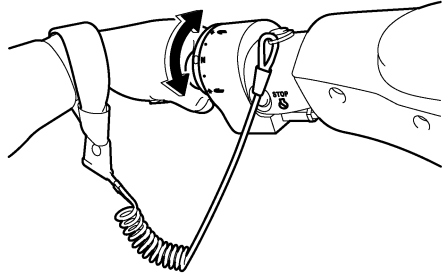

- (3) Check that the angle of the jet thrust nozzle changes when the QSTS selector is shifted from neutral to bow up or bow down.

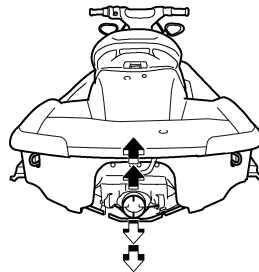
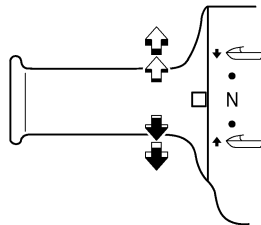

If the mechanism does not work properly, have a Yamaha dealer service it.

Operation

EJU32651

Jet intake

Carefully check the jet intake for weeds, debris, or anything else that might restrict the intake of water. If the jet intake is clogged, clean it. (See page 101 for jet intake cleaning procedures.)

If the watercraft is operated while the jet intake is clogged, cavitation could occur, reducing jet thrust, and possibly damaging the jet pump. In some cases, the engine may overheat because of lack of cooling water, and damage to the engine could result. Cooling water is fed to the engine by the jet pump.

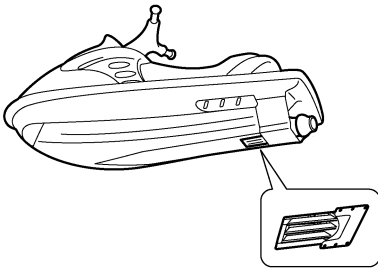

EJU32661

Engine shut-off cord (lanyard)

Check that the engine shut-off cord (lanyard) is not frayed or broken. If the cord is damaged, replace it. **WARNING! Never try to repair the engine shut-off cord (lanyard) or tie it together. The engine shut-off cord (lanyard) may not pull free when the operator falls off, allowing the watercraft to**

continue to run and cause an accident.

[EWJ01220]

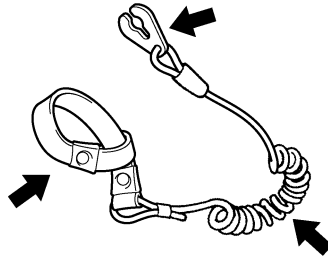

EJU32671

Switches

ECJ00410

NOTICE

Do not run the engine for more than 15 seconds when checking the switches on land without supplying water, otherwise the engine could overheat.

Check the start switch, the engine stop switch, and the engine shut-off switch for proper operation.

Push the start switch to start the engine. As soon as the engine starts running, push the engine stop switch to verify that the engine stops immediately. Restart the engine, and then pull the engine shut-off cord (lanyard) to remove the clip from the engine shut-off switch to verify that the engine stops immediately. (See pages 33 to 33 for information on proper operation of the start switch, the en-

gine stop switch, and the engine shut-off switch.)

operation of the multifunction information center.)

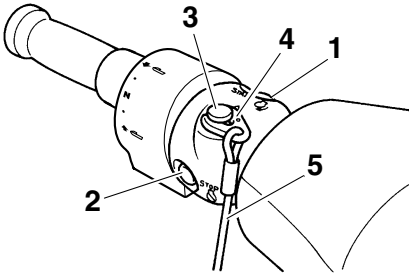

- 1 Start switch
- 2 Engine stop switch
- 3 Engine shut-off switch
- 4 Clip
- 5 Engine shut-off cord (lanyard)



EJU36890

Cooling water pilot outlets

Check that water comes out from the port (left) cooling water pilot outlets while the engine is running and the watercraft is in the water. (See page 34 for more information.)

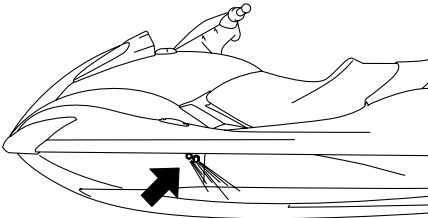

EJU32711

Multifunction information center

Check the multifunction information center for proper operation while the watercraft is in the water. (See page 44 for information on proper

Operation

EJU32742

Operation

EWJ00510

WARNING

Before operating your watercraft, become familiar with all of the controls. Consult a Yamaha dealer about any control or function that you do not fully understand. Failure to understand how the controls work could cause an accident or prevent you from avoiding an accident.

ECJ00460

NOTICE

Make sure that the stern drain plugs are tightened securely before launching the watercraft.

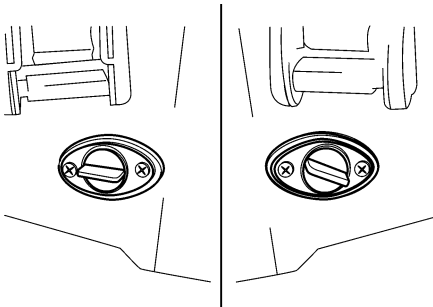

EJU36661

Engine break-in

ECJ00430

NOTICE

Failure to follow the engine break-in procedure could result in reduced engine life or even severe engine damage.

The engine break-in period is essential to allow the various components of the engine to wear and polish themselves to the correct operating clearances. This ensures proper performance and promotes longer component life.

TIP:

Be sure to check the engine oil level before operating the watercraft for the first time. (See page 61 for engine oil checking procedures.)

- (1) Launch the watercraft and start the engine. (See page 69 for engine starting procedures.)
- (2) For the first 5 minutes, run the engine at trolling speed only. For the 30 minutes of operation after that, keep the engine speed below 5000 r/min. For the 1 hour of operation after that, keep the engine speed below 6000 r/min.
- (3) Proceed with normal operation.

EJU32801

Launching the watercraft

When launching the watercraft, make sure that there are no obstacles behind you.

Use the remote control transmitter to select the unlock mode. (See page 40 for Yamaha Security System lock and unlock mode selection procedures.)

After the watercraft is in the water, start the engine. Shift into reverse and move the watercraft back slowly. If there are waves, someone should make sure that the watercraft is not pushed into the trailer before backing away.

EJU36341

Starting the engine

- (1) If the lock mode of the Yamaha Security System is selected, use the remote control transmitter to select the unlock mode. (See page 40 for Yamaha Security System lock and unlock mode selection procedures.)
- (2) Launch the watercraft in water free from weeds and debris and at least 60 cm (2 ft) deep from the bottom of the watercraft.
NOTICE: Never operate in water that is less than 60 cm (2 ft) deep from the bottom of the watercraft, otherwise

pebbles or sand could be sucked into the jet intake, causing impeller damage and engine overheating. [ECJ00471]

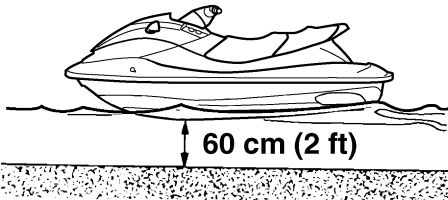

- (3) Attach the engine shut-off cord (lanyard) to your left wrist, and then attach the clip to the engine shut-off switch. It is not possible to start the engine with the clip removed from the engine shut-off switch. **WARNING! Check that the engine shut-off cord (lanyard) is attached correctly. If the engine shut-off cord (lanyard) is not attached correctly, it may not pull free when the operator falls off, allowing the watercraft to continue to run and cause an accident.** [EWJ00581]

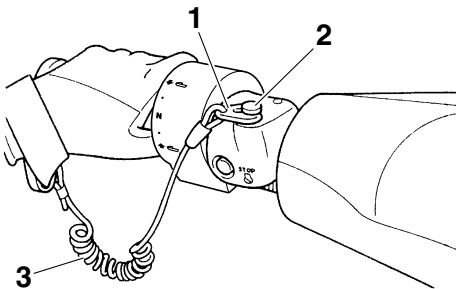

- 1 Clip
- 2 Engine shut-off switch
- 3 Engine shut-off cord (lanyard)

- (4) Push the start switch (green button), and then release it as soon as the engine starts to run. If the engine does not start

in 5 seconds, release the start switch, wait 15 seconds, and then try again. The engine will not start if the throttle lever is squeezed. **NOTICE: Never push the start switch while the engine is running. Do not operate the start switch for more than 5 seconds, otherwise the battery will be discharged and the engine will not start. Also, the starter motor could be damaged.** [ECJ01040]

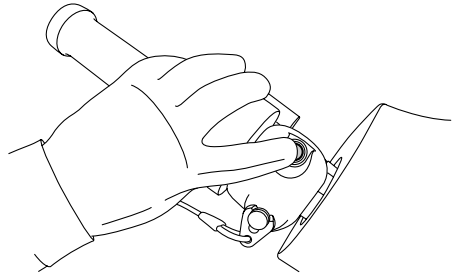

EJU32861

Stopping the engine

To stop the engine, release the throttle lever, and then push the engine stop switch (red button). **WARNING! You need throttle to steer. Shutting the engine off can cause you to hit an obstacle you are attempting to avoid. A collision could result in severe injury or death.** [EWJ00601]

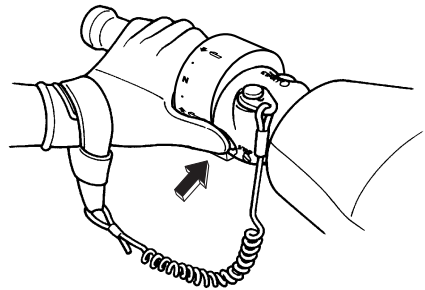

Operation

EJU37181

Shifting

EWJ01230

WARNING

- Do not use the reverse function to slow down or stop the watercraft as it could cause you to lose control, be ejected, or impact the handlebars.
- Make sure that there are no obstacles or people behind you before shifting into reverse.
- Do not touch the reverse gate while the shift lever is being operated, otherwise you could be pinched.

To shift into reverse:

- (1) Release the throttle lever and let the engine speed return to idle.
- (2) Pull the shift lever toward you.

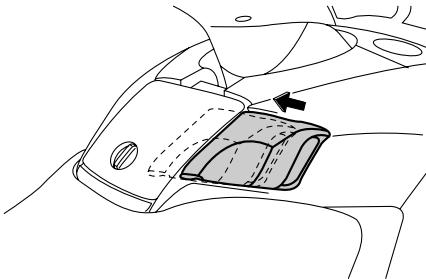

To shift into forward:

- (1) Release the throttle lever and let the engine speed return to idle.

- (2) Push the shift lever away from you.

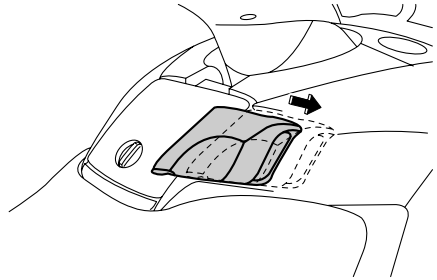

EJU32882

Leaving the watercraft

If leaving the watercraft, select the lock mode of the Yamaha Security System and remove the engine shut-off cord (lanyard) to reduce the chance of accidental starting or unauthorized use by children or others. (See page 40 for Yamaha Security System lock and unlock mode selection procedures.)

EJU32901

Operating your watercraft

EJU32952

Getting to know your watercraft

Operating your watercraft requires skills acquired through practice over a period of time. Take the time to learn the basic techniques well before attempting more difficult maneuvers.

Operating your new watercraft can be a very enjoyable activity, providing you with hours of pleasure. However, it is essential to familiarize yourself with the operation of the watercraft to achieve the skill level necessary to enjoy riding safely.

Before operating this watercraft, read this owner's/operator's manual, the Riding Practice Guide, the Riding Instruction card, and all labels on the watercraft. Pay particular attention to the safety information on page 10. Also, watch the Basic Orientation Video provided with your watercraft. These materials should give you an understanding of the watercraft and its operation.

Remember: This watercraft is designed to carry the operator and up to 2 passengers. Never exceed the maximum load limit or allow more than 3 persons (or 2 persons if a water-skier is being pulled) to ride the watercraft at any time.

Maximum load:
240 kg (530 lb)
Load is the total weight of cargo, operator, and passengers.

EJU32991

Learning to operate your watercraft

Before operating the watercraft, always perform the pre-operation checks listed on page 59. The short time spent checking the watercraft will reward you with added safety and reliability.

Check state and local laws before operating your watercraft.

Operate defensively at safe speeds and keep a safe distance away from people, objects, and other watercraft. Select a wide area to learn in, where there is good visibility and light boat traffic.

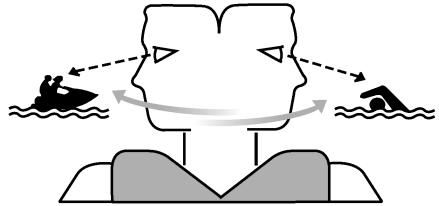

Use the buddy system—operate with someone nearby. Scan constantly for people, objects, and other watercraft. Be alert for conditions that limit your visibility or block your vision of others.

Attach the engine shut-off cord (lanyard) to your left wrist and keep it free from the handlebars so that the engine stops if you, the operator, fall off.

Wear a personal flotation device (PFD). All riders must wear a U.S. Coast Guard approved PFD that is suitable for personal watercraft use.

Wear protective clothing. Severe internal injuries can occur if water is forced into body cavities as a result of falling into the water or being near the jet thrust nozzle. Normal swimwear does not adequately protect against forceful water entry into the rectum and vagina. All riders must wear a wetsuit bottom or clothing that provides equivalent protection.

Such clothing includes thick, tightly woven, sturdy and snug-fitting apparel such as denim, but does not include spandex or similar

Operation

fabrics, like those used in bicycle shorts. A full wetsuit can also protect against hypothermia (subnormal body temperature) and abrasions.

Footwear and gloves are recommended.

Eye protection is recommended to keep wind, water, and glare from the sun out of your eyes while you operate your watercraft. Restraining straps for eyewear are made which are designed to float should your eyewear fall in the water.

You should grip the handlebars firmly and keep both feet on the floor of the footwell. Do not attempt to ride with passengers until your operating skills are fully developed.

EJU33051

Riding with passengers

EWJ00541

WARNING

- **Do not apply throttle when anyone is at the rear of the watercraft. Turn the engine off or keep it at idle. Water and debris exiting the jet thrust nozzle can cause severe injury. Passengers should not attempt to board the watercraft if the operator is applying throttle.**
- **When passengers are on board, make sure that they are holding on firmly and have their feet on the floor of the footwell before you start to accelerate.**

When 2 or 3 persons (including the operator) are on board, the watercraft handles differently, and is not as easy to maneuver, therefore operating it requires a higher degree of skill. Before attempting to operate the watercraft with passengers on board, the operator must practice operating the watercraft alone enough to be able to acquire the necessary skills.

The passengers must always wear a U.S. Coast Guard approved PFD and a wetsuit bottom or equivalent.

Do not give a ride to children whose feet cannot reach the floor of the footwell. The passengers should hold on firmly, either to the person in front of them or to the handgrip provided, and keep their feet on the floor of the footwell. Never allow a passenger to ride in front of the operator.

When pulling a water-skier, the spotter should face to the rear while holding the handgrip with both hands. The spotter should always sit astride the seat with both feet placed firmly on the floor of the footwell for proper balance. Follow state laws regarding water-skiing, such as those for skier-down flags, rearward-facing spotter, and other requirements.

EJU33081

Starting the watercraft

EWJ00711

WARNING

To avoid collisions:

- **Scan constantly for people, objects, and other watercraft. Be alert for conditions that limit your visibility or block your vision of others.**
- **Operate defensively at safe speeds and keep a safe distance away from people, objects, and other watercraft.**
- **Do not follow directly behind watercraft or other boats. Do not go near others to spray or splash them with water. Avoid sharp turns or other maneuvers that make it hard for others to avoid you or understand where you are going. Avoid areas with submerged objects or shallow water.**
- **Take early action to avoid collisions. Remember, watercraft and other boats do not have brakes. Do not release the**

throttle lever when trying to steer away from objects—you need throttle to steer.

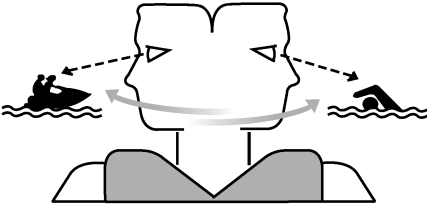

start the engine, and then look in all directions before starting off.

EJU33111

Boarding and starting from a dock

- (1) Board the watercraft from the side.
- (2) Attach the engine shut-off cord (lanyard) to your left wrist, and then attach the clip to the engine shut-off switch.
- (3) Push the watercraft away from the dock, grip the handlebars with both hands, place both feet on the floor of the footwell, start the engine, and then look in all directions before starting off.

EJU33092

Boarding and starting in shallow water

- (1) Launch the watercraft in water free from weeds and debris and at least 60 cm (2 ft) deep from the bottom of the watercraft.
- NOTICE:** Never operate in water that is less than 60 cm (2 ft) deep from the bottom of the watercraft, otherwise pebbles or sand could be sucked into the jet intake, causing impeller damage and engine overheating. [ECJ00471]

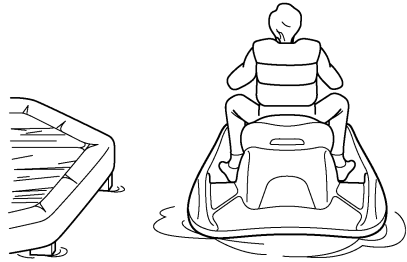

EJU36081

Boarding and starting in deep water

EWJ01111

WARNING

Be sure the operator and any passengers have practiced boarding from the water while still close to shore before riding. A person who has made many unsuccessful attempts to get back on the watercraft may become fatigued and suffer from exposure, increasing the risk of injury and drowning.

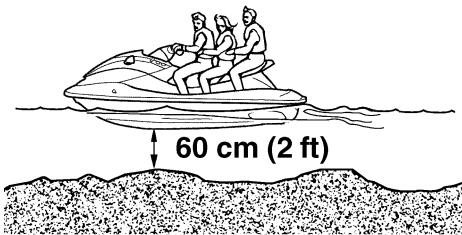

- (2) Board the watercraft from the side or the rear.
- (3) Attach the engine shut-off cord (lanyard) to your left wrist, and then attach the clip to the engine shut-off switch.
- (4) Grip the handlebars with both hands, place both feet on the floor of the footwell,

Boarding in deep water requires more skill. The operator and passengers should practice boarding in shallow water before riding in deep water.

Operation

EJU36351

Boarding alone

- (1) Swim to the rear of the watercraft and place both hands on the boarding platform, pull yourself up, and then grasp the handgrip with one hand.

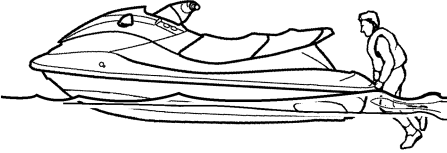

- (2) Pull yourself up to a kneeling position on the platform, and then move to the seat and sit astride.

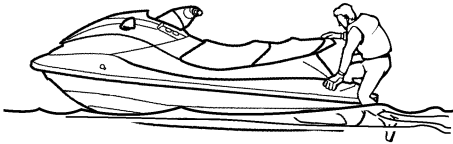

- (3) Attach the engine shut-off cord (lanyard) to your left wrist, and then attach the clip to the engine shut-off switch.
- (4) Grip the handlebars with both hands, place both feet on the floor of the footwell,

start the engine, and then look in all directions before starting off.



TIP:

This watercraft is equipped with a reboarding step, which you can lower to make reboarding easier. The step returns automatically to the up position after you have boarded.

EJU33164

Boarding with passengers

EWJ00660

WARNING

Severe internal injuries can occur if water is forced into body cavities as a result of being near the jet thrust nozzle. Do not apply throttle until the passengers are seated with their feet on the floor of the footwell and are securely holding on to the person in front of them or to the handgrip provided.

TIP:

The heavier the total weight of the operator and passengers, the more difficult it will be to balance the watercraft. Do not operate the watercraft when the total weight exceeds 240 kg (530 lb) including any cargo.

- (1) Climb on board as noted in the previous section, and sit astride the seat.

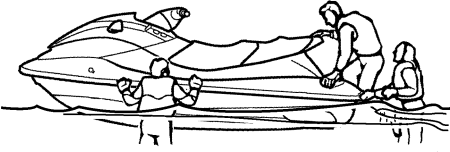

both the passengers and the operator should try to balance the watercraft.



- (2) Attach the engine shut-off cord (lanyard) to your left wrist, and then attach the clip to the engine shut-off switch.
- (3) Have the passengers move to the rear of the watercraft.

- (5) Check that the passengers have their feet on the floor of the footwell and are securely holding on to the person in front of them or to the handgrip provided. Never allow a passenger to ride in front of the operator.

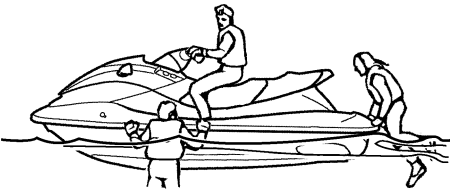

- (4) Have a passenger board and sit astride the seat. If a second passenger is boarding, have him or her follow the same procedure. When a passenger is boarding,

- (6) Start the engine, look in all directions, and then accelerate to planing speed.

To board when it is difficult to balance the watercraft at a standstill:

- (1) While the passengers are steadying the watercraft, pull yourself up onto the boarding platform into a kneeling posi-

Operation

tion, and then move to the seat and sit astride to balance the watercraft.

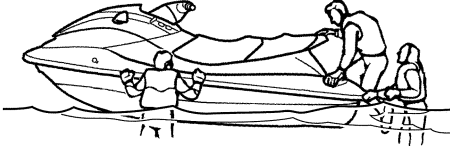

- (2) Have a passenger pull him or herself up onto the boarding platform into a kneeling position, then move to the seat and sit astride to balance the watercraft.
- (3) Attach the engine shut-off cord (lanyard) to your left wrist, and then attach the clip to the engine shut-off switch.
- (4) Start the engine and keep it at idle.
- (5) Have the second passenger pull him or herself up onto the boarding platform into a kneeling position, then crawl onto the seat as the watercraft accelerates.



- (6) Gradually increase the speed to balance the watercraft.



EJU33231

Capsized watercraft

EWJ00671

WARNING

Improper uprighting can cause injury.

- **Be sure to shut the engine off by pulling on the engine shut-off cord (lanyard) to remove the clip from the engine shut-off switch.**
- **Do not put your hands in the intake grate.**

If the watercraft capsizes, turn it over immediately.

Be sure to carefully follow the procedures below to prevent injury, or damage to the watercraft.

- (1) Remove the clip from the engine shut-off switch.
- (2) Swim to the rear of the watercraft. Pull the watercraft over with your left hand on the ride plate while pushing down on the gunwale with your right hand or foot.

If the port (left) side of the capsized watercraft is tilting up, push down on the gunwale so that the port (left) side is down before turning the watercraft clockwise. **NOTICE: Do not turn the watercraft over counterclockwise, otherwise water can enter the engine,**

which can result in severe damage.

[ECJ00541]

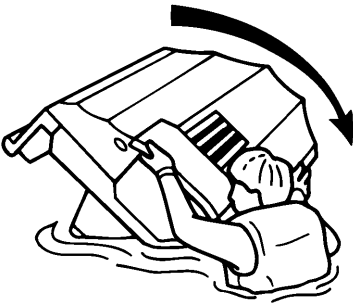
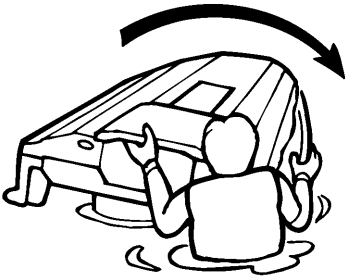

- (3) Start the engine and operate the watercraft as straight as possible and above planing speed for at least 2 minutes to discharge any water remaining in the engine compartment. (If the engine does not start, see “Towing the watercraft” on page 104 or “Submerged watercraft” on page 104.) **NOTICE: Do not operate the engine at full throttle for at least 1 minute after the engine has been restarted. Excessive water in the engine compartment can splash into the engine, which can result in severe damage.** [ECJ00551]

EJU33251

Turning the watercraft

EWJ00770



WARNING

- Do not release the throttle lever when trying to steer away from objects—you

need throttle to steer. A collision could result in severe injury or death.

- When operating at higher speeds, make gradual turns or slow down before turning. Sharp high-speed turns may cause the watercraft to slide sideways or spin, throwing the operator and passengers overboard, which could cause an injury.

Steering control depends on the combination of handlebar position and the amount of throttle.

Water sucked in through the intake grate is pressurized by the impeller in the jet pump. As the pressurized water is expelled from the pump through the jet thrust nozzle, it creates thrust to move and steer the watercraft. The higher the engine speed, the more thrust produced.

The amount of jet thrust, in addition to the position of the handlebars, determines how sharply you turn.

- A. More throttle produces higher thrust, so the watercraft will turn more sharply.

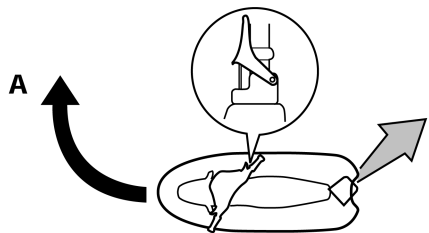

Operation

B. Less throttle produces lower thrust, so the watercraft will turn more gradually.

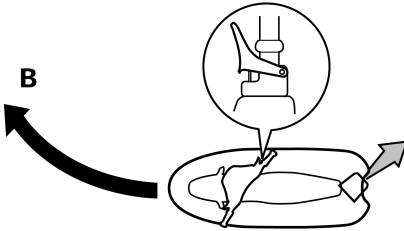

D. If the engine is stopped while riding, there is no thrust. The watercraft will go straight even though the handlebars are turned.

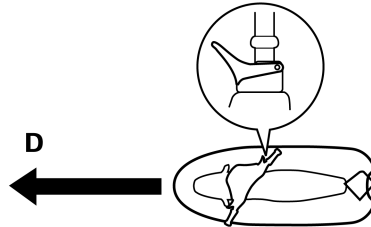

C. Releasing the throttle lever completely produces only minimum thrust. If you are traveling at speeds above trolling, you will have rapidly decreasing ability to steer without throttle. You may still have some turning ability immediately after releasing the throttle lever, but once the engine slows down, the watercraft will no longer respond to handlebar input until you apply throttle again or you reach trolling speed.

At trolling speed, the watercraft can be turned gradually by handlebar position alone using just the amount of thrust available at idle.

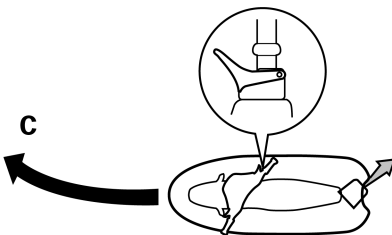

You need throttle to steer.

This model is equipped with the Yamaha Engine Management System (YEMS) that includes an off-throttle steering (OTS) system. It will activate at planing speeds should you attempt to steer the watercraft after releasing the throttle lever (see condition C above).

The OTS system assists in turning by continuing to supply some thrust while the watercraft is decelerating, but you can turn more sharply if you apply throttle while turning the handlebars. The OTS system does not function below planing speeds or when the engine is off. Once the engine slows down, the watercraft will no longer turn in response to handlebar input until you apply throttle again or you reach trolling speed.

EJU33290

Stopping the watercraft

The watercraft is not equipped with a separate braking system. It is stopped by water resistance when the throttle lever is released. From full speed, the watercraft comes to a complete stop in approximately 100 m (330 ft) after the throttle lever is released or the engine is stopped, although this distance will vary depending on many factors, including gross weight, water surface conditions, and wind direction. The watercraft slows down as

soon as the throttle lever is released, but will coast for a distance before fully stopping. If you are not sure you can stop in time before hitting an obstacle, apply throttle and turn in another direction.

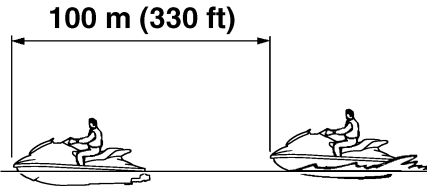

EWJ00740

WARNING

- Allow adequate stopping distance.
- Take early action to avoid collisions. Remember, watercraft and other boats do not have brakes.
- Operate defensively at safe speeds and keep a safe distance away from people, objects, and other watercraft to give you time to stop.
- Do not shut the engine off when slowing down in case you need engine power to steer away from a boat or other obstacle that comes into your path.
- Do not use the reverse function to slow down or stop the watercraft as it could cause you to lose control, be ejected, or impact the handlebars.

EJU35961

Beaching the watercraft

- (1) Make sure that there are no boats, swimmers, or obstacles near the beach. Release the throttle lever about 100 m (330 ft) before you reach the intended beaching area.

- (2) Approach the beach slowly and stop the engine before reaching land. Remember, you need throttle to steer.
- (3) Get off the watercraft and pull it up on the beach. **NOTICE: Small pebbles, sand, seaweed, and other debris can be sucked into the jet intake and impair or damage the impeller. Always stop the engine and get off the watercraft before beaching it.** [ECJ00491]

EJU36060

Docking the watercraft

- (1) Make sure that there are no boats, swimmers, or obstacles near the watercraft. Reduce speed about 100 m (330 ft) away from the dock.
- (2) Slowly approach the dock and stop the engine just before coming alongside it.

EJU36671

Reverse on waterways

Reverse can be used for slow-speed maneuvering when it is necessary to back up out of tight spots where you cannot turn around. Once the engine is idling, shift into reverse and gradually increase engine speed. Make sure that there are no obstacles or people behind you before shifting into reverse.

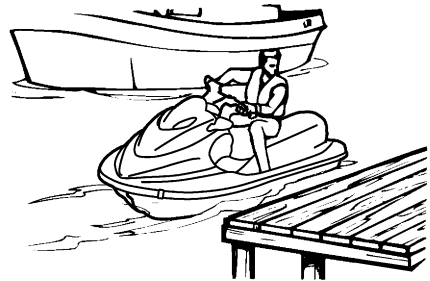

TIP:

This model is equipped with a function which limits the engine speed in reverse.

Operation

EJU37190

Operating in weeded areas

Always avoid operating your watercraft in areas where weed growth is thick. If traveling in weeded areas is unavoidable, operate the engine alternately at partial throttle and full throttle. Weeds tend to accumulate more at a steady speed and at trolling speed. If weeds clog the intake area and cause cavitation, clean the jet intake and impeller. (See page 101 for cleaning procedures.)

EJU37141

Post-operation care

To keep your watercraft in top shape, always take it out of the water after using it and perform the following procedures. Leaving the watercraft in the water for extended periods will accelerate the rate of normal deterioration of the jet unit components and hull finish. Marine organisms and corrosion are some of the conditions that can adversely affect the life of many watercraft components.

- (1) Remove the watercraft from the water.
- (2) Wash down the hull, handlebars, and jet unit with fresh water.
- (3) Remove the seats and check the engine compartment for water. To drain excess water, remove the stern drain plugs, and then raise the bow of the watercraft enough to allow the water in the bilge to drain out.

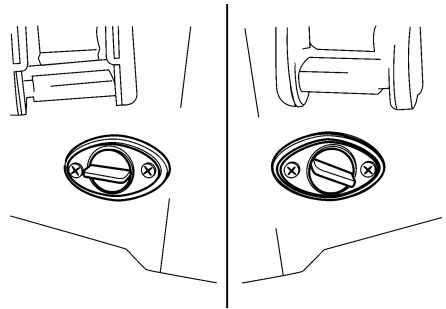

TIP:

This watercraft is equipped with a jet vacuum bilge draining system and an electric bilge draining system that remove water from the engine compartment while you are underway. However, some residual water will remain, therefore remove the stern drain plugs to drain the water. (See page 63 for bilge draining procedures.)

- (4) Place the watercraft in a horizontal position.

- (5) Flush the cooling system to prevent it from clogging with salt, sand, or dirt. (See page 83 for flushing procedures.)
- (6) Rinse the engine and engine compartment with a small amount of water.
NOTICE: Do not use high-pressure water when rinsing the engine or engine compartment as severe engine damage could result. [ECJ00571]
- (7) Wipe the engine and engine compartment dry with a clean cloth (repeat step 3, if necessary).
- (8) Wipe the hull, handlebars, and jet unit dry with a clean cloth.
- (9) Spray a rust inhibitor, such as Yamaha Silicone Protectant and Lubricant, on metallic parts to minimize corrosion.
- (10) Allow the engine compartment to air dry completely before installing the seats.

EJU33462

Transporting

Before putting the watercraft on a trailer or transporting it, be sure to put the shift lever in the forward position. When transporting the watercraft on a trailer, secure the tie downs to the trailer through the bow eye and stern eyes. **NOTICE: Do not attach ropes or tie downs to any part of the watercraft other than the bow eye and stern eyes to secure the watercraft to the trailer. Otherwise, the watercraft may be damaged. Wrap the ropes or tie downs with towels or rags where they touch the body of the watercraft to avoid scratches or damage. Do not transport the watercraft with the shift lever in the reverse position. Otherwise, the reverse gate may hit an obstacle, which could cause damage.** [ECJ00642]

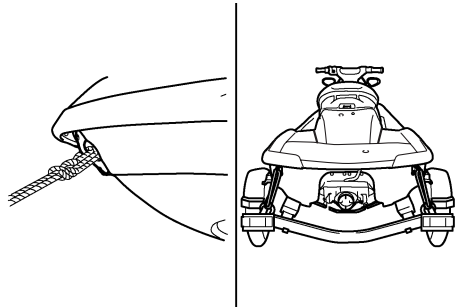

Maintenance and care

EJU33490

Storage

EWJ00330

WARNING

Always place the watercraft upright in a horizontal position when storing it, otherwise fuel could leak out into the engine or engine compartment, which could create a fire hazard.

Storage for long periods of time, such as winter storage, requires preventive maintenance to ensure against deterioration. It is advisable to have the watercraft serviced by a Yamaha dealer prior to storage. However, the following procedures can be performed by the owner.

EJU33534

Flushing the cooling system

Flushing the cooling system is essential to prevent it from clogging with salt, sand, or dirt.

- (1) Place the watercraft in a horizontal position.
- (2) Remove the rear seat and seat storage compartment. (See page 30 for seat removal and installation procedures.)
- (3) Remove the flushing hose connector cap, and then insert the garden hose adapter into the flushing hose connector and turn it until it is securely connected.

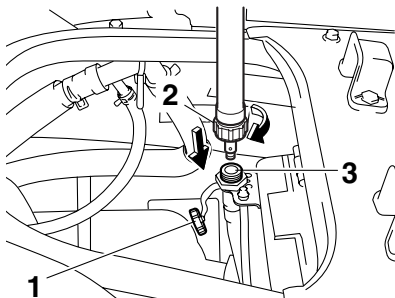

- 1 Flushing hose connector cap
- 2 Garden hose adapter
- 3 Flushing hose connector

- (4) Connect the garden hose adapter to a water tap using a garden hose.

TIP:

A garden hose is not included.

- (5) Start the engine, and then immediately turn the water supply on until water flows out continually from the jet thrust nozzle.

NOTICE: Do not run the engine for more than 15 seconds without supplying water or over 4000 r/min on land, otherwise the engine could overheat.

[ECJ01050]

TIP:

If you will be storing the watercraft for a prolonged period, such as winter storage, top off the fuel tank with fresh gasoline and add one ounce of Yamaha Fuel Stabilizer and Conditioner to each gallon of fuel in the fuel tank before starting the engine.

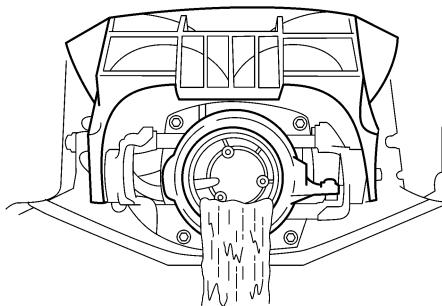

- (6) Run the engine at idling speed for about 3 minutes watching the engine condition. If the engine stops while flushing, turn the water supply off immediately and repeat the above steps. **NOTICE: Do not supply water to the cooling water passages when the engine is not running. The water could flow back through the muffler into the engine, causing severe engine damage.** [ECJ00122]
- (7) Turn the water supply off, and then force the remaining water out of the cooling

water passages by alternately squeezing and releasing the throttle lever for 10 to 15 seconds.

- (8) Stop the engine.
- (9) Remove the garden hose adapter and install the flushing hose connector cap.
- (10) Install the seat storage compartment and the rear seat.

EJU36902

Lubrication

- (1) Lubricate all cables such as the throttle and steering cables.

Use a Yamaha Power Cable Luber and Yamaha Lube-Zall to pressure-lubricate the cables and purge out any moisture between the inner and outer cables.

- (2) Lubricate the areas of the watercraft specified in "Lubrication points" on page 93.

EJU33681

Battery

If the watercraft will not be used for more than a month, remove the battery from the watercraft and store it in a cool, dry place.

- (1) Disconnect the negative (–) battery lead first, then the positive (+) battery lead and breather hose, and then remove the battery from the watercraft.
- (2) Clean the battery casing using fresh water.
- (3) If the battery terminals are dirty or corroded, clean them with a wire brush.
- (4) Fully charge the battery.
- (5) Apply Yamaha Marine Grease or Yamaha Grease A to the battery terminals, and then store the battery in a cool, dry place.
- (6) Check the battery at least once every 2 months and fully charge it if necessary.

NOTICE: Always keep the battery charged. Storing a discharged battery

can cause permanent battery damage.

[ECJ00101]

To check the condition of the battery, check the specific gravity of the electrolyte or measure the voltage at both battery terminals. Charge the battery if the voltage is less than 12 volts.

Specific gravity (for reference): 1.28 at 20 °C (68 °F)
--

It is recommended to have a Yamaha dealer check the specific gravity and charge the battery. If you maintain the battery yourself, be sure to read and follow the instructions provided with the battery tester and charger you use.

EJU33741

Cleaning the watercraft

Clean the watercraft before storing it for a long period.

- (1) Wash down the hull, handlebars, and jet unit with fresh water.
- (2) Rinse the engine and engine compartment with fresh water. Drain all of the water and wipe up any remaining moisture with clean, dry rags. **NOTICE: Do not use high-pressure water when rinsing the engine and engine compartment as severe engine damage could result.**

[ECJ00111]

- (3) Spray the engine's exterior with a rust inhibitor and lubricant such as Yamaha Silicone Protectant and Lubricant.
- (4) Wax the hull with a non-abrasive wax such as Yamaha Silicone Wax.
- (5) Wipe all vinyl and rubber components, such as the seat and engine compartment seals, with a vinyl protectant such as Yamaha Protectant.

Maintenance and care

EJU33752

Maintenance and adjustments

Periodic inspection, adjustment, and lubrication will keep your watercraft in the safest and most efficient condition possible. Safety is an obligation of the watercraft owner. Proper maintenance must be carried out to keep the exhaust emission and sound levels within the regulated limits. The most important points of watercraft inspection, adjustment, and lubrication are explained on the following pages.

See a Yamaha dealer for genuine Yamaha replacement parts and optional accessories designed for your watercraft.

Remember, failures that are the result of the installation of parts or accessories which are not qualitatively equivalent to genuine Yamaha parts are not covered by the limited warranty.

Maintenance, replacement, or repair of the emission control devices and system may be performed by any marine SI engine repair establishment or individual. Warranty repair, however, must be performed at an authorized Yamaha marine dealership.

EWJ00311

WARNING

Be sure to turn off the engine when you perform maintenance unless otherwise specified. If you are not familiar with machine servicing, this work should be done by a Yamaha dealer or other qualified mechanic.

A service manual is available for purchase through a Yamaha dealer for owners who have the mechanical skills, tools, and other equipment necessary to perform maintenance not covered by this owner's/operator's manual.

EJU33801

Owner's/operator's manual and tool kit

It is advisable to always carry the owner's/operator's manual and tool kit with you whenever you use the watercraft. For your convenience, a storage compartment is provided on the watercraft for the manual and tool kit.

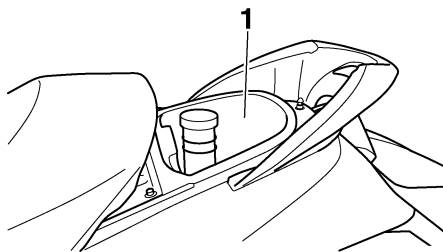

1 Storage compartment

To protect these materials from water damage, it would be a good idea to put them in a waterproof bag. If your owner's/operator's manual is damaged, order a replacement from a Yamaha dealer.

The service information included in this manual is intended to provide you, the owner, with the necessary information for completing your own preventive maintenance and minor repairs. The tools provided in the tool kit are sufficient for this purpose, except that a torque

Maintenance and care

wrench may also be necessary to tighten nuts and bolts.

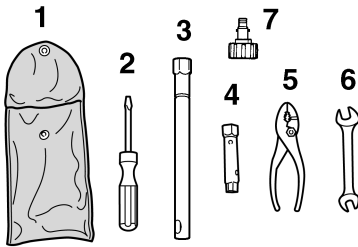

- 1 Tool bag
- 2 Screwdriver
- 3 16 mm box wrench
- 4 10/12 mm box wrench
- 5 Pliers
- 6 Open-end wrench
- 7 Garden hose adapter

Maintenance and care

EJU37060

Periodic maintenance chart

The following chart gives general guidelines for periodic maintenance. However, maintenance may need to be performed more frequently depending on your operating conditions.

This “●” mark indicates maintenance that you may do yourself.

This “○” mark indicates work to be done by a Yamaha dealer.

Item	Operation	Initial			Thereafter every		Page
		10 hours	50 hours	100 hours	100 hours	200 hours	
			6 months	12 months	12 months	24 months	
Spark plugs	Check, clean, adjust	●/○		●/○	●/○		92
Lubrication points	Lubricate			●/○	●/○		93
Internal engine components	Lubricate	○*2 50 hours or 12 months					—
QSTS cables	Lubricate			○	○		—
Intermediate housing	Lubricate	○		●/○	●/○		93
Fuel system	Check			○	○		89
Fuel tank	Check, clean			●/○	●/○		89
Trolling speed	Check, adjust			●/○	●/○		96
Throttle shaft	Check			○	○		—
Cooling water passages	Flush	●*1					83
Water inlet strainer	Check, clean			○	○		—
Bilge strainer	Clean			○	○		—
Electric bilge pump strainer	Check, clean			○	○		—
Impeller	Check			○	○		—
Jet thrust nozzle angle	Check, adjust			●/○	●/○		89
Steering master	Check	○		○	○		—
QSTS mechanism	Check, adjust	○		○	○		—
Shift cable and reverse gate	Check, adjust			●/○	●/○		90
Throttle cable	Check, adjust	○		●/○	●/○		90
Stern drain plugs	Check, replace			○	○		63

Maintenance and care

Item	Operation	Initial			Thereafter every		Page
		10 hours	50 hours	100 hours	100 hours	200 hours	
			6 months	12 months	12 months	24 months	
Battery	Check, charge			●/○	●/○		95
Rubber coupling	Check					○	—
Engine mount	Check					○	—
Nuts and bolts	Check	○		○	○		—
Air filter element	Check			○	○		89
Engine oil	Replace	○	○ 50 hours or 12 months				89
Oil filter	Replace			○	○		89
Valve clearance	Check, adjust					○	—

*1 This operation should be performed after every use.

*2 This operation should be performed before long-term storage.

Maintenance and care

EJU34212

Checking the fuel system

EWJ00381

WARNING

Leaking fuel can result in fire or explosion.

- Check for fuel leakage regularly.
- If any fuel leakage is found, the fuel system must be repaired by a qualified mechanic. Improper repairs can make the watercraft unsafe to operate.

Check the fuel system for leaks, cracks, and malfunctions. If any problem is found, consult a Yamaha dealer.

Check:

- Fuel tank filler cap and seal for damage
- Fuel in fuel tank for water and dirt
- Fuel tank for damage, cracks, and leakage
- Fuel hoses and joints for damage, cracks, and leakage
- Air bleeding passages for leakage

EJU34230

Fuel tank

Check the fuel tank for leakage and for water in the tank. If water is found in the fuel system, or if the fuel tank needs to be cleaned, have a Yamaha dealer service the watercraft.

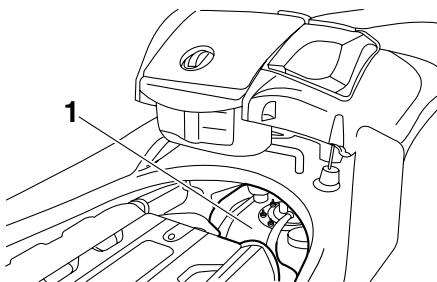

1 Fuel tank

EJU36941

Engine oil and oil filter

EWJ00340

WARNING

Engine oil is extremely hot immediately after the engine is turned off. Coming in contact with or getting any engine oil on your clothes could result in burns.

ECJ00991

NOTICE

Do not run the engine with too much or not enough oil in the engine, otherwise the engine could be damaged.

It is recommended to have a Yamaha dealer change the engine oil. However, if you choose to change the oil on your own, refer to the service manual for this watercraft.

Recommended engine oil:
SAE 10W-30, 10W-40, 20W-40, 20W-50
Oil grade:
API SE, SF, SG, SH, SJ, SL
Oil quantity:
With oil filter replacement:
3.1 L (3.28 US qt, 2.73 Imp.qt)
Without oil filter replacement:
3.0 L (3.17 US qt, 2.64 Imp.qt)
Total amount:
4.3 L (4.55 US qt, 3.78 Imp.qt)

EJU34311

Air filter element

Have a Yamaha dealer check the air filter element at the intervals specified in the periodic maintenance chart.

EJU34321

Checking the jet thrust nozzle angle

Check the handlebars and jet thrust nozzle for smooth operation.

Turn the handlebars as far as possible to the right and left and check that the difference of distances A and B between the jet thrust nozzle and the nozzle is within specification.

Difference of A and B:
Maximum 5 mm (0.20 in)

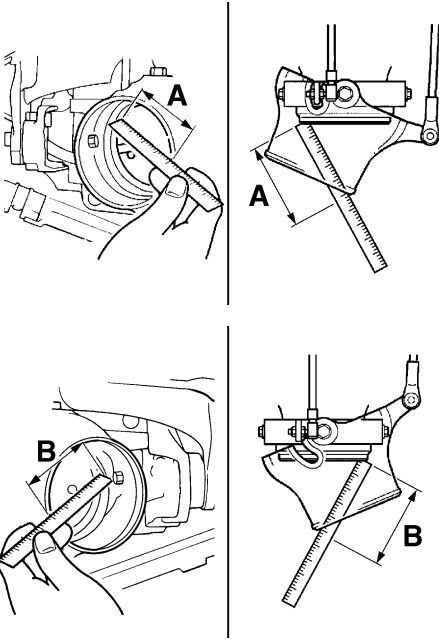

If the steering is stiff or misadjusted, have a Yamaha dealer service it.

EJU36590

Checking the shift cable

Place the shift lever in the reverse position. Make sure that the reverse gate makes contact with the stopper.

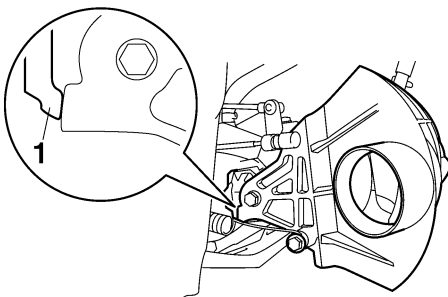

1 Stopper

If the reverse gate does not make contact with the stopper, have a Yamaha dealer service it.

EJU37030

Checking and adjusting the throttle cable

Face the handlebars straight ahead, and then check that the throttle cable moves back to the set position smoothly and that the throttle lever free play is within specification.

Squeeze and release the throttle lever. If the throttle lever does not return smoothly, have a Yamaha dealer service it.

If the specified throttle lever free play cannot be obtained as described below, have a Yamaha dealer make the adjustment.

FX SHO

- (1) Remove the eight screws, and then remove the front handlebar cover.

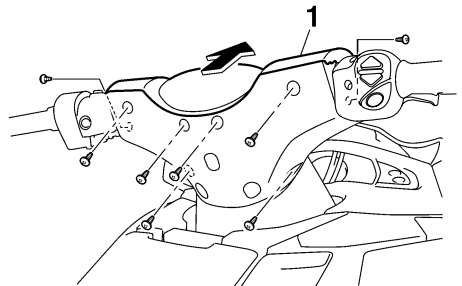

1 Front handlebar cover

- (2) Slide the rubber cover away from the adjuster, and then loosen the locknut.

Maintenance and care

- (3) Make sure that the handlebars are facing straight ahead, and then adjust the free play by turning the adjuster.

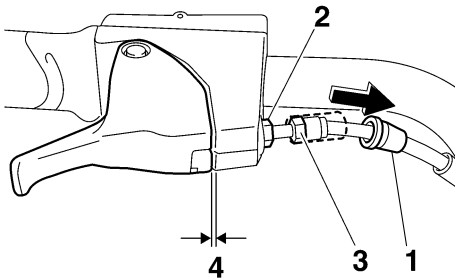

- 1 Rubber cover
- 2 Locknut
- 3 Adjuster
- 4 Throttle lever free play

Throttle lever free play:
2.0–5.0 mm (0.08–0.20 in)

- (4) Hold the adjuster with one wrench while tightening the locknut with another wrench. Slide the rubber cover to its original position.
- (5) Install the front handlebar cover, and then install the eight screws.

FX Cruiser SHO

- (1) Remove the ten screws, and then remove the front and rear handlebar covers.

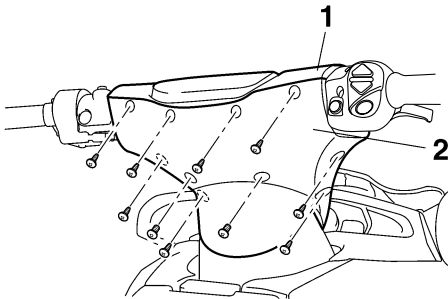

- 1 Front handlebar cover
- 2 Rear handlebar cover

- (2) Slide the rubber cover away from the adjuster, and then loosen the locknut.
- (3) Make sure that the handlebars are facing straight ahead, and then adjust the free play by turning the adjuster.

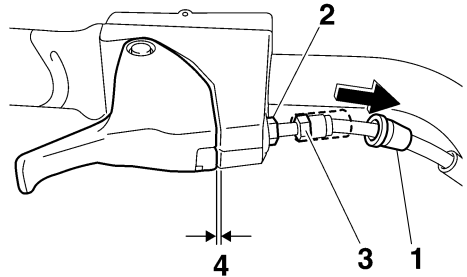

- 1 Rubber cover
- 2 Locknut
- 3 Adjuster
- 4 Throttle lever free play

Throttle lever free play:
2.0–5.0 mm (0.08–0.20 in)

- (4) Hold the adjuster with one wrench while tightening the locknut with another wrench. Slide the rubber cover to its original position.

Maintenance and care

- (5) Install the front and rear handlebar covers as shown in the illustration, and then install the ten screws.

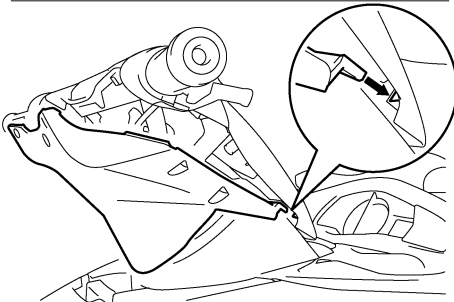
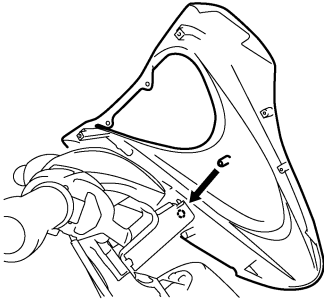

EJU37041

Cleaning and adjusting the spark plugs

EWJ00350

WARNING

Be careful not to damage the insulator when removing or installing a spark plug. A damaged insulator could allow sparks to escape, which could result in a fire or explosion.

The spark plug is an important engine component and is easy to inspect. The condition of the spark plug can indicate something about the condition of the engine. For example, if one spark plug has a distinctly different color, the engine could require servicing. Do not attempt to diagnose any problems yourself. Have a Yamaha dealer service the watercraft.

Remove and inspect the spark plugs periodically; heat and deposits will cause the spark plugs to slowly break down and erode. If electrode erosion becomes excessive, or if carbon and other deposits are excessive, replace the spark plug with the specified plug.

Specified spark plug:
LFR6A

To remove a spark plug:

- (1) Remove the seats. (See page 30 for seat removal and installation procedures.)
- (2) Remove the engine cover screws, and then remove the engine cover.

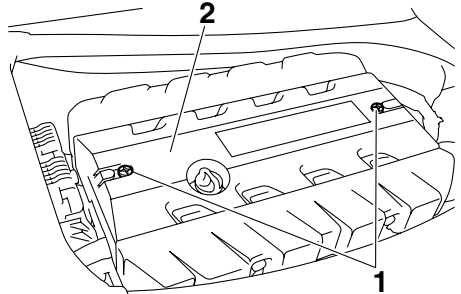

- 1 Engine cover screw
- 2 Engine cover

- (3) Remove the spark plug cap bolts, and then remove the spark plug cap. **NOTICE:** Do not use any tools to remove or install the spark plug cap, otherwise the ignition coil coupler could be damaged. The spark plug cap may be difficult to remove because the rubber seal on the end of the cap fits tightly. To remove the spark plug cap, simply twist it back and forth while pulling it up; to install it, twist it back and forth while pushing it down. [ECJ00211]

Maintenance and care

TIP:

If removing the spark plug cap nearest the stern, remove the plastic tie that is securing the wiring harness before removing the cap.

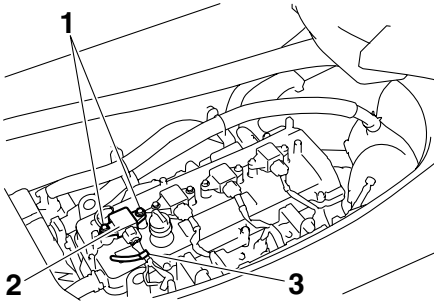

- 1 Spark plug cap bolt
- 2 Spark plug cap
- 3 Plastic tie

- (4) Remove the spark plug. Measure the spark plug gap with a wire thickness gauge. Replace the spark plug or adjust the gap to specification if necessary.

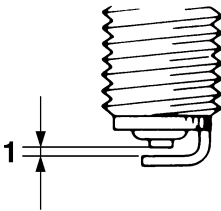

- 1 Spark plug gap

Spark plug gap:
0.8–0.9 mm (0.031–0.035 in)

To install a spark plug:

- (1) Clean the gasket surface.
- (2) Wipe any dirt from the threads of the spark plug.

- (3) Install the spark plug, and then tighten it to the specified torque.

Spark plug tightening torque:
24.5 Nm (2.50 kgf-m, 18.1 ft-lb)

TIP:

If a torque wrench is not available when you are installing a spark plug, a good estimate of the correct torque is 1/4 turn to 1/2 turn past finger tight using the spark plug wrench included in the tool kit. Have the spark plug adjusted to the correct torque with a torque wrench as soon as possible.

- (4) Wipe off any water on the spark plug or inside the spark plug cap, and then install the cap. Push the spark plug cap down until it is securely installed, and then install the spark plug cap bolts and tighten them to the specified torque.

If the spark plug cap nearest the stern was removed, secure the wiring harness by installing the plastic tie after installing the cap.

Spark plug cap bolt tightening torque:
7.6 Nm (0.77 kgf-m, 5.6 ft-lb)

- (5) Install the engine cover and engine cover screws, and then install the seats.

EJU36970

Lubrication points

To keep moving parts sliding or rotating smoothly, coat them with water-resistant grease.

Recommended water-resistant grease:
Yamaha Marine Grease/Yamaha Grease A

- Throttle cable (handlebar end)
Loosen the adjuster and disconnect the outer cable from the bracket. Spray a rust inhibitor into the outer cable. Connect the

Maintenance and care

outer cable, and then adjust the throttle cable free play. (See page 90 for adjustment procedures.)

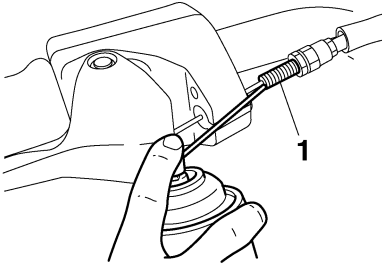

1 Adjuster

- Steering cable (handlebar end)

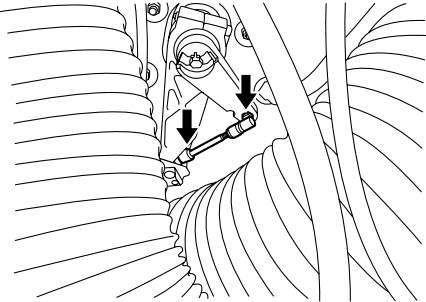

- Steering cable (jet thrust nozzle end)
- QSTS rod (jet thrust nozzle end)

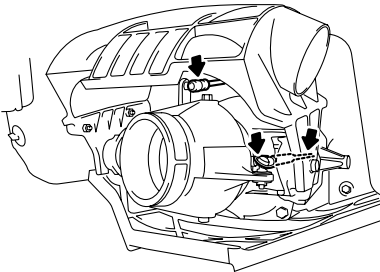

- Shift cable (shift lever end)

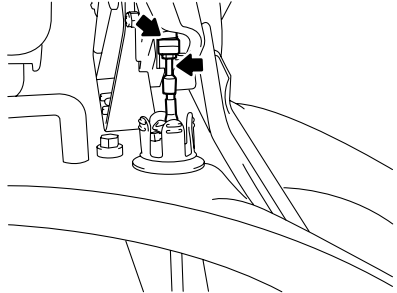

- Shift cable (reverse gate end)

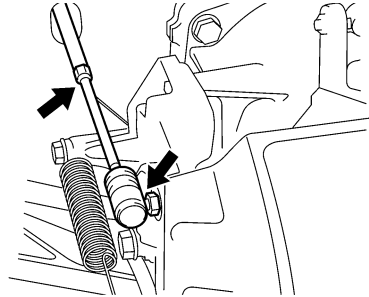

- Intermediate housing

Fill the intermediate housing with water-resistant grease through the grease nipple using a grease gun.

Maintenance and care

Grease quantity:

Initial 10 hours or 1 month:

33.0–35.0 cm³ (1.12–1.18 US oz,
1.16–1.23 Imp.oz)

Every 100 hours or 12 months:

6.0–8.0 cm³ (0.20–0.27 US oz,
0.21–0.28 Imp.oz)

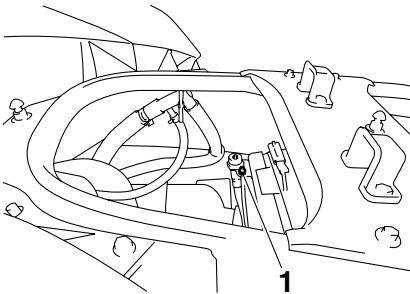

1 Grease nipple

EJU34452

Checking the battery

Check the level of the battery electrolyte and make sure that the negative (–) and positive (+) battery leads are tightened securely.

EWJ00791

⚠ WARNING

Battery electrolyte is poisonous and dangerous, causing severe burns, etc. Electrolyte contains sulfuric acid. Avoid contact with skin, eyes, or clothing.

Antidotes

External: Flush with water.

Internal: Drink large quantities of water or milk. Follow with milk of magnesia, beaten egg, or vegetable oil. Call a physician immediately.

Eyes: Flush with water for 15 minutes and get prompt medical attention.

Batteries produce explosive gases. Keep sparks, flames, cigarettes, etc., well away. If using or charging the battery in an enclosed space, make sure that it is well ven-

tilated. Always shield your eyes when working near batteries.

Keep out of the reach of children.

To remove the battery:

Disconnect the negative (–) battery lead first, then the positive (+) battery lead and breather hose, and then remove the battery from the watercraft.

To replenish the battery:

- (1) Make sure that the electrolyte level is between the maximum and minimum level marks.

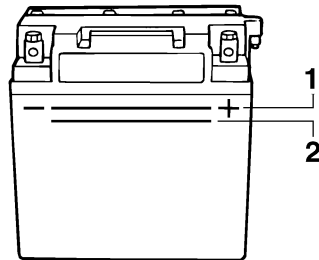

1 Maximum level mark

2 Minimum level mark

- (2) If the electrolyte level is low, add distilled water to raise it to the specified level.

NOTICE: Use only distilled water for replenishing the battery, otherwise battery life could be shortened. [EJC00241]

To recharge the battery:

EGJ00250

NOTICE

Do not attempt to charge a battery hastily. Battery life could be shortened.

It is recommended to have a Yamaha dealer charge the battery. If you charge the battery yourself, be sure to read and follow the instructions provided with the battery tester and charger you use.

To install the battery:

- (1) Place the battery in the battery compartment. Connect the red lead to the positive (+) battery terminal, and then connect the black lead to the negative (-) battery terminal. **NOTICE: Reversal of the battery leads will damage the electrical parts.**

[ECJ00261]

- (2) Connect the breather hose to the battery.
- (3) Secure the battery in place. **WARNING! Fire or explosion could result if the breather hose is damaged, obstructed, or not connected properly.** [EVJ00451]

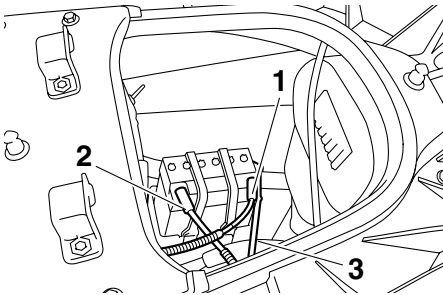

- 1 Positive (+) battery terminal: Red lead
- 2 Negative (-) battery terminal: Black lead
- 3 Breather hose

EJU34491

Fuel injection system

If the fuel injection system is malfunctioning, have a Yamaha dealer service the watercraft.

EJU34500

Checking the trolling speed

- (1) Place the watercraft in the water.
- (2) Start the engine and warm it up. Use the tachometer in the multifunction information center to check the trolling speed.

Trolling speed: 1250 ±100 r/min

If the trolling speed is out of specification, have a Yamaha dealer service the watercraft.

Specifications

EJU34542

Specifications

Watercraft capacity:

Maximum people on board:

3 person

Maximum load capacity:

240 kg (530 lb)

Dimensions:

Length:

3370 mm (132.7 in)

Width:

1230 mm (48.4 in)

Height:

FX SHO 1160 mm (45.7 in)

FX Cruiser SHO 1240 mm (48.8 in)

Dry weight:

FX SHO 376 kg (829 lb)

FX Cruiser SHO 381 kg (840 lb)

Performance:

Maximum fuel consumption:

71.3 L/h (18.8 US gal/h, 15.7 Imp.gal/h)

Cruising range at full throttle:

0.98 hour

Trolling speed:

1250 ±100 r/min

Engine:

Engine type:

Liquid cooled 4-stroke, DOHC

Number of cylinders:

4

Engine displacement:

1812 cm³

Bore & stroke:

86.0 × 78.0 mm (3.39 × 3.07 in)

Compression ratio:

8.6 : 1

Valve clearance-intake (cold):

0.14–0.23 mm (0.0055–0.0091 in)

Valve clearance-exhaust (cold):

0.28–0.37 mm (0.0110–0.0146 in)

Lubrication system:

Wet sump

Cooling system:

Water

Starting system:

Electric

Ignition system:

T.C.I.

Spark plug:

LFR6A

Spark plug gap:

0.8–0.9 mm (0.031–0.035 in)

Battery capacity:

12 V, 19.0 Ah

Charging system:

Flywheel magnet

Drive unit:

Propulsion system:

Jet pump

Jet pump type:

Axial flow, single stage

Impeller rotation:

Counterclockwise

Jet thrust nozzle angle:

24.0+24.0 °

Jet thrust nozzle trim angle:

-10, -5, 0, 5, 10 °

Fuel and oil:

Recommended fuel:

Regular unleaded gasoline

Minimum octane rating (PON):

86

Minimum octane rating (RON):

90

Recommended engine oil type SAE:

SAE 10W-30, 10W-40, 20W-40, 20W-50

Recommended engine oil grade API:

API SE,SF,SG,SH,SJ,SL

Fuel tank total capacity:

70 L (18.5 US gal, 15.4 Imp.gal)

Engine oil quantity with oil filter replacement:

3.1 L (3.28 US qt, 2.73 Imp.qt)

Engine oil quantity without oil filter replacement:

3.0 L (3.17 US qt, 2.64 Imp.qt)

Engine oil total quantity:

4.3 L (4.55 US qt, 3.78 Imp.qt)

EJU34560

Troubleshooting

If you have any trouble with your watercraft, use this section to check for the possible cause. If you cannot find the cause, or if the procedure for replacement or repair is not described in this owner's/operator's manual, have a Yamaha dealer perform the necessary service.

EJU36982

Troubleshooting chart

TROUBLE	POSSIBLE CAUSE		REMEDY	PAGE
Engine does not start (Starter motor does not turn over)	Yamaha Security System	Lock mode selected	Select unlock mode	40
	Engine shut-off switch	Clip not in place	Install clip	33
	Fuse	Burned out	Replace fuse and check wiring	102
	Battery	Run down	Recharge	95
		Poor terminal connections	Tighten as required	95
		Terminal corroded	Clean	84
	Starter motor	Faulty	Have serviced by Yamaha dealer	—
Engine does not start (Starter motor turns over)	Throttle lever	Squeezed	Release	33
	Fuel	Empty	Refill as soon as possible	57
		Stale or contaminated	Have serviced by Yamaha dealer	89
	Fuel tank	Water or dirt present	Have serviced by Yamaha dealer	89
	Spark plug	Fouled or defective	Clean or replace	92
	Spark plug cap	Not connected or loose	Connect properly	92
		Connected to wrong cylinder	Connect properly	92
Fuel injection system	Fuel pump faulty	Have serviced by Yamaha dealer	—	

Trouble recovery

TROUBLE	POSSIBLE CAUSE		REMEDY	PAGE
Engine runs irregularly or stalls	Fuel	Empty	Refill as soon as possible	57
		Stale or contaminated	Have serviced by Yamaha dealer	89
	Fuel tank	Water or dirt present	Have serviced by Yamaha dealer	89
	Spark plug	Fouled or defective	Replace	92
		Incorrect heat range	Replace	92
		Gap incorrect	Adjust	92
	Spark plug cap	Loose	Connect properly	92
		Cracked, torn, or damaged	Have serviced by Yamaha dealer	—
	Electrical wiring	Loose connection	Have serviced by Yamaha dealer	—
Fuel injection system	Faulty or clogged injectors	Have serviced by Yamaha dealer	—	
Warning light or indicator blinks	Fuel level	Empty	Refill as soon as possible	57
	Oil pressure warning	Oil pressure dropped	Have serviced by Yamaha dealer	49
	Engine overheated	Jet intake clogged	Clean	101
	Check engine warning	Faulty sensors	Have serviced by Yamaha dealer	50

Trouble recovery

TROUBLE	POSSIBLE CAUSE		REMEDY	PAGE
Watercraft slow or loses power	Shift lever	Not completely shifted into forward position	Push lever forward until it stops	36
	Yamaha Security System	Low-RPM mode selected	Select normal mode	41
	Cavitation	Jet intake clogged	Clean	101
		Impeller damaged or worn	Have serviced by Yamaha dealer	101
	Engine over-heat warning	Engine speed reduction control activated	Clean jet intake and cool engine	50
	Oil pressure warning	Engine speed reduction control activated	Add oil	49
	Spark plug	Fouled or defective	Replace	92
		Incorrect heat range	Replace	92
		Gap incorrect	Adjust	92
	Spark plug cap	Loose	Connect properly	92
	Electrical wiring	Loose connection	Have serviced by Yamaha dealer	—
	Fuel	Stale or contaminated	Have serviced by Yamaha dealer	89
	Air filter	Clogged	Have serviced by Yamaha dealer	89
Oil buildup		Have serviced by Yamaha dealer	89	

Trouble recovery

EJU34620

Emergency procedures

EJU34631

Cleaning the jet intake and impeller

EWJ00780

WARNING

Before attempting to remove weeds or debris from the jet intake or impeller area, shut the engine off and remove the clip from the engine shut-off switch. Severe injury or death could result from coming in contact with the rotating parts of the jet pump.

If weeds or debris gets caught in the jet intake or impeller, cavitation can occur, causing jet thrust to decrease even though engine speed rises. If this condition is allowed to continue, the engine will overheat and may seize. **NOTICE:** If weeds or debris gets caught in the jet intake, do not operate the watercraft above trolling speed until they have been removed. [ECJ00651]

If there is any sign that the jet intake or impeller is clogged with weeds or debris, return to shore and check the intake and impeller. Al-

ways stop the engine before beaching the watercraft.

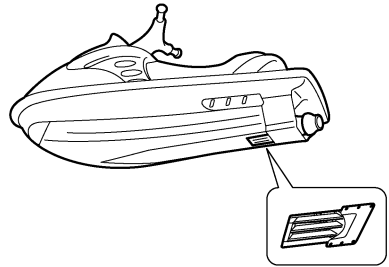
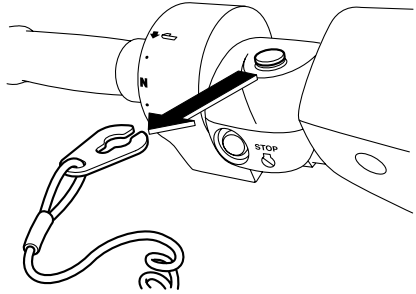

- (1) Place a suitable clean cloth or carpeting underneath the watercraft to protect it from abrasions and scratches. Turn the watercraft on its side as shown. **NOTICE:** Always turn the watercraft over onto its port (left) side. When turning the watercraft on its side, support the bow so that the handlebars are not bent or damaged. [ECJ00661]

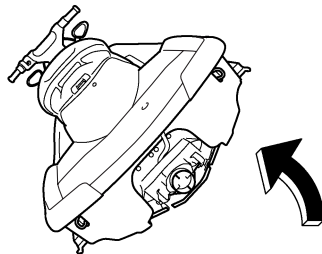

- (2) Remove any weeds or debris from around the jet intake, drive shaft, impeller, jet pump housing, and jet thrust nozzle.

If debris is difficult to remove, consult a Yamaha dealer.

EJU34641

Jumping the battery

If the watercraft battery has run down, the engine can be started using a 12-volt booster battery and jumper cables.

EJU34662

Connecting the jumper cables

EWJ01250

WARNING

To avoid battery explosion and serious damage to the electrical system:

- Do not reverse the polarity of the jumper cables when connecting to the batteries.
- Do not connect the negative (–) jumper cable to the negative (–) terminal of the watercraft battery.
- Do not touch the positive (+) jumper cable to the negative (–) jumper cable.

- (1) Connect the positive (+) jumper cable to the positive (+) battery terminals of both batteries.
- (2) Connect one end of the negative (–) jumper cable to the negative (–) battery terminal of the booster battery.

- (3) Connect the other end of the negative (–) jumper cable to an engine hanger.

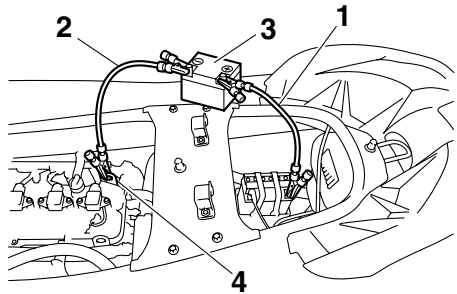

- 1 Positive (+) jumper cable
- 2 Negative (–) jumper cable
- 3 Booster battery
- 4 Engine hanger

- (4) Start the engine, and then disconnect the jumper cables by reversing the steps above. **NOTICE: Never push the start switch while the engine is running. Do not operate the start switch for more than 5 seconds, otherwise the battery will be discharged and the engine will not start. Also, the starter motor could be damaged. If the engine does not start in 5 seconds, release the start switch, wait 15 seconds, and then try again.** [ECJ00481]

EJU36991

Replacing the fuses

The fuses are located in the electrical box.

To replace a fuse:

- (1) Remove the seats. (See page 30 for seat removal and installation procedures.)

Trouble recovery

- (2) Remove the electrical box cover.

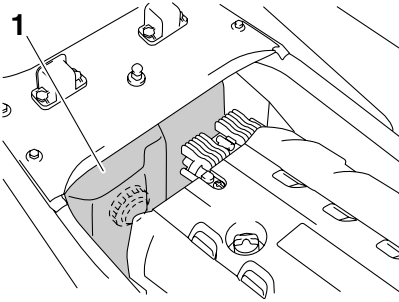

1 Electrical box cover

- (3) Remove the cap on the electrical box.
(4) Replace the blown fuse with the spare fuse of the correct amperage by using the fuse puller on the reverse side of the cap.

WARNING! Do not use fuses of higher amperage than recommended. Substitution with a fuse that has an improper rating can cause extensive electrical

system damage and possible fire.

[EWJ00801]

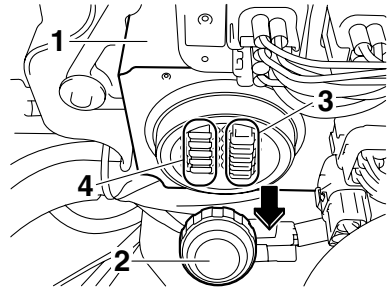

- 1 Electrical box
2 Cap
3 Fuse
4 Spare fuse

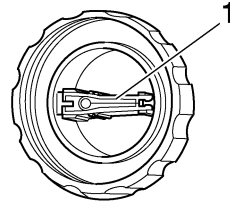

1 Fuse puller

Fuse amperage:

Battery fuse:

30 A

Main relay drive fuse:

10 A

Electronic throttle valve fuse:

10 A

Security system fuse:

3 A

Main fuse:

20 A

- (5) Install the cap.
(6) Install the electrical box cover.
(7) Install the seats.

EJU34711

Towing the watercraft

EWJ00811



- The operator of the towing boat must keep speed to a minimum and avoid traffic or obstacles which could be a hazard to the operator on the watercraft.
- The towline should be long enough so that the watercraft will not collide with the towing boat when slowing down.

If the watercraft becomes inoperative in the water, it can be towed to shore.

When the watercraft is towed using a towline, the operator should hold onto the handlebars and ride the watercraft in order to balance it. Use a towline that is three times the combined length of the towing boat and the watercraft.

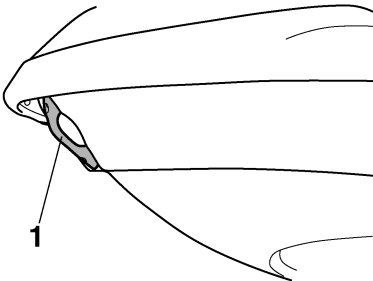

1 Bow eye

Tow the watercraft at 5 mph (8 km/h) or less. The bow must be kept up out of the water during towing to prevent water from entering the engine compartment.

EJU36151

Submerged watercraft

If the watercraft is submerged or flooded with water, follow the procedure below and consult a Yamaha dealer as soon as possible. Failure to do so could result in serious engine damage.

- (1) Beach the watercraft and remove the stern drain plugs to drain the water from

the engine compartment. (See page 63 for more information.)

Remove the storage compartment drain plugs to drain the water from the storage compartments.

- (2) Install the stern drain plugs and storage compartment drain plugs.
- (3) Have the watercraft inspected by a Yamaha dealer as soon as possible.

NOTICE: Be sure to have a Yamaha dealer inspect the watercraft. Otherwise, serious engine damage could result. [ECJ00791]

Consumer information

EJU34780

Limited warranty

YAMAHA MOTOR CORPORATION, U.S.A. WATERCRAFT LIMITED WARRANTY

Yamaha Motor Corporation is proud of its heritage and reputation for producing products with high standards of quality and workmanship. Product excellence provides the cornerstone for our commitment to customer satisfaction. The Yamaha Watercraft Limited Warranty is your assurance of this commitment.

This warranty provides you with protection against the expense of repairs for your watercraft that are required as a result of defects in materials or workmanship. When maintained and utilized in the prescribed manner, you can count on your Yamaha watercraft to provide reliable service.

This warranty provides you with specific coverage and notes your responsibilities in maintaining and operating your watercraft. Please take the time to read and become familiar with this warranty.

PERIOD OF WARRANTY. Any new Yamaha watercraft purchased for pleasure use from an authorized Yamaha dealer in the United States, will be warranted against defects in material or workmanship for a period of one (1) year from date of purchase, subject to exclusions noted herein. Any Yamaha Watercraft purchased and utilized for commercial applications will be warranted for a period of ninety [90] days from the date of purchase, subject to exclusions noted herein. Replacement parts used in warranty repairs will be warranted for the balance of the applicable warranty period.

The warranty described here applies to watercrafts purchased and registered for use in the United States only. For warranty provisions outside the United States, contact the particular country's local Yamaha distributor.

OBTAINING REPAIRS UNDER WARRANTY. During the period of warranty, any authorized Yamaha dealer will, free of charge, repair or replace, at Yamaha's option, any parts adjudged defective by Yamaha due to faulty workmanship or material from the factory. All parts replaced under warranty will become the property of Yamaha Motor Corporation, U.S.A.

CUSTOMER'S RESPONSIBILITY. Under the terms of this warranty, the customer will be responsible for ensuring that the watercraft is properly operated, maintained, and stored as specified in the applicable Owner's/Operator's Manual.

The owner of the watercraft shall give notice to an authorized Yamaha dealer of any and all apparent defects within ten [10] days of discovery and make the watercraft available at that time for inspection and repairs at the dealer's place of business.

GENERAL EXCLUSIONS FROM WARRANTY. This warranty will not cover the repair of damage if the damage is a result of abuse or neglect of the product. Examples of abuse and neglect include, but are not limited to:

1. Racing or competition use, modification of original parts abnormal strain.
2. Lack of proper maintenance and off season storage as described in the Owner's/Operator's Manual, installation of parts or accessories that are not equivalent in design and quality to genuine Yamaha parts.
3. Use of lubricants, oils, and fuel/oil mixtures that are not suitable for watercraft or motor use.
4. Damage as a result of accidents, collisions, contact with foreign materials, or submersion.
5. Growth of marine organisms on motor or hull surfaces.
6. Normal deterioration.
7. Gel coat stress cracks.

SPECIFIC PARTS EXCLUDED FROM WARRANTY.

Parts replaced due to normal wear or routine maintenance such as oil, spark plugs, fuel filters, impeller and liner, and anodes are not covered by warranty. Charges for transporting the watercraft to and from an authorized Yamaha dealer are excluded from warranty coverage.

TRANSFER OF WARRANTY. Transfer of the warranty from the original purchaser to any subsequent purchaser is possible by having the watercraft inspected by an authorized Yamaha dealer and requesting the dealer to submit a change of registration to Yamaha Motor Corporation, U.S.A. within ten [10] days of the transfer.

YAMAHA MOTOR CORPORATION, U.S.A. MAKES NO OTHER WARRANTY OF ANY KIND, EXPRESSED OR IMPLIED. ALL IMPLIED WARRANTIES OF MERCHANTABILITY AND FITNESS FOR A PARTICULAR PURPOSE WHICH EXCEED THE OBLIGATIONS AND TIME LIMITS STATED IN THIS WARRANTY ARE HEREBY DISCLAIMED BY YAMAHA MOTOR CORPORATION, U.S.A. AND EXCLUDED FROM THIS WARRANTY.

SOME STATES DO NOT ALLOW LIMITATIONS ON HOW LONG AN IMPLIED WARRANTY LASTS, SO THE ABOVE LIMITATION MAY NOT APPLY TO YOU. ALSO EXCLUDED FROM THIS WARRANTY ARE ANY INCIDENTAL OR CONSEQUENTIAL DAMAGES INCLUDING LOSS OF USE. SOME STATES DO NOT ALLOW THE EXCLUSION OR LIMITATION OF INCIDENTAL OR CONSEQUENTIAL DAMAGES, SO THE ABOVE EXCLUSION MAY NOT APPLY TO YOU.

Consumer information

THIS WARRANTY GIVES YOU SPECIFIC LEGAL RIGHTS, AND YOU MAY ALSO HAVE OTHER RIGHTS WHICH VARY FROM STATE TO STATE.

YAMAHA MOTOR CORPORATION, U.S.A.
Post Office Box 6555
Cypress, California 90630

WARRANTY QUESTIONS AND ANSWERS

- Q. What costs are my responsibility during the warranty period?
- A. The customer's responsibility includes all costs of normal maintenance services, non-warranty repairs, accident and collision damages.
- Q. What are some examples of "abnormal" strain, neglect, or abuse?
- A. These terms are general and overlap each other in areas. Specific examples include:
Running the watercraft out of oil, operating the machine with a broken or damaged part which causes another part to fail, and so on. If you have any specific questions on operation or maintenance, please contact your Yamaha dealer for advice.
- Q. Does the warranty cover incidental costs such as transportation due to a failure?
- A. No. The warranty is limited to repair of the watercraft itself.
- Q. May I perform any or all of the recommended maintenance shown in the Owner's/Operator's Manual instead of having the dealer do them?
- A. Yes, if you are a qualified mechanic and follow the procedures specified in the Owner's/Operator's and Service Manual. We do recommend, however, that items requiring special or equipment be done by a Yamaha dealer.
- Q. Will the warranty be void or cancelled if I do not operate or maintain my new watercraft exactly as specified in the Owner's/Operator's Manual?
- A. No. The warranty on a new watercraft cannot be "voided" or "cancelled". **However, if a particular failure is caused by operation or maintenance other than as shown in the Owner's/Operator's Manual, that failure may not be covered under warranty.**
- Q. What responsibility does my dealer have under this warranty?
- A. Each Yamaha dealer is expected to:
1. Completely set up each new watercraft before sale.
 2. Explain the operation, maintenance, and warranty requirements to your satisfaction at the time of sale, and upon your request at any later date. In addition, each Yamaha dealer is held responsible for his setup, service and warranty repair work.
- Q. Is the warranty transferable to second owners?
- A. Yes. The remainder of the existing warranty can be transferred upon request. The unit has to be inspected and re-registered by an authorized Yamaha dealer for the policy to remain effective.

CUSTOMER SERVICE

If your watercraft requires warranty service, you must take it to any authorized Yamaha dealer within the continental United States. Be sure to bring your warranty registration card or other valid proof of the original date of purchase. If a question or problem arises regarding warranty, first contact the owner of the dealership. Since all warranty matters are handled at the dealer level, this person is in the best position to help you. If you are still not satisfied and require additional assistance, please write:

YAMAHA MOTOR CORPORATION U.S.A.
CUSTOMER RELATIONS DEPARTMENT
P.O. Box 6555
Cypress, California 90630

CHANGE OF ADDRESS

The federal government requires each manufacturer to maintain a complete, up-to-date list of all first purchasers against the possibility of a safety-related defect and recall. This list is compiled from the purchase registrations sent to Yamaha Motor Corporation, U.S.A. by the selling dealer at the time of your purchase.

If you should move after you have purchased your new watercraft, please advise us of your new address by sending a postcard listing your Yamaha model name, engine number, dealer number [or dealer's name] as it is shown on your warranty card, your name and new mailing address.

Mail to:

YAMAHA MOTOR CORPORATION, U.S.A.
P.O. Box 6555
Cypress, California 90630
Attention: Warranty Department

This will ensure that Yamaha Motor Corporation, U.S.A. has an up-to-date registration record in accordance with federal law.

Consumer information

EJU34800

YAMAHA EXTENDED SERVICE (Y.E.S.)

Keep your Yamaha protected even after your warranty expires with genuine Yamaha Extended Service (Y.E.S.).

- Y.E.S. is designed and administered by Yamaha Motor Corporation to provide maximum owner satisfaction. You get uninterrupted factory-backed coverage for extra peace of mind.
- Y.E.S. is flexible. You choose the plan that is right for you: 12 months, 24 months, 36 months, or (on four-stroke models) 48 months beyond your warranty period.
- Y.E.S. is designed and administered by the same Yamaha people who handle your warranty—and it shows in the comprehensive coverage benefits. There are no mileage limitations. Coverage is not limited to “moving parts” or the “drive train” like many other plans. And Y.E.S. covers manufacturing defects just like the warranty. See the sample contract at your Yamaha dealer to see how comforting uninterrupted factory-backed protection can be.
- You do not have to pay anything for covered repairs. There is no deductible to pay, and repairs are not “pro-rated.” You do not have any “out-of-pocket” expenses for covered repairs.
- In addition, Travel and Recreation Interruption Protection (TRIP) is included at no extra cost. TRIP gives you up to \$150 reimbursement per occurrence for any reasonable expenses you incur because your Yamaha needs covered service: replacement vehicle rental, emergency towing, phone calls, even food and lodging when you are away from home. This superb coverage goes into effect when you purchase Y.E.S., so it applies to any warranty repairs as well as covered repairs during your entire Y.E.S. plan period.
- Y.E.S. coverage is honored at any authorized Yamaha dealer nationwide.
- Y.E.S. coverage is transferable to a new owner if you sell or trade-in. That can make your Yamaha much more valuable!

This excellent Y.E.S. plan coverage is only available to Yamaha owners like you, and only while your Yamaha is still within the Yamaha Limited Warranty period. So visit your authorized Yamaha dealer to get all the facts. He can show you how easy it is to protect your investment with Yamaha Extended Service.

We urge you to act now. You will get the excellent benefits of TRIP coverage right away, and you will rest easy knowing you will have strong factory-backed protection even after your Yamaha Limited Warranty expires.

A special note:

If visiting your dealer is not convenient, contact Yamaha with your Primary ID number (your Owner's Manual shows you where to find this number). We will be happy to help you get the Y.E.S. coverage you need.

Yamaha Service Marketing
P.O. Box 6555
Cypress, CA 90630
1-(866)-YES-EXTD
(1-866-937-3983)



YAMAHA EXTENDED SERVICE

A		Enjoy your watercraft responsibly	25
Air filter element	89	F	
Analog speedometer/tachometer	45	Fire extinguisher	64
Analog speedometer/tachometer and indicator lights	45	Flushing the cooling system	83
Approval label of emission control certificate	2	Front storage compartment	54
B		Fuel	57
Battery	63, 84	Fuel and oil	57
Battery, checking	95	Fuel injection system	96
Battery, jumping	102	Fuel level	61
Beaching the watercraft	80	Fuel level meter	48
Beverage holder	56	Fuel level warning indicator	49
Bilge	63	Fuel system, checking	89
Boarding alone	75	Fuel tank	89
Boarding and starting from a dock	74	Fuel tank filler cap	31
Boarding and starting in deep water	74	Fuses, replacing	102
Boarding and starting in shallow water	74	G	
Boarding with passengers	75	Getting to know your watercraft	72
Bow down	37	Glove compartment	55
Bow eye	38	H	
Bow up	37	Handgrip	38
C		Hazard information	16
Capsized watercraft	77	Hood	31
Check engine warning indicator	50	Hour meter/voltmeter	49
Cleaning the watercraft	84	Hull and deck	61
Cooling water pilot outlets	34, 68	Hull Identification Number (HIN)	1
Cruise assist	42	I	
Cruising limitations	11	Identification numbers	1
D		J	
Digital speedometer	48	Jet intake	67
Docking the watercraft	80	Jet intake and impeller, cleaning	101
E		Jet thrust nozzle angle, checking	89
Emergency procedures	101	Jumper cables, connecting	102
Emission control information	2	L	
Engine break-in	69	Labels, important	5
Engine compartment	61	Labels, other	8
Engine oil	58	Labels, warning	6
Engine oil and oil filter	89	Launching the watercraft	69
Engine oil level	61	Learning to operate your watercraft	72
Engine overheat warning indicator	50	Leaving the watercraft	71
Engine serial number	1	Left multifunction display and operation buttons	47
Engine shut-off cord (lanyard)	67	Limitations on who may operate the watercraft	10
Engine shut-off switch	33	Limited warranty	105
Engine stop switch	33	"L-MODE" indicator light	47

Index

Lubrication.....	84	Selecting the operation mode	41
Lubrication points	93	“SET” switch	34
M		Shift cable, checking	90
Main components, location of	26	Shift lever	36
Maintenance and adjustments	85	Shift lever and reverse gate	65
Manufactured date label.....	3	Shifting	71
Multifunction information center	44, 68	Spark plugs, cleaning and adjusting	92
N		“SPEED” indicator light	46
No-wake mode	41	Star labels	3
“NO-WAKE MODE” switch.....	34	Start switch.....	33
O		Starting the engine	69
Oil pressure warning indicator.....	49	Starting the watercraft	73
Operating in weeded areas	81	Steering system	35, 65
Operating your watercraft.....	72	Stern drain plugs	63
Operation	69	Stern eyes	39
Operation of controls and other functions	30	Stopping the engine	70
Operation requirements	13	Stopping the watercraft	79
Owner’s/operator’s manual and tool kit....	85	Storage.....	83
P		Storage compartments.....	54
Periodic maintenance chart.....	87	Submerged watercraft.....	104
Post-operation care.....	81	Switches.....	67
Pre-operation check list.....	59	Switches, right handlebar	34
Pre-operation check points	61	T	
Pre-operation checks	59	Throttle cable, checking and adjusting	90
Primary Identification (PRI-ID) number	1	Throttle lever	34, 64
Pull-up cleats (for FX Cruiser SHO)	39	Tilt lever.....	35
Q		To get more boating safety information....	24
Quick Shift Trim System (QSTS)	66	Towing the watercraft.....	104
Quick Shift Trim System (QSTS) selector	36	Transporting	82
R		Trolling speed, checking	96
Reboarding step.....	38	Troubleshooting	98
Recommended equipment.....	15	Troubleshooting chart	98
Remote control transmitter.....	31	Turning the watercraft	78
Reverse on waterways.....	80	U	
Riding with passengers.....	73	“UNLOCK” indicator light.....	47
Right multifunction display and operation buttons (for FX Cruiser SHO)	51	Up and down switches	34
“RPM” indicator light.....	46	W	
Rules of the Road	20	“WARNING” indicator light	47
S		Water separator	62
Seat storage compartment.....	55	Watercraft characteristics.....	16
Seats	30	Water-skiing	18
		Watertight compartment.....	56
		Y	
		Yamaha Engine Management System (YEMS)	39

YAMAHA EXTENDED SERVICE (Y.E.S.)	107
Yamaha Security System	39
Yamaha Security System settings	40



Printed in USA
June 2008-2.8 × 1 CR

Free Manuals Download Website

<http://myh66.com>

<http://usermanuals.us>

<http://www.somanuals.com>

<http://www.4manuals.cc>

<http://www.manual-lib.com>

<http://www.404manual.com>

<http://www.luxmanual.com>

<http://aubethermostatmanual.com>

Golf course search by state

<http://golfingnear.com>

Email search by domain

<http://emailbydomain.com>

Auto manuals search

<http://auto.somanuals.com>

TV manuals search

<http://tv.somanuals.com>