



**YAMAHA**

**138**

**OWNER'S MANUAL**



**YZF-R1N**  
**YZF-R1NC**  
**5JJ-28199-11**

**LIT-11626-14-35**

EAU03438

 **WARNING**

**The engine exhaust from this product contains chemicals known to the State of California to cause cancer, birth defects or other reproductive harm.**

YAMAHA

LIT-CALIF-65-01

Congratulations on your purchase of the Yamaha YZF-R1 / YZF-R1C. This model is the result of Yamaha's vast experience in the production of fine sporting, touring, and pacesetting racing machines. It represents the high degree of craftsmanship and reliability that have made Yamaha a leader in these fields.

This manual will give you an understanding of the operation, inspection, and basic maintenance of this motorcycle. If you have any questions concerning the operation or maintenance of your motorcycle, please consult a Yamaha dealer.

The design and manufacture of this Yamaha motorcycle fully comply with the emissions standards for clean air applicable at the date of manufacture. Yamaha has met these standards without reducing the performance or economy of operation of the motorcycle. To maintain these high standards, it is important that you and your Yamaha dealer pay close attention to the recommended maintenance schedules and operating instructions contained within this manual.

# IMPORTANT MANUAL INFORMATION

---

EAU00003

Particularly important information is distinguished in this manual by the following notations:



The Safety Alert Symbol means **ATTENTION! BECOME ALERT! YOUR SAFETY IS INVOLVED!**



Failure to follow **WARNING** instructions could result in severe injury or death to the motorcycle operator, a bystander or a person inspecting or repairing the motorcycle.

**CAUTION:**

A **CAUTION** indicates special precautions that must be taken to avoid damage to the motorcycle.

**NOTE:**

A **NOTE** provides key information to make procedures easier or clearer.

## **NOTE:**

- This manual should be considered a permanent part of this motorcycle and should remain with it even if the motorcycle is subsequently sold.
  - Yamaha continually seeks advancements in product design and quality. Therefore, while this manual contains the most current product information available at the time of printing, there may be minor discrepancies between your motorcycle and this manual. If you have any questions concerning this manual, please consult your Yamaha dealer.
-

---

# IMPORTANT MANUAL INFORMATION

---

EW000000

 **WARNING**

**PLEASE READ THIS MANUAL AND THE “YOU AND YOUR MOTORCYCLE: RIDING TIPS” BOOKLET CAREFULLY AND COMPLETELY BEFORE OPERATING THIS MOTORCYCLE. DO NOT ATTEMPT TO OPERATE THIS MOTORCYCLE UNTIL YOU HAVE ATTAINED ADEQUATE KNOWLEDGE OF ITS CONTROLS AND OPERATING FEATURES AND UNTIL YOU HAVE BEEN TRAINED IN SAFE AND PROPER RIDING TECHNIQUES. REGULAR INSPECTIONS AND CAREFUL MAINTENANCE, ALONG WITH GOOD RIDING SKILLS, WILL ENSURE THAT YOU SAFELY ENJOY THE CAPABILITIES AND THE RELIABILITY OF THIS MOTORCYCLE.**

---

# IMPORTANT MANUAL INFORMATION

---

AFFIX DEALER

LABEL HERE

EAU03336

**YZF-R1N/YZF-R1NC  
OWNER'S MANUAL**  
© 2000 by Yamaha Motor Corporation, U.S.A.  
1st Edition, July 2000  
All rights reserved.  
Any reprinting or unauthorized use  
without the written permission of  
Yamaha Motor Corporation, U.S.A.  
is expressly prohibited.  
Printed in Japan.  
P/N LIT-11626-14-35

1	SAFETY INFORMATION	1
2	DESCRIPTION	2
3	INSTRUMENT AND CONTROL FUNCTIONS	3
4	PRE-OPERATION CHECKS	4
5	OPERATION AND IMPORTANT RIDING POINTS	5
6	PERIODIC MAINTENANCE AND MINOR REPAIR	6
7	MOTORCYCLE CARE AND STORAGE	7
8	SPECIFICATIONS	8
9	CONSUMER INFORMATION	9
	INDEX	

Safe riding ..... 1-1  
Protective apparel ..... 1-3  
Modifications ..... 1-3  
Loading and accessories ..... 1-3  
Gasoline and exhaust gas..... 1-5  
Location of important labels ..... 1-7



MOTORCYCLES ARE SINGLE TRACK VEHICLES. THEIR SAFE USE AND OPERATION ARE DEPENDENT UPON THE USE OF PROPER RIDING TECHNIQUES AS WELL AS THE EXPERTISE OF THE OPERATOR. EVERY OPERATOR SHOULD KNOW THE FOLLOWING REQUIREMENTS BEFORE RIDING THIS MOTORCYCLE.

HE OR SHE SHOULD:

1. OBTAIN THOROUGH INSTRUCTIONS FROM A COMPETENT SOURCE ON ALL ASPECTS OF MOTORCYCLE OPERATION.
2. OBSERVE THE WARNINGS AND MAINTENANCE REQUIREMENTS IN THE OWNER'S MANUAL.
3. OBTAIN QUALIFIED TRAINING IN SAFE AND PROPER RIDING TECHNIQUES.
4. OBTAIN PROFESSIONAL TECHNICAL SERVICE AS INDICATED BY THE OWNER'S MANUAL AND/OR WHEN MADE NECESSARY BY MECHANICAL CONDITIONS.

## Safe riding

1. Always make pre-operation checks. Careful checks may help prevent an accident.
2. This motorcycle is designed to carry the operator and a passenger.
3. The failure of motorists to detect and recognize motorcycles in traffic is the predominating cause of automobile/motorcycle accidents. Many accidents have been caused by an automobile driver who did not see the motorcycle. Making yourself conspicuous appears to be very effective in reducing the chance of this type of accident.

Therefore:

- a. Wear a brightly colored jacket.
- b. Use extra caution when you are approaching and passing through intersections, since intersections are the most likely places for motorcycle accidents to occur.
- c. Ride where other motorists can see you. Avoid riding in another motorist's blind spot.

4. Many accidents involve inexperienced operators. In fact, many operators who have been involved in accidents do not even have a current motorcycle license.
  - a. Make sure that you are qualified and that you only lend your motorcycle to other qualified operators.
  - b. Know your skills and limits. Staying within your limits may help you to avoid an accident.
  - c. We recommend that you practice riding your motorcycle where there is no traffic until you have become thoroughly familiar with the motorcycle and all of its controls.
5. Many accidents have been caused by error of the motorcycle operator. A typical error made by the operator is veering wide on a turn due to EXCESSIVE SPEED or undercornering (insufficient lean angle for the speed).
  - a. Always obey the speed limit and never travel faster than warranted by road and traffic conditions.
  - b. Always signal before turning or changing lanes. Make sure that other motorists can see you.
6. The posture of the operator and passenger is important for proper control.
  - a. The operator should keep both hands on the handlebar and both feet on the operator footrests during operation to maintain control of the motorcycle.
  - b. The passenger should always hold onto the operator, the seat strap or grab bar, if equipped, with both hands and keep both feet on the passenger footrests.
  - c. Never carry a passenger unless he or she can firmly place both feet on the passenger footrests.
7. Never ride under the influence of alcohol or other drugs.
8. This motorcycle is designed for on-road use only. It is not suitable for off-road use.

# SAFETY INFORMATION

---

## Protective apparel

The majority of fatalities from motorcycle accidents are the result of head injuries. The use of a safety helmet is the single most critical factor in the prevention or reduction of head injuries.

1. Always wear an approved helmet.
2. Wear a face shield or goggles. Wind in your unprotected eyes could contribute to an impairment of vision that could delay seeing a hazard.
3. The use of a jacket, heavy boots, trousers, gloves, etc., is effective in preventing or reducing abrasions or lacerations.
4. Never wear loose-fitting clothes, otherwise they could catch on the control levers, footrests, or wheels and cause injury or an accident.
5. Never touch the engine or exhaust system during or after operation. They become very hot and can cause burns. Always wear protective clothing that covers your legs, ankles, and feet.
6. A passenger should also observe the above precautions.

## Modifications

Modifications made to this motorcycle not approved by Yamaha, or the removal of original equipment, may render the motorcycle unsafe for use and may cause severe personal injury. Modifications may also make your motorcycle illegal to use.

## Loading and accessories

Adding accessories or cargo to your motorcycle can adversely affect stability and handling if the weight distribution of the motorcycle is changed. To avoid the possibility of an accident, use extreme caution when adding cargo or accessories to your motorcycle. Use extra care when riding a motorcycle that has added cargo or accessories. Here are some general guidelines to follow if loading cargo or adding accessories to your motorcycle:

## Loading

The total weight of the operator, passenger, accessories and cargo must not exceed the maximum load limit of YZF-R1: 201 kg (443 lb)/YZF-R1C: 200 kg (441 lb). When loading within this weight limit, keep the following in mind:

1. Cargo and accessory weight should be kept as low and close to the motorcycle as possible. Make sure to distribute the weight as evenly as possible on both sides of the motorcycle to minimize imbalance or instability.
2. Shifting weights can create a sudden imbalance. Make sure that accessories and cargo are securely attached to the motorcycle before riding. Check accessory mounts and cargo restraints frequently.
3. Never attach any large or heavy items to the handlebar, front fork, or front fender. These items, including such items as sleeping bags, duffel bags, or tents, can create unstable handling or a slow steering response.

## Accessories

Genuine Yamaha accessories have been specifically designed for use on this motorcycle. Since Yamaha cannot test all other accessories that may be available, you must personally be responsible for the proper selection, installation and use of non-Yamaha accessories. Use extreme caution when selecting and installing any accessories.

Keep the following guidelines in mind, as well as those provided under “Loading” when mounting accessories.

1. Never install accessories or carry cargo that would impair the performance of your motorcycle. Carefully inspect the accessory before using it to make sure that it does not in any way reduce ground clearance or cornering clearance, limit suspension travel, steering travel or control operation, or obscure lights or reflectors.
  - a. Accessories fitted to the handlebar or the front fork area can create instability due to improper weight distribution or aerodynamic changes. If accessories are added to the handlebar or front fork area, they must be as lightweight as possible and should be kept to a minimum.

## **SAFETY INFORMATION**

---

- b. Bulky or large accessories may seriously affect the stability of the motorcycle due to aerodynamic effects. Wind may attempt to lift the motorcycle, or the motorcycle may become unstable in cross winds. These accessories may also cause instability when passing or being passed by large vehicles.
  - c. Certain accessories can displace the operator from his or her normal riding position. This improper position limits the freedom of movement of the operator and may limit control ability, therefore, such accessories are not recommended.
2. Use caution when adding electrical accessories. If electrical accessories exceed the capacity of the motorcycle's electrical system, an electric failure could result, which could cause a dangerous loss of lights or engine power.

### **Gasoline and exhaust gas**

1. **GASOLINE IS HIGHLY FLAMMABLE:**
  - a. Always turn the engine off when refueling.
  - b. Take care not to spill any gasoline on the engine or exhaust system when refueling.
  - c. Never refuel while smoking or in the vicinity of an open flame.
2. Never start the engine or let it run for any length of time in a closed area. The exhaust fumes are poisonous and may cause loss of consciousness and death within a short time. Always operate your motorcycle in an area that has adequate ventilation.
3. Always turn the engine off before leaving the motorcycle unattended and remove the key from the main switch. When parking the motorcycle, note the following:
  - a. The engine and exhaust system may be hot, therefore, park the motorcycle in a place where pedestrians or children are not likely to touch these hot areas.
  - b. Do not park the motorcycle on a slope or soft ground, otherwise it may fall over.
  - c. Do not park the motorcycle near a flammable source (e.g., a kerosene heater, or near an open flame), otherwise it could catch fire.

## SAFETY INFORMATION

---

4. When transporting the motorcycle in another vehicle, make sure that it is kept upright. If the motorcycle should lean over, gasoline may leak out of the carburetor or fuel tank.
5. If you should swallow any gasoline, inhale a lot of gasoline vapor, or allow gasoline to get into your eyes, see your doctor immediately. If any gasoline spills on your skin or clothing, immediately wash the affected area with soap and water and change your clothes.

# SAFETY INFORMATION

EAU02977

## Location of important labels

Please read the following important labels carefully before operating this motorcycle.

1

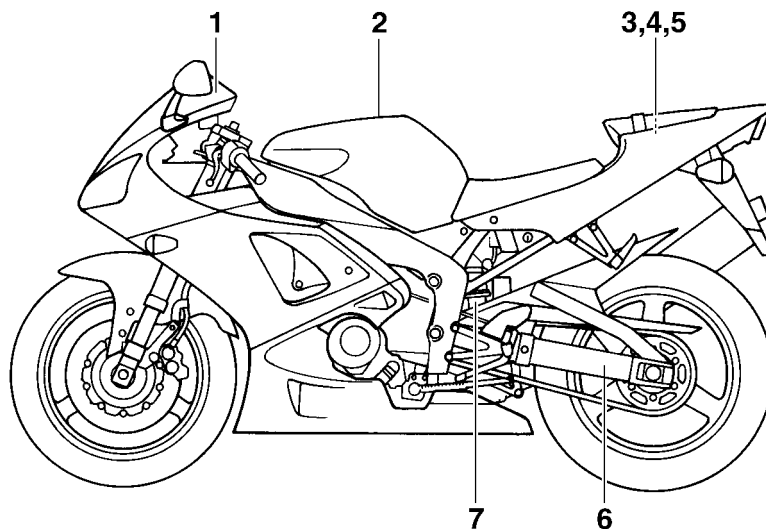

**1**

**CAUTION**

- Cleaning with alkaline or acid cleaner, gasoline or solvent will damage windshield.
- Use neutral detergent.

3JJ-2835Y-A0

**2**

**! WARNING**

- **BEFORE YOU OPERATE THIS VEHICLE, READ THE OWNER'S MANUAL AND ALL LABELS.**
- **ALWAYS WEAR AN APPROVED MOTORCYCLE HELMET**, eye protection, and protective clothing.

3MX-2118K-A0

**3**

**! WARNING**

Improper loading can cause loss of control.  
Read owner's manual for proper loading.

3JJ-28446-A0

**LOAD LIMIT**

3 Kg {7 lbs}

3TB-24877-A0

**5**

**California only**

**EMISSION HOSE ROUTING**

CARB.  
FROM FUEL TANK  
CANISTER  
TO ATMOSPHERE

4YN-21686-00

**6**

**TIRE INFORMATION**

Cold tire normal pressure should be set as follows.

- Up to 90 kg (198 lbs) load

**FRONT** : 250 kPa, (2.50 kgf/cm<sup>2</sup>), 36 psi  
**REAR** : 250 kPa, (2.50 kgf/cm<sup>2</sup>), 36 psi

- 90 kg (198 lbs) ~ maximum load

**FRONT** : 250 kPa, (2.50 kgf/cm<sup>2</sup>), 36 psi  
**REAR** : 290 kPa, (2.90 kgf/cm<sup>2</sup>), 42 psi

4XV-21668-00

**7**

**! WARNING**

This unit contains high pressure nitrogen gas. Mishandling can cause explosion.

- Read owner's manual for instructions.
- Do not incinerate, puncture or open.

4AA-22259-80

1



## DESCRIPTION

Left view .....	2-1
Right view .....	2-2
Controls and instruments .....	2-3

## Left view

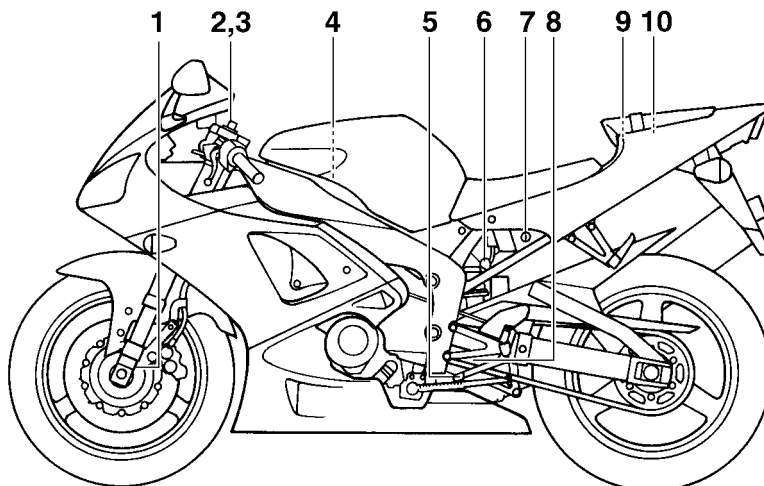

- |   |             |
|---|-------------|
| 1. Front fork compression damping force adjusting screw     | (page 3-16) |
| 2. Front fork rebound damping force adjusting screw         | (page 3-16) |
| 3. Front fork spring preload adjusting bolt                 | (page 3-15) |
| 4. Air filter element                                       | (page 6-19) |
| 5. Shift pedal  | (page 3-9)  |
| 6. Shock absorber compression damping force adjusting screw | (page 3-18) |
| 7. Passenger seat lock                                      | (page 3-13) |
| 8. Shock absorber rebound damping force adjusting screw     | (page 3-17) |
| 9. Luggage strap holders                                    | (page 3-20) |
| 10. Helmet holders  | (page 3-13) |

## Right view

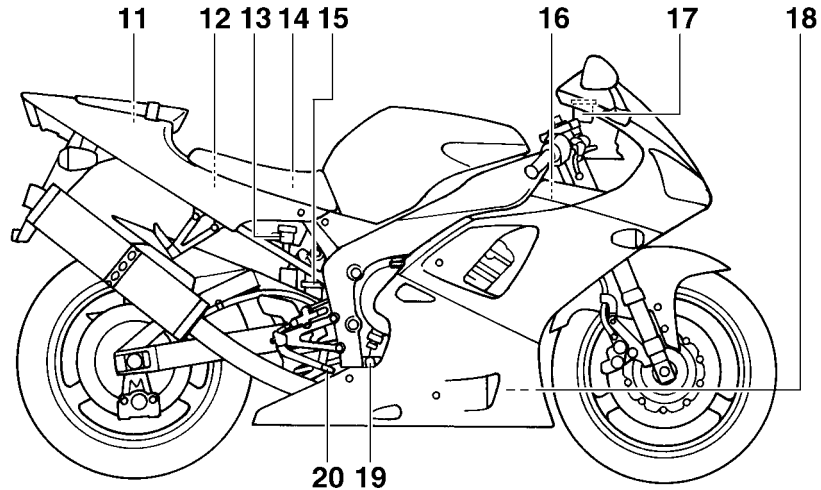

- |   |             |                                    |             |
|---|-------------|------------------------------------|-------------|
| 11. Owner's tool kit                                | (page 6-1)  | 16. Radiator and coolant reservoir | (page 6-15) |
| 12. Fuses   | (page 6-39) | 17. Front brake fluid reservoir    | (page 6-29) |
| 13. Rear brake fluid reservoir                      | (page 6-29) | 18. Engine oil filter cartridge    | (page 6-12) |
| 14. Battery   | (page 6-38) | 19. Engine oil level check window  | (page 6-12) |
| 15. Shock absorber spring preload<br>adjusting ring | (page 3-17) | 20. Brake pedal                    | (page 3-10) |

# DESCRIPTION

## Controls and instruments

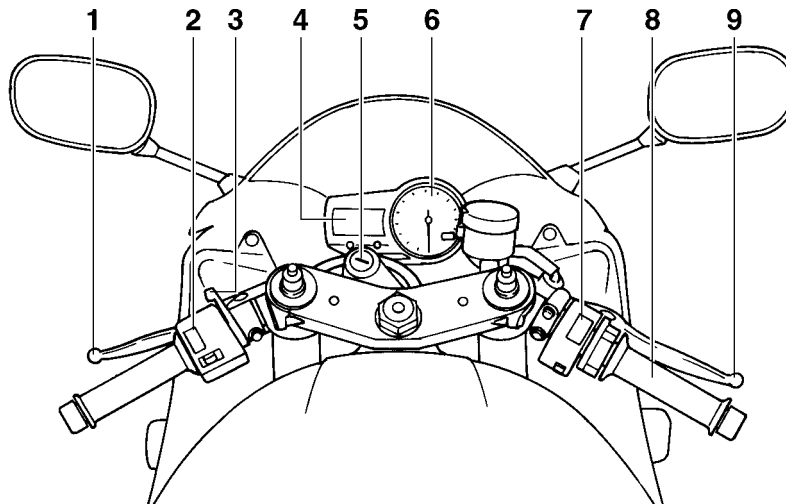

- 1. Clutch lever
- 2. Left handlebar switches
- 3. Starter (choke) lever
- 4. Speedometer unit
- 5. Main switch/steering lock

- (page 3-9)
- (page 3-7)
- (page 3-12)
- (page 3-5)
- (page 3-1)

- 6. Tachometer
- 7. Right handlebar switches
- 8. Throttle grip
- 9. Brake lever

- (page 3-6)
- (page 3-8)
- (page 6-21)
- (page 3-9)

# INSTRUMENT AND CONTROL FUNCTIONS

Main switch/steering lock .....	3-1	Starter (choke) lever .....	3-12
Indicator and warning lights .....	3-2	Seats .....	3-12
Speedometer unit .....	3-5	Helmet holders .....	3-13
Tachometer .....	3-6	Storage compartment .....	3-14
Self-diagnosis devices .....	3-7	Adjusting the front fork .....	3-15
Handlebar switches .....	3-7	Adjusting the shock absorber assembly .....	3-17
Clutch lever .....	3-9	Matching the front and rear suspension settings .....	3-19
Shift pedal .....	3-9	Luggage strap holders .....	3-20
Brake lever .....	3-9	EXUP system .....	3-20
Brake pedal .....	3-10	Sidestand .....	3-21
Fuel tank cap .....	3-10	Ignition circuit cut-off system .....	3-21
Fuel .....	3-11		

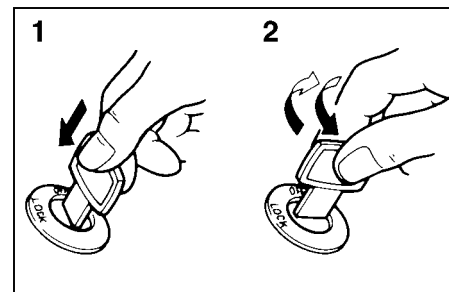
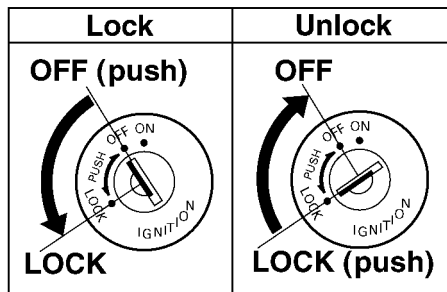
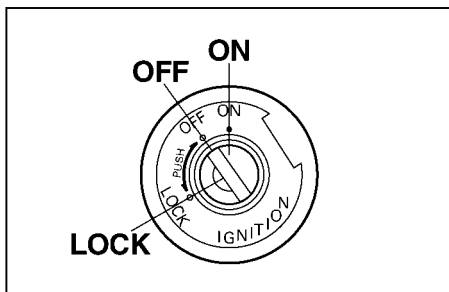

1. Push.
2. Turn.

## Main switch/steering lock

The main switch/steering lock controls the ignition and lighting systems, and is used to lock the steering. The various positions are described below.

### ON

All electrical systems are supplied with power, and the headlight, meter lighting, taillight and position lights come on, and the engine can be started. The key cannot be removed.

### OFF

All electrical systems are off. The key can be removed.

### LOCK

The steering is locked, and all electrical systems are off. The key can be removed.

#### To lock the steering

1. Turn the handlebars all the way to the left.
2. Push the key in from the "OFF" position, and then turn it to "LOCK" while still pushing it.
3. Remove the key.

#### To unlock the steering

Push the key in, and then turn it to "OFF" while still pushing it.

## ⚠ WARNING

Never turn the key to "OFF" or "LOCK" while the motorcycle is moving, otherwise the electrical systems will be switched off, which may result in loss of control or an accident. Make sure that the motorcycle is stopped before turning the key to "OFF" or "LOCK".

# INSTRUMENT AND CONTROL FUNCTIONS

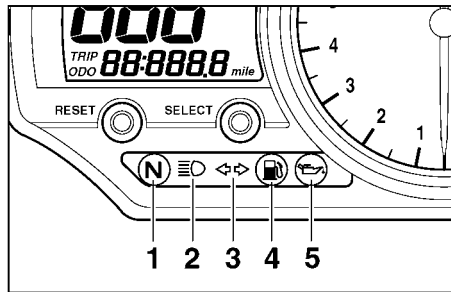

1. Neutral indicator light “N”
2. High beam indicator light “≡”
3. Turn signal indicator light “↔”
4. Fuel level warning light “⛽”
5. Oil level warning light “🛢️”

## Indicator and warning lights

EAU03034

### Neutral indicator light “N”

EAU00061

This indicator light comes on when the transmission is in the neutral position.

### High beam indicator light “≡”

EAU00063

This indicator light comes on when the high beam of the headlight is switched on.

### Turn signal indicator light “↔”

EAU00057

This indicator light flashes when the turn signal switch is pushed to the left or right.

### Fuel level warning light “⛽”

EAU03284

This warning light comes on when the fuel level drops below approximately 3.8 L (0.84 Imp gal, 1.00 US gal). When this occurs, refuel as soon as possible.

The electrical circuit of the warning light can be checked according to the following procedure.

1. Turn the key to “ON”.
2. If the warning light does not come on, have a Yamaha dealer check the electrical circuit.

### NOTE:

This model is equipped with a self-diagnosis device for the fuel level warning light circuit. (See page 3-7 for an explanation of the self-diagnosis device.)

### Oil level warning light “🛢️”

EAU03285

This warning light comes on when the engine oil level is low.

The electrical circuit of the warning light can be checked according to the following procedure.

1. Turn the key to “ON”.
2. If the warning light does not come on, have a Yamaha dealer check the electrical circuit.

### NOTE:

Even if the oil level is sufficient, the warning light may flicker when riding on a slope or during sudden acceleration or deceleration, but this is not a malfunction.

# INSTRUMENT AND CONTROL FUNCTIONS

EC000002

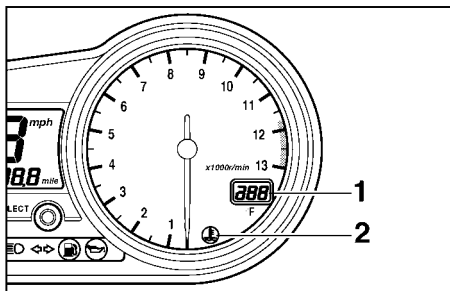

## CAUTION:

Do not operate the engine if it is overheated.

1. Coolant temperature gauge
2. Coolant temperature warning light “”

EAU03205

## Coolant temperature warning light “”

This warning light comes on when the engine overheats. When this occurs, stop the engine immediately and allow the engine to cool.

The electrical circuit of the warning light can be checked according to the following procedure.

1. Turn the key to “ON”.
2. If the warning light does not come on, have a Yamaha dealer check the electrical circuit.

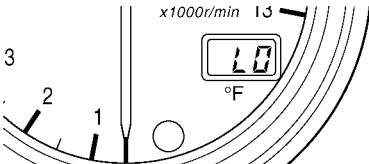
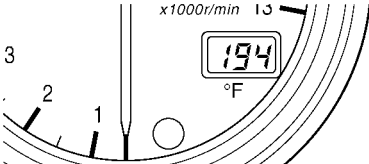
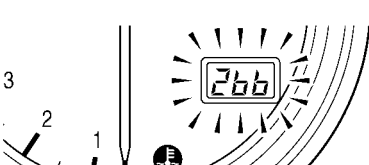
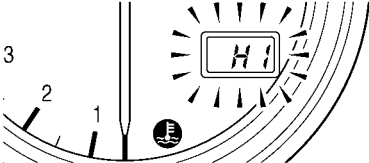

# INSTRUMENT AND CONTROL FUNCTIONS

Coolant temperature	Display	Conditions	What to do
0–103°F	 <p>The image shows a coolant temperature gauge with a needle pointing to 0 on a scale from 0 to 3. A digital display shows 'LO'. The gauge is labeled 'x1000r/min 13' and '°F'.</p>	Message "LO" is displayed.	OK. Go ahead with riding.
104–241°F	 <p>The image shows a coolant temperature gauge with a needle pointing to approximately 1.5 on a scale from 0 to 3. A digital display shows '194'. The gauge is labeled 'x1000r/min 13' and '°F'.</p>	Temperature is displayed.	OK. Go ahead with riding.
242–283°F	 <p>The image shows a coolant temperature gauge with a needle pointing to approximately 2.5 on a scale from 0 to 3. A digital display shows '266' with a flashing effect. A warning light is illuminated. The gauge is labeled 'x1000r/min 13' and '°F'.</p>	Temperature flashes. Warning light comes on.	Stop the motorcycle and allow it to idle until the coolant temperature goes down. If the temperature does not go down, stop the engine. (See the "Engine overheating" section on page 6-49 for further instructions.)
Above 284°F	 <p>The image shows a coolant temperature gauge with a needle pointing to approximately 3.0 on a scale from 0 to 3. A digital display shows 'HI' with a flashing effect. A warning light is illuminated. The gauge is labeled 'x1000r/min 13' and '°F'.</p>	Message "HI" flashes. Warning light comes on.	Stop the engine and allow it to cool. (See the "Engine overheating" section on page 6-49 for further instructions.)

# INSTRUMENT AND CONTROL FUNCTIONS

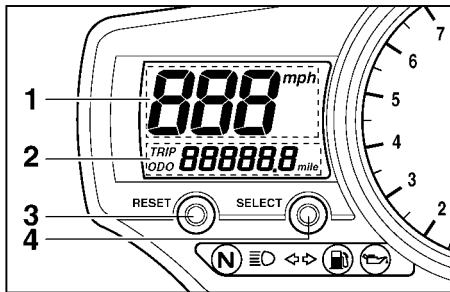

1. Speedometer
2. Odometer/tripmeter/fuel reserve tripmeter/  
clock
3. "RESET" button
4. "SELECT" button

EAU03255

## Speedometer unit

The speedometer unit is equipped with the following:

- a digital speedometer (which shows riding speed)
- an odometer (which shows the total distance traveled)
- two tripmeters (which show the distance traveled since they were last set to zero)
- a fuel reserve tripmeter (which shows the distance traveled on the fuel reserve)

- a clock

**NOTE:** \_\_\_\_\_  
To switch the speedometer display between kilometers and miles, press the "SELECT" button and "RESET" button together for at least two seconds.

## Odometer and tripmeter modes

Pushing the "SELECT" button switches the display between the odometer mode "ODO" and the tripmeter modes "TRIP 1" and "TRIP 2" in the following order:  
ODO → TRIP 1 → TRIP 2 → ODO

If the fuel level warning light comes on (see page 3-2), the odometer display will automatically change to the fuel reserve tripmeter mode "TRIP F" and start counting the distance traveled from that point. In that case, pushing the "SELECT" button switches the display between the various tripmeter and odometer modes in the following order:  
TRIP F → TRIP 1 → TRIP 2 → ODO → TRIP F

To reset a tripmeter, select it by pushing the "SELECT" button, and then push the "RESET" button for at least one second. If you do not reset the fuel reserve tripmeter manually, it will reset itself automatically and the display will return to the prior mode after refueling and traveling 5 km (3 mi).

# INSTRUMENT AND CONTROL FUNCTIONS

## Clock mode

To change the display to the clock mode, push the “SELECT” button for at least one second.

To change the display back to the prior mode, push the “SELECT” button.

To set the clock:

1. Push the “SELECT” button and “RESET” button together for at least two seconds.
2. When the hour digits start flashing, push the “RESET” button to set the hours.
3. Push the “SELECT” button, and the minute digits will start flashing.
4. Push the “RESET” button to set the minutes.
5. Push the “SELECT” button and then release it to start the clock.

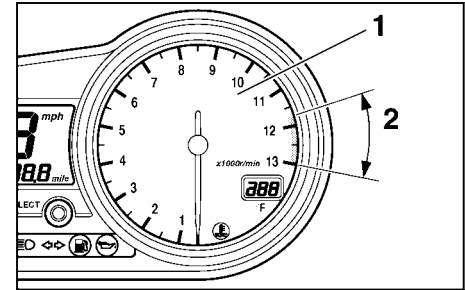

1. Tachometer
2. Red zone

EAU00101

## Tachometer

The electric tachometer allows the rider to monitor the engine speed and keep it within the ideal power range.

EC000003

### CAUTION:

**Do not operate the engine in the tachometer red zone.**

**Red zone: 11,750 r/min and above**

# INSTRUMENT AND CONTROL FUNCTIONS

EAU03271

## Self-diagnosis devices

This model is equipped with a self-diagnosis device for the following electrical circuits:

- throttle position sensor
- speed sensor
- EXUP system

If any of those circuits are defective, the tachometer will repeatedly display the following error code:

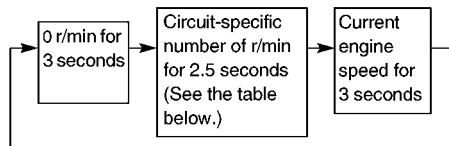

Use the chart below to identify the faulty electrical circuit.

Specific r/min	Faulty electrical circuit
3,000 r/min	Throttle position sensor
4,000 r/min	Speed sensor
7,000 r/min	EXUP system

If the tachometer displays such an error code, note the circuit-specific number of r/min, and then have a Yamaha dealer check the motorcycle.

EC000004

### CAUTION:

**When the tachometer displays an error code, the motorcycle should be checked as soon as possible in order to avoid engine damage.**

This model is also equipped with a self-diagnosis device for the fuel level warning light circuit. If the fuel level warning light circuit is defective, the following cycle will be repeated until the malfunction is corrected: The warning light will flash eight times, then go off for three seconds. If this occurs, have a Yamaha dealer check the motorcycle.

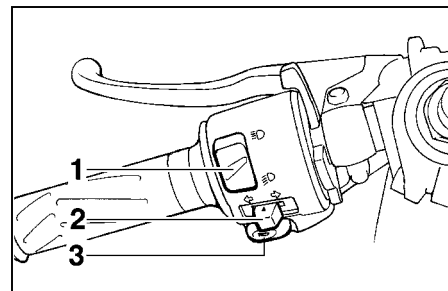



1. Dimmer switch
2. Turn signal switch
3. Horn switch “”

EAU00118

## Handlebar switches

EAU00121



### Dimmer switch

Set this switch to “” for the high beam and to “” for the low beam.

# INSTRUMENT AND CONTROL FUNCTIONS

## Turn signal switch

EAU00127

To signal a right-hand turn, push this switch to “”. To signal a left-hand turn, push this switch to “”. When released, the switch returns to the center position. To cancel the turn signal lights, push the switch in after it has returned to the center position.

## Horn switch “”

EAU00129

Press this switch to sound the horn.

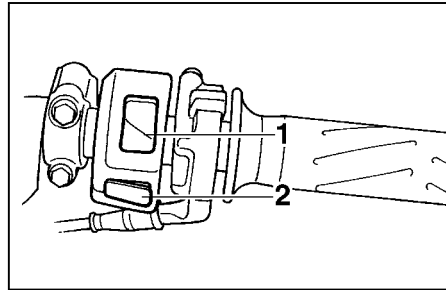

1. Engine stop switch
2. Start switch “”

EAU00138

## Engine stop switch

Set this switch to “” to stop the engine in case of an emergency, such as when the motorcycle overturns or when the throttle cable is stuck.

## Start switch “”

EAU00143

Push this switch to crank the engine with the starter.

EC000005

### CAUTION:

**See page 5-1 for starting instructions prior to starting the engine.**

# INSTRUMENT AND CONTROL FUNCTIONS

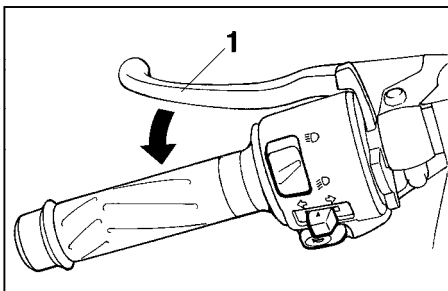

1. Clutch lever

EAU00152

## Clutch lever

The clutch lever is located at the left handlebar grip. To disengage the clutch, pull the lever toward the handlebar grip. To engage the clutch, release the lever. The lever should be pulled rapidly and released slowly for smooth clutch operation.

The clutch lever is equipped with a clutch switch, which is part of the ignition circuit cut-off system. (See page 3-21 for an explanation of the ignition circuit cut-off system.)

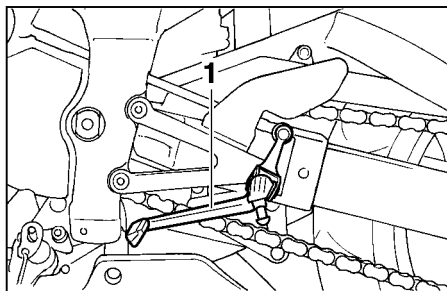

1. Shift pedal

EAU00157

## Shift pedal

The shift pedal is located on the left side of the engine and is used in combination with the clutch lever when shifting the gears of the 6-speed constant-mesh transmission equipped on this motorcycle.

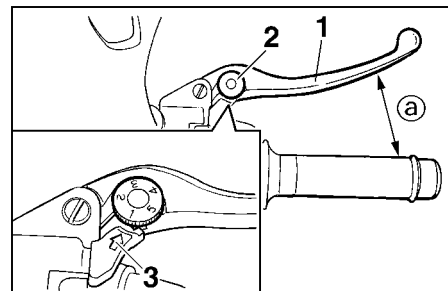

1. Brake lever

2. Brake lever position adjusting dial

3. Arrow mark

a. Distance between brake lever and handlebar

EAU00161

## Brake lever

The brake lever is located at the right handlebar grip. To apply the front brake, pull the lever toward the handlebar grip. The brake lever is equipped with a position adjusting dial. To adjust the distance between the brake lever and the handlebar grip, turn the adjusting dial while holding the lever pushed away from the handlebar grip. Make sure that the appropriate setting on the adjusting dial is aligned with the arrow mark on the brake lever.

# INSTRUMENT AND CONTROL FUNCTIONS

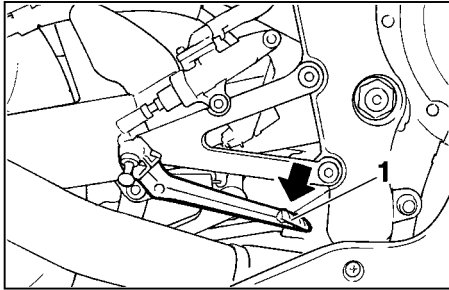

1. Brake pedal

EAU00162

## Brake pedal

The brake pedal is on the right side of the motorcycle. To apply the rear brake, press down on the brake pedal.

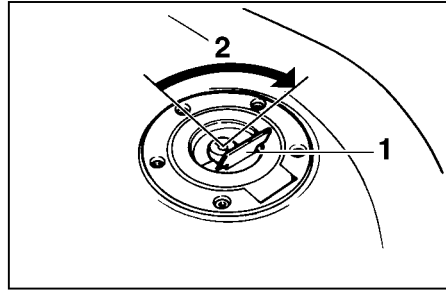

1. Fuel tank cap lock cover
2. Unlock.

EAU02935

## Fuel tank cap

### To open the fuel tank cap

Open the fuel tank cap lock cover, insert the key into the lock, and then turn it 1/4 turn clockwise. The lock will be released and the fuel tank cap can be opened.

### To close the fuel tank cap

1. Push the fuel tank cap into position with the key inserted in the lock.

2. Turn the key counterclockwise to the original position, remove it, and then close the lock cover.

### NOTE:

The fuel tank cap cannot be closed unless the key is in the lock. In addition, the key cannot be removed if the cap is not properly closed and locked.

EWA00025

### **WARNING**

**Make sure that the fuel tank cap is properly closed before riding.**

# INSTRUMENT AND CONTROL FUNCTIONS

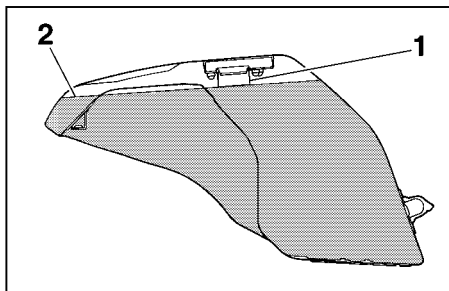

1. Fuel tank filler tube
2. Fuel level

EAU001183

## Fuel

Make sure that there is sufficient fuel in the tank. Fill the fuel tank to the bottom of the filler tube as shown in the illustration.

EW000130

### **WARNING**

- Do not overfill the fuel tank, otherwise it may overflow when the fuel warms up and expands.
- Avoid spilling fuel on the hot engine.

EAU00185

### **CAUTION:**

Immediately wipe off spilled fuel with a clean, dry, soft cloth, since fuel may deteriorate painted surfaces or plastic parts.

EAU00189

Recommended fuel:

**UNLEADED FUEL**

Fuel tank capacity:

Total amount:

18 L (3.96 Imp gal, 4.76 US gal)

Reserve amount:

3.8 L (0.84 Imp gal, 1.00 US gal)

Your Yamaha engine has been designed to use regular unleaded gasoline with a pump octane number  $[(R+M)/2]$  of 86 or higher, or a research octane number of 91 or higher. If knocking (or pinging) occurs, use a gasoline of a different brand or premium unleaded fuel. Use of unleaded fuel will extend spark plug life and reduce maintenance costs. If unleaded gasoline is not available, then leaded regular gasoline can be used.

## Gasohol

There are two types of gasohol: gasohol containing ethanol and that containing methanol. Gasohol containing ethanol can be used if the ethanol content does not exceed 10%. Gasohol containing methanol is not recommended by Yamaha because it can cause damage to the fuel system or vehicle performance problems.



# INSTRUMENT AND CONTROL FUNCTIONS

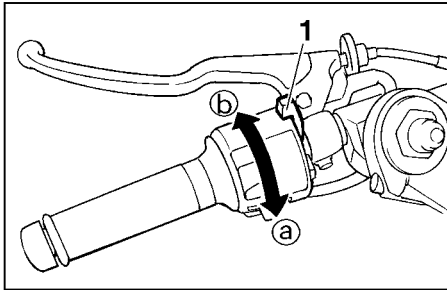

1. Starter (choke) lever

EAU02976

## Starter (choke) lever

Starting a cold engine requires a richer air-fuel mixture, which is supplied by the starter (choke).

Move the lever in direction **a** to turn on the starter (choke).

Move the lever in direction **b** to turn off the starter (choke).

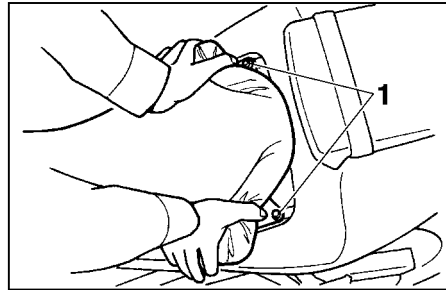

1. Bolt (x 2)

EAU01890

## Seats

### Rider seat

#### To remove the rider seat

Lift up the rear corners of the rider seat as shown, remove the bolts, and then pull the seat off.

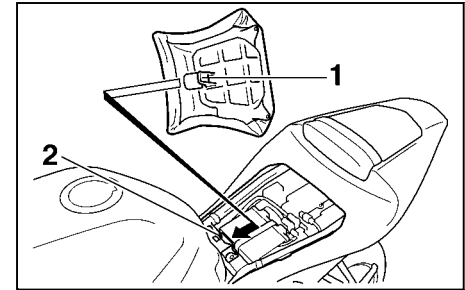

1. Projection

2. Seat holder

#### To install the rider seat

Insert the projection on the front of the rider seat into the seat holder as shown, place the seat in the original position, and then install the bolts.

# INSTRUMENT AND CONTROL FUNCTIONS

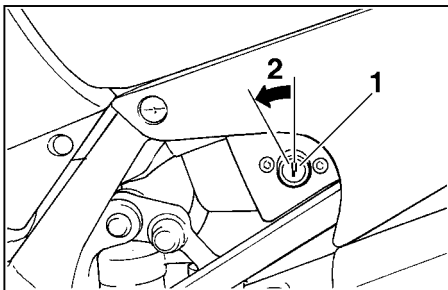

1. Passenger seat lock
2. Unlock.

## Passenger seat

### To remove the passenger seat

1. Insert the key into the seat lock, and then turn it counterclockwise.
2. While holding the key in that position, lift the front of the passenger seat and pull it forward.

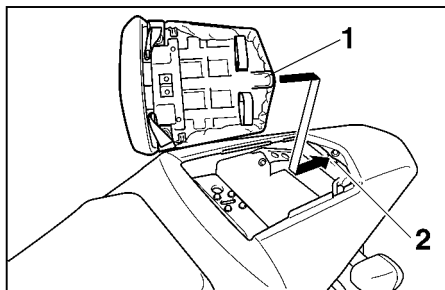

1. Projection
2. Seat holder

### To install the passenger seat

1. Insert the projection on the rear of the passenger seat into the seat holder as shown, and then push the front of the seat down to lock it in place.
2. Remove the key.

**NOTE:** \_\_\_\_\_  
Make sure that the seats are properly secured before riding.  
\_\_\_\_\_

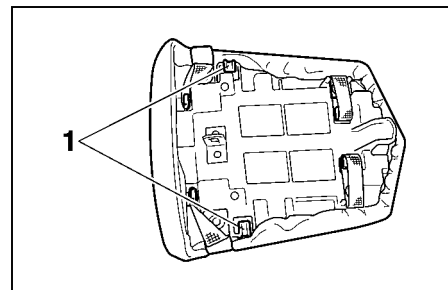

1. Helmet holder (× 2)

EAU03159\*

## Helmet holders

The helmet holders are located on the bottom of the passenger seat.

### **To secure a helmet to a helmet holder**

1. Remove the passenger seat. (See above for removal and installation procedures.)
2. Attach the helmet to a helmet holder, and then securely install the passenger seat.

# INSTRUMENT AND CONTROL FUNCTIONS

EWA00015

## **! WARNING**

Never ride with a helmet attached to a helmet holder, since the helmet may hit objects, causing loss of control and possibly an accident.

### **To release the helmet from a helmet holder**

Remove the passenger seat, remove the helmet from the helmet holder, and then install the seat.

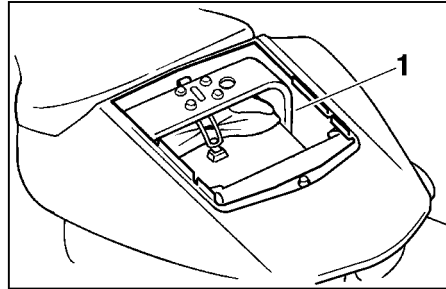

1. Storage compartment

EAU01242

### **Storage compartment**

The storage compartment is located under the passenger seat. (See page 3-13 for passenger seat opening and closing procedures.)

EWA00005

## **! WARNING**

- Do not exceed the load limit of 3 kg (7 lb) for the storage compartment.
- Do not exceed the maximum load of YZF-R1: 201 kg (443 lb)/ YZF-R1C: 200 kg (441 lb) for the vehicle.

# INSTRUMENT AND CONTROL FUNCTIONS

EAU01862

## Adjusting the front fork

This front fork is equipped with spring preload adjusting bolts, rebound damping force adjusting screws and compression damping force adjusting screws.

EW000035

3

### **WARNING**

**Always adjust both fork legs equally, otherwise poor handling and loss of stability may result.**

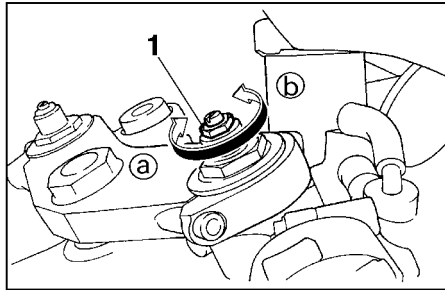

1. Spring preload adjusting bolt

### Spring preload

To increase the spring preload and thereby harden the suspension, turn the adjusting bolt on each fork leg in direction ①. To decrease the spring preload and thereby soften the suspension, turn the adjusting bolt on each fork leg in direction ②.

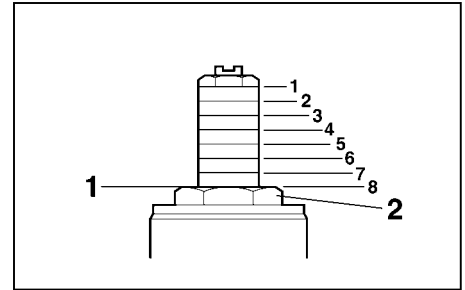

1. Current setting  
2. Front fork cap bolt

**NOTE:** Align the appropriate groove on the adjusting mechanism with the top of the front fork cap bolt.

	Minimum (soft)		Standard	Maximum (hard)				
Setting	8	7	6	5	4	3	2	1

# INSTRUMENT AND CONTROL FUNCTIONS

EC000015

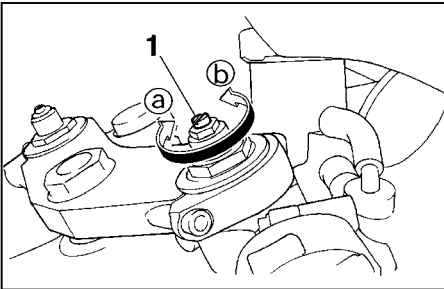

1. Rebound damping force adjusting screw

## Rebound damping force

To increase the rebound damping force and thereby harden the rebound damping, turn the adjusting screw on each fork leg in direction (a). To decrease the rebound damping force and thereby soften the rebound damping, turn the adjusting screw on each fork leg in direction (b).

Minimum (soft)	11 clicks in direction (b)*
Standard	5 clicks in direction (b)*
Maximum (hard)	1 click in direction (b)*

\* With the adjusting screw fully turned in direction (a)

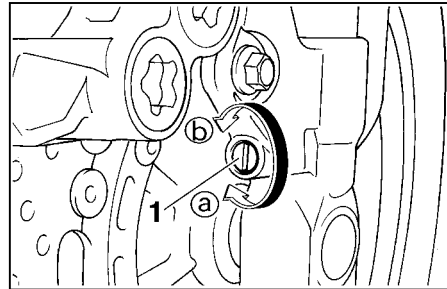

1. Compression damping force adjusting screw

## Compression damping force

To increase the compression damping force and thereby harden the compression damping, turn the adjusting screw on each fork leg in direction (a). To decrease the compression damping force and thereby soften the compression damping, turn the adjusting screw on each fork leg in direction (b).

Minimum (soft)	9 clicks in direction (b)*
Standard	5 clicks in direction (b)*
Maximum (hard)	1 click in direction (b)*

\* With the adjusting screw fully turned in direction (a)

## CAUTION:

Never attempt to turn an adjusting mechanism beyond the maximum or minimum settings.

## NOTE:

Although the total number of clicks of a damping force adjusting mechanism may not exactly match the above specifications due to small differences in production, the actual number of clicks always represents the entire adjusting range. To obtain a precise adjustment, it would be advisable to check the number of clicks of each damping force adjusting mechanism and to modify the specifications as necessary.

# INSTRUMENT AND CONTROL FUNCTIONS

EAU01570

## Adjusting the shock absorber assembly

This shock absorber assembly is equipped with a spring preload adjusting ring and rebound and compression damping force adjusting screws.

EG000015

### CAUTION:

**Never attempt to turn an adjusting mechanism beyond the maximum or minimum settings.**

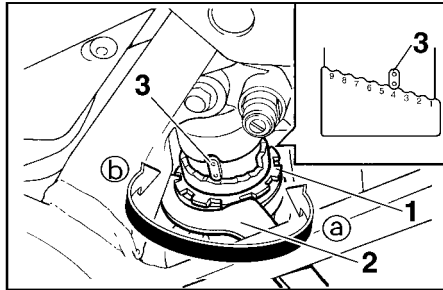

1. Spring preload adjusting ring
2. Special wrench
3. Position indicator

### Spring preload

To increase the spring preload and thereby harden the suspension, turn the adjusting ring in direction (a). To decrease the spring preload and thereby soften the suspension, turn the adjusting ring in direction (b).

### NOTE:

Align the appropriate notch in the adjusting ring with the position indicator on the shock absorber.

	Minimum (soft)			Standard	Maximum (hard)				
Setting	1	2	3	4	5	6	7	8	9

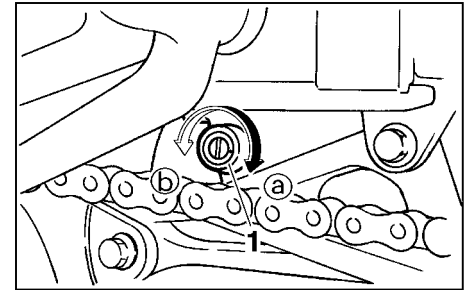

1. Rebound damping force adjusting screw

### Rebound damping force

To increase the rebound damping force and thereby harden the rebound damping, turn the adjusting screw in direction (a). To decrease the rebound damping force and thereby soften the rebound damping, turn the adjusting screw in direction (b).

Minimum (soft)	11 clicks in direction (b)*
Standard	7 clicks in direction (b)*
Maximum (hard)	1 click in direction (b)*

\* With the adjusting screw fully turned in direction (a)

# INSTRUMENT AND CONTROL FUNCTIONS

EAU00315

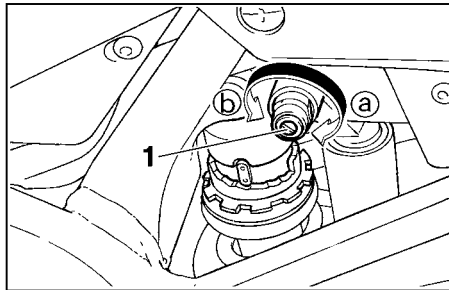

1. Compression damping force adjusting screw

## Compression damping force

To increase the compression damping force and thereby harden the compression damping, turn the adjusting screw in direction ①. To decrease the compression damping force and thereby soften the compression damping, turn the adjusting screw in direction ②.

Minimum (soft)	11 clicks in direction ②*
Standard	9 clicks in direction ②*
Maximum (hard)	1 click in direction ②*

\* With the adjusting screw fully turned in direction ③

## NOTE:

Although the total number of clicks of a damping force adjusting mechanism may not exactly match the above specifications due to small differences in production, the actual number of clicks always represents the entire adjusting range. To obtain a precise adjustment, it would be advisable to check the number of clicks of each damping force adjusting mechanism and to modify the specifications as necessary.

## ⚠ WARNING

This shock absorber contains highly pressurized nitrogen gas. For proper handling, read and understand the following information before handling the shock absorber. The manufacturer cannot be held responsible for property damage or personal injury that may result from improper handling.

- Do not tamper with or attempt to open the gas cylinder.
- Do not subject the shock absorber to an open flame or other high heat sources, otherwise it may explode due to excessive gas pressure.
- Do not deform or damage the gas cylinder in any way, as this will result in poor damping performance.
- Always have a Yamaha dealer service the shock absorber.

# INSTRUMENT AND CONTROL FUNCTIONS

EAU01580

## Matching the front and rear suspension settings

Use this table as a guide to match the suspension and damping adjustments of the front fork and shock absorber assembly according to various load conditions.

Load condition	Front fork adjustment			Shock absorber assembly adjustment		
	Spring preload	Compression damping force	Rebound damping force	Spring preload	Compression damping force	Rebound damping force
Rider only	1–8	1–9	1–11	1–7	4–11	3–11
With passenger	1–8	1–9	1–11	4–9	1–9	1–7

EC000015

### CAUTION:

**Never attempt to turn an adjusting mechanism beyond the maximum or minimum settings.**



EAU01571

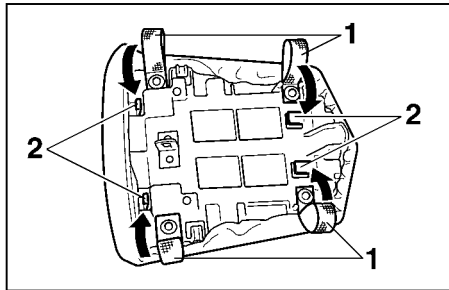

1. Luggage strap holder (× 4)
2. Hook (× 4)

EAU03170

## Luggage strap holders

There are four luggage strap holders on the bottom of the passenger seat. To use the strap holders, remove the passenger seat, unhook the straps, and then install the seat with the straps hanging out from under the passenger seat. (See page 3-13 for passenger seat removal and installation procedures.)

## EXUP system

This motorcycle is equipped with Yamaha's EXUP (EXhaust Ultimate Power valve) system. This system boosts engine power by means of a valve that regulates the diameter of the exhaust pipe. The EXUP system valve is constantly adjusted in accordance with the engine speed by a computer-controlled servomotor.

EC000027

### CAUTION:

- The EXUP system has been set and extensively tested at the Yamaha factory. Changing these settings without sufficient technical knowledge may result in poor performance of or damage to the engine.
- If the EXUP system does not operate, have a Yamaha dealer check it.

# INSTRUMENT AND CONTROL FUNCTIONS

EAU00330

## Sidestand

The sidestand is located on the left side of the frame. Raise the sidestand or lower it with your foot while holding the motorcycle upright.

### NOTE:

The built-in sidestand switch is part of the ignition circuit cut-off system, which cuts the ignition in certain situations. (See further down for an explanation of the ignition circuit cut-off system.)

EW000044

### WARNING

**The motorcycle must not be ridden with the sidestand down, or if the sidestand cannot be properly moved up (or does not stay up), otherwise the sidestand could contact the ground and distract the operator, resulting in a possible loss of control. Yamaha's ignition circuit cut-off system has been designed to assist the operator in fulfilling the responsibility of raising the sidestand before starting off. Therefore, check this system regularly as described below and have a Yamaha dealer repair it if it does not function properly.**

EAU00331

## Ignition circuit cut-off system

The ignition circuit cut-off system (comprising the sidestand switch, clutch switch and neutral switch) has the following functions.

- It prevents starting when the transmission is in gear and the sidestand is up, but the clutch lever is not pulled.
- It prevents starting when the transmission is in gear and the clutch lever is pulled, but the sidestand is still down.
- It cuts the running engine when the sidestand is moved down.

Periodically check the operation of the ignition circuit cut-off system according to the following procedure.

EW000045

### WARNING

**If a malfunction is noted, have a Yamaha dealer check the system before riding.**

# INSTRUMENT AND CONTROL FUNCTIONS

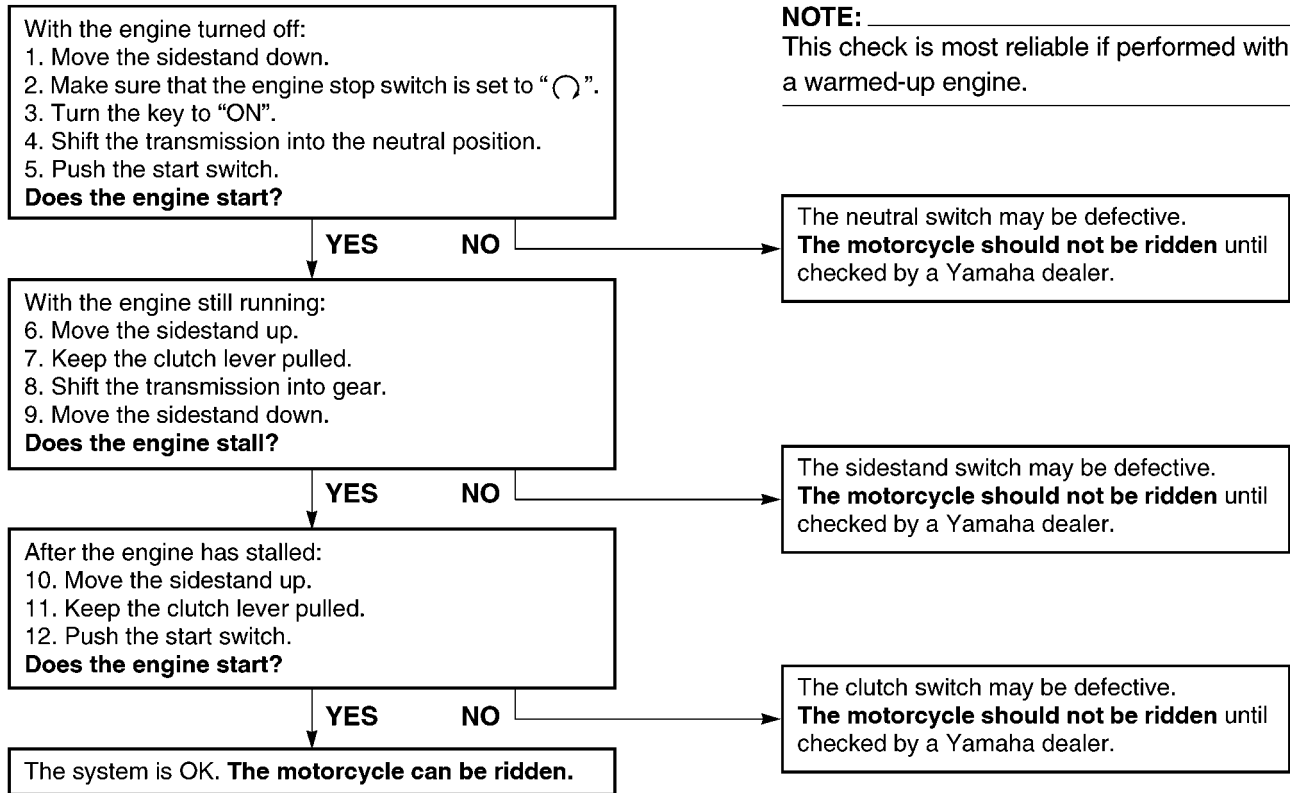



# PRE-OPERATION CHECKS

---

Pre-operation check list ..... 4-1

# PRE-OPERATION CHECKS

EAU01114

The condition of a vehicle is the owner's responsibility. Vital components can start to deteriorate quickly and unexpectedly, even if the vehicle remains unused (for example, as a result of exposure to the elements). Any damage, fluid leakage or loss of tire air pressure could have serious consequences. Therefore, it is very important, in addition to a thorough visual inspection, to check the following points before each ride.

EAU03439

## Pre-operation check list

ITEM	CHECKS	PAGE
<b>Fuel</b>	<ul style="list-style-type: none"><li>• Check fuel level in fuel tank.</li><li>• Refuel if necessary.</li><li>• Check fuel line for leakage.</li></ul>	3-11
<b>Engine oil</b>	<ul style="list-style-type: none"><li>• Check oil level in engine.</li><li>• If necessary, add recommended oil to specified level.</li><li>• Check vehicle for oil leakage.</li></ul>	6-12-6-15
<b>Coolant</b>	<ul style="list-style-type: none"><li>• Check coolant level in reservoir.</li><li>• If necessary, add recommended coolant to specified level.</li><li>• Check cooling system for leakage.</li></ul>	6-15-6-18
<b>Front brake</b>	<ul style="list-style-type: none"><li>• Check operation.</li><li>• If soft or spongy, have Yamaha dealer bleed hydraulic system.</li><li>• Check fluid level in reservoir.</li><li>• If necessary, add recommended brake fluid to specified level.</li><li>• Check hydraulic system for leakage.</li></ul>	6-28-6-30, 6-34
<b>Rear brake</b>	<ul style="list-style-type: none"><li>• Check operation.</li><li>• If soft or spongy, have Yamaha dealer bleed hydraulic system.</li><li>• Check fluid level in reservoir.</li><li>• If necessary, add recommended brake fluid to specified level.</li><li>• Check hydraulic system for leakage.</li></ul>	6-28-6-30, 6-34
<b>Clutch</b>	<ul style="list-style-type: none"><li>• Check operation.</li><li>• Lubricate cable if necessary.</li><li>• Check lever free play.</li><li>• Adjust if necessary.</li></ul>	6-26

4

# PRE-OPERATION CHECKS

ITEM	CHECKS	PAGE
Throttle grip	<ul style="list-style-type: none"> <li>• Make sure that operation is smooth.</li> <li>• Lubricate throttle grip, housing and cables if necessary.</li> <li>• Check free play.</li> <li>• If necessary, have Yamaha dealer make adjustment.</li> </ul>	6-21, 6-33
Control cables	<ul style="list-style-type: none"> <li>• Make sure that operation is smooth.</li> <li>• Lubricate if necessary.</li> </ul>	6-33
Drive chain	<ul style="list-style-type: none"> <li>• Check chain slack.</li> <li>• Adjust if necessary.</li> <li>• Check chain condition.</li> <li>• Lubricate if necessary.</li> </ul>	6-31-6-32
Wheels and tires	<ul style="list-style-type: none"> <li>• Check for damage.</li> <li>• Check tire condition and tread depth.</li> <li>• Check air pressure.</li> <li>• Correct if necessary.</li> </ul>	6-22-6-25
Brake and shift pedals	<ul style="list-style-type: none"> <li>• Make sure that operation is smooth.</li> <li>• Lubricate pedal pivoting points if necessary.</li> </ul>	6-34
Brake and clutch levers	<ul style="list-style-type: none"> <li>• Make sure that operation is smooth.</li> <li>• Lubricate lever pivoting points if necessary.</li> </ul>	6-34
Sidestand	<ul style="list-style-type: none"> <li>• Make sure that operation is smooth.</li> <li>• Lubricate pivot if necessary.</li> </ul>	6-35
Chassis fasteners	<ul style="list-style-type: none"> <li>• Make sure that all nuts, bolts and screws are properly tightened.</li> <li>• Tighten if necessary.</li> </ul>	—
Instruments, lights, signals and switches	<ul style="list-style-type: none"> <li>• Check operation.</li> <li>• Correct if necessary.</li> </ul>	—
Engine stop switch	<ul style="list-style-type: none"> <li>• Check operation.</li> </ul>	3-8
Sidestand switch	<ul style="list-style-type: none"> <li>• Check operation of ignition circuit cut-off system.</li> <li>• If system is defective, have Yamaha dealer check vehicle.</li> </ul>	3-21

# PRE-OPERATION CHECKS

---

---

**NOTE:**

Pre-operation checks should be made each time the motorcycle is used. Such an inspection can be accomplished in a very short time; and the added safety it assures is more than worth the time involved.

---

EWA00033

 **WARNING**

**If any item in the Pre-operation check list is not working properly, have it inspected and repaired before operating the motorcycle.**

---



# OPERATION AND IMPORTANT RIDING POINTS

---

Starting and warming up a cold engine .....	5-1
Starting a warm engine .....	5-3
Shifting .....	5-3
Engine break-in .....	5-5
Parking .....	5-6

EAU00373

EAU00376

EAU01361\*

**! WARNING**

- Become thoroughly familiar with all operating controls and their functions before riding. Consult a Yamaha dealer regarding any control or function that you do not thoroughly understand.
- Never start the engine or operate it in a closed area for any length of time. Exhaust fumes are poisonous, and inhaling them can cause loss of consciousness and death within a short time. Always make sure that there is adequate ventilation.
- Before starting out, make sure that the sidestand is up. If the sidestand is not raised completely, it could contact the ground and distract the operator, resulting in a possible loss of control.

**CAUTION:**

- Make sure not to store personal items near the air cleaner intake, otherwise air intake will be blocked and performance will suffer.
- Make sure not to put anything near the battery and its terminals, otherwise electrical failure and acid corrosion may result.

## Starting and warming up a cold engine

In order for the ignition circuit cut-off system to enable starting, one of the following conditions must be met:

- The transmission is in the neutral position.
- The transmission is in gear with the clutch lever pulled and the sidestand up.

EW000054

**! WARNING**

- Before starting the engine, check the function of the ignition circuit cut-off system according to the procedure described on page 3-22.
- Never ride with the sidestand down.

# OPERATION AND IMPORTANT RIDING POINTS

1. Turn the key to "ON" and make sure that the engine stop switch is set to "○".

ECA00005

## **CAUTION:**

**The oil level/coolant temperature warning light and fuel level warning light should come on for a few seconds, then go off. If a warning light does not go off, see page 3-2 for the corresponding warning light circuit check.**

2. Shift the transmission into the neutral position.

## **NOTE:**

When the transmission is in the neutral position, the neutral indicator light should be on, otherwise have a Yamaha dealer check the electrical circuit.

3. Turn the starter (choke) on and completely close the throttle. (See page 3-12 for starter (choke) operation.)

4. Start the engine by pushing the start switch.

## **NOTE:**

If the engine fails to start, release the start switch, wait a few seconds, and then try again. Each starting attempt should be as short as possible to preserve the battery. Do not crank the engine more than 10 seconds on any one attempt.

5. After starting the engine, move the starter (choke) lever back halfway.

ECA00055

## **CAUTION:**

**For maximum engine life, always warm the engine up before starting off. Never accelerate hard when the engine is cold!**

6. When the engine is warm, turn the starter (choke) off.

## **NOTE:**

The engine is warm when it responds normally to the throttle with the starter (choke) turned off. To avoid the possibility of excessive exhaust emissions, never leave the starter (choke) on longer than necessary. The time necessary for starter (choke) use depends upon the ambient temperature. Temperatures above 10°C (50°F) require about 10 seconds of starter (choke) use and temperatures below 10°C (50°F) require about 35 seconds with the starter (choke) turned on, then about 2.5 minutes with the starter (choke) in the half-way position.

# OPERATION AND IMPORTANT RIDING POINTS

## Starting a warm engine

EAU01258

Follow the same procedure as for starting a cold engine with the exception that the starter (choke) is not required when the engine is warm.

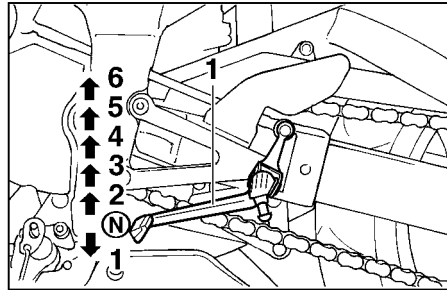

- 1. Shift pedal
- N. Neutral position

EAU00423

## Shifting

Shifting gears lets you control the amount of engine power available for starting off, accelerating, climbing hills, etc.

The gear positions are shown in the illustration.

### NOTE:

To shift the transmission into the neutral position, press the shift pedal down repeatedly until it reaches the end of its travel, and then slightly raise it.

EC000048

### CAUTION:

- Even with the transmission in the neutral position, do not coast for long periods of time with the engine off, and do not tow the motorcycle for long distances. The transmission is properly lubricated only when the engine is running. Inadequate lubrication may damage the transmission.
- Always use the clutch while changing gears to avoid damaging the engine, transmission, and drive train, which are not designed to withstand the shock of forced shifting.

# OPERATION AND IMPORTANT RIDING POINTS

EAU02988\*

EAU00427

EAU02989

## To start out and accelerate

1. Pull the clutch lever to disengage the clutch.
2. Shift the transmission into first gear. The neutral indicator light should go out.
3. Open the throttle gradually, and at the same time, release the clutch lever slowly.
4. At the recommended shift points shown in the following table, close the throttle, and at the same time, quickly pull the clutch lever in.
5. Shift the transmission into second gear. (Make sure not to shift the transmission into the neutral position.)
6. Open the throttle part way and gradually release the clutch lever.
7. Follow the same procedure when shifting to the next higher gear.

### NOTE:

Always shift gears at the recommended shift points.

## To decelerate

1. Apply both the front and the rear brakes to slow the motorcycle.
2. Shift the transmission into first gear when the motorcycle reaches 25 km/h (15.5 mi/h). If the engine is about to stall or runs very roughly, pull the clutch lever in and use the brakes to stop the motorcycle.
3. Shift the transmission into the neutral position when the motorcycle is almost completely stopped. The neutral indicator light should come on.

## Recommended shift points

The recommended shift points during acceleration and deceleration are shown in the table below.

	Acceleration shift point km/h (mi/h)	Deceleration shift point km/h (mi/h)
1st → 2nd	16 (9.9)	—
2nd → 3rd	24 (14.9)	25 (15.5)
3rd → 4th	32 (19.9)	25 (15.5)
4th → 5th	40 (24.9)	25 (15.5)
5th → 6th	48 (29.8)	25 (15.5)

# OPERATION AND IMPORTANT RIDING POINTS

---

## Engine break-in

EAU01128

There is never a more important period in the life of your engine than the period between 0 and 1,600 km (1,000 mi). For this reason, you should read the following material carefully.

Since the engine is brand new, do not put an excessive load on it for the first 1,600 km (1,000 mi). The various parts in the engine wear and polish themselves to the correct operating clearances. During this period, prolonged full-throttle operation or any condition that might result in engine overheating must be avoided.

### 0–1,000 km (0–600 mi)

EAU03172\*

Avoid prolonged operation above 5,000 r/min.

### 1,000–1,600 km (600–1,000 mi)

Avoid prolonged operation above 6,000 r/min.

EC000052\*

#### **CAUTION:** \_\_\_\_\_

**After 1,000 km (600 mi) of operation, the engine oil must be changed and the oil filter cartridge replaced.**

---

### 1,600 km (1,000 mi) and beyond

The vehicle can now be operated normally.

EC000053

#### **CAUTION:** \_\_\_\_\_

- **Keep the engine speed out of the tachometer red zone.**
  - **If any engine trouble should occur during the engine break-in period, immediately have a Yamaha dealer check the vehicle.**
- 

#### **NOTE:** \_\_\_\_\_

During and after the engine break-in period, the exhaust heat may cause discoloration of the exhaust pipe, but this is normal.

---

# OPERATION AND IMPORTANT RIDING POINTS

---

EAU00460

## Parking

When parking, stop the engine, and then remove the key from the main switch.

EW000058

### **WARNING**

- Since the engine and exhaust system can become very hot, park in a place where pedestrians or children are not likely to touch them.
  - Do not park on a slope or on soft ground, otherwise the motorcycle may overturn.
-





# PERIODIC MAINTENANCE AND MINOR REPAIR

PERIODIC MAINTENANCE .....	6-1	Drive chain slack .....	6-31
Owner's tool kit .....	6-1	Lubricating the drive chain .....	6-32
Periodic maintenance chart for the emission control system .....	6-3	Checking and lubricating the cables .....	6-33
General maintenance and lubrication chart .....	6-5	Checking and lubricating the throttle grip and cable .....	6-33
Removing and installing cowlings and panels .....	6-8	Checking and lubricating the brake and clutch levers .....	6-34
Checking the spark plugs .....	6-10	Lubricating the brake pedal .....	6-34
Canister (for California only) .....	6-11	Checking and lubricating the sidestand .....	6-35
Engine oil and oil filter cartridge .....	6-12	Lubricating the rear suspension .....	6-35
Coolant .....	6-15	Checking the front fork .....	6-36
Cleaning the air filter element .....	6-19	Checking the steering .....	6-37
Adjusting the carburetors .....	6-21	Checking the wheel bearings .....	6-37
Adjusting the throttle cable free play .....	6-21	Battery .....	6-38
Adjusting the valve clearance .....	6-21	Replacing the fuses .....	6-39
Tires .....	6-22	Replacing the headlight bulb .....	6-40
Wheels .....	6-25	Replacing the tail/brake light bulb .....	6-41
Accessories and replacement parts .....	6-25	Replacing a turn signal light bulb .....	6-42
Adjusting the clutch lever free play .....	6-26	Supporting the motorcycle .....	6-43
Adjusting the brake pedal position .....	6-27	Front wheel .....	6-43
Adjusting the rear brake light switch .....	6-27	Rear wheel .....	6-45
Checking the front and rear brake pads .....	6-28	Troubleshooting .....	6-47
Checking the brake fluid level .....	6-29	Troubleshooting charts .....	6-48
Changing the brake fluid .....	6-30		

EAU01790

Safety is an obligation of the owner. Periodic inspection, adjustment and lubrication will keep your vehicle in the safest and most efficient condition possible. The most important points of motorcycle inspection, adjustment, and lubrication are explained on the following pages.

**Maintenance, replacement, or repair of the emission control devices and systems may be performed by any repair establishment or individual that is certified (if applicable).**

EW000060

## **⚠ WARNING**

**If you are not familiar with motorcycle maintenance work, have a Yamaha dealer do it for you.**

EAU00467

## PERIODIC MAINTENANCE

PROPER PERIODIC MAINTENANCE OF YOUR MOTORCYCLE IS IMPORTANT IN ORDER TO ENJOY LONG, PLEASURABLE SERVICE. ESPECIALLY IMPORTANT ARE THE MAINTENANCE SERVICES RELATED TO EMISSIONS CONTROL. THESE CONTROLS NOT ONLY FUNCTION TO ENSURE CLEANER AIR, BUT ARE ALSO VITAL TO PROPER ENGINE OPERATION AND MAXIMUM PERFORMANCE. IN THE FOLLOWING PERIODIC MAINTENANCE CHARTS, THE SERVICES RELATED TO EMISSIONS CONTROL ARE GROUPED SEPARATELY. THESE SERVICES REQUIRE SPECIALIZED DATA, KNOWLEDGE, AND EQUIPMENT. YAMAHA DEALERS ARE TRAINED AND EQUIPPED TO PERFORM THESE PARTICULAR SERVICES.

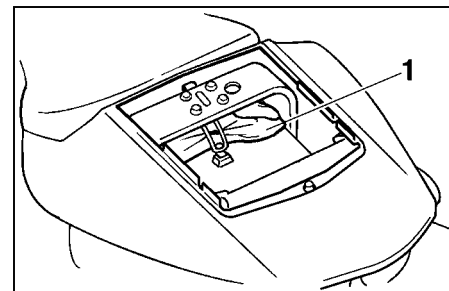

1. Owner's tool kit

EAU01575

## Owner's tool kit

The tool kit is located inside the storage compartment under the passenger seat. (See page 3-13 for passenger seat removal procedures.)

The service information included in this manual and the tools provided in the owner's tool kit are intended to assist you in the performance of preventive maintenance and minor repairs. However, additional tools such as a torque wrench may be necessary to perform certain maintenance work correctly.

# PERIODIC MAINTENANCE AND MINOR REPAIR

---

**NOTE:** \_\_\_\_\_

If you do not have the tools or experience required for a particular job, have a Yamaha dealer perform it for you.

EW000063

**⚠ WARNING** \_\_\_\_\_

**Modifications not approved by Yamaha may cause loss of performance and render the vehicle unsafe for use. Consult a Yamaha dealer before attempting any changes.**

---

# PERIODIC MAINTENANCE AND MINOR REPAIR

EAU00471

## Periodic maintenance chart for the emission control system

No.	ITEM	ROUTINE	INITIAL	ODOMETER READINGS				
			600 mi (1,000 km) or 1 month	4,000mi (7,000 km) or 6 months	8,000 mi (13,000 km) or 12 months	12,000 mi (19,000 km) or 18 months	16,000 mi (25,000 km) or 24 months	20,000 mi (31,000 km) or 30 months
1 *	Valve clearance	<ul style="list-style-type: none"> <li>Check and adjust valve clearance when engine is cold.</li> </ul>	Every 26,600 mi (42,000 km)					
2	Spark plugs	<ul style="list-style-type: none"> <li>Check condition.</li> <li>Adjust gap and clean.</li> <li>Replace every 8,000 mi (13,000 km) or 12 months.</li> </ul>		√	Replace.	√	Replace.	√
3 *	Crankcase ventilation system	<ul style="list-style-type: none"> <li>Check ventilation hose for cracks or damage.</li> <li>Replace if necessary.</li> </ul>		√	√	√	√	√
4 *	Fuel line	<ul style="list-style-type: none"> <li>Check fuel hoses and vacuum hose for cracks or damage.</li> <li>Replace if necessary.</li> </ul>		√	√	√	√	√
5 *	Fuel filter	<ul style="list-style-type: none"> <li>Replace every 20,000 mi (31,000 km) or 30 months.</li> </ul>						Replace.
6 *	Exhaust system	<ul style="list-style-type: none"> <li>Check for leakage.</li> <li>Retighten if necessary.</li> <li>Replace gasket(s) if necessary.</li> </ul>		√	√	√	√	√
7 *	Carburetor synchronization	<ul style="list-style-type: none"> <li>Adjust synchronization of carburetors.</li> </ul>	√	√	√	√	√	√
8 *	Idle speed	<ul style="list-style-type: none"> <li>Check and adjust engine idle speed.</li> <li>Adjust cable free play.</li> </ul>		√	√	√	√	√

# PERIODIC MAINTENANCE AND MINOR REPAIR

No.	ITEM	ROUTINE	INITIAL	ODOMETER READINGS					
			600 mi (1,000 km) or 1 month	4,000mi (7,000 km) or 6 months	8,000 mi (13,000 km) or 12 months	12,000 mi (19,000 km) or 18 months	16,000 mi (25,000 km) or 24 months	20,000 mi (31,000 km) or 30 months	
9 *	<b>Evaporative emission control system (For California only)</b>	<ul style="list-style-type: none"> <li>• Check control system for damage.</li> <li>• Replace if necessary.</li> </ul>				√		√	
10 *	<b>Air induction system</b>	<ul style="list-style-type: none"> <li>• Check the air cut valve and reed valve for damage.</li> <li>• Replace the entire air induction system if necessary.</li> </ul>		√	√	√	√	√	

\* Since these items require special tools, data and technical skills, have a Yamaha dealer perform the service.

# PERIODIC MAINTENANCE AND MINOR REPAIR

EAU00472

## General maintenance and lubrication chart

No.	ITEM	ROUTINE	INITIAL	ODOMETER READINGS					
			600 mi (1,000 km) or 1 month	4,000 mi (7,000 km) or 6 months	8,000 mi (13,000 km) or 12 months	12,000 mi (19,000 km) or 18 months	16,000 mi (25,000 km) or 24 months	20,000 mi (31,000 km) or 30 months	
1	Engine oil	<ul style="list-style-type: none"> <li>Replace (warm engine before draining). (See NOTE on page 6-7.)</li> </ul>	√	√	√	√	√	√	
2 *	Engine oil filter	<ul style="list-style-type: none"> <li>Replace at initial 600 mi (1,000 km) or 1 month, and thereafter every 8,000 mi (13,000 km) or 12 months.</li> </ul>	√		√		√		
3 *	Air filter	<ul style="list-style-type: none"> <li>Clean with compressed air.</li> <li>Replace if necessary.</li> </ul>		√	√	√	√	√	
4 *	Cooling system	<ul style="list-style-type: none"> <li>Check hose for cracks or damage.</li> <li>Replace if necessary.</li> </ul>		√	√	√	√	√	
		<ul style="list-style-type: none"> <li>Replace coolant every 24 months. #3</li> </ul>					<b>Replace.</b>		
5 *	Brake system	<ul style="list-style-type: none"> <li>Check operation, pad wear, and fluid leakage. (See NOTE on page 6-7.)</li> <li>Correct if necessary.</li> </ul>	√	√	√	√	√	√	
6 *	Clutch	<ul style="list-style-type: none"> <li>Check operation.</li> <li>Adjust or replace cable.</li> </ul>	√	√	√	√	√	√	
7 *	Control cable	<ul style="list-style-type: none"> <li>Apply chain lube thoroughly. #1</li> </ul>	√	√	√	√	√	√	
8 *	Swing arm pivot bearing	<ul style="list-style-type: none"> <li>Check bearing assembly for looseness.</li> <li>Moderately repack every 16,000 mi (25,000 km) or 24 months. #2</li> </ul>			√		√	<b>Repack.</b>	
9 *	Rear suspension link pivots	<ul style="list-style-type: none"> <li>Check operation.</li> <li>Correct if necessary.</li> </ul>			√		√		

# PERIODIC MAINTENANCE AND MINOR REPAIR

No.	ITEM	ROUTINE	INITIAL	ODOMETER READINGS					
			600 mi (1,000 km) or 1 month	4,000 mi (7,000 km) or 6 months	8,000 mi (13,000 km) or 12 months	12,000 mi (19,000 km) or 18 months	16,000 mi (25,000 km) or 24 months	20,000 mi (31,000 km) or 30 months	
10	* Rear shock absorber	<ul style="list-style-type: none"> <li>• Check operation and for oil leakage.</li> <li>• Replace if necessary.</li> </ul>		√	√	√	√	√	
11	* Front fork	<ul style="list-style-type: none"> <li>• Check operation and oil leakage.</li> <li>• Repair if necessary.</li> </ul>		√	√	√	√	√	
12	* Steering bearings	<ul style="list-style-type: none"> <li>• Check bearing assembly for looseness.</li> <li>• Moderately repack every 16,000 mi (25,000 km) or 24 months. #2</li> </ul>		√	√	√	√ Repack.	√	
13	Brake/Clutch lever pivot shaft	<ul style="list-style-type: none"> <li>• Apply chain lube lightly. #1</li> </ul>		√	√	√	√	√	
14	Brake pedal	<ul style="list-style-type: none"> <li>• Apply chain lube lightly. #1</li> </ul>		√	√	√	√	√	
15	* Drive chain	<ul style="list-style-type: none"> <li>• Check chain slack/alignment condition.</li> <li>• Adjust and lubricate chain thoroughly #1.</li> </ul>	<b>Every 600 mi (1,000 km) or after washing the motorcycle or riding the rain.</b>						
16	* Wheel bearings	<ul style="list-style-type: none"> <li>• Check bearings for smooth operation.</li> </ul>		√	√	√	√	√	
17	* Sidestand pivot	<ul style="list-style-type: none"> <li>• Check operation and lubricate.</li> <li>• Apply chain lube lightly. #1</li> </ul>		√	√	√	√	√	
18	* Sidestand switch	<ul style="list-style-type: none"> <li>• Check and clean or replace if necessary.</li> </ul>	√	√	√	√	√	√	

# PERIODIC MAINTENANCE AND MINOR REPAIR

No.	ITEM	ROUTINE	INITIAL	ODOMETER READINGS					
			600 mi (1,000 km) or 1 month	4,000 mi (7,000 km) or 6 months	8,000 mi (13,000 km) or 12 months	12,000 mi (19,000 km) or 18 months	16,000 mi (25,000 km) or 24 months	20,000 mi (31,000 km) or 30 months	
19	*	<b>Chassis fasteners</b>	<ul style="list-style-type: none"> <li>• Check all chassis fitting and fasteners.</li> <li>• Correct if necessary.</li> </ul>		√	√	√	√	√

\* Since these items require special tools, data and technical skills, have a Yamaha dealer perform the service.

#1 : Yamaha chain and cable lube or SAE10W30 motor oil

#2 : Lithium-soap-based grease (all-purpose grease)

#3 : Ethylene glycol anti-freeze coolant

EAU01695

## NOTE:

For odometer readings or time periods higher than 20,000 mi (31,000 km) or 30 months, follow the maintenance requirements listed in the maintenance chart under the 4,000 mi (7,000 km) or 6 month interval.

EAU03234

## NOTE:

- The air filter needs more frequent service if you are riding in unusually wet or dusty areas.
- Hydraulic brake service
  - Regularly check and, if necessary, correct the brake fluid level.
  - Every two years replace the internal components of the brake master cylinder and caliper, and change the brake fluid.
  - Replace the brake hoses every four years and if cracked or damaged.
- Engine oil type
  - Yamalube 4 (20W-40) or engine oil SAE 20W-40 (API SE) for temperatures of 40°F (5°C) or above.
  - Yamalube 4 (10W-30) or engine oil SAE 10W-30 (API SE) for temperatures of 60°F (15°C) or below.



# PERIODIC MAINTENANCE AND MINOR REPAIR

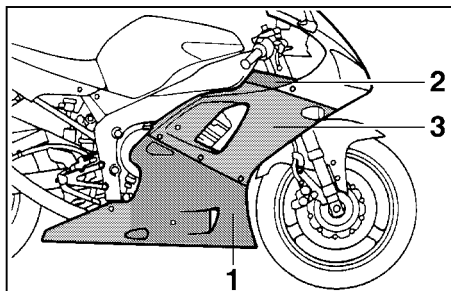

1. Cowling A
2. Panel A
3. Cowling B

## Removing and installing cowlings and panels

The cowlings and panels shown above need to be removed to perform some of the maintenance jobs described in this chapter. Refer to this section each time a cowling or panel needs to be removed and installed.

EAU01139

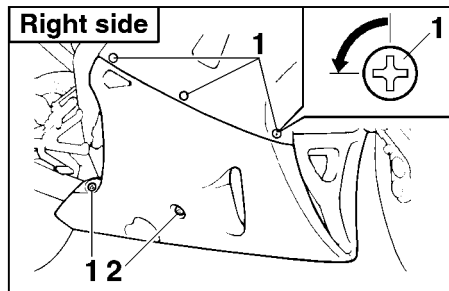

1. Quick fastener screw (× 4)
2. Screw

### Cowling A

#### To remove the cowling

Remove the screw, loosen the quick fastener screws 1/4 turn counterclockwise, and then take the cowling off.

EAU03536

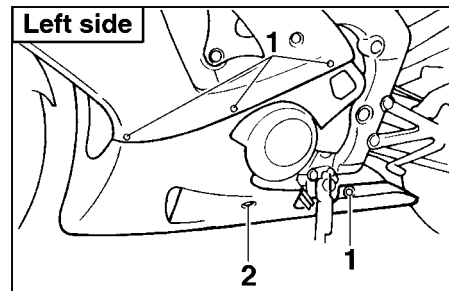

1. Quick fastener screw (× 4)
2. Screw

#### To install the cowling

Place the cowling in the original position, and then tighten the quick fastener screws and install the screw.

# PERIODIC MAINTENANCE AND MINOR REPAIR

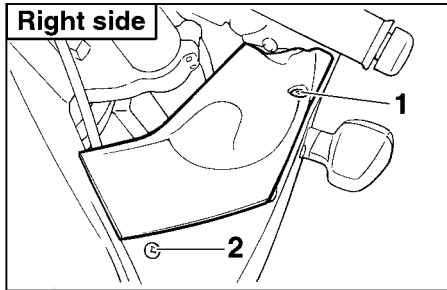

1. Screw
2. Quick fastener screw

EAU01255

## Panel A

### To remove the panel

Loosen the quick fastener screw and remove the screw, and then take the panel off.

### To install the panel

Place the panel in the original position, and then tighten the quick fastener screw and install the screw.

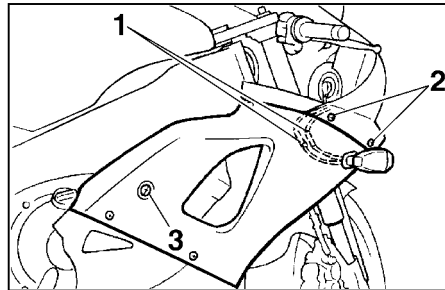

1. Lead connector (× 2)
2. Quick fastener screw (× 2)
3. Screw

EAU01259

## Cowling B

### To remove the cowling

1. Remove cowling A and panel A.
2. Disconnect the turn signal light lead connectors.
3. Remove the screw, loosen the quick fastener screws, remove the quick fastener at the front of the cowling, and then take the cowling off.

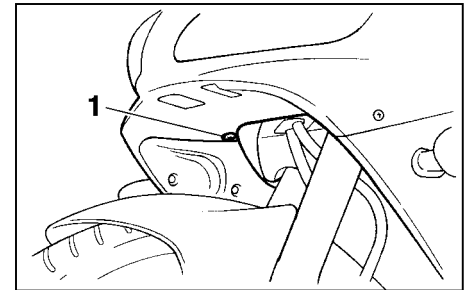

1. Quick fastener

### **NOTE:**

The quick fastener is removed by pushing the center pin in with a screwdriver, then pulling the fastener out.

# PERIODIC MAINTENANCE AND MINOR REPAIR

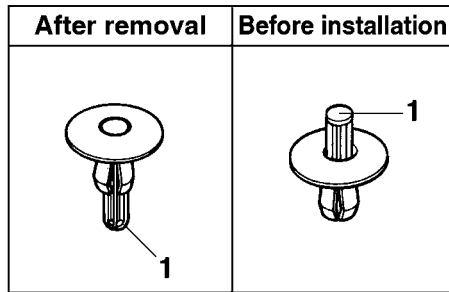

1. Quick fastener

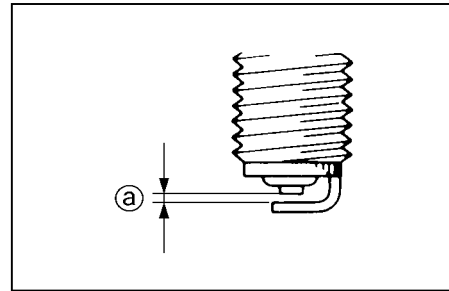

a. Spark plug gap

the engine should have the same color. If any spark plug shows a distinctly different color, the engine could be defective. Do not attempt to diagnose such problems yourself. Instead, have a Yamaha dealer check the motorcycle. If a spark plug shows signs of electrode erosion and excessive carbon or other deposits, it should be replaced.

## To install the cowling

1. Connect the turn signal light lead connectors.
2. Place the cowling in the original position.
3. Install the screw, tighten the quick fastener screws, and then install the quick fastener.

## NOTE:

To install the quick fastener, push the center pin out so that it will protrude from the fastener head, insert the fastener into the cowling, and then push the protruding pin in until it is flush with the fastener head.

4. Install the cowling and the panel.

## Checking the spark plugs

EAU01880

The spark plugs are important engine components, which should be checked periodically, preferably by a Yamaha dealer. Since heat and deposits will cause any spark plug to slowly erode, they should be removed and checked in accordance with the periodic maintenance and lubrication chart. In addition, the condition of the spark plugs can reveal the condition of the engine.

The porcelain insulator around the center electrode of each spark plug should be a medium-to-light tan (the ideal color when the motorcycle is ridden normally), and all spark plugs installed in

Specified spark plug:  
CR9E (NGK) or  
U27ESR-N (DENSO)

Before installing a spark plug, the spark plug gap should be measured with a wire thickness gauge and, if necessary, adjusted to specification.

Spark plug gap:  
0.7–0.8 mm (0.028–0.031 in)

# PERIODIC MAINTENANCE AND MINOR REPAIR

Clean the surface of the spark plug gasket and its mating surface, and then wipe off any grime from the spark plug threads.

Tightening torque:

Spark plug:

12.5 Nm (1.25 m·kg, 9.0 ft·lb)

## NOTE:

If a torque wrench is not available when installing a spark plug, a good estimate of the correct torque is 1/4–1/2 turn past finger tight. However, the spark plug should be tightened to the specified torque as soon as possible.

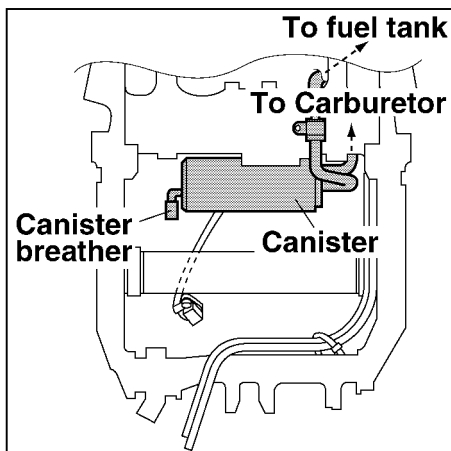

- Make sure that the canister breather is not blocked, and if necessary, clean it.

EAU00499

## Canister (for California only)

This model is equipped with a canister to prevent the discharging of fuel vapor into the atmosphere. Before operating this motorcycle, make sure to check the following:

- Check each hose connection.
- Check each hose and canister for cracks or damage. Replace if damaged.

# PERIODIC MAINTENANCE AND MINOR REPAIR

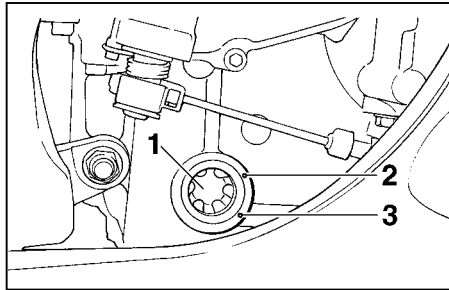

1. Engine oil level check window
2. Maximum level mark
3. Minimum level mark

EAU03612

## Engine oil and oil filter cartridge

The engine oil level should be checked before each ride. In addition, the oil must be changed and the oil filter cartridge replaced at the intervals specified in the periodic maintenance and lubrication chart.

### To check the engine oil level

1. Place the motorcycle on a level surface and hold it in an upright position.

**NOTE:** \_\_\_\_\_  
Make sure that the motorcycle is positioned straight up when checking the oil level. A slight tilt to the side can result in a false reading.

2. Start the engine, warm it up for several minutes, and then turn it off.
3. Wait a few minutes until the oil settles, and then check the oil level through the check window located at the bottom-right side of the crankcase.

**NOTE:** \_\_\_\_\_  
The engine oil should be between the minimum and maximum level marks.

4. If the engine oil is below the minimum level mark, add sufficient oil of the recommended type to raise it to the correct level.

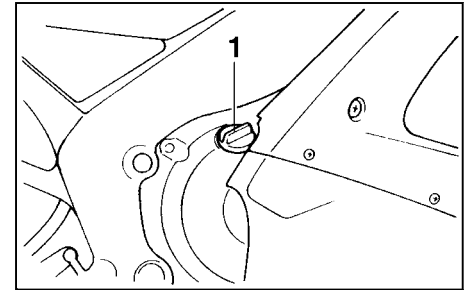

1. Engine oil filler cap

## To change the engine oil (with or without oil filter cartridge replacement)

1. Remove cowling A. (See page 6-8 for cowling removal and installation procedures.)

# PERIODIC MAINTENANCE AND MINOR REPAIR

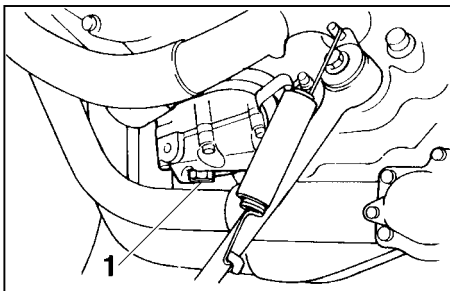

1. Engine oil drain bolt

2. Start the engine, warm it up for several minutes, and then turn it off.
3. Place an oil pan under the engine to collect the used oil.
4. Remove the engine oil filler cap and drain bolt to drain the oil from the crankcase.

**NOTE:** \_\_\_\_\_  
Skip steps 5–7 if the oil filter cartridge is not being replaced.

---

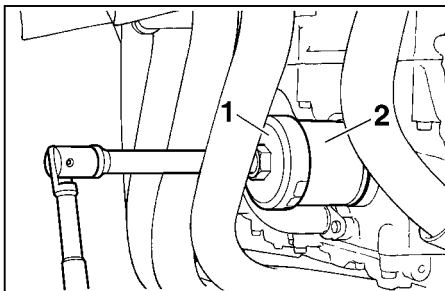

1. Oil filter wrench  
2. Oil filter cartridge

5. Remove the oil filter cartridge with an oil filter wrench.

**NOTE:** \_\_\_\_\_  
An oil filter wrench is available at a Yamaha dealer.

---

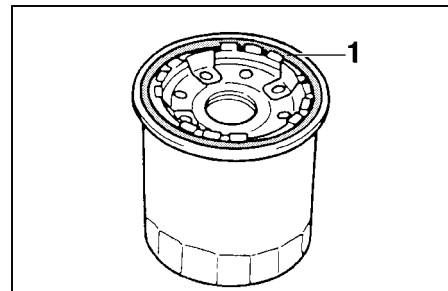

1. O-ring

6. Apply a thin coat of engine oil to the O-ring of the new oil filter cartridge.

**NOTE:** \_\_\_\_\_  
Make sure that the O-ring is properly seated.

---

# PERIODIC MAINTENANCE AND MINOR REPAIR

EC000072

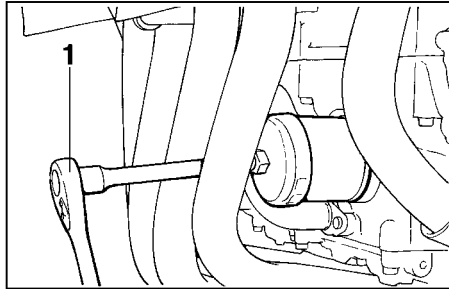

1. Torque wrench

7. Install the new oil filter cartridge, and then tighten it to the specified torque with a torque wrench.

Tightening torque:

Oil filter cartridge:

17 Nm (1.7 m·kg, 12 ft·lb)

8. Install the engine oil drain bolt, and then tighten it to the specified torque.

Tightening torque:

Engine oil drain bolt:

43 Nm (4.3 m·kg, 31 ft·lb)

9. Add the specified amount of the recommended engine oil, and then install and tighten the oil filler cap.

Recommended engine oil:

See page 8-1.

Oil quantity:

Without oil filter cartridge replacement:

2.7 L (2.38 Imp qt, 2.85 US qt)

With oil filter cartridge replacement:

2.9 L (2.55 Imp qt, 3.07 US qt)

Total amount (dry engine):

3.6 L (3.17 Imp qt, 3.81 US qt)

## CAUTION:

- In order to prevent clutch slippage (since the engine oil also lubricates the clutch), do not mix any chemical additives with the oil or use oils of a higher grade than “CD”. In addition, do not use oils labeled “ENERGY CONSERVING II” or higher.
- Make sure that no foreign material enters the crankcase.

10. Start the engine, and then let it idle for several minutes while checking it for oil leakage. If oil is leaking, immediately turn the engine off and check for the cause.

## NOTE:

After the engine is started, the engine oil level warning light should go off if the oil level is sufficient.

# PERIODIC MAINTENANCE AND MINOR REPAIR

EC000067

## CAUTION:

If the oil level warning light flickers or remains on, immediately turn the engine off and have a Yamaha dealer check the vehicle.

11. Turn the engine off, and then check the oil level and correct it if necessary.
12. Install the cowl.

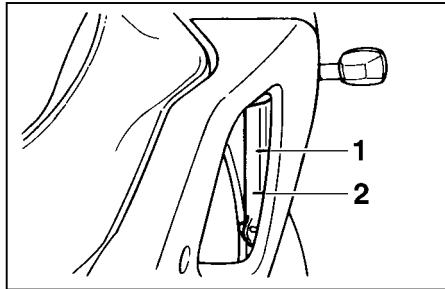

1. Maximum level mark
2. Minimum level mark

EAU03161

## Coolant

### To check the coolant level

1. Place the motorcycle on a level surface and hold it in an upright position.

### NOTE:

- The coolant level must be checked on a cold engine since the level varies with engine temperature.
- Make sure that the motorcycle is positioned straight up when checking the coolant level. A slight tilt to the side can result in a false reading.

2. Check the coolant level in the coolant reservoir.

### NOTE:

The coolant should be between the minimum and maximum level marks.

3. If the coolant is at or below the minimum level mark, open the reservoir cap, add coolant to the maximum level mark, and then close the reservoir cap.

Coolant reservoir capacity:  
0.45 L (0.4 Imp qt, 0.48 US qt)

EC000080

## CAUTION:

- If coolant is not available, use distilled water or soft tap water instead. Do not use hard water or salt water since it is harmful to the engine.
- If water has been used instead of coolant, replace it with coolant as soon as possible, otherwise the engine may not be



# PERIODIC MAINTENANCE AND MINOR REPAIR

sufficiently cooled and the cooling system will not be protected against frost and corrosion.

- If water has been added to the coolant, have a Yamaha dealer check the antifreeze content of the coolant as soon as possible, otherwise the effectiveness of the coolant will be reduced.

## NOTE:

- The radiator fan is automatically switched on or off according to the coolant temperature in the radiator.
- When the engine is idling with the starter (choke) turned on, the radiator fan will automatically be switched on and off regardless of the coolant temperature, but this does not indicate a malfunction.
- If the engine overheats, see page 6-49 for further instructions.

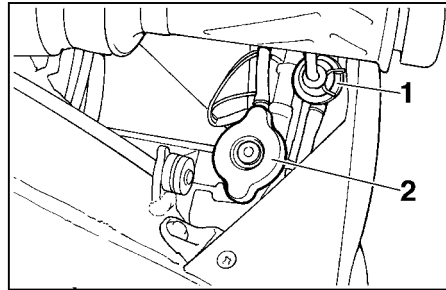

1. Coolant reservoir cap
2. Radiator cap

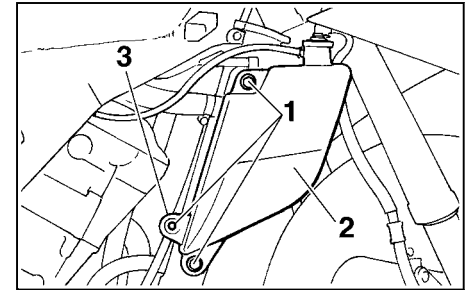

1. Bolt (× 3)
2. Coolant reservoir
3. Clutch cable holder bolt

## To change the coolant

1. Place the motorcycle on a level surface and let the engine cool if necessary.
2. Remove cowlings A and B, and panel A. (See pages 6-8 and 6-9 for cowling and panel removal and installation procedures.)
3. Place a container under the engine to collect the used coolant.

4. Remove the radiator cap and coolant reservoir cap.

## **! WARNING**

**Never attempt to remove the radiator cap when the engine is hot.**

5. Remove the coolant reservoir bolts and the clutch cable holder bolt, and then turn the coolant reservoir upside-down to empty it.
6. Install the coolant reservoir and the clutch cable holder by installing the bolts.

# PERIODIC MAINTENANCE AND MINOR REPAIR

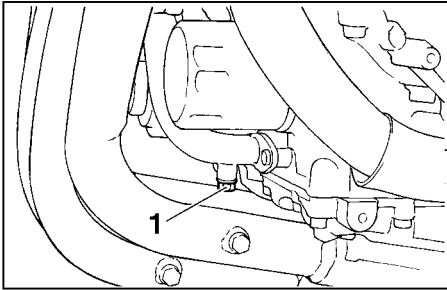

1. Coolant drain bolt

7. Remove the coolant drain bolt to drain the cooling system.

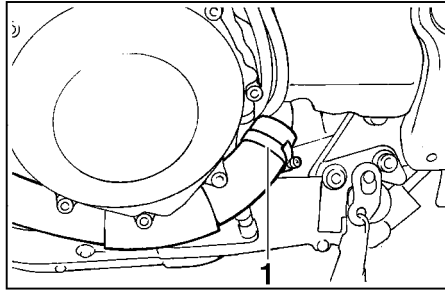

1. Screw clamp

8. Loosen the radiator hose clamp screw located at the left side of the engine, and then pull off the hose to drain the radiator.
9. After the coolant is completely drained, thoroughly flush the cooling system with clean tap water.
10. Install the coolant drain bolt, and then tighten it to the specified torque.

**NOTE:** \_\_\_\_\_  
Check the washer for damage and replace it if necessary.  
\_\_\_\_\_

Tightening torque:

Coolant drain bolt:

7 Nm (0.7 m·kg, 5.1 ft·lb)

11. Connect the radiator hose, and then tighten the clamp screw.
12. Pour the specified amount of recommended coolant into the radiator and reservoir.

Antifreeze/water mixture ratio:

1:1

Recommended antifreeze:

High-quality ethylene glycol antifreeze containing corrosion inhibitors for aluminum engines

Coolant quantity:

Total amount:

2.55 L (2.24 Imp qt, 2.7 US qt)

Coolant reservoir capacity:

0.45 L (0.4 Imp qt, 0.48 US qt)

# PERIODIC MAINTENANCE AND MINOR REPAIR

EC000080

## CAUTION:

- If coolant is not available, use distilled water or soft tap water instead. Do not use hard water or salt water since it is harmful to the engine.
- If water has been used instead of coolant, replace it with coolant as soon as possible, otherwise the engine may not be sufficiently cooled and the cooling system will not be protected against frost and corrosion.
- If water has been added to the coolant, have a Yamaha dealer check the antifreeze content of the coolant as soon as possible, otherwise the effectiveness of the coolant will be reduced.

13. Install the radiator cap, start the engine, let it idle for several minutes, and then turn it off.
14. Remove the radiator cap to check the coolant level in the radiator. If necessary, add sufficient coolant until it reaches the top of the radiator, and then install the radiator cap.
15. Check the coolant level in the reservoir. If necessary, remove the coolant reservoir cap, add coolant to the maximum level mark, and then install the cap.
16. Start the engine, and then check the vehicle for coolant leakage. If coolant is leaking, have a Yamaha dealer check the cooling system.
17. Install the cowlings and the panel.

# PERIODIC MAINTENANCE AND MINOR REPAIR

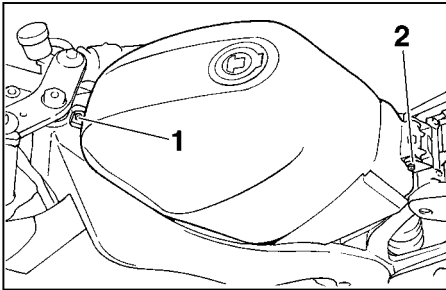

1. Bolt (front)
2. Bolt (rear)

EAU03162

## Cleaning the air filter element

The air filter element should be cleaned at the intervals specified in the periodic maintenance and lubrication chart. Clean the air filter element more frequently if you are riding in unusually wet or dusty areas.

1. Remove the rider seat. (See page 3-12 for rider seat removal and installation procedures.)
2. Remove the bolt at the front of the fuel tank and loosen the bolt at the rear.

3. Lift the front of the fuel tank, and then tilt it back and away from the air filter case. (Do not disconnect the fuel hoses!)

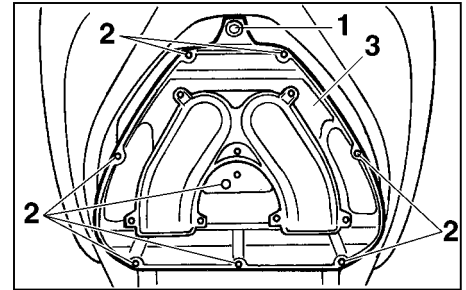

1. Bolt
2. Screw (× 8)
3. Air filter case cover

EW000071

### **⚠ WARNING**

- Make sure that the fuel tank is well supported.
- Do not tilt or pull the fuel tank too much, otherwise the fuel hoses may come loose, which could cause fuel leakage.

4. Remove the air filter case cover by removing the screws and bolt.

# PERIODIC MAINTENANCE AND MINOR REPAIR

EC000082

EW000072

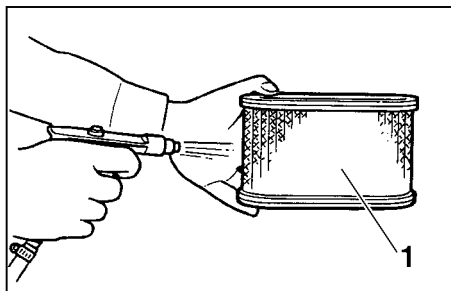

1. Air filter element

## CAUTION:

- Make sure that the air filter element is properly seated in the air filter case.
- The engine should never be operated without the air filter element installed, otherwise the piston(s) and/or cylinder(s) may become excessively worn.

## ! WARNING

- Before installing the fuel tank, make sure that the fuel hoses are not damaged. If any fuel hose is damaged, do not start the engine but have a Yamaha dealer replace the hose, otherwise fuel may leak.
- Make sure that the fuel hoses are properly connected and routed, and not pinched.

5. Pull the air filter element out.
6. Lightly tap the air filter element to remove most of the dust and dirt, and then blow the remaining dirt out with compressed air as shown. If the air filter element is damaged, replace it.
7. Insert the air filter element into the air filter case.

8. Install the air filter case cover by installing the screws and bolt.
9. Place the fuel tank in the original position, and then install the bolt at the front and tighten the bolt at the rear.

# PERIODIC MAINTENANCE AND MINOR REPAIR

EAU00628

## Adjusting the carburetors

The carburetors are important parts of the engine and emission control system, which require very sophisticated adjustment. Therefore, all carburetor adjustments should be left to a Yamaha dealer, who has the necessary professional knowledge and experience.

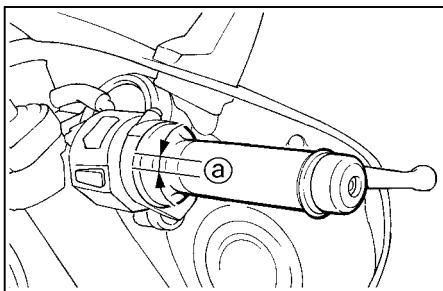

a. Throttle cable free play

EAU00635

## Adjusting the throttle cable free play

The throttle cable free play should measure 3–5 mm (0.1–0.2 in) at the throttle grip. Periodically check the throttle cable free play and, if necessary, have a Yamaha dealer adjust it.

EAU00637

## Adjusting the valve clearance

The valve clearance changes with use, resulting in improper air-fuel mixture and/or engine noise. To prevent this from occurring, the valve clearance must be adjusted by a Yamaha dealer at the intervals specified in the periodic maintenance and lubrication chart.

# PERIODIC MAINTENANCE AND MINOR REPAIR

EAU03581

## Tires

To maximize the performance, durability, and safe operation of your motorcycle, note the following points regarding the specified tires.

### Tire air pressure

The tire air pressure should be checked and, if necessary, adjusted before each ride.

EW000082

#### **WARNING**

- The tire air pressure must be checked and adjusted on cold tires (i.e., when the temperature of the tires equals the ambient temperature).
- The tire air pressure must be adjusted in accordance with the riding speed and with the total weight of rider, passenger, cargo, and accessories approved for this model.

Tire air pressure (measured on cold tires)		
Load*	Front	Rear
Up to 90 kg (198 lb)	250 kPa 2.50 kgf/cm <sup>2</sup> 36 psi	250 kPa 2.50 kgf/cm <sup>2</sup> 36 psi
90 kg (198 lb)– maximum	250 kPa 2.50 kgf/cm <sup>2</sup> 36 psi	290 kPa 2.90 kgf/cm <sup>2</sup> 42 psi
High-speed riding	250 kPa 2.50 kgf/cm <sup>2</sup> 36 psi	250 kPa 2.50 kgf/cm <sup>2</sup> 36 psi
Maximum load*	201 kg (443 lb): YZF-R1 200 kg (441 lb): YZF-R1C	

\* Total weight of rider, passenger, cargo and accessories

EW000083

#### **WARNING**

Proper loading of your motorcycle is important for several characteristics of your motorcycle, such as handling, braking, performance and safety. Do not carry loosely packed items that can shift. Securely pack your heaviest items close to the center of the motorcycle, and distribute the weight evenly from side to side. Properly adjust the suspension for your load, and check the condition and pressure of your tires. NEVER OVERLOAD YOUR MOTORCYCLE. Make sure that the total weight of the cargo, rider, passenger, and accessories (cowling, saddlebags, etc. if approved for this model) does not exceed the maximum load of the motorcycle. Operation of an overloaded motorcycle could cause tire damage, an accident, or even injury.

# PERIODIC MAINTENANCE AND MINOR REPAIR

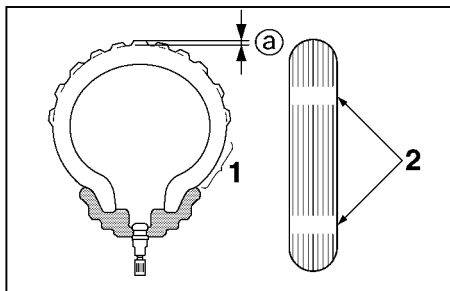

1. Sidewall
2. Wear indicator
- a. Tire tread depth

## Tire inspection

Always check the tires before operating the motorcycle. If a tire tread shows crosswise lines (minimum tread depth), if the tire has a nail or glass fragments in it, or if the side wall is cracked, contact a Yamaha dealer immediately and have the tire replaced.

Minimum tire tread depth (front and rear)	1.0 mm (0.04 in)
--	------------------

EW000094

## ⚠ WARNING

- It is dangerous to ride with a worn-out tire. When a tire tread begins to show crosswise lines, have a Yamaha dealer replace the tire immediately.
- The replacement of all wheel- and brake-related parts, including the tires, should be left to a Yamaha dealer, who has the necessary professional knowledge and experience.

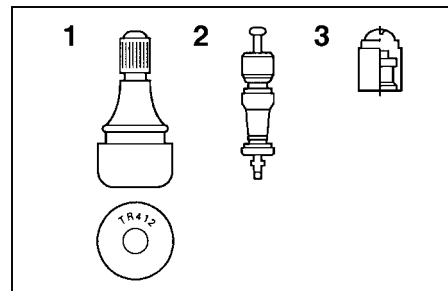

1. Tire air valve
2. Valve core
3. Valve cap with seal

## Tire information

This motorcycle is equipped with cast wheels and tubeless tires with valves.



# PERIODIC MAINTENANCE AND MINOR REPAIR

EW000080

## **WARNING**

- The front and rear tires should be of the same make and design, otherwise the handling characteristics of the motorcycle cannot be guaranteed.
- After extensive tests, only the tires listed below have been approved for this model by Yamaha Motor Co., Ltd.
- Always make sure that the valve caps are securely installed to prevent air pressure leakage.
- Use only the tire valves and valve cores listed below to avoid tire deflation during a high-speed ride.

### FRONT

Manufacturer	Size	Type
Metzeler	120/70 ZR17 (58W)	MEZ3Y Front
Dunlop	120/70 ZR17 (58W)	D207FQ

### REAR

Manufacturer	Size	Type
Metzeler	190/50 ZR17 (73W)	MEZ3Y
Dunlop	190/50 ZR17 (73W)	D207N

FRONT & REAR	
Tire air valve	TR412
Valve core	#9000A (original)

EAU00684

## **WARNING**

This motorcycle is fitted with super-high-speed tires. Note the following points in order to make the most efficient use of these tires.

- Use only the specified replacement tires. Other tires may run the danger of bursting at super high speeds.
- Brand-new tires can have a relatively poor grip on certain road surfaces until they have been “broken in”. Therefore, it is advisable before doing any high-speed riding to ride conservatively for approximately 100 km (60 mi) after installing a new tire.
- The tires must be warmed up before a high-speed run.
- Always adjust the tire air pressure according to the operating conditions.

# PERIODIC MAINTENANCE AND MINOR REPAIR

## Wheels

EAU00687

To maximize the performance, durability, and safe operation of your motorcycle, note the following points regarding the specified wheels.

- The wheel rims should be checked for cracks, bends or warpage before each ride. If any damage is found, have a Yamaha dealer replace the wheel. Do not attempt even the smallest repair to the wheel. A deformed or cracked wheel must be replaced.
- The wheel should be balanced whenever either the tire or wheel has been changed or replaced. An unbalanced wheel can result in poor performance, adverse handling characteristics, and a shortened tire life.
- Ride at moderate speeds after changing a tire since the tire surface must first be “broken in” for it to develop its optimal characteristics.

## Accessories and replacement parts

EAU00691

EW000098

### **WARNING**

**This motorcycle is not designed to pull a trailer or to be attached to a sidecar. The accessories or replacement parts you choose for your motorcycle should be designed specifically for this model, and they must be securely mounted to maintain the inherent stability of the original design. Genuine Yamaha Parts and Accessories are designed and tested to be compatible with your motorcycle. Please consider Genuine Yamaha Parts and Accessories before making a purchase. Use of non-Yamaha-approved accessories or replacement parts may cause loss of handling stability and riding safety. Since Yamaha cannot control the quality of accessories or parts manufactured by other companies, Yamaha cannot be held liable for any consequences caused**

**by the use of items which have not been approved by Yamaha.**

# PERIODIC MAINTENANCE AND MINOR REPAIR

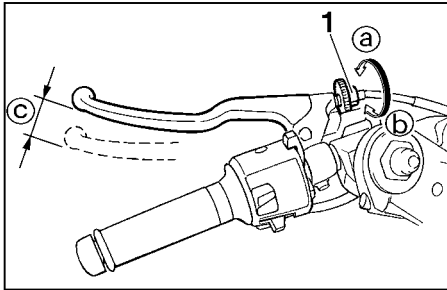

- 1. Adjusting bolt
- c. Clutch lever free play

EAU01356

## Adjusting the clutch lever free play

The clutch lever free play should measure 10–15 mm (0.4–0.6 in) as shown. Periodically check the clutch lever free play and, if necessary, adjust it as follows.

To increase the clutch lever free play, turn the adjusting bolt at the clutch lever in direction (a). To decrease the clutch lever free play, turn the adjusting bolt in direction (b).

**NOTE:** \_\_\_\_\_  
If the specified clutch lever free play cannot be obtained as described above, proceed as follows.

1. Fully turn the adjusting bolt at the clutch lever in direction (a) to loosen the clutch cable.

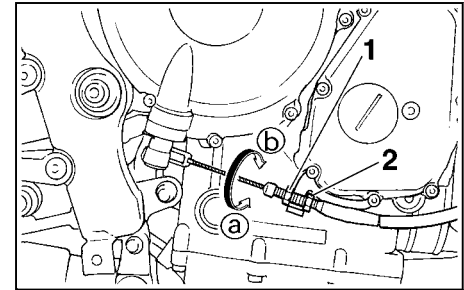

- 1. Locknut
- 2. Clutch lever free play adjusting nut

2. Remove cowling A. (See page 6-8 for cowling removal and installation procedures.)
3. Loosen the locknut at the crankcase.
4. To increase the clutch lever free play, turn the adjusting nut in direction (a). To decrease the clutch lever free play, turn the adjusting nut in direction (b).
5. Tighten the locknut.
6. Install the cowling.

# PERIODIC MAINTENANCE AND MINOR REPAIR

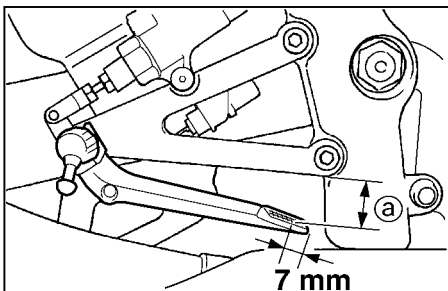

a. Distance between brake pedal and footrest bracket

EAU01357

## Adjusting the brake pedal position

6 The top of the brake pedal should be positioned approximately 35–40 mm (1.4–1.6 in) below the bottom of the footrest bracket as shown. Periodically check the brake pedal position and, if necessary, have a Yamaha dealer adjust it.

EW000109

### **⚠ WARNING**

A soft or spongy feeling in the brake pedal can indicate the presence of air in the hydraulic system. If there is air in the hydraulic system, have a Yamaha dealer bleed the system before operating the motorcycle. Air in the hydraulic system will diminish the braking performance, which may result in loss of control and an accident.

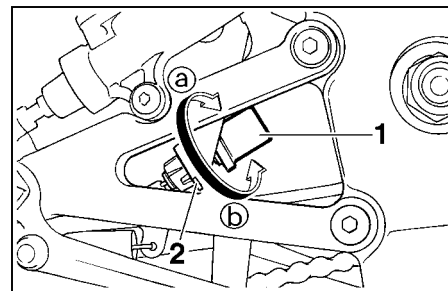

1. Rear brake light switch
2. Rear brake light adjusting nut

EAU00713

## Adjusting the rear brake light switch

The rear brake light switch, which is activated by the brake pedal, is properly adjusted when the brake light comes on just before braking takes effect. If necessary, adjust the brake light switch as follows.

Turn the adjusting nut while holding the rear brake light switch in place. To make the brake light come on earlier, turn the adjusting nut in direction Ⓐ. To make the brake light come on later, turn the adjusting nut in direction Ⓑ.

# PERIODIC MAINTENANCE AND MINOR REPAIR

## Checking the front and rear brake pads

The front and rear brake pads must be checked for wear at the intervals specified in the periodic maintenance and lubrication chart.

EAU00721

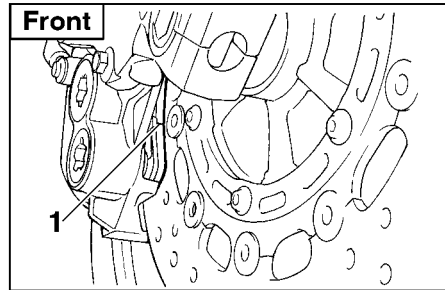

1. Wear indicator groove

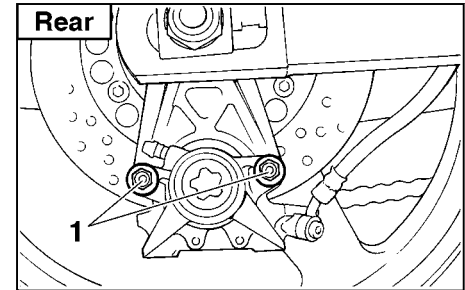

1. Caliper bolt (× 2)

EAU00725

### Front brake pads

Each front brake pad is provided with a wear indicator groove, which allows you to check the brake pad wear without having to disassemble the brake. To check the brake pad wear, check the wear indicator groove. If a brake pad has worn to the point that the wear indicator groove has almost disappeared, have a Yamaha dealer replace the brake pads as a set.

EAU01248

### Rear brake pads

1. Remove the rear brake caliper by removing the bolts.

# PERIODIC MAINTENANCE AND MINOR REPAIR



a. Lining thickness

2. Check each rear brake pad for damage and measure the lining thickness. If a brake pad is damaged or if the lining thickness is less than 0.5 mm (0.02 in), have a Yamaha dealer replace the brake pads as a set.
3. Install the rear brake caliper by installing the bolts, then tightening them to the specified torque.

Tightening torque:  
Brake caliper bolt:  
40 Nm (4.0 m·kg, 29 ft·lb)

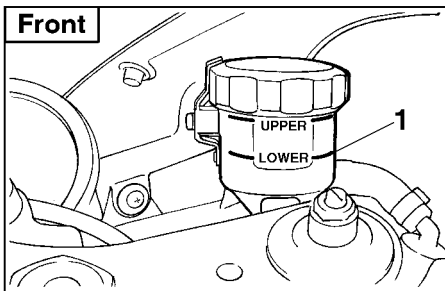

1. Minimum level mark

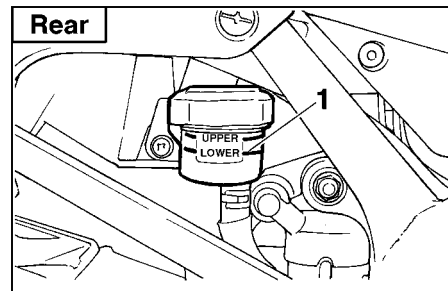

1. Minimum level mark

## Checking the brake fluid level

EAU03607

Insufficient brake fluid may allow air to enter the brake system, possibly causing it to become ineffective.

Before riding, check that the brake fluid is above the minimum level mark and replenish if necessary. A low brake fluid level may indicate worn brake pads and/or brake system leakage. If the brake level is low, be sure to check the brake pads for wear and the brake system for leakage.

Observe these precautions:

- When checking the fluid level, make sure that the top of the master cylinder or brake fluid reservoir is level.
- Use only the recommended quality brake fluid, otherwise the rubber seals may deteriorate, causing leakage and poor braking performance.

Recommended brake fluid: DOT 4

# PERIODIC MAINTENANCE AND MINOR REPAIR

- Refill with the same type of brake fluid. Mixing fluids may result in a harmful chemical reaction and lead to poor braking performance.
- Be careful that water does not enter the master cylinder or brake fluid reservoir when refilling. Water will significantly lower the boiling point of the fluid and may result in vapor lock.
- Brake fluid may deteriorate painted surfaces or plastic parts. Always clean up spilled fluid immediately.
- As the brake pads wear, it is normal for the brake fluid level to gradually go down. However, if the brake fluid level goes down suddenly, have a Yamaha dealer check the cause.

EAU03238

## Changing the brake fluid

Have a Yamaha dealer change the brake fluid at the intervals specified in the periodic maintenance and lubrication chart. In addition, have the oil seals of the brake master cylinder and caliper as well as the brake hose replaced at the intervals listed below or whenever they are damaged or leaking.

- Oil seals: Replace every two years.
- Brake hose: Replace every four years.

# PERIODIC MAINTENANCE AND MINOR REPAIR

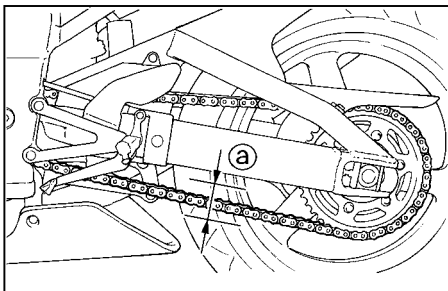

a. Drive chain slack

EAU00744

## Drive chain slack

The drive chain slack should be checked before each ride and adjusted if necessary.

### To check the drive chain slack

1. Place the motorcycle on a level surface and hold it in an upright position.

### NOTE:

When checking and adjusting the drive chain slack, the motorcycle should be positioned straight up and there should be no weight on it.

2. Shift the transmission into the neutral position.
3. Move the rear wheel by pushing the motorcycle to locate the tightest portion of the drive chain, and then measure the drive chain slack as shown.

Drive chain slack:  
40–50 mm (1.57–1.97 in)

4. If the drive chain slack is incorrect, adjust it as follows.

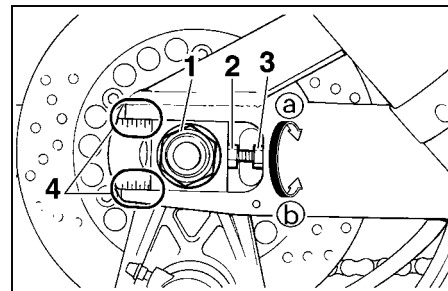

1. Axle nut
2. Drive chain slack adjusting bolt
3. Locknut
4. Alignment marks

EAU03608

### To adjust the drive chain slack

1. Loosen the axle nut and the locknut on each side of the swingarm.
2. To tighten the drive chain, turn the adjusting bolt on each side of the swingarm in direction Ⓐ. To loosen the drive chain, turn the adjusting bolt on each side of the swingarm in direction Ⓑ, and then push the rear wheel forward.



# PERIODIC MAINTENANCE AND MINOR REPAIR

**NOTE:** \_\_\_\_\_  
Using the alignment marks on each side of the swingarm, make sure that both chain pullers are in the same position for proper wheel alignment.

EC000096

**CAUTION:** \_\_\_\_\_  
**Improper drive chain slack will overload the engine as well as other vital parts of the motorcycle and can lead to chain slippage or breakage. To prevent this from occurring, keep the drive chain slack within the specified limits.**

3. Tighten the locknuts, and then tighten the axle nut to the specified torque.

Tightening torque:

Axle nut:

150 Nm (15.0 m·kg, 110 ft·lb)

## Lubricating the drive chain

EAU03006

The drive chain must be cleaned and lubricated at the intervals specified in the periodic maintenance and lubrication chart, otherwise it will quickly wear out, especially when riding in dusty or wet areas. Service the drive chain as follows.

EC000097

**CAUTION:** \_\_\_\_\_  
**The drive chain must be lubricated after washing the motorcycle or riding in the rain.**

1. Clean the drive chain with kerosene and a small soft brush.

ECA00053

**CAUTION:** \_\_\_\_\_  
**To prevent damaging the O-rings, do not clean the drive chain with steam cleaners, high-pressure washers or inappropriate solvents.**

2. Wipe the drive chain dry.
3. Thoroughly lubricate the drive chain with a special O-ring chain lubricant.

ECA00052

**CAUTION:** \_\_\_\_\_  
**Do not use engine oil or any other lubricants for the drive chain, as they may contain substances that could damage the O-rings.**

# PERIODIC MAINTENANCE AND MINOR REPAIR

## Checking and lubricating the cables

EAU03297

The operation of all control cables and the condition of the cables should be checked before each ride, and the cables and cable ends should be lubricated if necessary. If a cable is damaged or does not move smoothly, have a Yamaha dealer check or replace it.

Recommended lubricant:

Yamaha Chain and Cable Lube  
or engine oil SAE 10W-30  
(API SE)

EW000111

### WARNING

**Damage to the outer housing of cables may result in internal rusting and cause interference with cable movement. Replace damaged cables as soon as possible to prevent unsafe conditions.**

## Checking and lubricating the throttle grip and cable

EAU03364

The operation of the throttle grip and the condition of the throttle cable should be checked before each ride, and the cable should be lubricated or replaced if necessary.

### NOTE:

Since the throttle grip must be removed to access the throttle cable end, the throttle grip and the cable should always be lubricated at the same time.

1. Remove the throttle grip by removing the screws.
2. Disconnect the throttle cable, hold it up, and then apply several drops of oil to the cable end, allowing it to trickle into the sheath.
3. Connect the throttle cable, and then grease the inside of the throttle grip housing.

4. Grease the metal-to-metal contact surface of the throttle grip, and then install the grip by installing the screws.

Recommended lubricant:

Throttle cable:

Yamaha Chain and Cable  
Lube or engine oil  
SAE 10W-30

Throttle grip housing and grip:

Lithium-soap-based grease  
(all-purpose grease)

# PERIODIC MAINTENANCE AND MINOR REPAIR

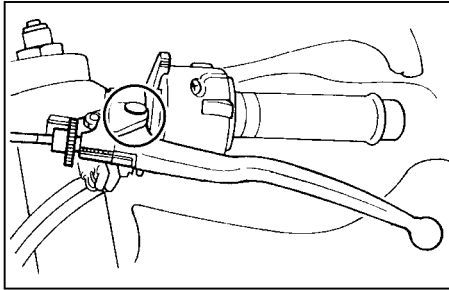

EAU03164

## Checking and lubricating the brake and clutch levers

The operation of the brake and clutch levers should be checked before each ride, and the lever pivots should be lubricated if necessary.

Recommended lubricant:  
Lithium-soap-based grease  
(all-purpose grease)

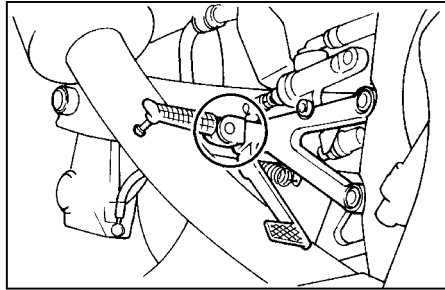

EAU03163

## Lubricating the brake pedal

The operation of the brake pedal should be checked before each ride, and the pedal pivot should be lubricated if necessary.

Recommended lubricant:  
Lithium-soap-based grease  
(all-purpose grease)

# PERIODIC MAINTENANCE AND MINOR REPAIR

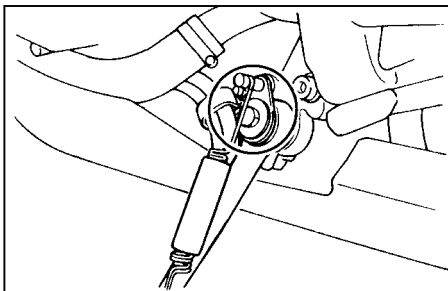

EAU03165

## Checking and lubricating the sidestand

The operation of the sidestand should be checked before each ride, and the sidestand pivot and metal-to-metal contact surfaces should be lubricated if necessary.

EW000113

### **⚠ WARNING**

**If the sidestand does not move up and down smoothly, have a Yamaha dealer check or repair it.**

Recommended lubricant:  
Lithium-soap-based grease  
(all-purpose grease)

## Lubricating the rear suspension

The pivoting points of the rear suspension must be lubricated at the intervals specified in the periodic maintenance and lubrication chart.

Recommended lubricant:  
Lithium-soap-based grease  
(all-purpose grease)

EAU03166

# PERIODIC MAINTENANCE AND MINOR REPAIR

## Checking the front fork

EAU02939

The condition and operation of the front fork must be checked as follows at the intervals specified in the periodic maintenance and lubrication chart.

### To check the condition



**Securely support the motorcycle so that there is no danger of it falling over.**

Check the inner tubes for scratches, damage and excessive oil leakage.

EW000115

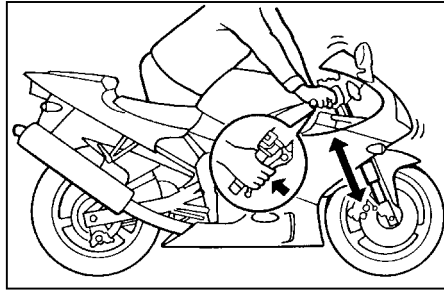

### To check the operation

1. Place the motorcycle on a level surface and hold it in an upright position.
2. While applying the front brake, push down hard on the handlebars several times to check if the front fork compresses and rebounds smoothly.

EC000098

### CAUTION:

**If any damage is found or the front fork does not operate smoothly, have a Yamaha dealer check or repair it.**

# PERIODIC MAINTENANCE AND MINOR REPAIR

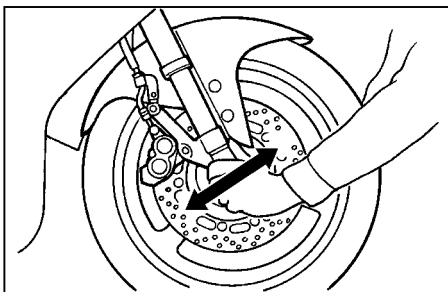

EAU00794

## Checking the steering

Worn or loose steering bearings may cause danger. Therefore, the operation of the steering must be checked as follows at the intervals specified in the periodic maintenance and lubrication chart.

1. Place a stand under the engine to raise the front wheel off the ground.

EW000115

### **⚠ WARNING**

**Securely support the motorcycle so that there is no danger of it falling over.**

2. Hold the lower ends of the front fork legs and try to move them forward and backward. If any free play can be felt, have a Yamaha dealer check or repair the steering.

EAU01144

## Checking the wheel bearings

The front and rear wheel bearings must be checked at the intervals specified in the periodic maintenance and lubrication chart. If there is play in the wheel hub or if the wheel does not turn smoothly, have a Yamaha dealer check the wheel bearings.

# PERIODIC MAINTENANCE AND MINOR REPAIR

EAU01291

EW000116

## Battery

This motorcycle is equipped with a sealed-type (MF) battery, which does not require any maintenance. There is no need to check the electrolyte or to add distilled water.

### To charge the battery

Have a Yamaha dealer charge the battery as soon as possible if it seems to have discharged. Keep in mind that the battery tends to discharge more quickly if the motorcycle is equipped with optional electrical accessories.

### WARNING

- **Electrolyte is poisonous and dangerous since it contains sulfuric acid, which causes severe burns. Avoid any contact with skin, eyes or clothing and always shield your eyes when working near batteries. In case of contact, administer the following FIRST AID.**
  - **EXTERNAL: Flush with plenty of water.**
  - **INTERNAL: Drink large quantities of water or milk and immediately call a physician.**
  - **EYES: Flush with water for 15 minutes and seek prompt medical attention.**
- **Batteries produce explosive hydrogen gas. Therefore, keep sparks, flames, cigarettes, etc., away from the battery and provide sufficient ventilation when charging it in an enclosed space.**

- **KEEP THIS AND ALL BATTERIES OUT OF THE REACH OF CHILDREN.**

### To store the battery

1. If the motorcycle will not be used for more than one month, remove the battery, fully charge it, and then place it in a cool, dry place.
2. If the battery will be stored for more than two months, check it at least once a month and fully charge it if necessary.
3. Fully charge the battery before installation.
4. After installation, make sure that the battery leads are properly connected to the battery terminals.

# PERIODIC MAINTENANCE AND MINOR REPAIR

EC000102

## CAUTION:

- Always keep the battery charged. Storing a discharged battery can cause permanent battery damage.
- To charge a sealed-type (MF) battery, a special (constant-voltage) battery charger is required. Using a conventional battery charger will damage the battery. If you do not have access to a sealed-type (MF) battery charger, have a Yamaha dealer charge your battery.

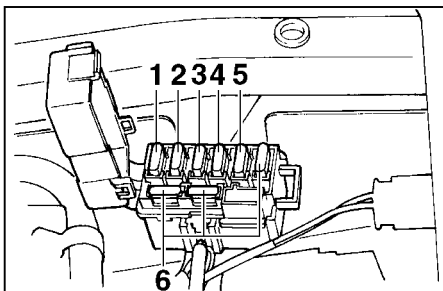

1. Headlight fuse
2. Radiator fan fuse
3. Ignition fuse
4. Signaling system fuse
5. Odometer fuse
6. Spare fuse (× 3)

EAU03610

## Replacing the fuses

The main fuse and the fuse box, which contains the fuses for the individual circuits, are located under the rider seat. (See page 3-12 for rider seat removal and installation procedures.)

If a fuse is blown, replace it as follows.

1. Turn the key to "OFF" and turn off the electrical circuit in question.
2. Remove the blown fuse, and then install a new fuse of the specified amperage.

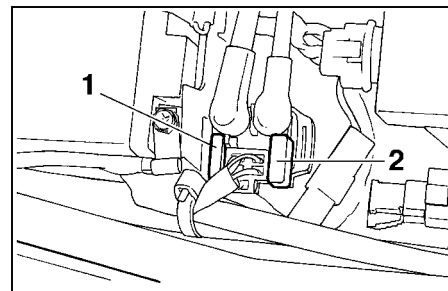

1. Main fuse
2. Spare main fuse

## Specified fuses:

Main fuse:	30 A
Headlight fuse:	20 A
Signaling system fuse:	20 A
Radiator fan fuse:	10 A
Ignition fuse:	15 A
Odometer fuse:	10 A



# PERIODIC MAINTENANCE AND MINOR REPAIR

EC000103

## CAUTION:

Do not use a fuse of a higher amperage rating than recommended to avoid causing extensive damage to the electrical system and possibly a fire.

3. Turn the key to "ON" and turn on the electrical circuit in question to check if the device operates.
4. If the fuse immediately blows again, have a Yamaha dealer check the electrical system.

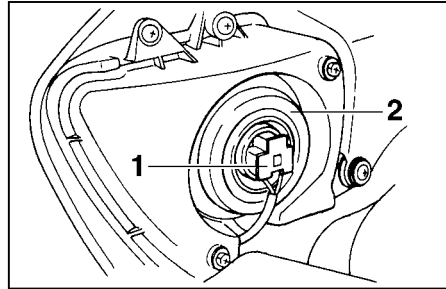

1. Headlight coupler
2. Headlight bulb cover

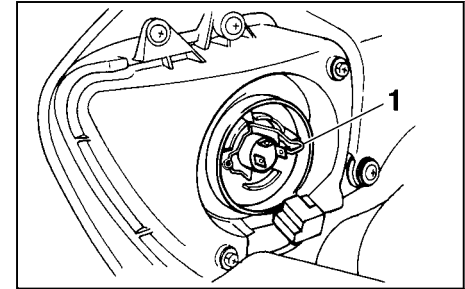

1. Headlight bulb holder
2. Unhook the headlight bulb holder, and then remove the defective bulb.

## Replacing the headlight bulb

This motorcycle is equipped with a quartz bulb headlight. If the headlight bulb burns out, replace it as follows.

1. Disconnect the headlight coupler, and then remove the headlight bulb cover.

EAU00826

# PERIODIC MAINTENANCE AND MINOR REPAIR

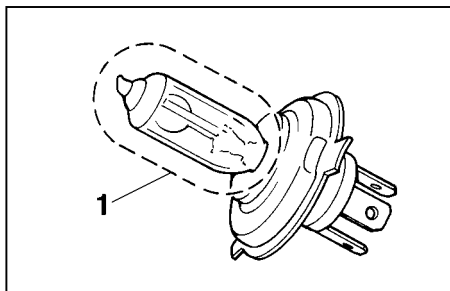

1. Do not touch this area.

EW000119

## **WARNING**

Headlight bulbs get very hot. Therefore, keep flammable products away from a lit headlight bulb, and do not touch the bulb until it has cooled down.

3. Place a new bulb into position, and then secure it with the bulb holder.

EC000104

## **CAUTION:**

Take care not to damage the following parts:

- **Headlight bulb**  
Do not touch the glass part of the headlight bulb to keep it free from oil, otherwise the transparency of the glass, the luminosity of the bulb, and the bulb life will be adversely affected. Thoroughly clean off any dirt and fingerprints on the headlight bulb using a cloth moistened with alcohol or thinner.
- **Headlight lens**
  - Do not affix any type of tinted film or stickers to the headlight lens.
  - Do not use a headlight bulb of a wattage higher than specified.

4. Install the bulb cover, and then connect the coupler.
5. Have a Yamaha dealer adjust the headlight beam if necessary.

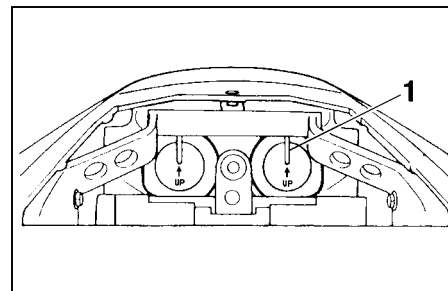

1. Tail/brake light bulb cover

EAU01358

## Replacing the tail/brake light bulb

1. Remove the passenger seat. (See page 3-13 for passenger seat removal and installation procedures.)
2. Remove the tail/brake light bulb cover.

# PERIODIC MAINTENANCE AND MINOR REPAIR

ECA00065

## CAUTION:

Do not overtighten the screw, otherwise the lens may break.

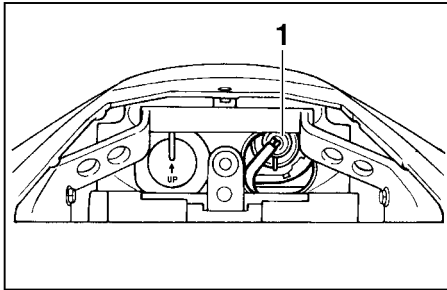

1. Socket

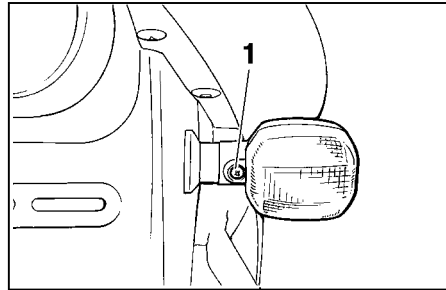

1. Screw

EAU03497

## Replacing a turn signal light bulb

3. Remove the socket (together with the bulb) by turning it counter-clockwise.
  4. Remove the defective bulb by pushing it in and turning it counter-clockwise.
  5. Insert a new bulb into the socket, push it in, and then turn it clockwise until it stops.
  6. Install the socket (together with the bulb) by turning it clockwise.
  7. Install the bulb cover.
  8. Install the passenger seat.
1. Remove the turn signal light lens by removing the screw.
  2. Remove the defective bulb by pushing it in and turning it counter-clockwise.
  3. Insert a new bulb into the socket, push it in, and then turn it clockwise until it stops.
  4. Install the lens by installing the screw.

# PERIODIC MAINTENANCE AND MINOR REPAIR

---

EAU01579

## Supporting the motorcycle

Since this model is not equipped with a centerstand, follow these precautions when removing the front and rear wheel or performing other maintenance requiring the motorcycle to stand upright. Check that the motorcycle is in a stable and level position before starting any maintenance. A strong wooden box can be placed under the engine for added stability.

## To service the front wheel

1. Stabilize the rear of the motorcycle by using a motorcycle stand or, if an additional motorcycle stand is not available, by placing a jack under the frame in front of the rear wheel.
2. Raise the front wheel off the ground by using a motorcycle stand.

## To service the rear wheel

Raise the rear wheel off the ground by using a motorcycle stand or, if a motorcycle stand is not available, by placing a jack either under each side of the frame in front of the rear wheel or under each side of the swingarm.

EAU01359

## Front wheel

### To remove the front wheel

EW000122

#### **WARNING**

- It is advisable to have a Yamaha dealer service the wheel.
- Securely support the motorcycle so that there is no danger of it falling over.

1. Remove cowling A. (See page 6-8 for removal and installation procedures.)

# PERIODIC MAINTENANCE AND MINOR REPAIR

EAU01380

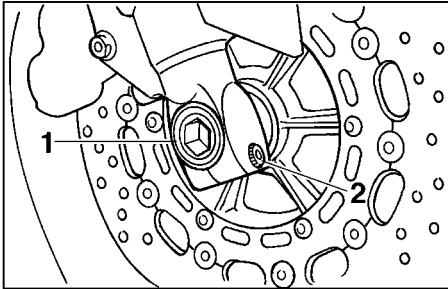

1. Wheel axle
2. Pinch bolt

2. Loosen the front wheel axle pinch bolt, then the wheel axle and the brake caliper bolts.
3. Lift the front wheel off the ground according to the procedure on page 6-43.

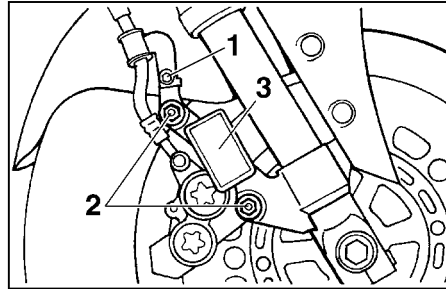

1. Brake hose holder bolt
2. Caliper bolt (× 2)
3. Reflector

4. Remove the brake hose holders by removing the bolts.
5. Remove the brake calipers and reflectors by removing the bolts.
6. Pull the wheel axle out, and then remove the wheel.

ECA00046

## **CAUTION:**

**Do not apply the brake after the brake calipers have been removed, otherwise the brake pads will be forced shut.**

## To install the front wheel

1. Lift the wheel up between the front fork legs.
2. Insert the wheel axle.
3. Lower the front wheel so that it is on the ground.
4. Push down hard on the handlebar several times to check for proper fork operation.
5. Install the brake calipers by installing the bolts.

## **NOTE:**

Make sure that there is enough space between the brake pads before installing the brake calipers onto the brake discs.

6. Install the brake calipers and reflectors by installing the bolts.
7. Install the front wheel axle pinch bolt, and then tighten the wheel axle, pinch bolt and brake caliper bolts to the specified torques.

# PERIODIC MAINTENANCE AND MINOR REPAIR

## Tightening torques:

### Wheel axle:

72 Nm (7.2 m·kg, 52 ft·lb)

### Front wheel axle pinch bolt:

23 Nm (2.3 m·kg, 17 ft·lb)

### Brake caliper bolt:

40 Nm (4.0 m·kg, 29 ft·lb)

## 8. Install cowling A.

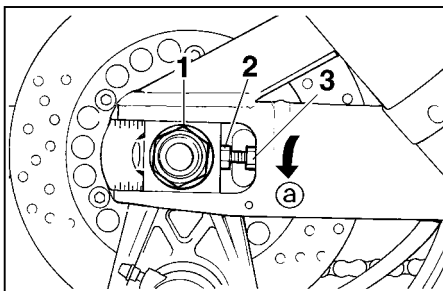

1. Rear wheel axle nut
2. Drive chain slack adjusting bolt
3. Locknut

EAU03537

## Rear wheel

### To remove the rear wheel

EW000122

### **! WARNING**

- It is advisable to have a Yamaha dealer service the wheel.
- Securely support the motorcycle so that there is no danger of it falling over.

1. Loosen the axle nut and the brake caliper bolts.
2. Lift the rear wheel off the ground according to the procedure on page 6-43.

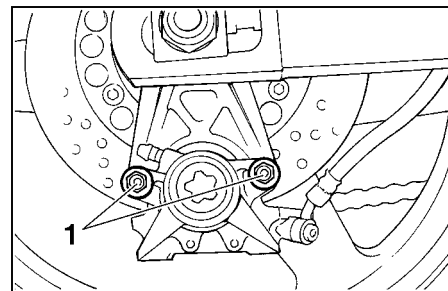

1. Caliper bolt (x 2)

3. Remove the axle nut, and then remove the brake caliper by removing the bolts.
4. Loosen the locknut on each side of the swingarm.
5. Turn the drive chain adjusting bolts fully in direction @.

# PERIODIC MAINTENANCE AND MINOR REPAIR

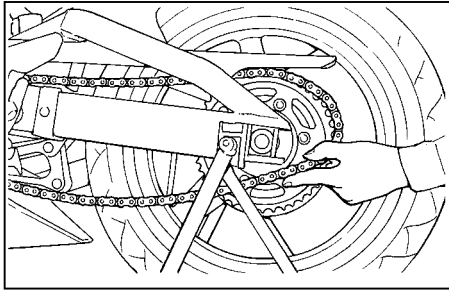

6. Push the wheel forward, and then remove the drive chain from the rear sprocket.

**NOTE:** \_\_\_\_\_  
The drive chain does not need to be disassembled in order to remove and install the rear wheel.

7. Pull the wheel axle out, and then remove the wheel.

ECA00048

**CAUTION:** \_\_\_\_\_  
**Do not apply the brake after the wheel has been removed together with the brake disc, otherwise the brake pads will be forced shut.**

EAU03538

## To install the rear wheel

1. Install the wheel by inserting the wheel axle from the left hand side.
2. Install the drive chain onto the rear sprocket, and then adjust the drive chain slack. (See page 6-31 for drive chain slack adjustment procedures.)
3. Install the axle nut, and then lower the rear wheel so that it is on the ground.
4. Install the brake caliper by installing the bolts.

**NOTE:** \_\_\_\_\_  
Make sure that there is enough space between the brake pads before installing the brake caliper onto the brake disc.

5. Tighten the axle nut and the brake caliper bolts to the specified torques.

### Tightening torques:

Axle nut:

150 Nm (15.0 m·kg, 110 ft·lb)

Brake caliper bolt:

40 Nm (4.0 m·kg, 29 ft·lb)

# PERIODIC MAINTENANCE AND MINOR REPAIR

---

EAU01008

## Troubleshooting

Although Yamaha motorcycles receive a thorough inspection before shipment from the factory, trouble may occur during operation. Any problem in the fuel, compression, or ignition systems, for example, can cause poor starting and loss of power.

The following troubleshooting chart represents a quick and easy procedure for checking these vital systems yourself. However, should your motorcycle require any repair, take it to a Yamaha dealer, whose skilled technicians have the necessary tools, experience, and know-how to service the motorcycle properly.

Use only genuine Yamaha replacement parts. Imitation parts may look like Yamaha parts, but they are often inferior, have a shorter service life and can lead to expensive repair bills.



# PERIODIC MAINTENANCE AND MINOR REPAIR

EAU02990

## Troubleshooting charts

### Starting problems or poor engine performance

EW000125



**WARNING**

**Keep away open flames and do not smoke while checking or working on the fuel system.**

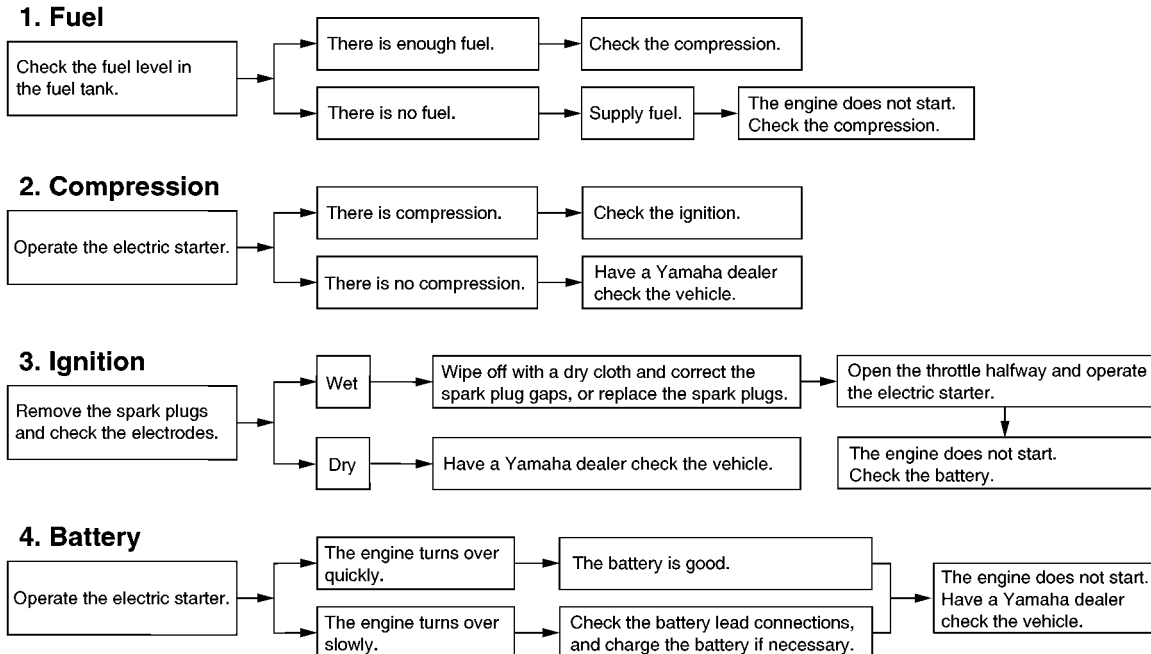

# PERIODIC MAINTENANCE AND MINOR REPAIR

## Engine overheating

EW000070

### **WARNING**

- Do not remove the radiator cap when the engine and radiator are hot. Scalding hot fluid and steam may be blown out under pressure, which could cause serious injury. Be sure to wait until the engine has cooled.
- After removing the radiator cap retaining bolt, place a thick rag, like a towel, over the radiator cap, and then slowly rotate the cap counterclockwise to the detent to allow any residual pressure to escape. When the hissing sound has stopped, press down on the cap while turning it counterclockwise, and then remove the cap.

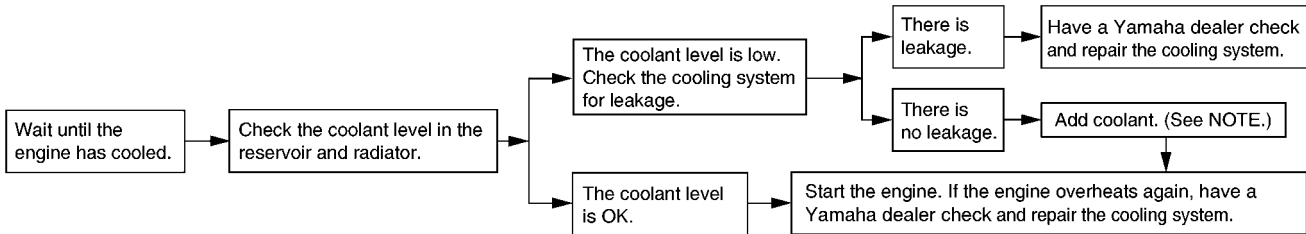

### **NOTE:**

If coolant is not available, tap water can be temporarily used instead, provided that it is changed to the recommended coolant as soon as possible.

# MOTORCYCLE CARE AND STORAGE

---

Care .....	7-1
Storage .....	7-4

## Care

While the open design of a motorcycle reveals the attractiveness of the technology, it also makes it more vulnerable. Rust and corrosion can develop even if high-quality components are used. A rusty exhaust pipe may go unnoticed on a car, however, it detracts from the overall appearance of a motorcycle. Frequent and proper care does not only comply with the terms of the warranty, but it will also keep your motorcycle looking good, extend its life and optimize its performance.

## Before cleaning

1. Cover the muffler outlet with a plastic bag after the engine has cooled down.
2. Make sure that all caps and covers as well as all electrical couplers and connectors, including the spark plug caps, are tightly installed.
3. Remove extremely stubborn dirt, like oil burnt onto the crankcase, with a degreasing agent and a brush, but never apply such products onto seals, gaskets, sprockets, the drive chain and wheel axles. Always rinse the dirt and degreaser off with water.

## Cleaning

ECA00056

### CAUTION:

- **Avoid using strong acidic wheel cleaners, especially on spoked wheels. If such products are used on hard-to-remove dirt, do not leave the cleaner on the affected area any longer than instructed. Also, thoroughly rinse the area off with water, immediately dry it, and then apply a corrosion protection spray.**
- **Improper cleaning can damage windshields, cowlings, panels, other plastic parts, and the muffler. Use only a soft, clean cloth or sponge with mild detergent and water to clean plastic. However, if the muffler cannot be thoroughly cleaned with mild detergent, alkaline products and a soft brush may be used.**

# MOTORCYCLE CARE AND STORAGE

- Do not use any harsh chemical products on plastic parts or the muffler. Be sure to avoid using cloths or sponges which have been in contact with strong or abrasive cleaning products, solvent or thinner, fuel (gasoline), rust removers or inhibitors, brake fluid, antifreeze or electrolyte.
- Do not use high-pressure washers or steam-jet cleaners since they cause water seepage and deterioration in the following areas: seals (of wheel and swing-arm bearings, fork and brakes), storage compartments, electric components (couplers, connectors, instruments, switches and lights), breather hoses and vents.

- For motorcycles equipped with a windshield: Do not use strong cleaners or hard sponges as they will cause dulling or scratching. Some cleaning compounds for plastic may leave scratches on the windshield. Test the product on a small hidden part of the windshield to make sure that it does not leave any marks. If the windshield is scratched, use a quality plastic polishing compound after washing.

## After normal use

Remove dirt with warm water, a mild detergent, and a soft, clean sponge, and then rinse thoroughly with clean water. Use a toothbrush or bottlebrush for hard-to-reach areas. Stubborn dirt and insects will come off more easily if the area is covered with a wet cloth for a few minutes before cleaning.

## After riding in the rain, near the sea or on salt-sprayed roads

Since sea salt or salt sprayed on roads during winter are extremely corrosive in combination with water, carry out the following steps after each ride in the rain, near the sea or on salt-sprayed roads.

## **NOTE:**

Salt sprayed on roads in the winter may remain well into spring.

1. Clean the motorcycle with cold water and a mild detergent, after the engine has cooled down.

ECA00012

## **CAUTION:**

**Do not use warm water since it increases the corrosive action of the salt.**

2. After drying the motorcycle, apply a corrosion protection spray on all metal, including chrome- and nickel-plated, surfaces (except the titanium muffler) to prevent corrosion.

# MOTORCYCLE CARE AND STORAGE

---

EWAA00031

## Cleaning the titanium muffler

This model is equipped with a titanium muffler, which requires the following special care.

- Use only a soft, clean cloth or sponge with mild detergent and water to clean the titanium muffler. However, if the muffler cannot be thoroughly cleaned with mild detergent, alkaline products and a soft brush may be used.
- Never use compounds or other special treatments to clean the titanium muffler, as they will remove the finish on the outer surface of the muffler.
- Even the smallest amounts of oil, such as from oily towels or fingerprints, will leave stains on the titanium muffler, which can be removed with a mild detergent.
- Note that the thermally induced discoloring of the portion of the exhaust pipe leading into the titanium muffler is normal and cannot be removed.

## **After cleaning**

1. Dry the motorcycle with a chamois or an absorbing cloth.
2. Immediately dry the drive chain and lubricate it to prevent it from rusting.
3. Use a chrome polish to shine chrome, aluminum and stainless-steel parts.
4. To prevent corrosion, it is recommended to apply a corrosion protection spray on all metal, including chrome- and nickel-plated, surfaces.
5. Use spray oil as a universal cleaner to remove any remaining dirt.
6. Touch up minor paint damage caused by stones, etc.
7. Wax all painted surfaces.
8. Let the motorcycle dry completely before storing or covering it.

## **⚠ WARNING**

- **Make sure that there is no oil or wax on the brakes or tires.**
  - **If necessary, clean the brake discs and brake linings with a regular brake disc cleaner or acetone, and wash the tires with warm water and a mild detergent. Before riding at higher speeds, test the motorcycle's braking performance and cornering behavior.**
-

# MOTORCYCLE CARE AND STORAGE

ECA00013

## CAUTION:

- Apply spray oil and wax sparingly and make sure to wipe off any excess.
- Never apply oil or wax to any rubber and plastic parts, but treat them with a suitable care product.
- Avoid using abrasive polishing compounds as they will wear away the paint.

## NOTE:

Consult a Yamaha dealer for advice on what products to use.

## Storage

### Short-term

Always store your motorcycle in a cool, dry place and, if necessary, protect it against dust with a porous cover.

ECA00014

## CAUTION:

- Storing the motorcycle in a poorly ventilated room or covering it with a tarp, while it is still wet, will allow water and humidity to seep in and cause rust.
- To prevent corrosion, avoid damp cellars, stables (because of the presence of ammonia) and areas where strong chemicals are stored.

## Long-term

Before storing your motorcycle for several months:

1. Follow all the instructions in the “Care” section of this chapter.
2. For motorcycles equipped with a fuel cock that has an “OFF” position: Turn the fuel cock lever to “OFF”.
3. Drain the carburetor float chamber by loosening the drain bolt; this will prevent fuel deposits from building up. Pour the drained fuel into the fuel tank.
4. Fill up the fuel tank and add fuel stabilizer (if available) to prevent the fuel tank from rusting and the fuel from deteriorating.
5. Perform the following steps to protect the cylinders, piston rings, etc. from corrosion.

# MOTORCYCLE CARE AND STORAGE

---

- a. Remove the spark plug caps and spark plugs.
  - b. Pour a teaspoonful of engine oil into each spark plug bore.
  - c. Install the spark plug caps onto the spark plugs, and then place the spark plugs on the cylinder head so that the electrodes are grounded. (This will limit sparking during the next step.)
  - d. Turn the engine over several times with the starter. (This will coat the cylinder walls with oil.)
  - e. Remove the spark plug caps from the spark plugs, and then install the spark plugs and the spark plug caps.
6. Lubricate all control cables and the pivoting points of all levers and pedals as well as of the sidestand/centerstand.
  7. Check and, if necessary, correct the tire air pressure, and then lift the motorcycle so that both of its wheels are off the ground. Alternatively, turn the wheels a little every month in order to prevent the tires from becoming degraded in one spot.
  8. Cover the muffler outlet with a plastic bag to prevent moisture from entering it.
9. Remove the battery and fully charge it. Store it in a cool, dry place and charge it once a month. Do not store the battery in an excessively cold or warm place [less than 0°C (30°F) or more than 30°C (90°F)]. For more information on storing the battery, see page 6-38.

**NOTE:** \_\_\_\_\_  
Make any necessary repairs before storing the motorcycle.  
\_\_\_\_\_

EWA00003

## **WARNING**

**To prevent damage or injury from sparking, make sure to ground the spark plug electrodes while turning the engine over.**

---



Specifications ..... 8-1

## Specifications

<b>Model</b>	<b>YZF-R1/YZF-R1C</b>
<b>Dimensions</b>	
Overall length	2,035 mm (80.1 in)
Overall width	695 mm (27.4 in)
Overall height	1,105 mm (43.1 in)
Seat height	815 mm (32.1 in)
Wheelbase	1,395 mm (54.9 in)
Ground clearance	140 mm (5.5 in)
Minimum turning radius	3,400 mm (133.9 in)
<b>Basic weight (with oil and full fuel tank)</b>	
	194 kg (428 lb) YZF-R1
	195 kg (430 lb) YZF-R1C
<b>Engine</b>	
Engine type	Liquid-cooled 4-stroke, DOHC
Cylinder arrangement	Forward-inclined parallel 4-cylinder
Displacement	998 cm <sup>3</sup>
Bore × Stroke	74 × 58 mm (2.91 × 2.28 in)
Compression ratio	11.8:1
Starting system	Electric starter
Lubrication system	Wet sump

## Engine oil

### Type

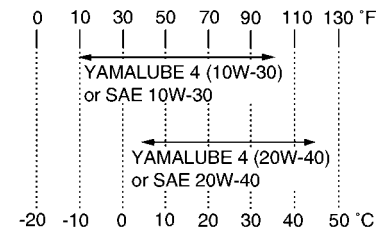

Recommended engine oil classification

API Service SE, SF, SG type or higher

### CAUTION:

**Be sure to use motor oils that do not contain anti-friction modifiers. Passenger car motor oils (often labeled "ENERGY CONSERVING II") contain anti-friction additives which will cause clutch and/or starter clutch slippage, resulting in reduced component life and poor engine performance.**

### Quantity

Without oil filter cartridge replacement	2.7 L (2.38 Imp qt, 2.85 US qt)
With oil filter cartridge replacement	2.9 L (2.55 Imp qt, 3.07 US qt)
Total amount (dry engine)	3.6 L (3.17 Imp qt, 3.81 US qt)

# SPECIFICATIONS

## Cooling system capacity (total amount)

2.55 L (2.24 Imp qt, 2.7 US qt)

## Air filter

Dry type element

## Fuel

Type Unleaded fuel  
 Fuel tank capacity 18 L (3.96 Imp gal, 4.76 US gal)  
 Fuel reserve amount 3.8 L (0.84 Imp gal, 1.00 US gal)

## Carburetor

Manufacturer MIKUNI  
 Model × quantity BDSR40 × 4

## Spark plug

Manufacturer/model NGK / CR9E or  
 DENSO / U27ESR-N  
 Gap 0.7–0.8 mm (0.028–0.031 in)

## Clutch type

Wet, multiple-disc

## Transmission

Primary reduction system Spur gear  
 Primary reduction ratio 1.581  
 Secondary reduction system Chain drive  
 Secondary reduction ratio 2.688  
 Number of drive chain sprocket teeth (front/rear) 16/43  
 Transmission type Constant-mesh 6-speed  
 Operation Left foot

## Gear ratio

1st	2.500
2nd	1.842
3rd	1.500
4th	1.333
5th	1.200
6th	1.115

## Chassis

Frame type Diamond  
 Caster angle 24°  
 Trail 92 mm (3.62 in)

## Tires

Front  
 Type Tubeless  
 Size 120/70 ZR17 (58 W)  
 Manufacturer/model Metzeler / MEZ3Y Front  
 Dunlop / D207FQ  
 Rear  
 Type Tubeless  
 Size 190/50 ZR17 (73 W)  
 Manufacturer/model Metzeler / MEZ3Y  
 Dunlop / D207N

# SPECIFICATIONS

Maximum load*	201 kg (443 lb) YZF-R1
	200 kg (441 lb) YZF-R1C
Tire air pressure (measured on cold tires)	
Up to 90 kg (198 lb)*	
Front	250 kPa (2.50 kgf/cm <sup>2</sup> , 36 psi)
Rear	250 kPa (2.50 kgf/cm <sup>2</sup> , 36 psi)
90 kg (198 lb)– maximum*	
Front	250 kPa (2.50 kgf/cm <sup>2</sup> , 36 psi)
Rear	290 kPa (2.90 kgf/cm <sup>2</sup> , 42 psi)
High-speed riding	
Front	250 kPa (2.50 kgf/cm <sup>2</sup> , 36 psi)
Rear	250 kPa (2.50 kgf/cm <sup>2</sup> , 36 psi)

\* Total weight of rider, passenger, cargo and accessories

## Wheels

Front	
Type	Cast wheel
Size	17 × MT 3.50
Rear	
Type	Cast wheel
Size	17 × MT 6.00

## Brakes

Front	
Type	Dual disc brake
Operation	Right hand
Fluid	DOT 4
Rear	
Type	Single disk brake
Operation	Right foot
Fluid	DOT 4

## Suspension

Front	Telescopic fork
Rear	Swingarm (link suspension)

## Spring/shock absorber

Front	Coil spring / oil damper
Rear	Coil spring / gas-oil damper

## Wheel travel

Front	135 mm (5.31 in)
Rear	130 mm (5.12 in)

## Electrical system

Ignition system	Transistorized coil ignition (digital)
Charging system	
Type	A.C. magneto
Standard output	14 V, 365 W@ 5,000 r/min
Battery	
Model	GT12B-4
Voltage, capacity	12 V, 10 Ah

## Headlight type

Quartz bulb (halogen)

## Bulb voltage, wattage × quantity

Headlight	12 V, 60/55 W × 2
Tail/brake light	12 V, 5/21 W × 2
Front turn signal/position light	12 V, 27/8 W × 2
Rear turn signal light	12 V, 27 W × 2
Meter lighting	12 V, 5 W × 2
Neutral indicator light	LED
High beam indicator light	LED
Turn signal indicator light	LED
Fuel level warning light	LED
Oil level warning light	LED

## Fuses

Main fuse	30 A
Headlight fuse	20 A
Signaling system fuse	20 A
Radiator fan fuse	10 A
Ignition fuse	15 A
Odometer fuse	10 A



# CONSUMER INFORMATION

Identification numbers .....	9-1
Key identification number .....	9-1
Vehicle identification number .....	9-1
Model label .....	9-2
Reporting safety defects .....	9-3
Motorcycle noise regulation .....	9-4
Maintenance record .....	9-5
STREET AND ENDURO MOTORCYCLE LIMITED WARRANTY ....	9-7
YAMAHA EXTENDED SERVICE (Y.E.S.) .....	9-9

EAU02944

## Identification numbers

Record the key identification number, vehicle identification number and model label information in the spaces provided below for assistance when ordering spare parts from a Yamaha dealer or for reference in case the vehicle is stolen.

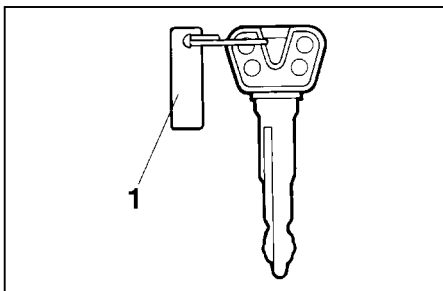

1. Key identification number

EAU01041

## Key identification number

The key identification number is stamped into the key tag. Record this number in the space provided and use it for reference when ordering a new key.

### 1. KEY IDENTIFICATION NUMBER:

### 2. VEHICLE IDENTIFICATION NUMBER:

### 3. MODEL LABEL INFORMATION:

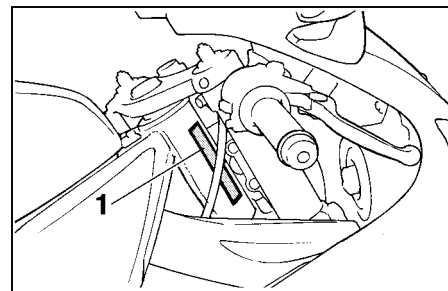

1. Vehicle identification number

EAU01043

## Vehicle identification number

The vehicle identification number is stamped into the steering head pipe. Record this number in the space provided.

**NOTE:** \_\_\_\_\_  
The vehicle identification number is used to identify your motorcycle and may be used to register your motorcycle with the licensing authority in your area.



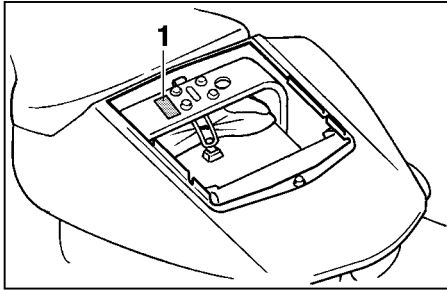

1. Model label

EAU03171

## Model label

The model label is affixed to the frame under the passenger seat. (See page 3-13 for seat removal and installation procedures.) Record the information on this label in the space provided. This information will be needed when ordering spare parts from a Yamaha dealer.

# CONSUMER INFORMATION

---

EAU01051

## Reporting safety defects

If you believe that your vehicle has a defect which could cause a crash or could cause injury or death, you should immediately inform the National Highway Traffic Safety Administration (NHTSA) in addition to notifying Yamaha Motor Corporation, U.S.A. If NHTSA receives similar complaints, it may open an investigation, and if it finds that a safety defect exists in a group of vehicles, it may order a recall and remedy campaign. However, NHTSA cannot become involved in individual problems between you, your dealer, or Yamaha Motor Corporation, U.S.A.

To contact NHTSA, you may either call the Auto Safety Hotline toll-free at 1-800-424-9393 (or 366-0123 in Washington, D.C. area) or write to: NHTSA, U.S. Department of Transportation, Washington, D.C. 20590. You can also obtain other information about motor vehicle safety from the Hotline.

## Motorcycle noise regulation

### TAMPERING WITH NOISE CONTROL SYSTEM PROHIBITED:

Federal law prohibits the following acts or the causing thereof: (1) The removal or rendering inoperative by any person other than for purposes of maintenance, repair, or replacement of any device or element of design incorporated into any new vehicle for the purpose of noise control prior to its sale or delivery to the ultimate purchaser or while it is in use or (2) the use of the vehicle after such device or element of design has been removed or rendered inoperative by any person.

“AMONG THOSE ACTS PRESUMED TO CONSTITUTE TAMPERING ARE THE ACTS LISTED BELOW”.

These acts include tampering with the following systems; i.e., modification, removal, etc.

Exhaust system	Muffler Exhaust pipe Silencer
Intake system	Air cleaner case Air cleaner element Intake duct

# CONSUMER INFORMATION

EAU01874

## Maintenance record

Copies of work orders and/or receipts for parts purchased and installed on your motorcycle will be required to document that maintenance has been completed in accordance with the emissions warranty. The chart below is printed only as a reminder that maintenance work is required. It is not acceptable proof of maintenance work.

Maintenance interval	Date of service	Mileage	Servicing dealer name and address	Remarks
600 mi (1,000 km) or 1 month				
4,000 mi ( 7,000 km) or 6 months				
8,000 mi (13,000 km) or 12 months				
12,000 mi (19,000 km) or 18 months				
16,000 mi (25,000 km) or 24 months				
20,000 mi (31,000 km) or 30 months				
24,000 mi (37,000 km) or 36 months				

# CONSUMER INFORMATION

<b>Maintenance interval</b>	<b>Date of service</b>	<b>Mileage</b>	<b>Servicing dealer name and address</b>	<b>Remarks</b>
28,000 mi (43,000 km) or 42 months				
32,000 mi (49,000 km) or 48 months				
36,000 mi (55,000 km) or 54 months				
40,000 mi (61,000 km) or 60 months				

## YAMAHA MOTOR CORPORATION, U.S.A. STREET AND ENDURO MOTORCYCLE LIMITED WARRANTY

Yamaha Motor Corporation, U.S.A. hereby warrants each new model Yamaha motorcycle will be free from defects in material and workmanship for the period of time stated herein, subject to certain stated limitations.

**THE PERIOD OF WARRANTY** for Yamaha motorcycles originally equipped with headlight, stoplight, and turn signals shall be one (1) year from the date of purchase, with no mileage limitation.

**MODELS EXCLUDED FROM WARRANTY** include those used for non-Yamaha-authorized renting, leasing, or other commercial purposes, and TZ models.

**DURING THE PERIOD OF WARRANTY** any authorized Yamaha motorcycle dealer will, free of charge, repair or replace any part adjudged defective by Yamaha due to faulty workmanship or material from the factory. Parts used in warranty repairs will be warranted for the balance of the product's warranty period. All parts replaced under warranty become property of Yamaha Motor Corp. U.S.A.

**GENERAL EXCLUSIONS** from this warranty shall include any failures caused by:

- Competition or racing use.
- Installation of parts or accessories that are not qualitatively equivalent to genuine Yamaha parts.
- Abnormal strain, neglect, or abuse.
- Lack of proper maintenance.
- Accident or collision damage.
- Modification to original parts.

**SPECIFIC EXCLUSIONS** from this warranty shall include parts replaced due to normal wear or routine maintenance.

**THE CUSTOMER'S RESPONSIBILITY** under this warranty shall be to:

- Operate and maintain the motorcycle as specified in the appropriate Owner's Manual, and
- Give notice to an authorized Yamaha motorcycle dealer of any and all apparent defects within ten (10) days after discovery, and make the machine available at that time for inspection and repairs at such dealer's place of business.

**WARRANTY TRANSFER:** To transfer the warranty from the original purchaser to any subsequent purchaser, it is imperative that the machine be inspected and registered for warranty by an authorized Yamaha motorcycle dealer. In order for this warranty to remain in effect, this inspection and registration must take place within ten (10) days after transfer. An inspection and registration fee will be charged for this service.

### EMISSIONS CONTROL SYSTEM WARRANTY

Yamaha Motor Corporation, U.S.A. also warrants to the ultimate purchaser and each subsequent purchaser of each Yamaha motorcycle covered by this warranty with a displacement of 50cc or greater, that the vehicle is designed, built, and equipped so as to conform at the time of sale with all U.S. emissions standards applicable at the time of manufacture and that it is free from defects in materials and workmanship which would cause it not to meet these standards within the periods listed immediately below. Failure other than those resulting from defects in material or workmanship which arise solely as a result of owner abuse and/or lack of proper maintenance are not covered by this warranty.

ENGINE DISPLACEMENT	PERIOD
50cc to 169cc	12,000 km (7,465 miles) or five years, whichever occurs first
170cc to 279cc	18,000 km (11,185 miles) or five years, whichever occurs first
280cc or over	30,000 km (18,641 miles) or five years, whichever occurs first

**YAMAHA MOTOR CORPORATION, U.S.A. MAKES NO OTHER WARRANTY OF ANY KIND, EXPRESSED OR IMPLIED. ALL IMPLIED WARRANTIES OF MERCHANTABILITY AND FITNESS FOR A PARTICULAR PURPOSE WHICH EXCEED THE OBLIGATIONS AND TIME LIMITS STATED IN THIS WARRANTY ARE HEREBY DISCLAIMED BY YAMAHA MOTOR CORPORATION, U.S.A. AND EXCLUDED FROM THIS WARRANTY.**

**SOME STATES DO NOT ALLOW LIMITATIONS ON HOW LONG AN IMPLIED WARRANTY LASTS, SO THE ABOVE LIMITATION MAY NOT APPLY TO YOU. ALSO EXCLUDED FROM THIS WARRANTY ARE ANY INCIDENTAL OR CONSEQUENTIAL DAMAGES INCLUDING LOSS OF USE. SOME STATES DO NOT ALLOW THE EXCLUSION OR LIMITATION OF INCIDENTAL OR CONSEQUENTIAL DAMAGES, SO THE ABOVE EXCLUSION MAY NOT APPLY TO YOU.**

**THIS WARRANTY GIVES YOU SPECIFIC LEGAL RIGHTS, AND YOU MAY ALSO HAVE OTHER RIGHTS WHICH VARY FROM STATE TO STATE.**

YAMAHA MOTOR CORPORATION, U.S.A.  
P.O. Box 6555  
Cypress, California 90630

## WARRANTY QUESTIONS AND ANSWERS

- Q. What costs are my responsibility during the warranty period?
- A. The customer's responsibility includes all costs of normal maintenance services, non-warranty repairs, accident and collision damages, and oil, oil filters, air filters, spark plugs, and brake shoes.
- Q. What are some examples of "abnormal" strain, neglect, or abuse?
- A. These terms are general and overlap each other in areas. Specific examples include: Running the machine out of oil, sustained high-rpm, full-throttle, operating the machine with a broken or damaged part which causes another part to fail, damage or failure due to improper or careless transportation and or tie down. If you have any specific questions on operation or maintenance, please contact your dealer for advice.
- Q. Does the warranty cover incidental costs such as towing or transportation due to a failure?
- A. No. The warranty is limited to repair of the machine itself.
- Q. May I perform any or all of the recommended maintenance shown in the Owner's Manual instead of having the dealer do them?
- A. Yes, if you are a qualified mechanic and follow the procedures specified in the Owner's and Service Manual. We do recommend, however, that items requiring special tools or equipment be done by Yamaha Motorcycle dealer.
- Q. Will the warranty be void or cancelled if I do not operate or maintain my new motorcycle exactly as specified in the Owner's Manual?
- A. No. The warranty on a new motorcycle cannot be "voided" or "cancelled." **However, if a particular failure is caused by operation or maintenance other than as shown in the Owner's Manual, that failure may not be covered under warranty.**
- Q. What responsibility does my dealer have under this warranty?
- A. Each Yamaha Motorcycle dealer is expected to:
1. Completely set up every new machine before sale.
  2. Explain the operation, maintenance, and warranty requirements to your satisfaction at the time of sale, and upon your request at any later date.
  3. Each Yamaha Motorcycle dealer is held responsible for his setup, service and warranty repair work.
- Q. Is the warranty transferable to second owners?
- A. Yes. The remainder of the existing warranty can be transferred upon request. The unit has to be inspected and re-registered by an authorized Yamaha Motorcycle dealer for the policy to remain effective.

## CUSTOMER SERVICE

If your machine requires warranty service, you must take it to any authorized Yamaha Motorcycle dealer within the continental United States. Be sure to bring your warranty registration card or other valid proof of the original date of purchase. If a question or problem arises regarding warranty, first contact the owner of the dealership. Since all warranty matters are handled at the dealer level, this person is in the best position to help you. If you are still not satisfied and require additional assistance, please write:

YAMAHA MOTOR CORPORATION U.S.A.  
CUSTOMER RELATIONS DEPARTMENT  
P.O. Box 6555  
Cypress, California 90630

When contacting Yamaha Motor Corporation, U.S.A. don't forget to include any important information such as names, addresses, model, V.I.N. (frame number), dates, and receipts.

## CHANGE OF ADDRESS

The federal government requires each manufacturer of a motor vehicle to maintain a complete, up-to-date list of all first purchasers against the possibility of a safety-related defect and recall. This list is compiled from the purchase registrations sent to Yamaha Motor Corporation, U.S.A. by the selling dealer at the time of your purchase.

If you should move after you have purchased your new motorcycle, please advise us of your new address by sending a postcard listing your motorcycle model name, V.I.N. (frame number), dealer number (or dealer's name) as it is shown on your warranty card, your name and new mailing address. Mail to:

YAMAHA MOTOR CORPORATION, U.S.A.  
P.O. Box 6555  
Cypress, California 90630  
Attention: Warranty Department

This will ensure that Yamaha Motor Corporation, U.S.A. has an up-to-date registration record in accordance with federal law.

## YAMAHA EXTENDED SERVICE (Y.E.S.)

Keep your Yamaha protected even after your warranty expires with genuine Yamaha Extended Service (Y.E.S.).

- Y.E.S. is designed and administered by Yamaha Motor Corporation to provide maximum owner satisfaction. You get uninterrupted factory-backed coverage for extra peace of mind.
- Y.E.S. is flexible. You choose the plan that's right for you: 12 months, 24 months, or 36 months beyond your warranty period.
- Y.E.S. is designed and administered by the same Yamaha people who handle your warranty – and it shows in the comprehensive coverage benefits. There are no mileage limitations. Coverage isn't limited to "moving parts" or the "drive train" like many other plans. And Y.E.S. covers manufacturing defects just like the warranty. See the sample contract at your Yamaha dealer to see how comforting uninterrupted factory-backed protection can be.
- You don't have to pay anything for covered repairs. There's no deductible to pay, and repairs aren't "pro-rated." You don't have any "out-of-pocket" expenses for covered repairs.
- In addition, Travel and Recreation Interruption Protection (TRIP) is included at no extra cost. TRIP gives you up to \$150 reimbursement per occurrence for any reasonable expenses you incur because your Yamaha needs covered service: replacement vehicle rental, emergency towing, phone calls, even food and lodging when you are away from home. This superb coverage goes into effect when you purchase Y.E.S., so it applies to any warranty repairs as well as covered repairs during your entire Y.E.S. plan period.
- Y.E.S. coverage is honored at any authorized Yamaha dealer nationwide.
- Y.E.S. coverage is transferable to a new owner if you sell or trade-in. That can make your Yamaha much more valuable!

This excellent Y.E.S. plan coverage is only available to Yamaha owners like you, and only while your Yamaha is still within the Yamaha Limited Warranty period. So visit your authorized Yamaha dealer to get all the facts. He can show you how easy it is to protect your investment with Yamaha Extended Service.



## CONSUMER INFORMATION

---

We urge you to act now. You'll get the excellent benefits of TRIP coverage right away, and you'll rest easy knowing you'll have strong factory-backed protection even after your Yamaha Limited Warranty expires. You can also save money: Y.E.S. costs less within the first 90 days after you buy your Yamaha. See your dealer today!

A special note:

If visiting your dealer isn't convenient, contact Yamaha with your Primary ID number (your frame number). We'll be happy to help you get the Y.E.S. coverage you need.

Yamaha Service Marketing  
P.O. Box 6555  
Cypress, CA 90630

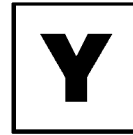

**YAMAHA EXTENDED SERVICE**

# INDEX

<b>A</b>	
Accessories and replacement parts .....	6-25
Air filter element, cleaning .....	6-19
<b>B</b>	
Battery .....	6-38
Brake and clutch levers, checking and lubricating .....	6-34
Brake fluid, changing .....	6-30
Brake fluid level, checking .....	6-29
Brake lever .....	3-9
Brake light switch (rear), adjusting .....	6-27
Brake pads, checking .....	6-28
Brake pedal .....	3-10
Brake pedal, lubricating .....	6-34
Brake pedal position, adjusting .....	6-27
<b>C</b>	
Cables, checking and lubricating .....	6-33
Canister (for California only) .....	6-11
Carburetors, adjusting .....	6-21
Care .....	7-1
Clutch lever .....	3-9
Clutch lever free play, adjusting .....	6-26
Coolant .....	6-15
Changing .....	6-16
Checking .....	6-15
Coolant temperature warning light .....	3-3
Cowlings and panels, removing and installing .....	6-8
<b>D</b>	
Dimmer switch .....	3-7
Drive chain, lubricating .....	6-32

Drive chain slack .....	6-31
Adjusting .....	6-31
Checking .....	6-31
<b>E</b>	
Engine break-in .....	5-5
Engine oil and oil filter cartridge .....	6-12
Engine stop switch .....	3-8
EXUP system .....	3-20
<b>F</b>	
Front and rear suspension settings .....	3-19
Front fork, adjusting .....	3-15
Front fork, checking .....	6-36
Fuel .....	3-11
Fuel level warning light .....	3-2
Fuel tank cap .....	3-10
Fuses, replacing .....	6-39
<b>H</b>	
Handlebar switches .....	3-7
Headlight bulb, replacing .....	6-40
Helmet holders .....	3-13
High beam indicator light .....	3-2
Horn switch .....	3-8
<b>I</b>	
Identification numbers .....	9-1
Ignition circuit cut-off system .....	3-21
Indicator and warning lights .....	3-2
<b>K</b>	
Key identification number .....	9-1
<b>L</b>	
Labels, location .....	1-7

Luggage strap holders .....	3-20
<b>M</b>	
Main switch/steering lock .....	3-1
Maintenance and lubrication, periodic .....	6-5
Maintenance, emission control system .....	6-3
Maintenance, periodic .....	6-1
Maintenance record .....	9-5
Model label .....	9-2
<b>N</b>	
Neutral indicator light .....	3-2
Noise regulation .....	9-4
<b>O</b>	
Oil level warning light .....	3-2
<b>P</b>	
Parking .....	5-6
Part locations .....	2-1
Pre-operation check list .....	4-1
<b>S</b>	
Safety defects, reporting .....	9-3
Safety information .....	1-1
Seats .....	3-12
Passenger seat .....	3-13
Rider seat .....	3-12
Self-diagnosis devices .....	3-7
Shifting .....	5-3
Decelerating .....	5-4
Shift points .....	5-4
Starting out and accelerating .....	5-4
Shift pedal .....	3-9
Shock absorber assembly, adjusting .....	3-17

Sidestand .....	3-21
Sidestand, checking and lubricating.....	6-35
Spark plugs, checking .....	6-10
Specifications .....	8-1
Speedometer unit.....	3-5
Starter (choke) lever.....	3-12
Starting and warming up a cold engine....	5-1
Starting a warm engine.....	5-3
Start switch.....	3-8
Steering, checking.....	6-37
Storage.....	7-4
Storage compartment.....	3-14
Supporting the motorcycle.....	6-43
Suspension (rear), lubricating .....	6-35

## T

Tachometer .....	3-6
Tail/brake light bulb, replacing .....	6-41
Throttle cable free play, adjusting .....	6-21
Throttle grip and cable, checking and lubricating.....	6-33
Tires .....	6-22
Tool kit.....	6-1
Troubleshooting.....	6-47
Troubleshooting charts .....	6-48
Turn signal indicator light.....	3-2
Turn signal light bulb, replacing .....	6-42
Turn signal switch.....	3-8

## V

Valve clearance, adjusting.....	6-21
Vehicle identification number .....	9-1

## W

Warranty, extended.....	9-9
Warranty limited .....	9-7
Wheel bearings, checking .....	6-37
Wheel (front) .....	6-43
Installing .....	6-44
Removing .....	6-43
Wheel (rear) .....	6-45
Installing .....	6-46
Removing .....	6-45
Wheels.....	6-25

**PROTECT YOUR INVESTMENT**

Use **Genuine YAMAHA** Parts And Accessories

**See your Authorized YAMAHA Dealer for a Genuine YAMAHA  
Service Manual.**



**YAMAHA**

YAMAHA MOTOR CO., LTD.

PRINTED ON RECYCLED PAPER

Download from [Www.Somanuals.com](http://Www.Somanuals.com). All Manuals Search And Download.

PRINTED IN JAPAN  
2000 · 7 - 4.0 × 1 CR  
(E)

## Free Manuals Download Website

<http://myh66.com>

<http://usermanuals.us>

<http://www.somanuals.com>

<http://www.4manuals.cc>

<http://www.manual-lib.com>

<http://www.404manual.com>

<http://www.luxmanual.com>

<http://aubethermostatmanual.com>

Golf course search by state

<http://golfingnear.com>

Email search by domain

<http://emailbydomain.com>

Auto manuals search

<http://auto.somanuals.com>

TV manuals search

<http://tv.somanuals.com>