



OWNER'S MANUAL

FJR

**FJR1300T(C)
FJR1300AT(C)**

LIT-11626-18-22

Download from www.Somanuals.com. All Manuals Search And Download.

5JW-28199-12

EAU10041

 **WARNING**

The engine exhaust from this product contains chemicals known to the State of California to cause cancer, birth defects or other reproductive harm.

YAMAHA

LIT-CALIF-65-01

Congratulations on your purchase of the Yamaha FJR1300T(C)/FJR1300AT(C). This model is the result of Yamaha's vast experience in the production of fine sporting, touring, and pacesetting racing machines. It represents the high degree of craftsmanship and reliability that have made Yamaha a leader in these fields.



This manual will give you an understanding of the operation, inspection, and basic maintenance of this motorcycle. If you have any questions concerning the operation or maintenance of your motorcycle, please consult a Yamaha dealer.

The design and manufacture of this Yamaha motorcycle fully comply with the emissions standards for clean air applicable at the date of manufacture. Yamaha has met these standards without reducing the performance or economy of operation of the motorcycle. To maintain these high standards, it is important that you and your Yamaha dealer pay close attention to the recommended maintenance schedules and operating instructions contained within this manual.

IMPORTANT MANUAL INFORMATION

EAU10130

Particularly important information is distinguished in this manual by the following notations:

| | |
|--|--|
|  | The Safety Alert Symbol means ATTENTION! BECOME ALERT! YOUR SAFETY IS INVOLVED! |
|  | Failure to follow WARNING instructions could result in severe injury or death to the motorcycle operator, a bystander or a person inspecting or repairing the motorcycle. |
| CAUTION: | A CAUTION indicates special precautions that must be taken to avoid damage to the motorcycle. |
| NOTE: | A NOTE provides key information to make procedures easier or clearer. |

NOTE:

- This manual should be considered a permanent part of this motorcycle and should remain with it even if the motorcycle is subsequently sold.
- Yamaha continually seeks advancements in product design and quality. Therefore, while this manual contains the most current product information available at the time of printing, there may be minor discrepancies between your motorcycle and this manual. If you have any questions concerning this manual, please consult your Yamaha dealer.

EWA10010

WARNING

PLEASE READ THIS MANUAL AND THE “YOU AND YOUR MOTORCYCLE: RIDING TIPS” BOOKLET CAREFULLY AND COMPLETELY BEFORE OPERATING THIS MOTORCYCLE. DO NOT ATTEMPT TO OPERATE THIS MOTORCYCLE UNTIL YOU HAVE ATTAINED ADEQUATE KNOWLEDGE OF ITS CONTROLS AND OPERATING FEATURES

IMPORTANT MANUAL INFORMATION

AND UNTIL YOU HAVE BEEN TRAINED IN SAFE AND PROPER RIDING TECHNIQUES. REGULAR INSPECTIONS AND CAREFUL MAINTENANCE, ALONG WITH GOOD RIDING SKILLS, WILL ENSURE THAT YOU SAFELY ENJOY THE CAPABILITIES AND THE RELIABILITY OF THIS MOTORCYCLE.

IMPORTANT MANUAL INFORMATION

EAU10192

AFFIX DEALER
LABEL HERE

**FJR1300T(C)/FJR1300AT(C)
OWNER'S MANUAL
©2004 by Yamaha Motor Corporation, U.S.A.
1st edition, April 2004
All rights reserved.
Any reprinting or unauthorized use
without the written permission of
Yamaha Motor Corporation, U.S.A.
is expressly prohibited.
Printed in Japan.
P/N LIT-11626-18-22**

TABLE OF CONTENTS

| | | | | | |
|---|------|---|------|---|------|
| SAFETY INFORMATION | 1-1 | Locks for the optional side cases and travel trunk | 3-16 | Adjusting the throttle cable free play | 6-18 |
| Location of important labels | 1-5 | Sidestand | 3-16 | Adjusting the valve clearance | 6-19 |
| DESCRIPTION | 2-1 | Ignition circuit cut-off system | 3-17 | Tires | 6-19 |
| Left view | 2-1 | PRE-OPERATION CHECKS | 4-1 | Cast wheels | 6-22 |
| Right view | 2-2 | Pre-operation check list | 4-2 | Accessories and replacement parts | 6-22 |
| Controls and instruments | 2-3 | OPERATION AND IMPORTANT RIDING POINTS | 5-1 | Clutch lever free play | 6-23 |
| INSTRUMENT AND CONTROL FUNCTIONS | 3-1 | Starting the engine | 5-1 | Adjusting the rear brake light switch | 6-23 |
| Main switch/steering lock | 3-1 | Shifting | 5-2 | Checking the front and rear brake pads | 6-23 |
| Indicator and warning lights | 3-2 | Engine break-in | 5-3 | Checking the brake and clutch fluid levels | 6-24 |
| Speedometer | 3-3 | Parking | 5-4 | Changing the brake and clutch fluids | 6-25 |
| Tachometer | 3-3 | PERIODIC MAINTENANCE AND MINOR REPAIR | 6-1 | Checking and lubricating the cables | 6-26 |
| Multi-function display | 3-4 | PERIODIC MAINTENANCE | 6-1 | Checking and lubricating the throttle grip and cable | 6-26 |
| Handlebar switches | 3-5 | Owner's tool kit | 6-1 | Checking and lubricating the brake and shift pedals | 6-26 |
| Clutch lever | 3-7 | Periodic maintenance chart for the emission control system | 6-3 | Checking and lubricating the brake and clutch levers | 6-27 |
| Shift pedal | 3-7 | General maintenance and lubrication chart | 6-4 | Checking and lubricating the centerstand and sidestand | 6-28 |
| Brake lever | 3-8 | Removing and installing panels | 6-8 | Lubricating the rear suspension ... | 6-28 |
| Brake pedal | 3-8 | Checking the spark plugs | 6-10 | Checking the front fork | 6-28 |
| ABS (for ABS models) | 3-8 | Canister (for California only) | 6-11 | Checking the steering | 6-29 |
| Fuel tank cap | 3-9 | Engine oil and oil filter cartridge ... | 6-11 | Checking the wheel bearings | 6-30 |
| Fuel | 3-10 | Final gear oil | 6-14 | Battery | 6-30 |
| Catalytic converter | 3-11 | Coolant | 6-15 | | |
| Seats | 3-11 | Cleaning the air filter element | 6-17 | | |
| Storage compartment | 3-12 | | | | |
| Accessory box | 3-12 | | | | |
| Adjusting the front fork | 3-13 | | | | |
| Adjusting the shock absorber assembly | 3-15 | | | | |

TABLE OF CONTENTS

| | |
|---|------|
| Replacing the fuses | 6-31 |
| Replacing a headlight bulb | 6-33 |
| Replacing a rear turn signal light bulb or a tail/brake light bulb | 6-34 |
| Troubleshooting | 6-35 |
| Troubleshooting charts | 6-36 |

MOTORCYCLE CARE AND

| | |
|----------------------|-----|
| STORAGE | 7-1 |
| Care | 7-1 |
| Storage | 7-3 |

| | |
|-----------------------------|-----|
| SPECIFICATIONS | 8-1 |
|-----------------------------|-----|

| | |
|-----------------------------------|-----|
| CONSUMER INFORMATION | 9-1 |
| Identification numbers | 9-1 |
| Reporting safety defects | 9-3 |
| Motorcycle noise regulation | 9-4 |
| Maintenance record | 9-5 |

| | |
|---|-----|
| YAMAHA MOTOR CORPORATION, U.S.A. STREET AND ENDURO MOTORCYCLE LIMITED WARRANTY | 9-7 |
| YAMAHA EXTENDED SERVICE (Y.E.S.) | 9-9 |

EAU10250

MOTORCYCLES ARE SINGLE TRACK VEHICLES. THEIR SAFE USE AND OPERATION ARE DEPENDENT UPON THE USE OF PROPER RIDING TECHNIQUES AS WELL AS THE EXPERTISE OF THE OPERATOR. EVERY OPERATOR SHOULD KNOW THE FOLLOWING REQUIREMENTS BEFORE RIDING THIS MOTORCYCLE.

HE OR SHE SHOULD:

- OBTAIN THOROUGH INSTRUCTIONS FROM A COMPETENT SOURCE ON ALL ASPECTS OF MOTORCYCLE OPERATION.
- OBSERVE THE WARNINGS AND MAINTENANCE REQUIREMENTS IN THE OWNER'S MANUAL.
- OBTAIN QUALIFIED TRAINING IN SAFE AND PROPER RIDING TECHNIQUES.
- OBTAIN PROFESSIONAL TECHNICAL SERVICE AS INDICATED BY THE OWNER'S MANUAL

AND/OR WHEN MADE NECESSARY BY MECHANICAL CONDITIONS.

Safe riding

- Always make pre-operation checks. Careful checks may help prevent an accident.
- This motorcycle is designed to carry the operator and a passenger.
- The failure of motorists to detect and recognize motorcycles in traffic is the predominating cause of automobile/motorcycle accidents. Many accidents have been caused by an automobile driver who did not see the motorcycle. Making yourself conspicuous appears to be very effective in reducing the chance of this type of accident.

Therefore:

- Wear a brightly colored jacket.
- Use extra caution when approaching and passing through intersections, since intersec-

tions are the most likely places for motorcycle accidents to occur.

- Ride where other motorists can see you. Avoid riding in another motorist's blind spot.
- Many motorcycle accidents involve inexperienced operators. In fact, many operators who have been involved in accidents do not even have a current motorcycle license.
 - Make sure that you are qualified and that you only lend your motorcycle to other qualified operators.
 - Know your skills and limits. Staying within your limits may help you to avoid an accident.
 - We recommend that you practice riding your motorcycle where there is no traffic until you have become thoroughly familiar with the motorcycle and all of its controls.
- Many motorcycle accidents have been caused by error of the motorcycle operator. A typical error made by the operator is veering

SAFETY INFORMATION

1

wide on a turn due to EXCESSIVE SPEED or undercornering (insufficient lean angle for the speed).

- Always obey the speed limit and never travel faster than warranted by road and traffic conditions.
- Always signal before turning or changing lanes. Make sure that other motorists can see you.
- The posture of the operator and passenger is important for proper control.
 - The operator should keep both hands on the handlebar and both feet on the operator footrests during operation to maintain control of the motorcycle.
 - The passenger should always hold onto the operator, seat strap, or grab bar, if equipped, with both hands and keep both feet on the passenger footrests.
 - Never carry a passenger unless he or she can firmly place both feet on the passenger footrests.
- Never ride under the influence of alcohol or other drugs.

- This motorcycle is designed for on-road use only, therefore, it is not suitable for off-road use.

Protective apparel

The majority of fatalities from motorcycle accidents are the result of head injuries. The use of a safety helmet is the single most critical factor in the prevention or reduction of head injuries.

- Always wear an approved helmet.
- Wear a face shield or goggles. Wind in your unprotected eyes could contribute to an impairment of vision which could delay seeing a hazard.
- The use of a jacket, heavy boots, trousers, gloves, etc., is effective in preventing or reducing abrasions or lacerations.
- Never wear loose-fitting clothes, otherwise they could catch on the control levers, footrests, or wheels and cause injury or an accident.
- Never touch the engine or exhaust system during or after operation. They become very hot and can

cause burns. Always wear protective clothing that covers your legs, ankles, and feet.

- Passengers should also observe the precautions mentioned above.

Modifications

Modifications made to this motorcycle not approved by Yamaha, or the removal of original equipment, may render the motorcycle unsafe for use and may cause severe personal injury. Modifications may also make your motorcycle illegal to use.

Loading and accessories

Adding accessories or cargo to your motorcycle can adversely affect stability and handling if the weight distribution of the motorcycle is changed. To avoid the possibility of an accident, use extreme caution when adding cargo or accessories to your motorcycle. Use extra care when riding a motorcycle that has added cargo or accessories. Here are some general guidelines to follow if loading cargo or adding accessories to your motorcycle:

Loading

The total weight of the operator, passenger, accessories and cargo must not exceed the maximum load limit of FJR1300 200 kg (441 lb) (CAL) FJR1300 201 kg (443 lb) (U49) FJR1300A 193 kg (425 lb) (CAL) FJR1300A 194 kg (428 lb) (U49). When loading within this weight limit, keep the following in mind:

- Cargo and accessory weight should be kept as low and close to the motorcycle as possible. Make sure to distribute the weight as evenly as possible on both sides of the motorcycle to minimize imbalance or instability.
- Shifting weights can create a sudden imbalance. Make sure that accessories and cargo are securely attached to the motorcycle before riding. Check accessory mounts and cargo restraints frequently.
- Never attach any large or heavy items to the handlebar, front fork, or front fender. These items, including such cargo as sleeping

bags, duffel bags, or tents, can create unstable handling or slow steering response.

Accessories

Genuine Yamaha accessories have been specifically designed for use on this motorcycle. Since Yamaha cannot test all other accessories that may be available, you must personally be responsible for the proper selection, installation and use of non-Yamaha accessories. Use extreme caution when selecting and installing any accessories.

Keep the following guidelines in mind, as well as those provided under “Loading” when mounting accessories.

- Never install accessories or carry cargo that would impair the performance of your motorcycle. Carefully inspect the accessory before using it to make sure that it does not in any way reduce ground clearance or cornering clearance,

limit suspension travel, steering travel or control operation, or obscure lights or reflectors.

- Accessories fitted to the handlebar or the front fork area can create instability due to improper weight distribution or aerodynamic changes. If accessories are added to the handlebar or front fork area, they must be as lightweight as possible and should be kept to a minimum.
- Bulky or large accessories may seriously affect the stability of the motorcycle due to aerodynamic effects. Wind may attempt to lift the motorcycle, or the motorcycle may become unstable in cross winds. These accessories may also cause instability when passing or being passed by large vehicles.
- Certain accessories can displace the operator from his or her normal riding position. This improper position limits the freedom of movement of the opera-

SAFETY INFORMATION

1

tor and may limit control ability, therefore, such accessories are not recommended.

- Use caution when adding electrical accessories. If electrical accessories exceed the capacity of the motorcycle's electrical system, an electric failure could result, which could cause a dangerous loss of lights or engine power.

Gasoline and exhaust gas

- GASOLINE IS HIGHLY FLAMMABLE:
 - Always turn the engine off when refueling.
 - Take care not to spill any gasoline on the engine or exhaust system when refueling.
 - Never refuel while smoking or in the vicinity of an open flame.
- Never start the engine or let it run for any length of time in a closed area. The exhaust fumes are poisonous and may cause loss of consciousness and death within a short time. Always operate your motorcycle in an area that has adequate ventilation.

- Always turn the engine off before leaving the motorcycle unattended and remove the key from the main switch. When parking the motorcycle, note the following:
 - The engine and exhaust system may be hot, therefore, park the motorcycle in a place where pedestrians or children are not likely to touch these hot areas.
 - Do not park the motorcycle on a slope or soft ground, otherwise it may fall over.
 - Do not park the motorcycle near a flammable source (e.g. a kerosene heater, or near an open flame), otherwise it could catch fire.
- When transporting the motorcycle in another vehicle, make sure that it is kept upright and that the fuel cock is turned to "ON" or "RES" (for vacuum type) / "OFF" (for manual type). If it should lean over, gasoline may leak out of the carburetor or fuel tank.
- If you should swallow any gasoline, inhale a lot of gasoline vapor, or allow gasoline to get into your

eyes, see your doctor immediately. If any gasoline spills on your skin or clothing, immediately wash the affected area with soap and water and change your clothes.

Location of important labels

Please read the following important labels carefully before operating this vehicle.

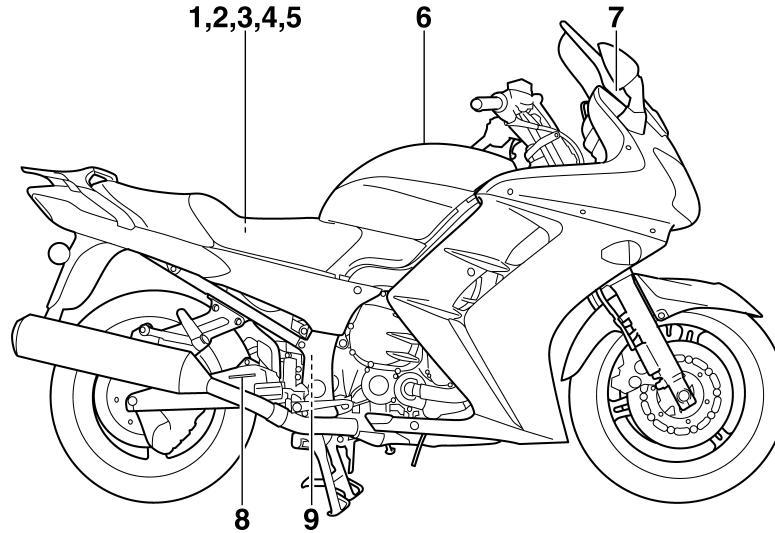

SAFETY INFORMATION

1

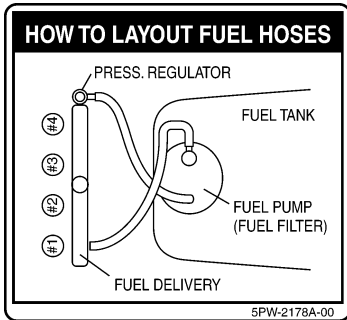

3

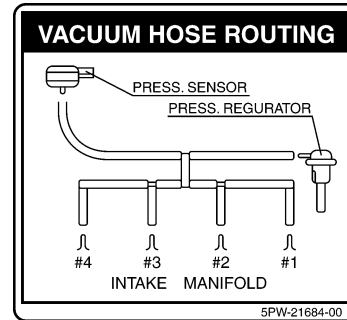

2 California only

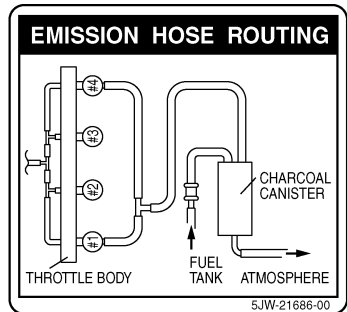

4

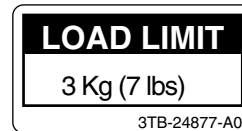

1

5

⚠ WARNING

Improper loading can cause loss of control.
Read owner's manual for proper loading.

3JJ-28446-A1

6

⚠ WARNING

- **BEFORE YOU OPERATE THIS VEHICLE, READ THE OWNER'S MANUAL AND ALL LABELS.**
- **ALWAYS WEAR AN APPROVED MOTORCYCLE HELMET, eye protection, and protective clothing.**

5GK-2118K-00

7

CAUTION

- Cleaning with alkaline or acid cleaner, gasoline or solvent will damage windshield.
- Use neutral detergent.

5JW-00

8

TIRE INFORMATION

Cold tire normal pressure should be set as follows.

- Up to 90 kg (198 lbs) load

FRONT : 250 kPa, {2.50 kgf/cm²}, 36psi
REAR : 250 kPa, {2.50 kgf/cm²}, 36psi

- 90 kg (198 lbs) ~ maximum load

FRONT : 250 kPa, {2.50 kgf/cm²}, 36psi
REAR : 290 kPa, {2.90 kgf/cm²}, 42psi

5JW-21668-00

9

⚠ WARNING

This unit contains high pressure nitrogen gas. Mishandling can cause explosion.

- Read owner's manual for instructions.
- Do not incinerate, puncture or open.

4AA-22259-00

DESCRIPTION

EAU10410

Left view

2

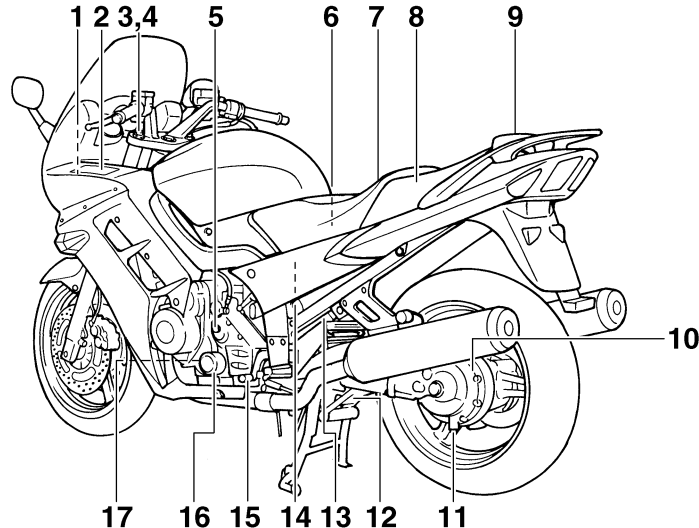

- | | |
|--|--|
| 1. Fuse box (page 6-31) | 12. Shock absorber assembly rebound damping force adjusting knob (page 3-15) |
| 2. Accessory box (page 3-12) | 13. Shock absorber assembly spring preload adjusting lever (page 3-15) |
| 3. Front fork spring preload adjusting bolt (page 3-13) | 14. Air filter element (page 6-17) |
| 4. Front fork rebound damping force adjusting knob (page 3-13) | 15. Shift pedal (page 3-7) |
| 5. Engine oil filler cap (page 6-11) | 16. Engine oil filter cartridge (page 6-11) |
| 6. Owner's tool kit (page 6-1) | 17. Engine oil level check window (page 6-11) |
| 7. Rider seat (page 3-11) | |
| 8. Passenger seat (page 3-11) | |
| 9. Carrier | |
| 10. Final gear oil filler bolt (page 6-14) | |
| 11. Final gear oil drain bolt (page 6-14) | |

Right view

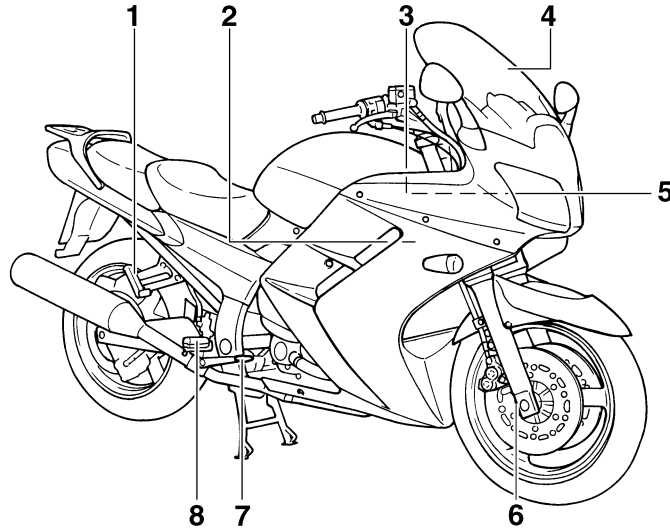

1. Passenger footrest
2. Coolant reservoir (page 6-15)
3. Battery (page 6-30)
4. Windshield
5. Main fuse and electronic fuel injection fuse (page 6-31)
6. Front fork compression damping force adjusting screw (page 3-13)
7. Brake pedal (page 3-8)
8. Rider footrest

DESCRIPTION

EAU10430

Controls and instruments

2

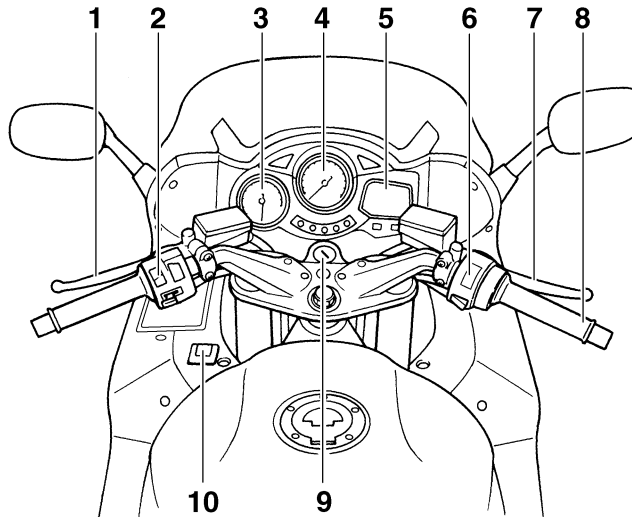

1. Clutch lever (page 3-7)
2. Left handlebar switch (page 3-5)
3. Tachometer (page 3-3)
4. Speedometer (page 3-3)
5. Multi-function display (page 3-4)
6. Right handlebar switches (page 3-5)
7. Brake lever (page 3-8)
8. Throttle grip (page 6-18)
9. Main switch/steering lock (page 3-1)
10. Hazard switch (page 3-6)

INSTRUMENT AND CONTROL FUNCTIONS

Main switch/steering lock

EAU10460

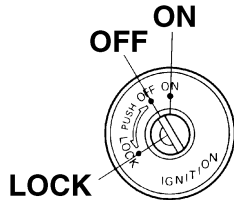

The main switch/steering lock controls the ignition and lighting systems, and is used to lock the steering. The various positions are described below.

ON

EAU35920

All electrical circuits are supplied with power, and the meter lighting, taillight and position lights come on, and the engine can be started. The key cannot be removed.

NOTE:

The headlights come on automatically when the engine is started and stay on until the key is turned to "OFF", even if the engine stalls.

OFF

All electrical systems are off. The key can be removed.

LOCK

The steering is locked, and all electrical systems are off. The key can be removed.

To lock the steering

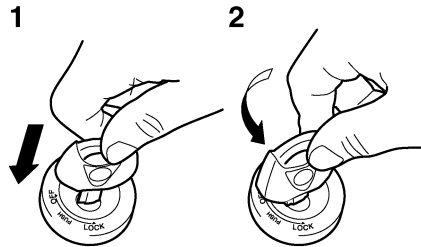

1. Push.
2. Turn.

1. Turn the handlebars all the way to the left or right.
2. Push the key in from the "OFF" position, and then turn it to "LOCK" while still pushing it.
3. Remove the key.

EAU10660

To unlock the steering

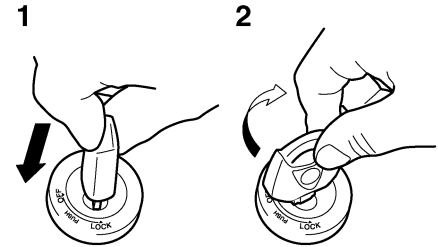

1. Push.
2. Turn.

Push the key into the main switch, and then turn it to "OFF" while still pushing it.

! WARNING

Never turn the key to "OFF" or "LOCK" while the vehicle is moving, otherwise the electrical systems will be switched off, which may result in loss of control or an accident. Make sure that the vehicle is stopped before turning the key to "OFF" or "LOCK".





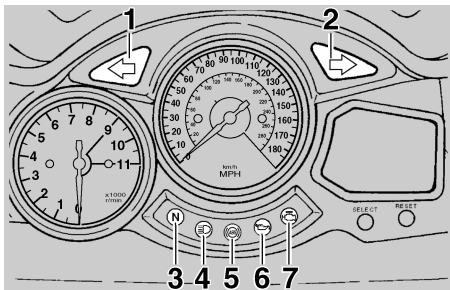

EWA10060

INSTRUMENT AND CONTROL FUNCTIONS

Indicator and warning lights

EAU11001



1. Left turn signal indicator light “”
2. Right turn signal indicator light “”
3. Neutral indicator light “**N**”
4. High beam indicator light “”
5. Anti-lock Brake System (ABS) warning light “” (for ABS models)
6. Oil level warning light “”
7. Engine trouble warning light “”

Turn signal indicator lights “” and “”

EAU11030

The corresponding indicator light flashes when the turn signal switch is pushed to the left or right.

Neutral indicator light “**N**”

EAU11060

This indicator light comes on when the transmission is in the neutral position.

High beam indicator light “”

EAU11080

This indicator light comes on when the high beam of the headlight is switched on.

Oil level warning light “”

EAU11120

This warning light comes on when the engine oil level is low.

The electrical circuit of the warning light can be checked by turning the key to “ON”.

If the warning light does not come on for a few seconds, then go off, have a Yamaha dealer check the electrical circuit.

NOTE: _____

Even if the oil level is sufficient, the warning light may flicker when riding on a slope or during sudden acceleration or deceleration, but this is not a malfunction.

Engine trouble warning light “”

EAU11530

This warning light comes on or flashes when an electrical circuit monitoring the engine is defective. When this occurs, have a Yamaha dealer check the self-diagnosis system. (See page 3-4 for an explanation of the self-diagnosis device.)

The electrical circuit of the warning light can be checked by turning the key to “ON”. If the warning light does not come on for a few seconds, then go off, have a Yamaha dealer check the electrical circuit.

ABS warning light “” (for ABS models)

EAU11543

If this warning light comes on or flashes while riding, the ABS may be defective. If this occurs, have a Yamaha dealer check the system as soon as possible. (See page 3-8.)

WARNING

EWA10081

If the ABS warning light comes on or flashes while riding, the brake system reverts to conventional braking. Therefore, be careful not to cause

INSTRUMENT AND CONTROL FUNCTIONS

the wheels to lock during emergency braking. If the warning light comes on or flashes while riding, have a Yamaha dealer check the brake system as soon as possible.

The electrical circuit of the warning light can be checked by turning the key to "ON".

If the warning light does not come on or remains on, have a Yamaha dealer check the electrical circuit.

Speedometer

EAU11601

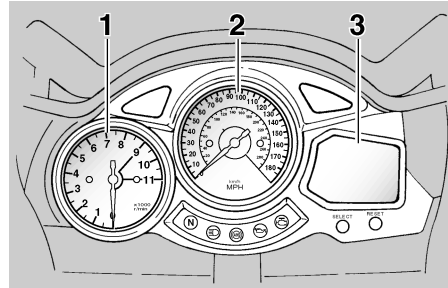

1. Tachometer
2. Speedometer
3. Multi-function display

The speedometer shows the riding speed.

When the key is turned to "ON", the speedometer needle will sweep once across the speed range and then return to zero in order to test the electrical circuit.

Tachometer

EAU11872

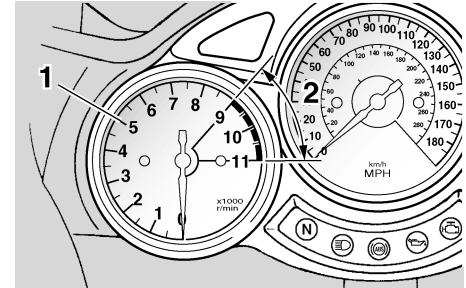

1. Tachometer
2. Tachometer red zone

The electric tachometer allows the rider to monitor the engine speed and keep it within the ideal power range.

When the key is turned to "ON", the tachometer needle will sweep once across the r/min range and then return to zero r/min in order to test the electrical circuit.

CAUTION:

Do not operate the engine in the tachometer red zone.

Red zone: 9000 r/min and above

ECA10031

3

INSTRUMENT AND CONTROL FUNCTIONS

EAU12250

Multi-function display

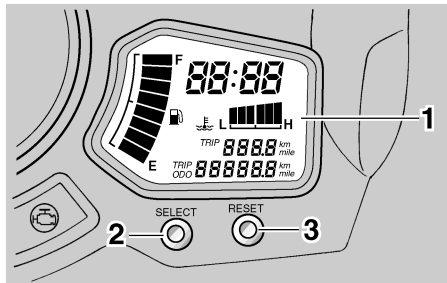

1. Multi-function display
2. "SELECT" button
3. "RESET" button

The multi-function display is equipped with the following:

- a fuel gauge
- a coolant temperature gauge
- an odometer (which shows the total distance traveled)
- two tripmeters (which show the distance traveled since they were last set to zero)
- a fuel reserve tripmeter (which shows the distance traveled on the fuel reserve)
- a self-diagnosis device
- a clock

NOTE:

- Be sure to turn the key to "ON" before using the "SELECT" and "RESET" buttons.
- To switch the speedometer display between kilometers and miles, press the "SELECT" button for at least two seconds.

Odometer and tripmeter modes

Pushing the "SELECT" button switches the display between the odometer mode "ODO" and the tripmeter modes "TRIP" in the following order:

ODO → TRIP (top) → TRIP (bottom) → ODO

When approximately 5.0 L (1.32 US gal) (1.10 Imp.gal) of fuel remains in the fuel tank, the display will automatically change to the fuel reserve tripmeter mode "TRIP F" and start counting the distance traveled from that point. In that case, pushing the "SELECT" button switches the display between the various tripmeter and odometer modes in the following order:

TRIP F → TRIP (top) → TRIP (bottom) → ODO → TRIP F

To reset a tripmeter, select it by pushing the "SELECT" button, and then push the "RESET" button for at least one second. If you do not reset the fuel reserve tripmeter manually, it will reset itself automatically and the display will return to the prior mode after refueling and traveling 5 km (3 mi).

Self-diagnosis device

This model is equipped with a self-diagnosis device for various electrical circuits.

If any of those circuits are defective, the clock will indicate a two-digit error code (e.g., 11, 12, 13).

If the clock indicates such an error code, note the code number, and then have a Yamaha dealer check the vehicle.

ECA11360

CAUTION:

If the clock indicates an error code, the vehicle should be checked as soon as possible in order to avoid engine damage.

INSTRUMENT AND CONTROL FUNCTIONS

Clock mode

To set the clock:

1. Push the "SELECT" button and "RESET" button together for at least two seconds.
2. When the hour digits start flashing, push the "RESET" button to set the hours.
3. Push the "SELECT" button, and the minute digits will start flashing.
4. Push the "RESET" button to set the minutes.
5. Push the "SELECT" button and then release it to start the clock.

Handlebar switches

EAU12343

Left

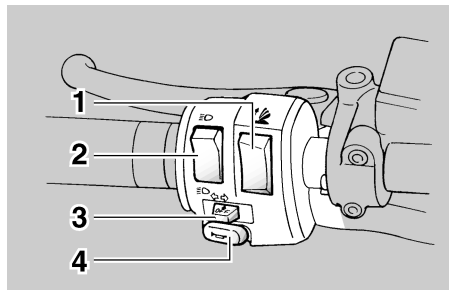

1. Windshield position adjusting switch "↕"
2. Dimmer switch "☰/☷"
3. Turn signal switch "↶/↷"
4. Horn switch "🔊"

Right

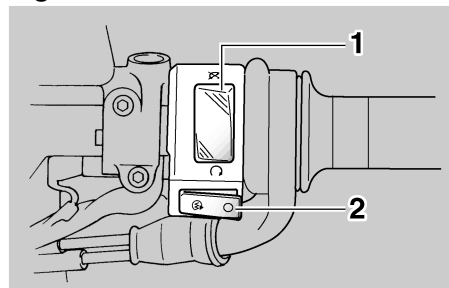

1. Engine stop switch "⊙/⊗"
2. Start switch "🌀"

Dimmer switch "☰/☷"

EAU12400

Set this switch to "☰" for the high beam and to "☷" for the low beam.

Turn signal switch "↶/↷"

EAU12460

To signal a right-hand turn, push this switch to "↷". To signal a left-hand turn, push this switch to "↶". When released, the switch returns to the center position. To cancel the turn signal lights, push the switch in after it has returned to the center position.

Windshield position adjusting switch "↕"

EAU12492

To move the windshield up, push this switch in direction (a). To move the windshield down, push the switch in direction (b).

INSTRUMENT AND CONTROL FUNCTIONS

3

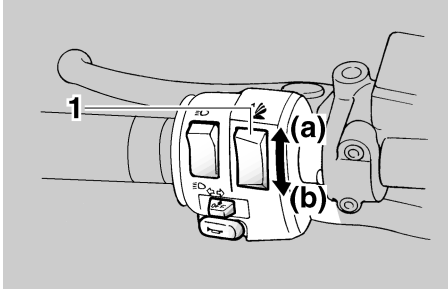

1. Windshield position adjusting switch “↕”

NOTE:

When the engine is turned off, the windshield will automatically return to the lowest position.

Horn switch “📢”

Press this switch to sound the horn.

EAU12500

Engine stop switch “⊙/⊗”

Set this switch to “⊙” before starting the engine. Set this switch to “⊗” to stop the engine in case of an emergency, such as when the vehicle overturns or when the throttle cable is stuck.

EAU12660

Start switch “🔌”

Push this switch to crank the engine with the starter.

EAU12710

ECA10050

CAUTION:

See page 5-1 for starting instructions prior to starting the engine.

ECA10060

CAUTION:

Do not use the hazard light for an extended length of time, otherwise the battery may discharge.

EAU12763

Hazard switch “⚠️”

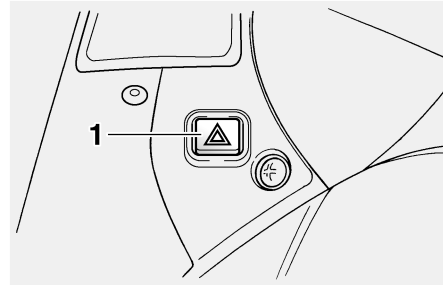

1. Hazard switch “⚠️”

With the key in the “ON” position, turn this switch to “⚠️” to turn on the hazard lights (simultaneous flashing of all turn signal lights).

EAU12830

Clutch lever

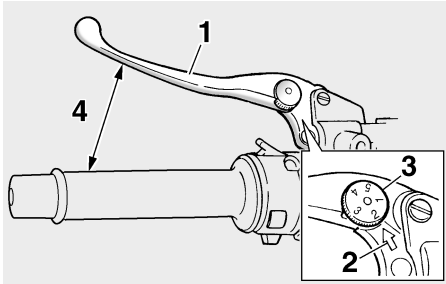

1. Clutch lever
2. Arrow mark
3. Clutch lever position adjusting dial
4. Distance between clutch lever and handlebar grip

The clutch lever is located at the left handlebar grip. To disengage the clutch, pull the lever toward the handlebar grip. To engage the clutch, release the lever. The lever should be pulled rapidly and released slowly for smooth clutch operation.

The clutch lever is equipped with a clutch lever position adjusting dial. To adjust the distance between the clutch lever and the handlebar grip, turn the adjusting dial while holding the lever pushed away from the handlebar grip.

Make sure that the appropriate setting on the adjusting dial is aligned with the arrow mark on the clutch lever. The clutch lever is equipped with a clutch switch, which is part of the ignition circuit cut-off system. (See page 3-17.)

EAU12870

Shift pedal

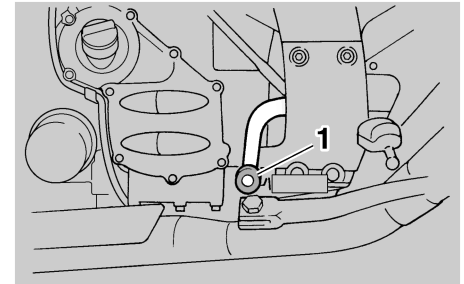

1. Shift pedal

The shift pedal is located on the left side of the engine and is used in combination with the clutch lever when shifting the gears of the 5-speed constant-mesh transmission equipped on this motorcycle.

INSTRUMENT AND CONTROL FUNCTIONS

EAU12930

Brake lever

The brake lever is located at the right handlebar grip. To apply the front brake, pull the lever toward the handlebar grip.

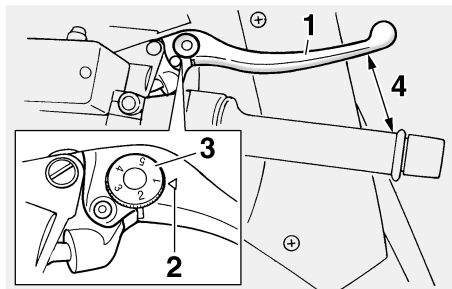

1. Brake lever
2. Arrow mark
3. Brake lever position adjusting dial
4. Distance between brake lever and handlebar grip

The brake lever is equipped with a position adjusting dial. To adjust the distance between the brake lever and the handlebar grip, turn the adjusting dial while holding the lever pushed away from the handlebar grip. Make sure that the appropriate setting on the adjusting dial is aligned with the arrow mark on the brake lever.

EAU12941

Brake pedal

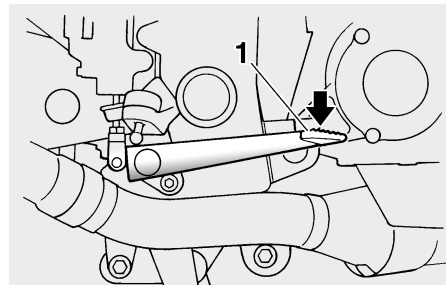

1. Brake pedal

The brake pedal is on the right side of the motorcycle. To apply the rear brake, press down on the brake pedal.

EAU26792

ABS (for ABS models)

The Yamaha ABS (Anti-lock Brake System) features a dual electronic control system, which acts on the front and rear brakes independently. The ABS is monitored by an ECU (Electronic Control Unit), which will have recourse to manual braking if a malfunction occurs.

EWA10090

⚠ WARNING

- The ABS performs best on long braking distances.
- On certain (rough or gravel) roads, the braking distance may be longer with than without the ABS. Therefore, always keep a sufficient distance to the vehicle ahead to match the riding speed.

NOTE:

- When the ABS is activated, the brakes are operated in the usual way. A pulsating action may be felt at the brake lever or brake pedal, but this does not indicate a malfunction.

INSTRUMENT AND CONTROL FUNCTIONS

- This ABS has a test mode which allows the owner to experience the pulsating at the brake lever or brake pedal when the ABS is operating. However, special tools are required, so please consult your Yamaha dealer when performing this test.

Fuel tank cap

EAU13070

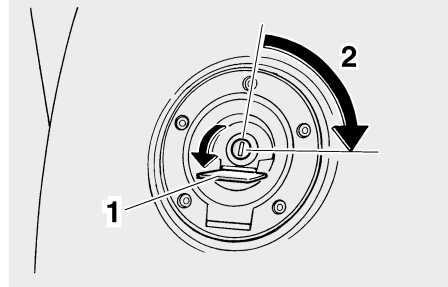

1. Fuel tank cap lock cover
2. Unlock.

To open the fuel tank cap

Open the fuel tank cap lock cover, insert the key into the lock, and then turn it 1/4 turn clockwise. The lock will be released and the fuel tank cap can be opened.

To close the fuel tank cap

1. Push the fuel tank cap into position with the key inserted in the lock.
2. Turn the key counterclockwise to the original position, remove it, and then close the lock cover.

NOTE: _____

The fuel tank cap cannot be closed unless the key is in the lock. In addition, the key cannot be removed if the cap is not properly closed and locked.

EWA11090



WARNING _____

Make sure that the fuel tank cap is properly closed before riding.

3

INSTRUMENT AND CONTROL FUNCTIONS

Fuel

EAU13210

ECA10070

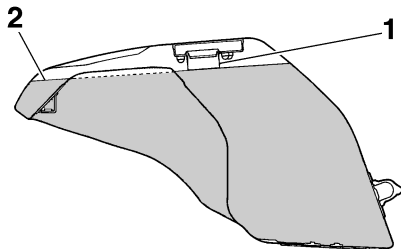

1. Fuel tank filler tube
2. Fuel level

Make sure that there is sufficient fuel in the tank. Fill the fuel tank to the bottom of the filler tube as shown.

EWA10880

ECA11400

⚠ WARNING

- Do not overfill the fuel tank, otherwise it may overflow when the fuel warms up and expands.
- Avoid spilling fuel on the hot engine.

CAUTION:

Immediately wipe off spilled fuel with a clean, dry, soft cloth, since fuel may deteriorate painted surfaces or plastic parts.

EAU13360

Recommended fuel

UNLEADED GASOLINE ONLY

Fuel tank capacity:

25.0 L (6.61 US gal) (5.50 Imp.gal)

Fuel reserve amount (when the fuel level warning light comes on):

5.0 L (1.32 US gal) (1.10 Imp.gal)

CAUTION:

Use only unleaded gasoline. The use of leaded gasoline will cause severe damage to internal engine parts, such as the valves and piston rings, as well as to the exhaust system.

Your Yamaha engine has been designed to use regular unleaded gasoline with a pump octane number $[(R+M)/2]$ of 86 or higher, or a research octane number of 91 or higher. If

knocking (or pinging) occurs, use a gasoline of a different brand or premium unleaded fuel. Use of unleaded fuel will extend spark plug life and reduce maintenance costs.

Gasohol

There are two types of gasohol: gasohol containing ethanol and that containing methanol. Gasohol containing ethanol can be used if the ethanol content does not exceed 10%. Gasohol containing methanol is not recommended by Yamaha because it can cause damage to the fuel system or vehicle performance problems.

INSTRUMENT AND CONTROL FUNCTIONS

Catalytic converter

EAU13430

This model is equipped with a catalytic converter in the exhaust chamber.

EWA10860

WARNING

The exhaust system is hot after operation. Make sure that the exhaust system has cooled down before doing any maintenance work.

ECA10700

CAUTION:

The following precautions must be observed to prevent a fire hazard or other damages.

- Use only unleaded gasoline. The use of leaded gasoline will cause unreparable damage to the catalytic converter.
- Never park the vehicle near possible fire hazards such as grass or other materials that easily burn.
- Do not allow the engine to idle too long.

Seats

EAU14080

Rider seat

To remove the rider seat

1. Insert the key into the seat lock, and then turn it as shown.

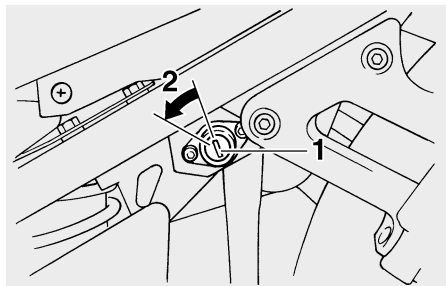

1. Rider seat lock
2. Unlock.

2. Pull the rider seat off.

To install the rider seat

1. Insert the projection on the front of the rider seat into the seat holder as shown, and then push the rear of the seat down to lock it in place.

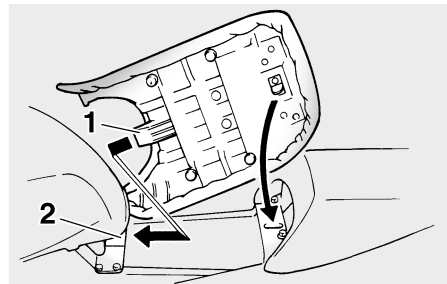

1. Projection
2. Seat holder

2. Remove the key.

Passenger seat

To remove the passenger seat

1. Remove the rider seat.
2. Pull the passenger seat up.

To install the passenger seat

1. Slide the receptacle on the rear of the passenger seat over the seat holder as shown, and then push the front of the seat down.

INSTRUMENT AND CONTROL FUNCTIONS

3

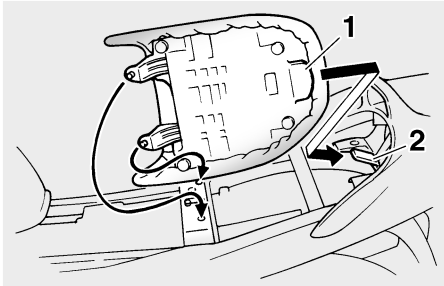

1. Receptacle
2. Seat holder

2. Install the rider seat.

NOTE: _____
Make sure that the seats are properly secured before riding.

Storage compartment

EAU14461

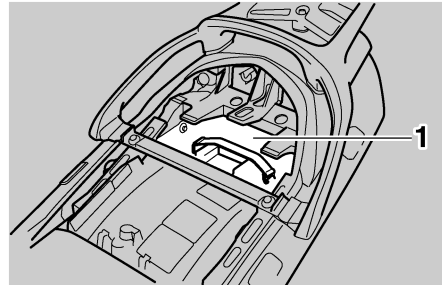

1. Storage compartment

The storage compartment is located under the passenger seat. (See page 3-11.)

! WARNING

EWA10961

- Do not exceed the load limit of 3 kg (7 lb) for the storage compartment.
- Do not exceed the maximum load of FJR1300 200 kg (441 lb) (CAL)
FJR1300 201 kg (443 lb) (U49)
FJR1300A 193 kg (425 lb) (CAL)
FJR1300A 194 kg (428 lb) (U49)
for the vehicle.

Accessory box

EAU26882

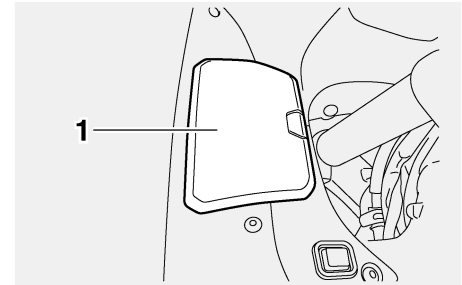

1. Accessory box

The accessory box is located beside the meter panel.

NOTE: _____
The accessory box can only be opened when the key is turned to "ON" and the transmission is in neutral.

ECA11800

CAUTION: _____
Do not place heat-sensitive items in the accessory box. The accessory box gets extremely hot especially when the engine is running or is hot.

INSTRUMENT AND CONTROL FUNCTIONS

EWA11421

WARNING

- Do not exceed the load limit of 0.3 kg (0.66 lb) for the accessory box.
- Do not exceed the maximum load of FJR1300 200 kg (441 lb) (CAL)
FJR1300 201 kg (443 lb) (U49)
FJR1300A 193 kg (425 lb) (CAL)
FJR1300A 194 kg (428 lb) (U49)
for the vehicle.

EWA10180

Adjusting the front fork

This front fork is equipped with spring preload adjusting bolts, rebound damping force adjusting knobs and compression damping force adjusting screws.

WARNING

Always adjust both fork legs equally, otherwise poor handling and loss of stability may result.

Spring preload

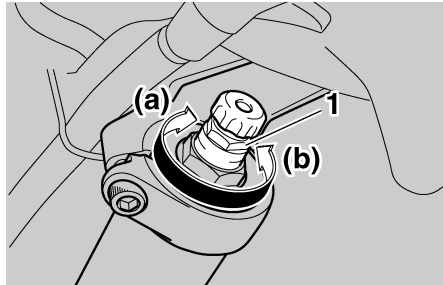

1. Spring preload adjusting bolt

To increase the spring preload and thereby harden the suspension, turn the adjusting bolt on each fork leg in direction (a). To decrease the spring pre-

EAU14731

load and thereby soften the suspension, turn the adjusting bolt on each fork leg in direction (b).

NOTE:

Align the appropriate groove on the adjusting mechanism with the top of the front fork cap bolt.

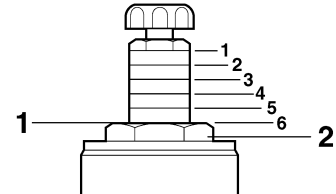

1. Current setting
2. Front fork cap bolt

Spring preload setting:

Minimum (soft):

6

Standard:

4

Maximum (hard):

1

INSTRUMENT AND CONTROL FUNCTIONS

ECA10100

Rebound damping force

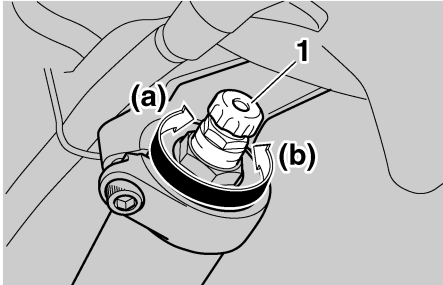

1. Rebound damping force adjusting knob

To increase the rebound damping force and thereby harden the rebound damping, turn the adjusting knob on each fork leg in direction (a). To decrease the rebound damping force and thereby soften the rebound damping, turn the adjusting knob on each fork leg in direction (b).

Rebound damping setting:

Minimum (soft):

17 click(s) in direction (b)*

Standard:

12 click(s) in direction (b)*

Maximum (hard):

1 click(s) in direction (b)*

* With the adjusting knob fully turned in direction (a)

Compression damping force

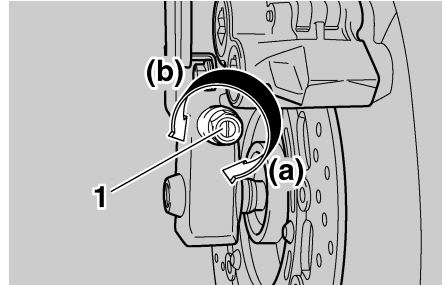

1. Compression damping force adjusting screw

To increase the compression damping force and thereby harden the compression damping, turn the adjusting screw on each fork leg in direction (a). To decrease the compression damping force and thereby soften the compression damping, turn the adjusting screw on each fork leg in direction (b).

Compression damping setting:

Minimum (soft):

21 click(s) in direction (b)*

Standard:

12 click(s) in direction (b)*

Maximum (hard):

1 click(s) in direction (b)*

* With the adjusting screw fully turned in direction (a)

CAUTION:

Never attempt to turn an adjusting mechanism beyond the maximum or minimum settings.

NOTE:

Although the total number of clicks of a damping force adjusting mechanism may not exactly match the above specifications due to small differences in production, the actual number of clicks always represents the entire adjusting range. To obtain a precise adjustment, it would be advisable to check the number of clicks of each damping force adjusting mechanism and to modify the specifications as necessary.

Adjusting the shock absorber assembly

EAU14911

This shock absorber assembly is equipped with a spring preload adjusting lever and a rebound damping force adjusting knob.

ECA10100

CAUTION:

Never attempt to turn an adjusting mechanism beyond the maximum or minimum settings.

Spring preload

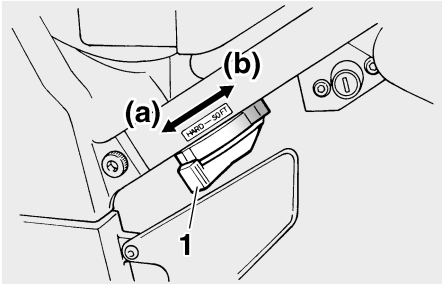

1. Spring preload adjusting lever

For riding solo, move the spring preload adjusting lever in direction (b). For riding with a passenger, move the spring preload adjusting lever in direction (a).

Rebound damping force

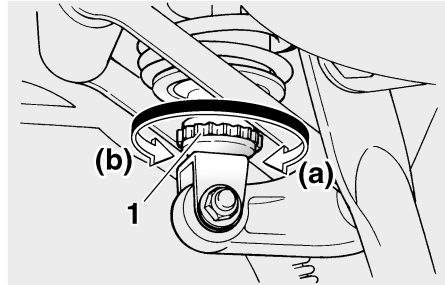

1. Rebound damping force adjusting knob

To increase the rebound damping force and thereby harden the rebound damping, turn the adjusting knob in direction (a). To decrease the rebound damping force and thereby soften the rebound damping, turn the adjusting knob in direction (b).

Rebound damping setting:

Minimum (soft):

20 click(s) in direction (b)*

Standard:

10 click(s) in direction (b)*

Maximum (hard):

3 click(s) in direction (b)*

* With the adjusting knob fully turned in direction (a)

EWA10220

WARNING

This shock absorber contains highly pressurized nitrogen gas. For proper handling, read and understand the following information before handling the shock absorber. The manufacturer cannot be held responsible for property damage or personal injury that may result from improper handling.

- Do not tamper with or attempt to open the gas cylinder.
- Do not subject the shock absorber to an open flame or other high heat sources, otherwise it may explode due to excessive gas pressure.

INSTRUMENT AND CONTROL FUNCTIONS

- Do not deform or damage the gas cylinder in any way, as this will result in poor damping performance.
- Always have a Yamaha dealer service the shock absorber.

Locks for the optional side cases and travel trunk

EAU15290

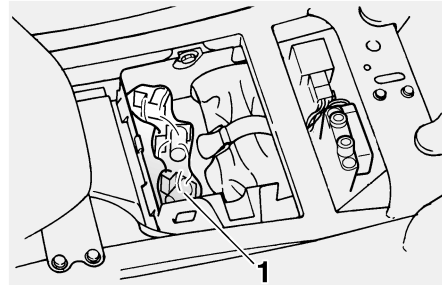

1. Plastic bag containing locks

There are three locks in a plastic bag located beside the owner's tool kit. When used to replace the locks of the optional side cases and travel trunk, which can be obtained at a Yamaha dealer, these locks can be operated with the ignition key. Keep these locks in a safe place to prevent losing them.

Sidestand

EAU15300

The sidestand is located on the left side of the frame. Raise the sidestand or lower it with your foot while holding the vehicle upright.

NOTE:

The built-in sidestand switch is part of the ignition circuit cut-off system, which cuts the ignition in certain situations. (See further down for an explanation of the ignition circuit cut-off system.)

EWA10240

⚠ WARNING

The vehicle must not be ridden with the sidestand down, or if the sidestand cannot be properly moved up (or does not stay up), otherwise the sidestand could contact the ground and distract the operator, resulting in a possible loss of control. Yamaha's ignition circuit cut-off system has been designed to assist the operator in fulfilling the responsibility of raising the sidestand before starting off. Therefore, check this system regularly as described

below and have a Yamaha dealer repair it if it does not function properly.

EAU15321

Ignition circuit cut-off system

The ignition circuit cut-off system (comprising the sidestand switch, clutch switch and neutral switch) has the following functions.

- It prevents starting when the transmission is in gear and the sidestand is up, but the clutch lever is not pulled.
- It prevents starting when the transmission is in gear and the clutch lever is pulled, but the sidestand is still down.
- It cuts the running engine when the transmission is in gear and the sidestand is moved down.

Periodically check the operation of the ignition circuit cut-off system according to the following procedure.

EWA10260

WARNING

- **The vehicle must be placed on the centerstand during this inspection.**
 - **If a malfunction is noted, have a Yamaha dealer check the system before riding.**
-

INSTRUMENT AND CONTROL FUNCTIONS

3

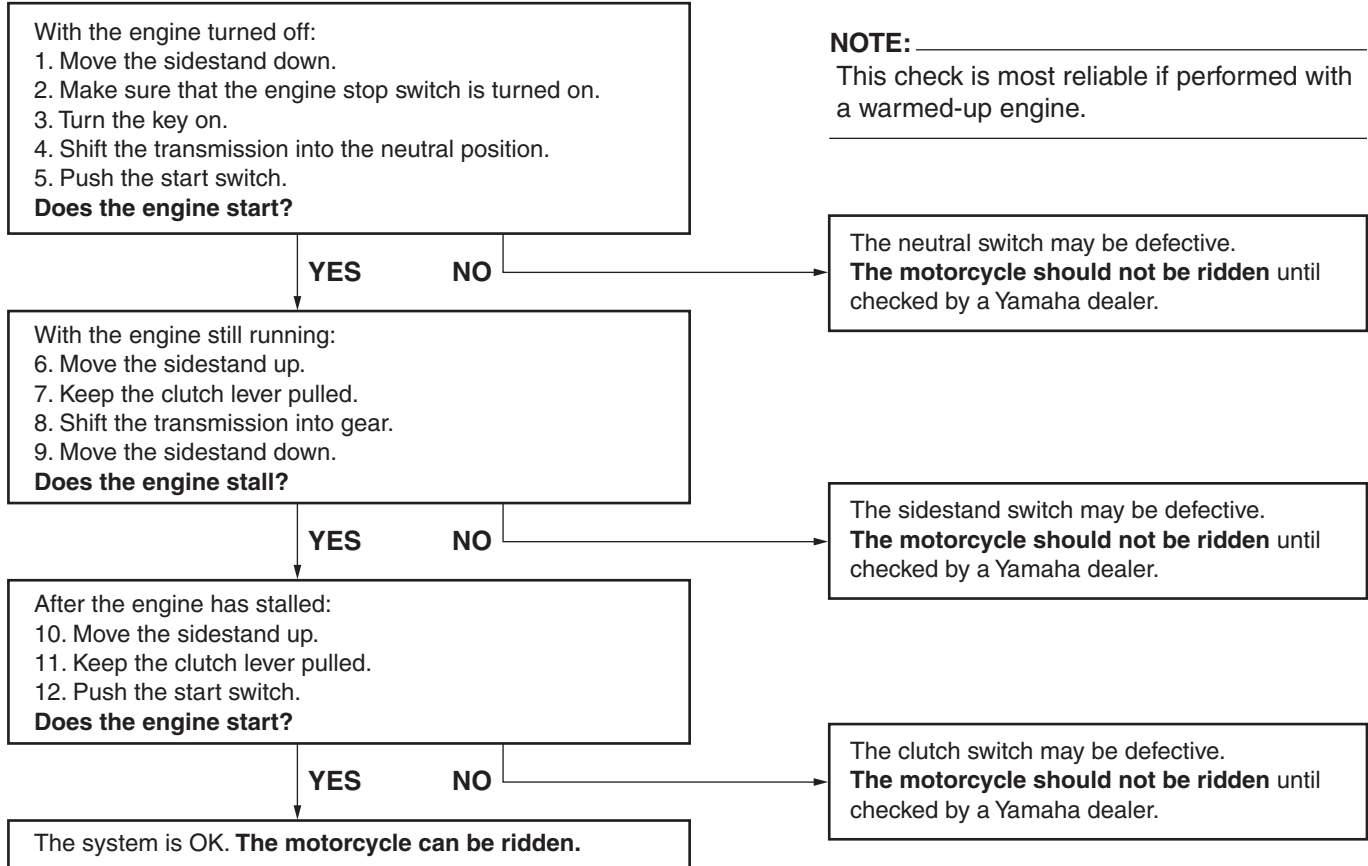

PRE-OPERATION CHECKS

EAU15591

The condition of a vehicle is the owner's responsibility. Vital components can start to deteriorate quickly and unexpectedly, even if the vehicle remains unused (for example, as a result of exposure to the elements). Any damage, fluid leakage or loss of tire air pressure could have serious consequences. Therefore, it is very important, in addition to a thorough visual inspection, to check the following points before each ride.

NOTE:

Pre-operation checks should be made each time the vehicle is used. Such an inspection can be accomplished in a very short time; and the added safety it assures is more than worth the time involved.

EWA11150



WARNING

If any item in the Pre-operation check list is not working properly, have it inspected and repaired before operating the vehicle.

PRE-OPERATION CHECKS

EAU15602

Pre-operation check list

| ITEM | CHECKS | PAGE |
|-----------------------|---|------------|
| Fuel | <ul style="list-style-type: none">• Check fuel level in fuel tank.• Refuel if necessary.• Check fuel line for leakage. | 3-10 |
| Engine oil | <ul style="list-style-type: none">• Check oil level in engine.• If necessary, add recommended oil to specified level.• Check vehicle for oil leakage. | 6-11 |
| Final gear oil | <ul style="list-style-type: none">• Check vehicle for oil leakage. | 6-14 |
| Coolant | <ul style="list-style-type: none">• Check coolant level in reservoir.• If necessary, add recommended coolant to specified level.• Check cooling system for leakage. | 6-15 |
| Front brake | <ul style="list-style-type: none">• Check operation.• If soft or spongy, have Yamaha dealer bleed hydraulic system.• Check brake pads for wear.• Replace if necessary.• Check fluid level in reservoir.• If necessary, add recommended brake fluid to specified level.• Check hydraulic system for leakage. | 6-23, 6-24 |
| Rear brake | <ul style="list-style-type: none">• Check operation.• If soft or spongy, have Yamaha dealer bleed hydraulic system.• Check brake pads for wear.• Replace if necessary.• Check fluid level in reservoir.• If necessary, add recommended brake fluid to specified level.• Check hydraulic system for leakage. | 6-23, 6-24 |
| Clutch | <ul style="list-style-type: none">• Check operation.• If soft or spongy, have Yamaha dealer bleed hydraulic system.• Check fluid level in reservoir.• If necessary, add recommended fluid to specified level.• Check hydraulic system for leakage. | 6-23, 6-24 |

4

PRE-OPERATION CHECKS

| ITEM | CHECKS | PAGE |
|--|--|------------|
| Throttle grip | <ul style="list-style-type: none"> • Make sure that operation is smooth. • Check cable free play. • If necessary, have Yamaha dealer adjust cable free play and lubricate cable and grip housing. | 6-18, 6-26 |
| Control cables | <ul style="list-style-type: none"> • Make sure that operation is smooth. • Lubricate if necessary. | 6-26 |
| Wheels and tires | <ul style="list-style-type: none"> • Check for damage. • Check tire condition and tread depth. • Check air pressure. • Correct if necessary. | 6-19, 6-22 |
| Brake and shift pedals | <ul style="list-style-type: none"> • Make sure that operation is smooth. • Lubricate pedal pivoting points if necessary. | 6-26 |
| Brake and clutch levers | <ul style="list-style-type: none"> • Make sure that operation is smooth. • Lubricate lever pivoting points if necessary. | 6-27 |
| Centerstand, sidestand | <ul style="list-style-type: none"> • Make sure that operation is smooth. • Lubricate pivots if necessary. | 6-28 |
| Chassis fasteners | <ul style="list-style-type: none"> • Make sure that all nuts, bolts and screws are properly tightened. • Tighten if necessary. | — |
| Instruments, lights, signals and switches | <ul style="list-style-type: none"> • Check operation. • Correct if necessary. | — |
| Sidestand switch | <ul style="list-style-type: none"> • Check operation of ignition circuit cut-off system. • If system is defective, have Yamaha dealer check vehicle. | 3-16 |

OPERATION AND IMPORTANT RIDING POINTS

EAU15950

EAU31950

EWA10270

WARNING

- **Become thoroughly familiar with all operating controls and their functions before riding. Consult a Yamaha dealer regarding any control or function that you do not thoroughly understand.**
- **Never start the engine or operate it in a closed area for any length of time. Exhaust fumes are poisonous, and inhaling them can cause loss of consciousness and death within a short time. Always make sure that there is adequate ventilation.**
- **Before starting out, make sure that the sidestand is up. If the sidestand is not raised completely, it could contact the ground and distract the operator, resulting in a possible loss of control.**

Starting the engine

In order for the ignition circuit cut-off system to enable starting, one of the following conditions must be met:

- The transmission is in the neutral position.
- The transmission is in gear with the clutch lever pulled and the sidestand up.

EWA10290

WARNING

- **Before starting the engine, check the function of the ignition circuit cut-off system according to the procedure described on page 3-17.**
- **Never ride with the sidestand down.**

1. Turn the key to "ON" and make sure that the engine stop switch is set to "○".

ECA12700

CAUTION:

The oil level warning light, engine trouble warning light and ABS warning light (for ABS models) should come on for a few seconds, then go

off. If a warning light does not go off, see page 3-2 for the corresponding warning light circuit check.

2. Shift the transmission into the neutral position.

NOTE:

When the transmission is in the neutral position, the neutral indicator light should be on, otherwise have a Yamaha dealer check the electrical circuit.

3. Start the engine by pushing the start switch.

NOTE:

If the engine fails to start, release the start switch, wait a few seconds, and then try again. Each starting attempt should be as short as possible to preserve the battery. Do not crank the engine more than 10 seconds on any one attempt.

OPERATION AND IMPORTANT RIDING POINTS

ECA11130

CAUTION:

For maximum engine life, always warm the engine up before starting off. Never accelerate hard when the engine is cold!

NOTE:

The engine is warm when it quickly responds to the throttle.

EAU16671

Shifting

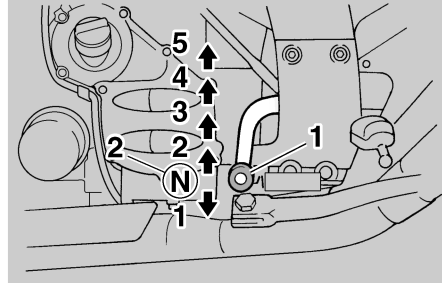

1. Shift pedal
2. Neutral position

Shifting gears lets you control the amount of engine power available for starting off, accelerating, climbing hills, etc.

The gear positions are shown in the illustration.

NOTE:

To shift the transmission into the neutral position, press the shift pedal down repeatedly until it reaches the end of its travel, and then slightly raise it.

ECA10260

CAUTION:

- Even with the transmission in the neutral position, do not coast for long periods of time with the engine off, and do not tow the motorcycle for long distances. The transmission is properly lubricated only when the engine is running. Inadequate lubrication may damage the transmission.
- Always use the clutch while changing gears to avoid damaging the engine, transmission, and drive train, which are not designed to withstand the shock of forced shifting.

5

EAU16680

To start out and accelerate

1. Pull the clutch lever to disengage the clutch.
2. Shift the transmission into first gear. The neutral indicator light should go out.
3. Open the throttle gradually, and at the same time, release the clutch lever slowly.

OPERATION AND IMPORTANT RIDING POINTS

4. At the recommended shift points shown in the following table, close the throttle, and at the same time, quickly pull the clutch lever in.
 5. Shift the transmission into second gear. (Make sure not to shift the transmission into the neutral position.)
 6. Open the throttle part way and gradually release the clutch lever.
 7. Follow the same procedure when shifting to the next higher gear.
3. Shift the transmission into the neutral position when the motorcycle is almost completely stopped. The neutral indicator light should come on.

Recommended shift points

The recommended shift points during acceleration and deceleration are shown in the table below.

Shift up points:

- 1st → 2nd: 20 km/h (12.5 mi/h)
- 2nd → 3rd: 30 km/h (19 mi/h)
- 3rd → 4th: 40 km/h (25 mi/h)
- 4th → 5th: 50 km/h (31 mi/h)

Shift down points:

- 5th → 4th: 25 km/h (15.5 mi/h)
- 4th → 3rd: 25 km/h (15.5 mi/h)
- 3rd → 2nd: 25 km/h (15.5 mi/h)
- 2nd → 1st: 25 km/h (15.5 mi/h)

Engine break-in

There is never a more important period in the life of your engine than the period between 0 and 1600 km (1000 mi). For this reason, you should read the following material carefully.

Since the engine is brand new, do not put an excessive load on it for the first 1600 km (1000 mi). The various parts in the engine wear and polish themselves to the correct operating clearances. During this period, prolonged full-throttle operation or any condition that might result in engine overheating must be avoided.

0–1000 km (0–600 mi)

Avoid prolonged operation above 5000 r/min.

1000–1600 km (600–1000 mi)

Avoid prolonged operation above 6000 r/min.

5 NOTE: Always shift gears at the recommended shift points.

To decelerate

1. Apply both the front and the rear brakes to slow the motorcycle.
2. Shift the transmission into first gear when the motorcycle reaches 25 km/h (15.5 mi/h). If the engine is about to stall or runs very roughly, pull the clutch lever in and use the brakes to stop the motorcycle.

OPERATION AND IMPORTANT RIDING POINTS

ECA10331

CAUTION:

After 1000 km (600 mi) of operation, the engine oil and final gear oil must be changed, and the oil filter cartridge or element replaced.

1600 km (1000 mi) and beyond

The vehicle can now be operated normally.

ECA10310

CAUTION:

- Keep the engine speed out of the tachometer red zone.
- If any engine trouble should occur during the engine break-in period, immediately have a Yamaha dealer check the vehicle.

EAU17211

Parking

When parking, stop the engine, and then remove the key from the main switch.

EWA10310

WARNING

- Since the engine and exhaust system can become very hot, park in a place where pedestrians or children are not likely to touch them.
- Do not park on a slope or on soft ground, otherwise the vehicle may overturn.

ECA10380

CAUTION:

Never park in an area where there are fire hazards such as grass or other flammable materials.

PERIODIC MAINTENANCE AND MINOR REPAIR

EAU17231

EAU17301

EAU17350

Safety is an obligation of the owner. Periodic inspection, adjustment and lubrication will keep your vehicle in the safest and most efficient condition possible. The most important points of motorcycle inspection, adjustment, and lubrication are explained on the following pages.

Maintenance, replacement, or repair of the emission control devices and systems may be performed by any repair establishment or individual that is certified (if applicable).

EWA10320

WARNING

If you are not familiar with maintenance work, have a Yamaha dealer do it for you.

PERIODIC MAINTENANCE

PROPER PERIODIC MAINTENANCE OF YOUR VEHICLE IS IMPORTANT IN ORDER TO ENJOY LONG, PLEASURABLE SERVICE. ESPECIALLY IMPORTANT ARE THE MAINTENANCE SERVICES RELATED TO EMISSIONS CONTROL. THESE CONTROLS NOT ONLY FUNCTION TO ENSURE CLEANER AIR, BUT ARE ALSO VITAL TO PROPER ENGINE OPERATION AND MAXIMUM PERFORMANCE. IN THE FOLLOWING PERIODIC MAINTENANCE CHARTS, THE SERVICES RELATED TO EMISSIONS CONTROL ARE GROUPED SEPARATELY. THESE SERVICES REQUIRE SPECIALIZED DATA, KNOWLEDGE, AND EQUIPMENT. YAMAHA DEALERS ARE TRAINED AND EQUIPPED TO PERFORM THESE PARTICULAR SERVICES.

Owner's tool kit

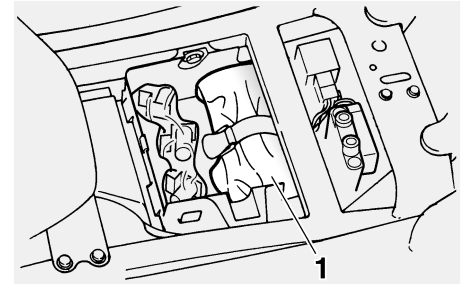

1. Owner's tool kit

The owner's tool kit is located under the rider seat. (See page 3-11.)

The service information included in this manual and the tools provided in the owner's tool kit are intended to assist you in the performance of preventive maintenance and minor repairs. However, additional tools such as a torque wrench may be necessary to perform certain maintenance work correctly.

NOTE:

If you do not have the tools or experience required for a particular job, have a Yamaha dealer perform it for you.

PERIODIC MAINTENANCE AND MINOR REPAIR

EWA10340

WARNING

Modifications not approved by Yamaha may cause loss of performance, excessive emissions, and render the vehicle unsafe for use. Consult a Yamaha dealer before attempting any changes.

PERIODIC MAINTENANCE AND MINOR REPAIR

EAU17600

Periodic maintenance chart for the emission control system

| No. | ITEM | ROUTINE | INITIAL | ODOMETER READINGS | | | | |
|-----|---|---|--------------------------------------|--|--|---|---|---|
| | | | 600 mi (1000 km) or 1 month | 4000 mi (7000 km) or 6 months | 8000 mi (13000 km) or 12 months | 12000 mi (19000 km) or 18 months | 16000 mi (25000 km) or 24 months | 20000 mi (31000 km) or 30 months |
| 1 | * Fuel line | <ul style="list-style-type: none"> Check fuel hoses for cracks or damage. Replace if necessary. | | √ | √ | √ | √ | √ |
| 2 | * Spark plugs | <ul style="list-style-type: none"> Check condition. Adjust gap and clean. Replace every 8000 mi (13000 km) or 12 months. | | √ | Replace. | √ | Replace. | √ |
| 3 | * Valve clearance | <ul style="list-style-type: none"> Check and adjust valve clearance when engine is cold. | Every 26600 mi (42000 km) | | | | | |
| 4 | * Crankcase breather system | <ul style="list-style-type: none"> Check breather hose for cracks or damage. Replace if necessary. | | √ | √ | √ | √ | √ |
| 5 | * Electronic fuel injection | <ul style="list-style-type: none"> Check and adjust engine idle speed and synchronization. | √ | √ | √ | √ | √ | √ |
| 6 | * Exhaust system | <ul style="list-style-type: none"> Check for leakage. Tighten if necessary. Replace gasket(s) if necessary. | | √ | √ | √ | √ | √ |
| 7 | * Evaporative emission control system (For California only) | <ul style="list-style-type: none"> Check control system for damage. Replace if necessary. | | | | √ | | |
| 8 | * Air induction system | <ul style="list-style-type: none"> Check the air cut-off valve, reed valve, and hose for damage. Replace any damaged parts. | | | √ | | √ | |

* Since these items require special tools, data and technical skills, have a Yamaha dealer perform the service.

PERIODIC MAINTENANCE AND MINOR REPAIR

EAU32182

General maintenance and lubrication chart

| No. | ITEM | ROUTINE | INITIAL | ODOMETER READINGS | | | | | |
|-----|------|---------------------------|--|--|--|---|---|---|---|
| | | | 600 mi (1000 km) or 1 month | 4000 mi (7000 km) or 6 months | 8000 mi (13000 km) or 12 months | 12000 mi (19000 km) or 18 months | 16000 mi (25000 km) or 24 months | 20000 mi (31000 km) or 30 months | |
| 1 | * | Air filter element | <ul style="list-style-type: none"> Clean with compressed air. Replace if necessary. | | √ | √ | √ | √ | √ |
| 2 | * | Clutch | <ul style="list-style-type: none"> Check operation and fluid leakage. Correct if necessary. | √ | √ | √ | √ | √ | √ |
| 3 | * | Front brake | <ul style="list-style-type: none"> Check operation, fluid level, and for fluid leakage. Replace brake pads if necessary. | √ | √ | √ | √ | √ | √ |
| 4 | * | Rear brake | <ul style="list-style-type: none"> Check operation, fluid level, and for fluid leakage. Replace brake pads if necessary. | √ | √ | √ | √ | √ | √ |
| 5 | * | Brake hoses | <ul style="list-style-type: none"> Check for cracks or damage. | | √ | √ | √ | √ | √ |
| | | | <ul style="list-style-type: none"> Replace. | Every 4 years | | | | | |
| 6 | * | Wheels | <ul style="list-style-type: none"> Check runout and for damage. Replace if necessary. | | √ | √ | √ | √ | √ |
| 7 | * | Tires | <ul style="list-style-type: none"> Check tread depth and for damage. Replace if necessary. Check air pressure. Correct if necessary. | | √ | √ | √ | √ | √ |
| 8 | * | Wheel bearings | <ul style="list-style-type: none"> Check bearings for smooth operation. Replace if necessary. | | √ | √ | √ | √ | √ |

PERIODIC MAINTENANCE AND MINOR REPAIR

| No. | ITEM | ROUTINE | INITIAL | ODOMETER READINGS | | | | | |
|-----|--|---|--------------------------------------|--|--|---|---|---|---|
| | | | 600 mi (1000 km) or 1 month | 4000 mi (7000 km) or 6 months | 8000 mi (13000 km) or 12 months | 12000 mi (19000 km) or 18 months | 16000 mi (25000 km) or 24 months | 20000 mi (31000 km) or 30 months | |
| 9 | * Swingarm pivot bearings | <ul style="list-style-type: none"> • Check bearing assemblies for looseness. • Moderately repack with lithium-soap-based grease. | | | √ | | | Repack. | |
| 10 | * Steering bearings | <ul style="list-style-type: none"> • Check bearing assemblies for looseness. • Moderately repack with lithium-soap-based grease every 16000 mi (25000 km) or 24 months. | √ | √ | √ | √ | | Repack. | √ |
| 11 | * Chassis fasteners | <ul style="list-style-type: none"> • Check all chassis fitting and fasteners. • Correct if necessary. | | √ | √ | √ | √ | √ | √ |
| 12 | Brake and clutch lever pivot shafts | <ul style="list-style-type: none"> • Apply lithium-soap-based grease (all-purpose grease) lightly. | | √ | √ | √ | √ | √ | √ |
| 13 | Brake and shift pedal pivot shafts | <ul style="list-style-type: none"> • Apply lithium-soap-based grease (all-purpose grease) lightly. | | √ | √ | √ | √ | √ | √ |
| 14 | * Centerstand and sidestand pivots | <ul style="list-style-type: none"> • Check operation. • Apply lithium-soap-based grease (all-purpose grease) lightly. | | √ | √ | √ | √ | √ | √ |
| 15 | * Sidestand switch | <ul style="list-style-type: none"> • Check operation and replace if necessary. | √ | √ | √ | √ | √ | √ | √ |
| 16 | * Front fork | <ul style="list-style-type: none"> • Check operation and for oil leakage. • Replace if necessary. | | √ | √ | √ | √ | √ | √ |
| 17 | * Shock absorber assembly | <ul style="list-style-type: none"> • Check operation and for oil leakage. • Replace if necessary. | | √ | √ | √ | √ | √ | √ |

PERIODIC MAINTENANCE AND MINOR REPAIR

| No. | ITEM | ROUTINE | INITIAL | ODOMETER READINGS | | | | | |
|-----|-----------------------------------|---|--------------------------------------|--|--|---|---|---|---------|
| | | | 600 mi (1000 km) or 1 month | 4000 mi (7000 km) or 6 months | 8000 mi (13000 km) or 12 months | 12000 mi (19000 km) or 18 months | 16000 mi (25000 km) or 24 months | 20000 mi (31000 km) or 30 months | |
| 18 | * Rear suspension link pivots | <ul style="list-style-type: none"> Apply lithium-soap-based grease lightly. | | | | | | √ | |
| 19 | Engine oil | <ul style="list-style-type: none"> Change (warm engine before draining). | √ | √ | √ | √ | √ | √ | √ |
| 20 | * Engine oil filter cartridge | <ul style="list-style-type: none"> Replace. | √ | | √ | | | √ | |
| 21 | * Cooling system | <ul style="list-style-type: none"> Check hoses for cracks or damage. Replace if necessary. | | √ | √ | √ | √ | √ | √ |
| | | <ul style="list-style-type: none"> Change with ethylene glycol anti-freeze coolant every 24 months. | | | | | | Change. | |
| 22 | * Final gear oil | <ul style="list-style-type: none"> Check oil level and for leakage. Change at initial 600 mi (1000 km) or 1 month, and thereafter every 16000 mi (25000 km) or 24 months. | Change. | | | √ | | | Change. |
| 23 | * Control cables | <ul style="list-style-type: none"> Apply Yamaha chain and cable lube or engine oil SAE 10W-30 thoroughly. | √ | √ | √ | √ | √ | √ | √ |
| 24 | * Throttle grip housing and cable | <ul style="list-style-type: none"> Check operation and free play. Adjust the throttle cable free play if necessary. Lubricate the throttle grip housing and cable. | | | √ | √ | √ | √ | √ |

* Since these items require special tools, data and technical skills, have a Yamaha dealer perform the service.

PERIODIC MAINTENANCE AND MINOR REPAIR

NOTE: _____

From 24000 mi (37000 km) or 36 months, repeat the maintenance intervals starting from 8000 mi (13000 km) or 12 months.

EAU17660

NOTE: _____

- The air filter needs more frequent service if you are riding in unusually wet or dusty areas.
 - Hydraulic brake and clutch systems
 - After disassembling the brake or clutch master cylinders, caliper cylinders or clutch release cylinder, always change the fluid. Regularly check the brake and clutch fluid levels and fill the reservoirs as required.
 - Replace the oil seals on the inner parts of the brake or clutch master cylinders, caliper cylinders and clutch release cylinder every two years.
 - Replace the brake and clutch hoses every four years or if cracked or damaged.
-

PERIODIC MAINTENANCE AND MINOR REPAIR

EAU18771

Removing and installing panels

The panels shown need to be removed to perform some of the maintenance jobs described in this chapter. Refer to this section each time a panel needs to be removed and installed.

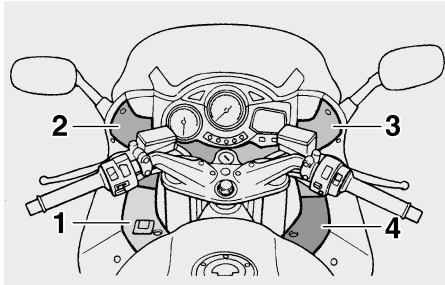

1. Panel A
2. Panel B
3. Panel C
4. Panel D

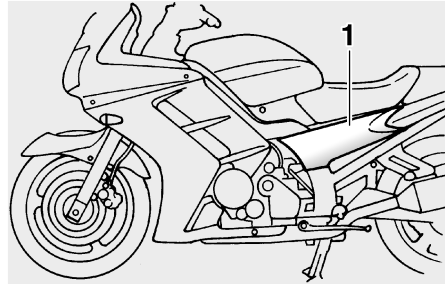

1. Panel E

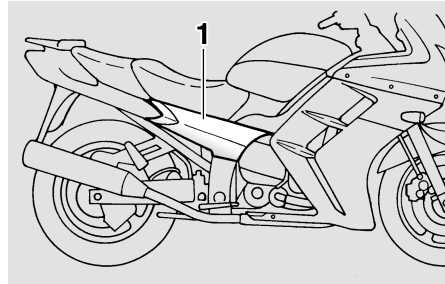

1. Panel F

Panel A

EAU33360

To remove the panel

Remove the bolts and the quick fastener screws, and then take the panel off.

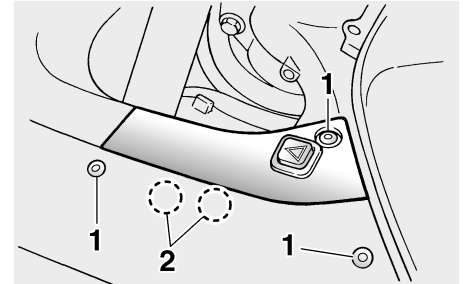

1. Bolt
2. Quick fastener screw

To install the panel

Place the panel in the original position, and then install the bolts and the quick fastener screws.

Panels B and C

EAU19312

To remove one of the panels

1. Remove panel A (if removing panel B) or panel D (if removing panel C).
2. Remove the quick fastener by pushing the center pin.
3. Remove the bolts, and then take the panel off.

PERIODIC MAINTENANCE AND MINOR REPAIR

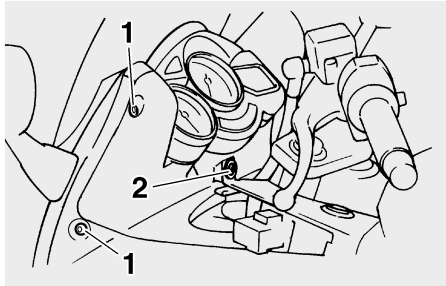

1. Bolt
2. Quick fastener

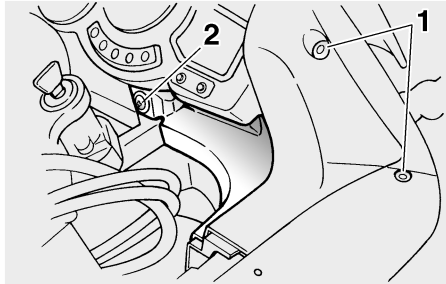

1. Bolt
2. Quick fastener

To install the panel

1. Place the panel in the original position, and then tighten the quick fastener and install the bolts.

2. Install panel A (to complete the installation of panel B) or panel D (to complete the installation of panel C).

Panel D

To remove the panel

Remove the bolts, and then take the panel off.

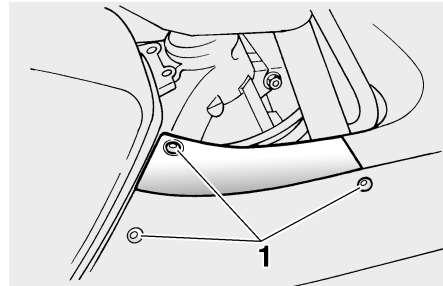

1. Bolt

To install the panel

Place the panel in the original position, and then install the bolts.

EAU19192

Panels E and F

EAU33370

To remove one of the panels

1. Remove the seats. (See page 3-11.)
2. Remove the bolts, the quick fastener screw and the quick fasteners, and then take the panel off.

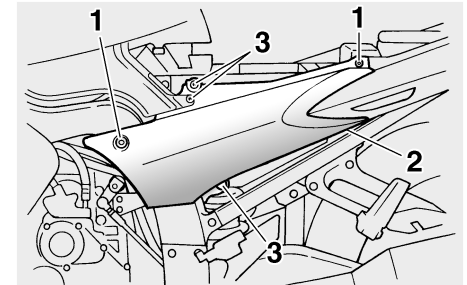

1. Bolt
2. Quick fastener screw
3. Quick fastener

To install the panel

1. Place the panel in the original position, and then install the quick fasteners and quick fastener screw, and tighten the bolts.
2. Install the seats.

PERIODIC MAINTENANCE AND MINOR REPAIR

Checking the spark plugs

EAU19641

The spark plugs are important engine components, which should be checked periodically, preferably by a Yamaha dealer. Since heat and deposits will cause any spark plug to slowly erode, they should be removed and checked in accordance with the periodic maintenance and lubrication chart. In addition, the condition of the spark plugs can reveal the condition of the engine.

The porcelain insulator around the center electrode of each spark plug should be a medium-to-light tan (the ideal color when the vehicle is ridden normally), and all spark plugs installed in the engine should have the same color. If any spark plug shows a distinctly different color, the engine could be defective. Do not attempt to diagnose such problems yourself. Instead, have a Yamaha dealer check the vehicle.

If a spark plug shows signs of electrode erosion and excessive carbon or other deposits, it should be replaced.

Specified spark plug:
NGK/CR8E
DENSO/U24ESR-N

Before installing a spark plug, the spark plug gap should be measured with a wire thickness gauge and, if necessary, adjusted to specification.

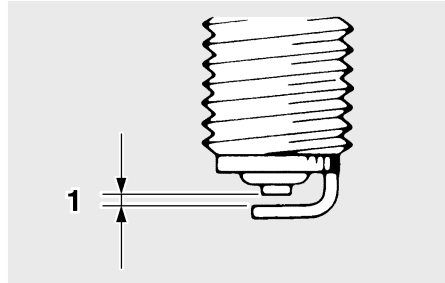

1. Spark plug gap

Spark plug gap:
0.7–0.8 mm (0.028–0.031 in)

Clean the surface of the spark plug gasket and its mating surface, and then wipe off any grime from the spark plug threads.

Tightening torque:

Spark plug:
12.5 Nm (1.25 m·kgf, 9.0 ft·lbf)

NOTE:

If a torque wrench is not available when installing a spark plug, a good estimate of the correct torque is 1/4–1/2 turn past finger tight. However, the spark plug should be tightened to the specified torque as soon as possible.

PERIODIC MAINTENANCE AND MINOR REPAIR

Canister (for California only)

EAU19681

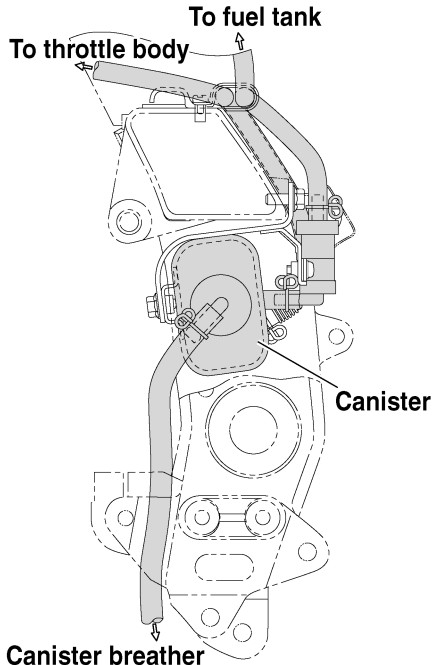

- Check each hose connection.
- Check each hose and canister for cracks or damage. Replace if damaged.
- Make sure that the canister breather is not blocked, and if necessary, clean it.

Engine oil and oil filter cartridge

EAU19881

The engine oil level should be checked before each ride. In addition, the oil must be changed and the oil filter cartridge replaced at the intervals specified in the periodic maintenance and lubrication chart.

To check the engine oil level

1. Place the vehicle on the center-stand.

NOTE: _____

Make sure that the vehicle is positioned straight up when checking the oil level. A slight tilt to the side can result in a false reading.

2. Start the engine, warm it up for several minutes, and then turn it off.
3. Wait a few minutes until the oil settles, and then check the oil level through the check window located at the bottom-left side of the crank-case.

This model is equipped with a canister to prevent the discharging of fuel vapor into the atmosphere. Before operating this vehicle, make sure to check the following:

PERIODIC MAINTENANCE AND MINOR REPAIR

NOTE:

The engine oil should be between the minimum and maximum level marks.

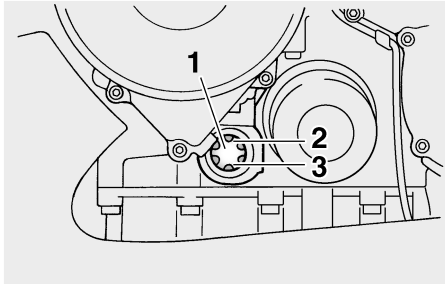

1. Engine oil level check window
2. Maximum level mark
3. Minimum level mark

4. If the engine oil is below the minimum level mark, add sufficient oil of the recommended type to raise it to the correct level.

To change the engine oil (with or without oil filter cartridge replacement)

1. Start the engine, warm it up for several minutes, and then turn it off.

2. Place an oil pan under the engine to collect the used oil.
3. Remove the engine oil filler cap and drain bolt to drain the oil from the crankcase.

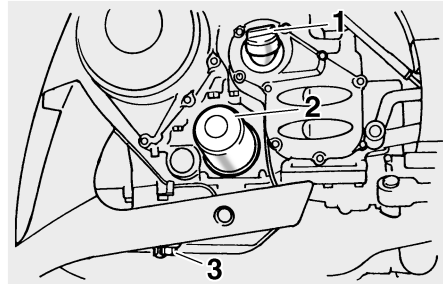

1. Engine oil filler cap
2. Oil filter cartridge
3. Engine oil drain bolt

NOTE:

Skip steps 4–6 if the oil filter cartridge is not being replaced.

4. Remove the oil filter cartridge with an oil filter wrench.

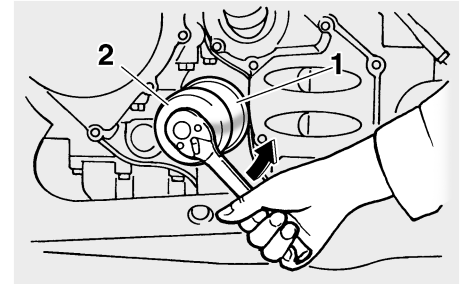

1. Oil filter cartridge
2. Oil filter wrench

NOTE:

An oil filter wrench is available at a Yamaha dealer.

5. Apply a thin coat of engine oil to the O-ring of the new oil filter cartridge.

PERIODIC MAINTENANCE AND MINOR REPAIR

ECA11620

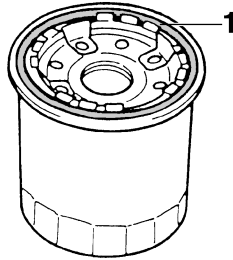

1. O-ring

NOTE:

Make sure that the O-ring is properly seated.

6. Install the new oil filter cartridge, and then tighten it to the specified torque with a torque wrench.

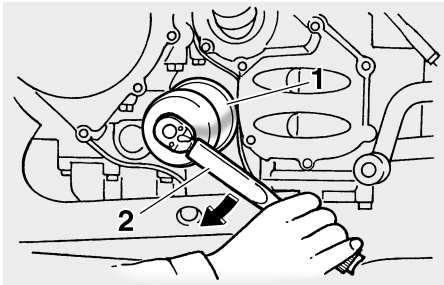

1. Oil filter cartridge
2. Torque wrench

Tightening torque:

Oil filter cartridge:
17 Nm (1.7 m·kgf, 12 ft·lbf)

7. Install the engine oil drain bolt, and then tighten it to the specified torque.

NOTE:

Check the washer for damage and replace it if necessary.

Tightening torque:

Engine oil drain bolt:
43 Nm (4.3 m·kgf, 31 ft·lbf)

8. Add the specified amount of the recommended engine oil, and then install and tighten the oil filler cap.

Recommended engine oil:

See page 8-1.

Oil quantity:

Without oil filter cartridge replacement:

3.80 L (4.02 US qt) (3.34 Imp.qt)

With oil filter cartridge replacement:

4.00 L (4.23 US qt) (3.52 Imp.qt)

CAUTION:

- In order to prevent clutch slippage (since the engine oil also lubricates the clutch), do not mix any chemical additives. Do not use oils with a diesel specification of “CD” or oils of a higher quality than specified. In addition, do not use oils labeled “ENERGY CONSERVING II” or higher.
- Make sure that no foreign material enters the crankcase.

9. Start the engine, and then let it idle for several minutes while checking it for oil leakage. If oil is leaking, immediately turn the engine off and check for the cause.

NOTE:

After the engine is started, the engine oil level warning light should go off if the oil level is sufficient.

PERIODIC MAINTENANCE AND MINOR REPAIR

ECA10400

CAUTION:

If the oil level warning light flickers or remains on, immediately turn the engine off and have a Yamaha dealer check the vehicle.

10. Turn the engine off, and then check the oil level and correct it if necessary.

Final gear oil

The final gear case must be checked for oil leakage before each ride. If any leakage is found, have a Yamaha dealer check and repair the vehicle. In addition, the final gear oil must be changed as follows at the intervals specified in the periodic maintenance and lubrication chart.

WARNING

- Make sure that no foreign material enters the final gear case.
- Make sure that no oil gets on the tire or wheel.

To check the final gear oil level

1. Place the vehicle on the center-stand.

NOTE:

- The final gear oil level must be checked on a cold engine.
- Make sure that the vehicle is positioned straight up when checking the oil level. A slight tilt to the side can result in a false reading.

EUA20011

2. Remove the oil filler bolt, and then check the oil level in the final gear case.

NOTE:

The oil level should be at the brim of the filler hole.

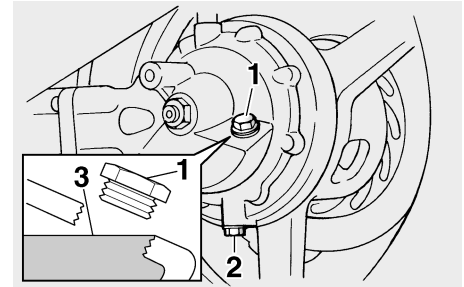

1. Final gear oil filler bolt
2. Final gear oil drain bolt
3. Correct oil level

3. If the oil is below the brim of the filler hole, add sufficient oil of the recommended type to raise it to the correct level.
4. Install the oil filler bolt, and then tighten it to the specified torque.

PERIODIC MAINTENANCE AND MINOR REPAIR

EAU20070

Tightening torque:

Final gear oil filler bolt:
23 Nm (2.3 m·kgf, 17 ft·lbf)

Tightening torque:

Final gear oil filler bolt:
23 Nm (2.3 m·kgf, 17 ft·lbf)

Coolant

The coolant level should be checked before each ride. In addition, the coolant must be changed at the intervals specified in the periodic maintenance and lubrication chart.

EAU20261

To check the coolant level

The coolant level should be checked as follows before each ride. In addition, the coolant must be changed at the intervals specified in the periodic maintenance and lubrication chart.

1. Place the vehicle on the center-stand.

NOTE:

- The coolant level must be checked on a cold engine since the level varies with engine temperature.
 - Make sure that the vehicle is positioned straight up when checking the coolant level. A slight tilt to the side can result in a false reading.
2. Check the coolant level in the coolant reservoir.

To change the final gear oil

1. Place an oil pan under the final gear case to collect the used oil.
2. Remove the oil filler bolt and drain bolt to drain the oil from the final gear case.
3. Install the final gear oil drain bolt, and then tighten it to the specified torque.

Tightening torque:

Final gear oil drain bolt:
23 Nm (2.3 m·kgf, 17 ft·lbf)

4. Add the recommended final gear oil to the brim of the filler hole.

Recommended final gear oil:

Shaft drive gear oil (Part No.: 9079E-SH001-00)

Oil quantity:

0.20 L (0.21 US qt) (0.18 Imp.qt)

5. Install the oil filler bolt, and then tighten it to the specified torque.

PERIODIC MAINTENANCE AND MINOR REPAIR

NOTE: _____
The coolant should be between the minimum and maximum level marks.

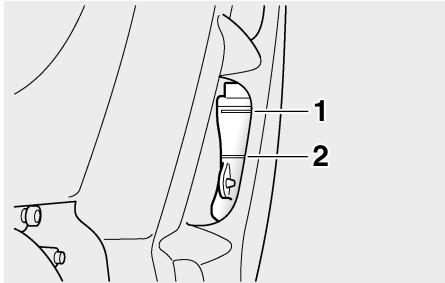

1. Maximum level mark
2. Minimum level mark

3. If the coolant is at or below the minimum level mark, remove the bolt, the coolant reservoir cap cover and the reservoir cap.

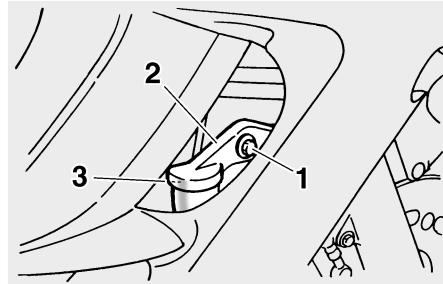

1. Bolt
2. Coolant reservoir cap cover
3. Coolant reservoir cap

4. Add coolant or distilled water to raise the coolant to the maximum level mark, install the coolant reservoir cap, the coolant reservoir cap cover and the bolt.

Coolant reservoir capacity (up to the maximum level mark):
0.25 L (0.26 US qt) (0.22 Imp.qt)

ECA10470

CAUTION: _____

- If coolant is not available, use distilled water or soft tap water instead. Do not use hard water or salt water since it is harmful to the engine.

- If water has been used instead of coolant, replace it with coolant as soon as possible, otherwise the engine may not be sufficiently cooled and the cooling system will not be protected against frost and corrosion.
- If water has been added to the coolant, have a Yamaha dealer check the antifreeze content of the coolant as soon as possible, otherwise the effectiveness of the coolant will be reduced.

EWA10380

! WARNING _____

Never attempt to remove the radiator cap when the engine is hot.

NOTE: _____

- The radiator fan is automatically switched on or off according to the coolant temperature in the radiator.
- If the engine overheats, see page 6-36 for further instructions.

PERIODIC MAINTENANCE AND MINOR REPAIR

Changing the coolant

EAU33030

EWA10380

WARNING

Never attempt to remove the radiator cap when the engine is hot.

The coolant must be changed at the intervals specified in the periodic maintenance and lubrication chart. Have a Yamaha dealer change the coolant.

Cleaning the air filter element

EAU20470

The air filter element should be cleaned at the intervals specified in the periodic maintenance and lubrication chart. Clean the air filter element more frequently if you are riding in unusually wet or dusty areas.

1. Remove panel E. (See page 6-8.)
2. Remove the intake air shroud by removing the quick fastener screws.

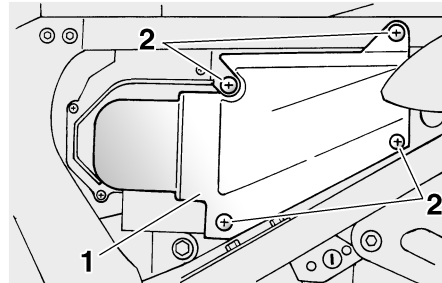

1. Intake air shroud
2. Quick fastener screw

3. Remove the air filter case cover by removing the screws.

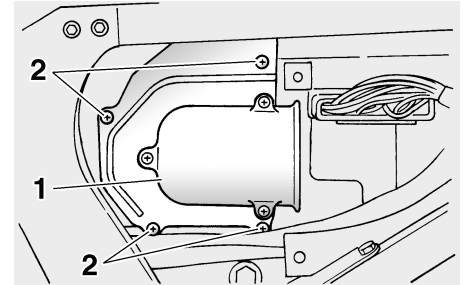

1. Air filter case cover
2. Screw

4. Pull the air filter element out.

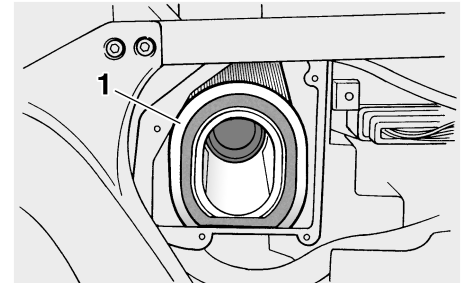

1. Air filter element

5. Lightly tap the air filter element to remove most of the dust and dirt, and then blow the remaining dirt

PERIODIC MAINTENANCE AND MINOR REPAIR

out with compressed air as shown. If the air filter element is damaged, replace it.

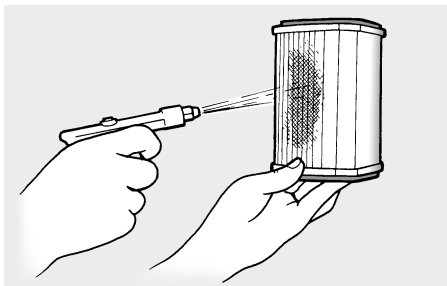

6. Insert the air filter element into the air filter case.

ECA10480

CAUTION:

- **Make sure that the air filter element is properly seated in the air filter case.**
- **The engine should never be operated without the air filter element installed, otherwise the piston(s) and/or cylinder(s) may become excessively worn.**

7. Install the air filter case cover by installing the screws.

8. Install the intake air shroud by installing the quick fastener screws.

9. Install the panel.

Adjusting the throttle cable free play

EAU21380

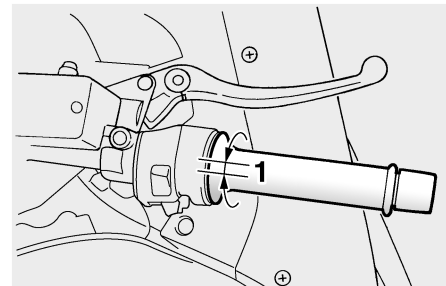

1. Throttle cable free play

The throttle cable free play should measure 3.0–5.0 mm (0.12–0.20 in) at the throttle grip. Periodically check the throttle cable free play and, if necessary, have a Yamaha dealer adjust it.

PERIODIC MAINTENANCE AND MINOR REPAIR

Adjusting the valve clearance

EAU21400

The valve clearance changes with use, resulting in improper air-fuel mixture and/or engine noise. To prevent this from occurring, the valve clearance must be adjusted by a Yamaha dealer at the intervals specified in the periodic maintenance and lubrication chart.

Tires

EAU21750

To maximize the performance, durability, and safe operation of your motorcycle, note the following points regarding the specified tires.

Tire air pressure

The tire air pressure should be checked and, if necessary, adjusted before each ride.

EWA10500

WARNING

- The tire air pressure must be checked and adjusted on cold tires (i.e., when the temperature of the tires equals the ambient temperature).
- The tire air pressure must be adjusted in accordance with the riding speed and with the total weight of rider, passenger, cargo, and accessories approved for this model.

Tire air pressure (measured on cold tires):

0–90 kg (0–198 lb):

Front:

250 kPa (36 psi) (2.50 kgf/cm²)

Rear:

250 kPa (36 psi) (2.50 kgf/cm²)

FJR1300 90–200 kg (198–441 lb) (CAL)

FJR1300 90–201 kg (198–443 lb) (U49)

FJR1300A 90–193 kg (198–425 lb) (CAL)

FJR1300A 90–194 kg (198–428 lb) (U49):

Front:

250 kPa (36 psi) (2.50 kgf/cm²)

Rear:

290 kPa (42 psi) (2.90 kgf/cm²)

High-speed riding:

Front:

250 kPa (36 psi) (2.50 kgf/cm²)

Rear:

250 kPa (36 psi) (2.50 kgf/cm²)

Maximum load*:

FJR1300 200 kg (441 lb) (CAL)

FJR1300 201 kg (443 lb) (U49)

FJR1300A 193 kg (425 lb) (CAL)

FJR1300A 194 kg (428 lb) (U49)

* Total weight of rider, passenger, cargo and accessories

PERIODIC MAINTENANCE AND MINOR REPAIR

EWA10510

WARNING

Proper loading of your vehicle is important for several characteristics of your vehicle, such as handling, braking, performance and safety. Do not carry loosely packed items that can shift. Securely pack your heaviest items close to the center of the vehicle, and distribute the weight evenly from side to side. Properly adjust the suspension for your load, and check the condition and pressure of your tires. **NEVER OVERLOAD YOUR VEHICLE.** Make sure that the total weight of the cargo, rider, passenger, and accessories (cowling, saddlebags, etc. if approved for this model) does not exceed the maximum load of the vehicle. Operation of an overloaded vehicle could cause tire damage, an accident, or even injury.

Tire inspection

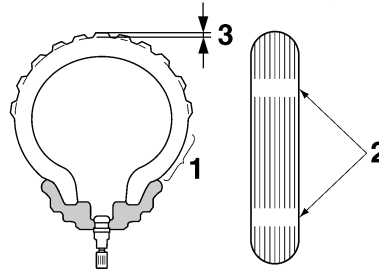

1. Tire sidewall
2. Tire wear indicator
3. Tire tread depth

Always check the tires before operating the motorcycle. If a tire tread shows crosswise lines (minimum tread depth), if the tire has a nail or glass fragments in it, or if the sidewall is cracked, contact a Yamaha dealer immediately and have the tire replaced.

Minimum tire tread depth (front and rear):
1.0 mm (0.04 in)

EWA10580

WARNING

- It is dangerous to ride with a worn-out tire. When a tire tread begins to show crosswise lines, have a Yamaha dealer replace the tire immediately.
- The replacement of all wheel- and brake-related parts, including the tires, should be left to a Yamaha dealer, who has the necessary professional knowledge and experience.

Tire information

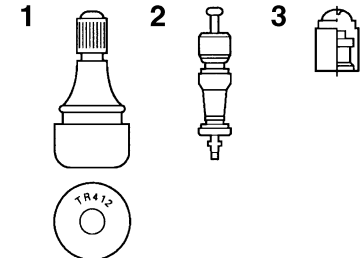

1. Tire air valve
2. Tire air valve core
3. Tire air valve cap with seal

PERIODIC MAINTENANCE AND MINOR REPAIR

This motorcycle is equipped with cast wheels and tubeless tires with valves.

EWA10480

WARNING

- The front and rear tires should be of the same make and design, otherwise the handling characteristics of the motorcycle cannot be guaranteed.
- After extensive tests, only the tires listed below have been approved for this model by Yamaha Motor Co., Ltd.
- Always make sure that the valve caps are securely installed to prevent air pressure leakage.
- Use only the tire valves and valve cores listed below to avoid tire deflation during a high-speed ride.

Front tire:

Size:

120/70 ZR17M/C (58W)

Manufacturer/model:

METZELER/MEZ4J FRONT
BRIDGESTONE/BT020F N

Rear tire:

Size:

180/55 ZR17M/C (73W)

Manufacturer/model:

METZELER/MEZ4J
BRIDGESTONE/BT020R N

FRONT and REAR:

Tire air valve:

TR412

Valve core:

#9000A (original)

EWA10600

WARNING

This motorcycle is fitted with super-high-speed tires. Note the following points in order to make the most efficient use of these tires.

- Use only the specified replacement tires. Other tires may run the danger of bursting at super high speeds.
- Brand-new tires can have a relatively poor grip on certain road surfaces until they have been

“broken in”. Therefore, it is advisable before doing any high-speed riding to ride conservatively for approximately 100 km (60 mi) after installing a new tire.

- The tires must be warmed up before a high-speed run.
- Always adjust the tire air pressure according to the operating conditions.

Cast wheels

EAU21960

To maximize the performance, durability, and safe operation of your vehicle, note the following points regarding the specified wheels.

- The wheel rims should be checked for cracks, bends or warpage before each ride. If any damage is found, have a Yamaha dealer replace the wheel. Do not attempt even the smallest repair to the wheel. A deformed or cracked wheel must be replaced.
- The wheel should be balanced whenever either the tire or wheel has been changed or replaced. An unbalanced wheel can result in poor performance, adverse handling characteristics, and a shortened tire life.
- Ride at moderate speeds after changing a tire since the tire surface must first be “broken in” for it to develop its optimal characteristics.

Accessories and replacement parts

EAU22011

EWA10621



This vehicle is not designed to pull a trailer or to be attached to a sidecar. The accessories or replacement parts you choose for your vehicle should be designed specifically for this model, and they must be securely mounted to maintain the inherent stability of the original design. Genuine Yamaha Parts and Accessories are designed and tested to be compatible with your vehicle. Please consider Genuine Yamaha Parts and Accessories before making a purchase. Use of non-Yamaha-approved accessories or replacement parts may cause loss of handling stability and riding safety. Since Yamaha cannot control the quality of accessories or parts manufactured by other companies, Yamaha cannot be held liable for

any consequences caused by the use of items which have not been approved by Yamaha.

PERIODIC MAINTENANCE AND MINOR REPAIR

Clutch lever free play

Since this model is equipped with a hydraulic clutch, adjusting the clutch lever free play is not needed. However, it is necessary to check the clutch fluid level and check the hydraulic system for leakage before each ride. If the clutch lever free play does become excessive, and shifting becomes rough or clutch slippage occurs, causing poor acceleration, there may be air in the clutch system. If there is air in the hydraulic system, have a Yamaha dealer bleed the system before operating the motor-cycle.

EAU22071

Adjusting the rear brake light switch

EAU22270

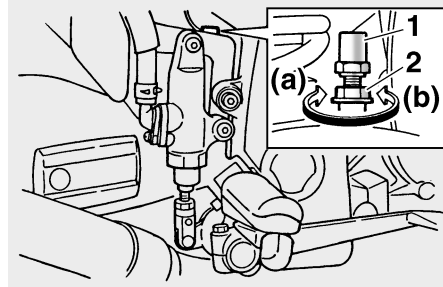

1. Rear brake light switch
2. Rear brake light switch adjusting nut

The rear brake light switch, which is activated by the brake pedal, is properly adjusted when the brake light comes on just before braking takes effect. If necessary, adjust the brake light switch as follows.

Turn the adjusting nut while holding the rear brake light switch in place. To make the brake light come on earlier, turn the adjusting nut in direction (a). To make the brake light come on later, turn the adjusting nut in direction (b).

Checking the front and rear brake pads

EAU22390

The front and rear brake pads must be checked for wear at the intervals specified in the periodic maintenance and lubrication chart.

Front brake pads

EAU22420

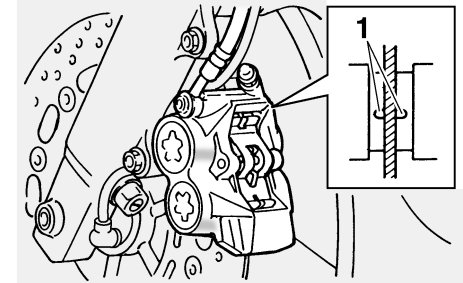

1. Brake pad wear indicator groove

Each front brake pad is provided with a wear indicator groove, which allows you to check the brake pad wear without having to disassemble the brake. To check the brake pad wear, check the wear indicator groove. If a brake pad has worn to the point that the wear

PERIODIC MAINTENANCE AND MINOR REPAIR

indicator groove has almost disappeared, have a Yamaha dealer replace the brake pads as a set.

Rear brake pads

EAU22500

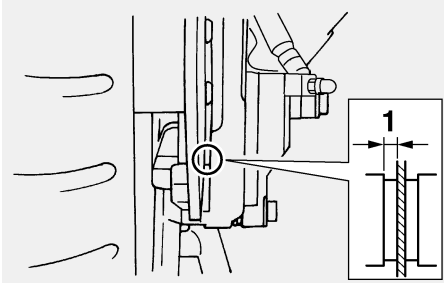

1. Lining thickness

Check each rear brake pad for damage and measure the lining thickness. If a brake pad is damaged or if the lining thickness is less than 0.8 mm (0.03 in), have a Yamaha dealer replace the brake pads as a set.

Checking the brake and clutch fluid levels

EAU22680

Front brake

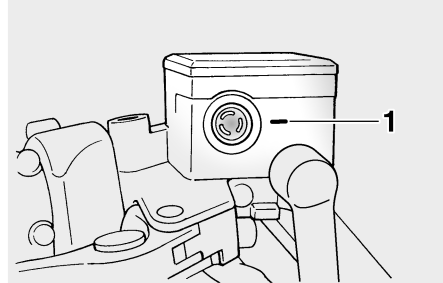

1. Minimum level mark

Rear brake

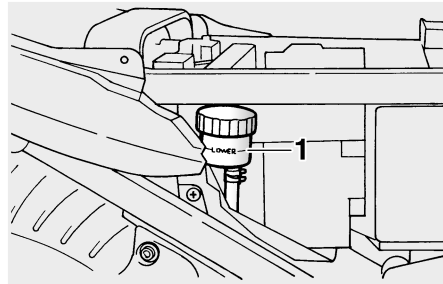

1. Minimum level mark

Clutch

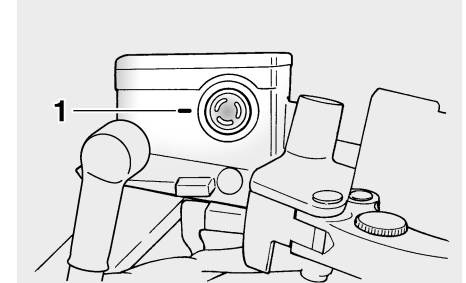

1. Minimum level mark

Insufficient brake fluid may allow air to enter the brake or clutch systems, possibly causing them to become ineffective.

Before riding, check that the brake fluid is above the minimum level mark and replenish if necessary. A low brake fluid level may indicate worn brake pads and/or brake system leakage. If the brake level is low, be sure to check the brake pads for wear and the brake system for leakage.

NOTE:

The rear brake fluid reservoir is located behind panel F. (See page 6-8.)

Observe these precautions:

PERIODIC MAINTENANCE AND MINOR REPAIR

EAU22750

- When checking the fluid level, make sure that the top of the brake or clutch fluid reservoir is level.
- Use only the recommended quality brake fluid, otherwise the rubber seals may deteriorate, causing leakage and poor braking or clutch performance.

Recommended brake and clutch fluid:

DOT 4 brake fluid

- Refill with the same type of brake fluid. Mixing fluids may result in a harmful chemical reaction and lead to poor braking or clutch performance.
- The brake or clutch fluid reservoir diaphragm will lose its shape from the negative pressure if the fluid level goes down too far. Be sure to return the diaphragm to its original shape before installing it into the brake or clutch fluid reservoir.
- Be careful that water does not enter the brake or clutch fluid reservoir when refilling. Water will

significantly lower the boiling point of the fluid and may result in vapor lock.

- Brake fluid may deteriorate painted surfaces or plastic parts. Always clean up spilled fluid immediately.
- As the brake pads wear, it is normal for the brake fluid level to gradually go down. However, if the brake fluid level goes down suddenly, have a Yamaha dealer check the cause.

Changing the brake and clutch fluids

Have a Yamaha dealer change the brake and clutch fluids at the intervals specified in the NOTE after the periodic maintenance and lubrication chart. In addition, have the oil seals of the brake and clutch master cylinders and calipers as well as the brake and clutch hoses replaced at the intervals listed below or whenever they are damaged or leaking.

- Oil seals: Replace every two years.
- Brake and clutch hoses: Replace every four years.

PERIODIC MAINTENANCE AND MINOR REPAIR

Checking and lubricating the cables

EAU23090

The operation of all control cables and the condition of the cables should be checked before each ride, and the cables and cable ends should be lubricated if necessary. If a cable is damaged or does not move smoothly, have a Yamaha dealer check or replace it.

Recommended lubricant:

Yamaha Chain and Cable Lube or engine oil SAE 10W-30 (API SE)

EWA10710

WARNING

Damage to the outer housing of cables may result in internal rusting and cause interference with cable movement. Replace damaged cables as soon as possible to prevent unsafe conditions.

Checking and lubricating the throttle grip and cable

EAU23110

The operation of the throttle grip should be checked before each ride. In addition, the cable should be lubricated or replaced at the intervals specified in the periodic maintenance chart.

Checking and lubricating the brake and shift pedals

EAU23131

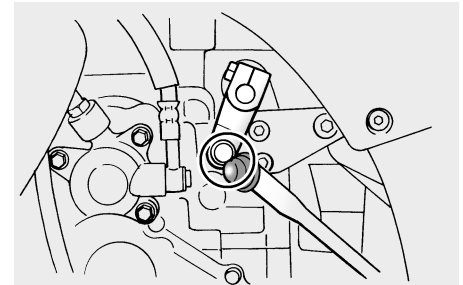
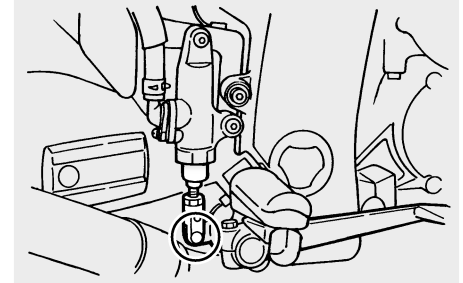

The operation of the brake and shift pedals should be checked before each ride, and the pedal pivots should be lubricated if necessary.

PERIODIC MAINTENANCE AND MINOR REPAIR

Recommended lubricant:

Lithium-soap-based grease (all-purpose grease)

Checking and lubricating the brake and clutch levers

EAU23140

Recommended lubricant:

Lithium-soap-based grease (all-purpose grease)

Brake lever

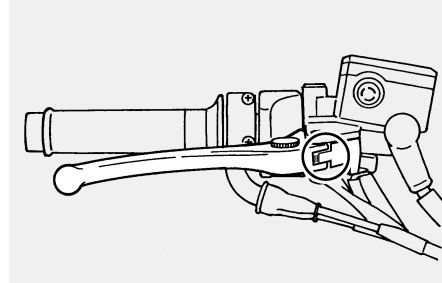

Clutch lever

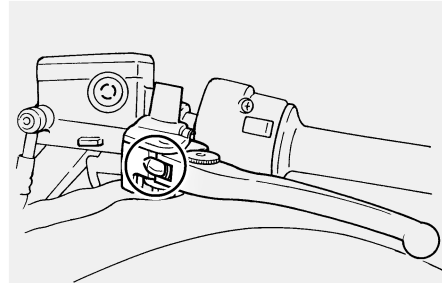

The operation of the brake and clutch levers should be checked before each ride, and the lever pivots should be lubricated if necessary.

PERIODIC MAINTENANCE AND MINOR REPAIR

Checking and lubricating the centerstand and sidestand

EAU23210

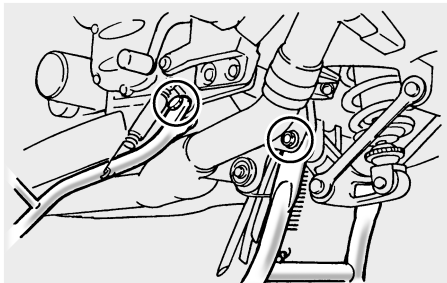

The operation of the centerstand and sidestand should be checked before each ride, and the pivots and metal-to-metal contact surfaces should be lubricated if necessary.

EWA10740

WARNING

If the centerstand or sidestand does not move up and down smoothly, have a Yamaha dealer check or repair it.

Recommended lubricant:

Lithium-soap-based grease (all-purpose grease)

Lubricating the rear suspension

EAU23250

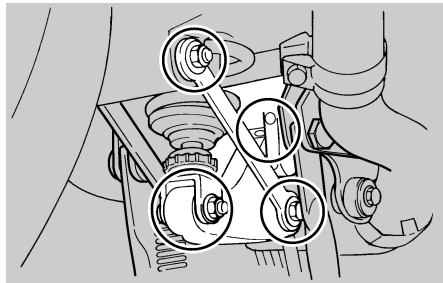

The pivoting points of the rear suspension must be lubricated at the intervals specified in the periodic maintenance and lubrication chart.

Recommended lubricant:

Lithium-soap-based grease

Checking the front fork

EAU23271

The condition and operation of the front fork must be checked as follows at the intervals specified in the periodic maintenance and lubrication chart.

To check the condition

EWA10750

WARNING

Securely support the vehicle so that there is no danger of it falling over.

Check the inner tubes for scratches, damage and excessive oil leakage.

To check the operation

1. Place the vehicle on a level surface and hold it in an upright position.
2. While applying the front brake, push down hard on the handlebars several times to check if the front fork compresses and rebounds smoothly.

PERIODIC MAINTENANCE AND MINOR REPAIR

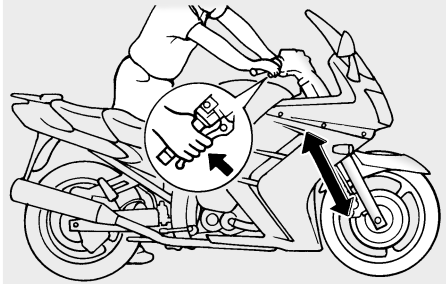

ECA10590

CAUTION:

If any damage is found or the front fork does not operate smoothly, have a Yamaha dealer check or repair it.

6

Checking the steering

EAU23280

Worn or loose steering bearings may cause danger. Therefore, the operation of the steering must be checked as follows at the intervals specified in the periodic maintenance and lubrication chart.

1. Place a stand under the engine to raise the front wheel off the ground.

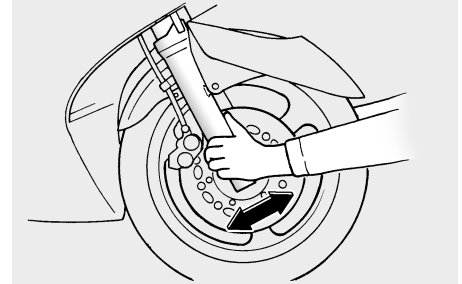

EWA10750

WARNING

Securely support the vehicle so that there is no danger of it falling over.

2. Hold the lower ends of the front fork legs and try to move them forward and backward. If any free play can be felt, have a Yamaha dealer check or repair the steering.

PERIODIC MAINTENANCE AND MINOR REPAIR

Checking the wheel bearings

EAU23290

The front and rear wheel bearings must be checked at the intervals specified in the periodic maintenance and lubrication chart. If there is play in the wheel hub or if the wheel does not turn smoothly, have a Yamaha dealer check the wheel bearings.

Battery

EAU23400

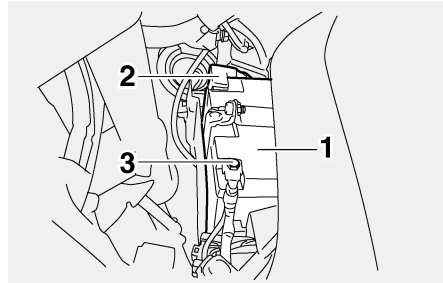

1. Battery
2. Positive battery terminal
3. Negative battery terminal

The battery is located under panels C and D. (See page 6-8.)

This vehicle is equipped with a sealed-type (MF) battery, which does not require any maintenance. There is no need to check the electrolyte or to add distilled water.

To charge the battery

Have a Yamaha dealer charge the battery as soon as possible if it seems to have discharged. Keep in mind that the

battery tends to discharge more quickly if the vehicle is equipped with optional electrical accessories.

EWA10760

! WARNING

- **Electrolyte is poisonous and dangerous since it contains sulfuric acid, which causes severe burns. Avoid any contact with skin, eyes or clothing and always shield your eyes when working near batteries. In case of contact, administer the following FIRST AID.**
 - **EXTERNAL:** Flush with plenty of water.
 - **INTERNAL:** Drink large quantities of water or milk and immediately call a physician.
 - **EYES:** Flush with water for 15 minutes and seek prompt medical attention.
- **Batteries produce explosive hydrogen gas. Therefore, keep sparks, flames, cigarettes, etc., away from the battery and provide sufficient ventilation when charging it in an enclosed space.**

PERIODIC MAINTENANCE AND MINOR REPAIR

- **KEEP THIS AND ALL BATTERIES OUT OF THE REACH OF CHILDREN.**

To store the battery

1. If the vehicle will not be used for more than one month, remove the battery, fully charge it, and then place it in a cool, dry place.
2. If the battery will be stored for more than two months, check it at least once a month and fully charge it if necessary.
3. Fully charge the battery before installation.
4. After installation, make sure that the battery leads are properly connected to the battery terminals.

ECA10630

CAUTION:

- **Always keep the battery charged. Storing a discharged battery can cause permanent battery damage.**
- **To charge a sealed-type (MF) battery, a special (constant-voltage) battery charger is required. Using a conventional battery**

charger will damage the battery. If you do not have access to a sealed-type (MF) battery charger, have a Yamaha dealer charge your battery.

Replacing the fuses

EAU23652

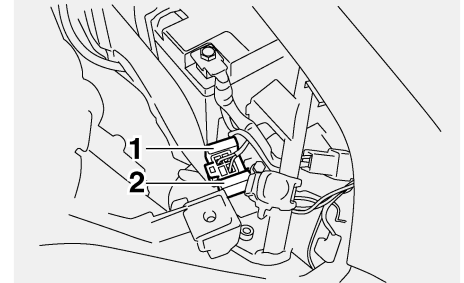

1. Electronic fuel injection fuse
2. Electronic fuel injection spare fuse

The fuse box, which contains the fuses for the individual circuits, is located under panel A. Both the electronic fuel injection fuse and the main fuse are located under panel D. The main fuse is located beside the battery. (See page 6-8.)

PERIODIC MAINTENANCE AND MINOR REPAIR

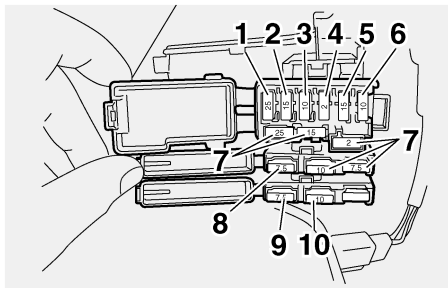

1. Headlight fuse
2. Signaling system fuse
3. Ignition fuse
4. Windshield motor fuse
5. Radiator fan fuse
6. Backup fuse (for odometer and clock)
7. Spare fuse
8. Hazard fuse
9. ABS control unit fuse (for ABS models)
10. Tail/position light fuse

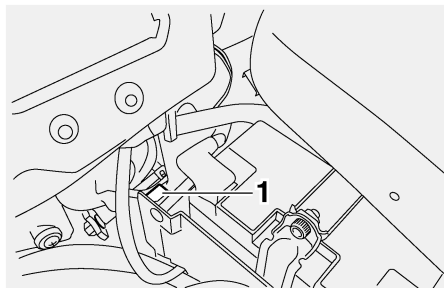

1. Main fuse

If a fuse is blown, replace it as follows.

1. Turn the key to "OFF" and turn off the electrical circuit in question.
2. Remove the blown fuse, and then install a new fuse of the specified amperage.

Specified fuses:

- Main fuse:
 - 50.0 A
- Headlight fuse:
 - 25.0 A
- Signaling system fuse:
 - 15.0 A
- Ignition fuse:
 - 10.0 A
- Windshield motor fuse:
 - 2.0 A
- Radiator fan fuse:
 - 15.0 A
- Backup fuse:
 - 10.0 A
- Hazard fuse:
 - 7.5 A
- Electronic fuel injection fuse:
 - 15.0 A
- ABS control unit fuse:
 - FJR1300A 7.5 A
- ABS motor fuse:
 - FJR1300A 30.0 A
- Tail/position light fuse:
 - 10.0 A

PERIODIC MAINTENANCE AND MINOR REPAIR

ECA10640

CAUTION:

Do not use a fuse of a higher amperage rating than recommended to avoid causing extensive damage to the electrical system and possibly a fire.

3. Turn the key to "ON" and turn on the electrical circuit in question to check if the device operates.
4. If the fuse immediately blows again, have a Yamaha dealer check the electrical system.

EAU23900

Replacing a headlight bulb

This model is equipped with quartz bulb headlights. If a headlight bulb burns out, replace it as follows.

1. Remove panel B (if replacing the left headlight bulb) or panel C (if replacing the right headlight bulb). (See page 6-8.)
2. Disconnect the headlight coupler, and then remove the headlight bulb cover.

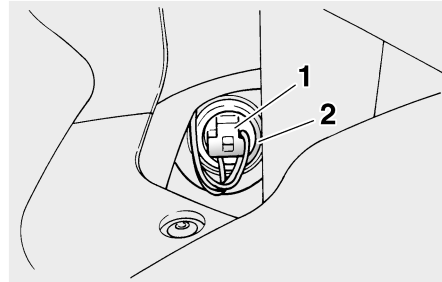

1. Headlight coupler
2. Headlight bulb cover

3. Unhook the headlight bulb holder, and then remove the defective bulb.

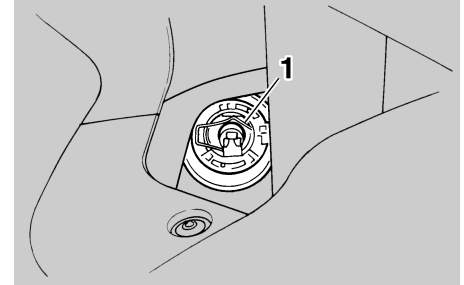

1. Headlight bulb holder

EWA10790

⚠ WARNING

Headlight bulbs get very hot. Therefore, keep flammable products away from a lit headlight bulb, and do not touch the bulb until it has cooled down.

4. Place a new headlight bulb into position, and then secure it with the bulb holder.

ECA10650

CAUTION:

Take care not to damage the following parts:

PERIODIC MAINTENANCE AND MINOR REPAIR

● Headlight bulb

Do not touch the glass part of the headlight bulb to keep it free from oil, otherwise the transparency of the glass, the luminosity of the bulb, and the bulb life will be adversely affected. Thoroughly clean off any dirt and fingerprints on the headlight bulb using a cloth moistened with alcohol or thinner.

● Headlight lens

Do not affix any type of tinted film or stickers to the headlight lens.

Do not use a headlight bulb of a wattage higher than specified.

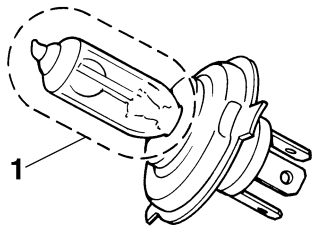

1. Do not touch the glass part of the bulb.

5. Install the headlight bulb cover, and then connect the coupler.
6. Install the panel.
7. Have a Yamaha dealer adjust the headlight beam if necessary.

Replacing a rear turn signal light bulb or a tail/brake light bulb

EAU27000

1. Remove the passenger seat. (See page 3-11.)
2. Remove the socket (together with the bulb) by turning it counterclockwise.

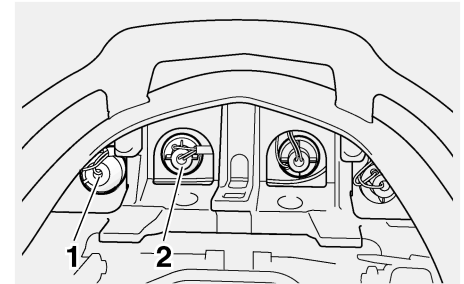

1. Turn signal light bulb socket
2. Tail/brake light bulb socket

3. Remove the defective bulb by turning it counterclockwise.
4. Insert a new bulb into the socket, push it in, and then turn it clockwise until it stops.
5. Install the socket (together with the bulb) by turning it clockwise.
6. Install the passenger seat.

PERIODIC MAINTENANCE AND MINOR REPAIR

EAU25870

Troubleshooting

Although Yamaha motorcycles receive a thorough inspection before shipment from the factory, trouble may occur during operation. Any problem in the fuel, compression, or ignition systems, for example, can cause poor starting and loss of power.

The following troubleshooting charts represent quick and easy procedures for checking these vital systems yourself. However, should your motorcycle require any repair, take it to a Yamaha dealer, whose skilled technicians have the necessary tools, experience, and know-how to service the motorcycle properly.

Use only genuine Yamaha replacement parts. Imitation parts may look like Yamaha parts, but they are often inferior, have a shorter service life and can lead to expensive repair bills.

PERIODIC MAINTENANCE AND MINOR REPAIR

EAU25911

Troubleshooting charts

Starting problems or poor engine performance

EWA10840



WARNING

Keep away open flames and do not smoke while checking or working on the fuel system.

1. Fuel

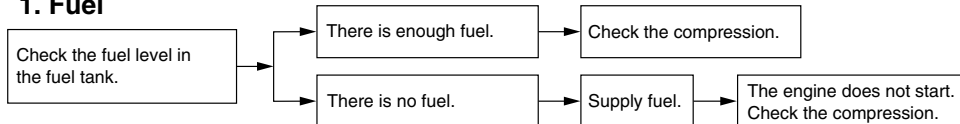

2. Compression

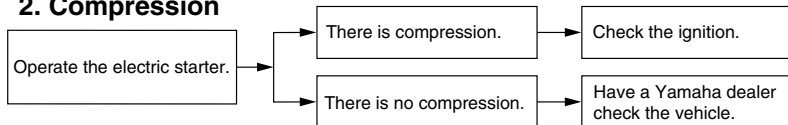

3. Ignition

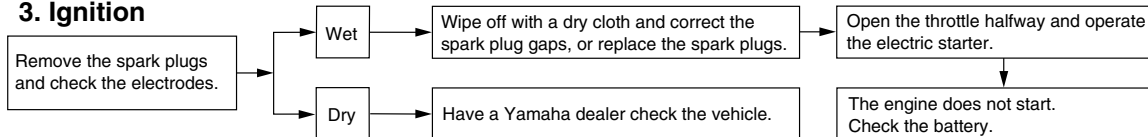

4. Battery

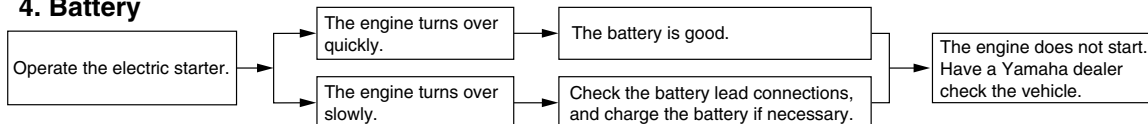

PERIODIC MAINTENANCE AND MINOR REPAIR

Engine overheating

EWA10400

WARNING

- Do not remove the radiator cap when the engine and radiator are hot. Scalding hot fluid and steam may be blown out under pressure, which could cause serious injury. Be sure to wait until the engine has cooled.
- After removing the radiator cap retaining bolt, place a thick rag, like a towel, over the radiator cap, and then slowly rotate the cap counterclockwise to the detent to allow any residual pressure to escape. When the hissing sound has stopped, press down on the cap while turning it counterclockwise, and then remove the cap.

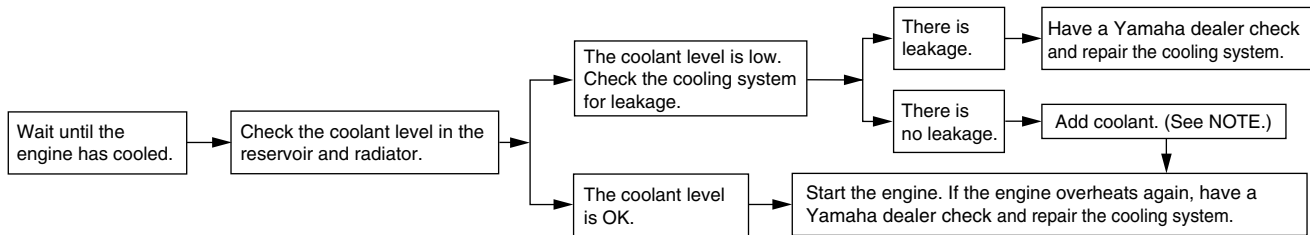

6

NOTE:

If coolant is not available, tap water can be temporarily used instead, provided that it is changed to the recommended coolant as soon as possible.

MOTORCYCLE CARE AND STORAGE

Care

EAU26060

While the open design of a motorcycle reveals the attractiveness of the technology, it also makes it more vulnerable. Rust and corrosion can develop even if high-quality components are used. A rusty exhaust pipe may go unnoticed on a car, however, it detracts from the overall appearance of a motorcycle. Frequent and proper care does not only comply with the terms of the warranty, but it will also keep your motorcycle looking good, extend its life and optimize its performance.

Before cleaning

1. Cover the muffler outlets with plastic bags after the engine has cooled down.
2. Make sure that all caps and covers as well as all electrical couplers and connectors, including the spark plug caps, are tightly installed.
3. Remove extremely stubborn dirt, like oil burnt onto the crankcase, with a degreasing agent and a brush, but never apply such prod-

ucts onto seals, gaskets and wheel axles. Always rinse the dirt and degreaser off with water.

Cleaning

ECA10770

CAUTION:

- **Avoid using strong acidic wheel cleaners, especially on spoked wheels. If such products are used on hard-to-remove dirt, do not leave the cleaner on the affected area any longer than instructed. Also, thoroughly rinse the area off with water, immediately dry it, and then apply a corrosion protection spray.**
 - **Improper cleaning can damage windshields, cowlings, panels and other plastic parts. Use only a soft, clean cloth or sponge with mild detergent and water to clean plastic.**
 - **Do not use any harsh chemical products on plastic parts. Be sure to avoid using cloths or sponges which have been in contact with strong or abrasive cleaning products, solvent or**
- thinner, fuel (gasoline), rust removers or inhibitors, brake fluid, antifreeze or electrolyte.
- **Do not use high-pressure washers or steam-jet cleaners since they cause water seepage and deterioration in the following areas: seals (of wheel and swing-arm bearings, fork and brakes), electric components (couplers, connectors, instruments, switches and lights), breather hoses and vents.**
 - **For motorcycles equipped with a windshield: Do not use strong cleaners or hard sponges as they will cause dulling or scratching. Some cleaning compounds for plastic may leave scratches on the windshield. Test the product on a small hidden part of the windshield to make sure that it does not leave any marks. If the windshield is scratched, use a quality plastic polishing compound after washing.**

MOTORCYCLE CARE AND STORAGE

After normal use

Remove dirt with warm water, a mild detergent, and a soft, clean sponge, and then rinse thoroughly with clean water. Use a toothbrush or bottlebrush for hard-to-reach areas. Stubborn dirt and insects will come off more easily if the area is covered with a wet cloth for a few minutes before cleaning.

After riding in the rain, near the sea or on salt-sprayed roads

Since sea salt or salt sprayed on roads during winter are extremely corrosive in combination with water, carry out the following steps after each ride in the rain, near the sea or on salt-sprayed roads.

NOTE:

Salt sprayed on roads in the winter may remain well into spring.

1. Clean the motorcycle with cold water and a mild detergent, after the engine has cooled down.

ECA10790

CAUTION:

Do not use warm water since it increases the corrosive action of the salt.

2. After drying the motorcycle, apply a corrosion protection spray on all metal, including chrome- and nickel-plated, surfaces to prevent corrosion.

After cleaning

1. Dry the motorcycle with a chamois or an absorbing cloth.
2. Use a chrome polish to shine chrome, aluminum and stainless-steel parts, including the exhaust system. (Even the thermally induced discoloring of stainless-steel exhaust systems can be removed through polishing.)
3. To prevent corrosion, it is recommended to apply a corrosion protection spray on all metal, including chrome- and nickel-plated, surfaces.
4. Use spray oil as a universal cleaner to remove any remaining dirt.

5. Touch up minor paint damage caused by stones, etc.
6. Wax all painted surfaces.
7. Let the motorcycle dry completely before storing or covering it.

EWA11130

WARNING

- **Make sure that there is no oil or wax on the brakes or tires.**
- **If necessary, clean the brake discs and brake linings with a regular brake disc cleaner or acetone, and wash the tires with warm water and a mild detergent. Before riding at higher speeds, test the motorcycle's braking performance and cornering behavior.**

ECA10800

CAUTION:

- **Apply spray oil and wax sparingly and make sure to wipe off any excess.**
- **Never apply oil or wax to any rubber and plastic parts, but treat them with a suitable care product.**

MOTORCYCLE CARE AND STORAGE

- **Avoid using abrasive polishing compounds as they will wear away the paint.**

NOTE: _____
Consult a Yamaha dealer for advice on what products to use.

Storage

EAU26240

Short-term

Always store your motorcycle in a cool, dry place and, if necessary, protect it against dust with a porous cover.

ECA10810

CAUTION:

- **Storing the motorcycle in a poorly ventilated room or covering it with a tarp, while it is still wet, will allow water and humidity to seep in and cause rust.**
- **To prevent corrosion, avoid damp cellars, stables (because of the presence of ammonia) and areas where strong chemicals are stored.**

Long-term

Before storing your motorcycle for several months:

1. Follow all the instructions in the "Care" section of this chapter.
2. Fill up the fuel tank and add fuel stabilizer (if available) to prevent the fuel tank from rusting and the fuel from deteriorating.

3. Perform the following steps to protect the cylinders, piston rings, etc. from corrosion.
 - a. Remove the spark plug caps and spark plugs.
 - b. Pour a teaspoonful of engine oil into each spark plug bore.
 - c. Install the spark plug caps onto the spark plugs, and then place the spark plugs on the cylinder head so that the electrodes are grounded. (This will limit sparking during the next step.)
 - d. Turn the engine over several times with the starter. (This will coat the cylinder walls with oil.)
 - e. Remove the spark plug caps from the spark plugs, and then install the spark plugs and the spark plug caps.

EWA10950

WARNING

To prevent damage or injury from sparking, make sure to ground the spark plug electrodes while turning the engine over.

MOTORCYCLE CARE AND STORAGE

4. Lubricate all control cables and the pivoting points of all levers and pedals as well as of the side-stand/centerstand.
5. Check and, if necessary, correct the tire air pressure, and then lift the motorcycle so that both of its wheels are off the ground. Alternatively, turn the wheels a little every month in order to prevent the tires from becoming degraded in one spot.
6. Cover the muffler outlets with plastic bags to prevent moisture from entering them.
7. Remove the battery and fully charge it. Store it in a cool, dry place and charge it once a month. Do not store the battery in an excessively cold or warm place (less than 0 °C [30 °F] or more than 30 °C [90 °F]). For more information on storing the battery, see page 6-30.

NOTE: _____

Make any necessary repairs before storing the motorcycle.

Dimensions:

- Overall length:
2195 mm (86.4 in)
- Overall width:
760 mm (29.9 in)
- Overall height:
1435 mm (56.5 in)
- Seat height:
805 mm (31.7 in)
- Wheelbase:
1515 mm (59.6 in)
- Ground clearance:
135 mm (5.31 in)
- Minimum turning radius:
3100 mm (122.0 in)

Weight:

- With oil and fuel:
FJR1300 275.0 kg (606 lb) (U49)
FJR1300 276.0 kg (608 lb) (CAL)
FJR1300A 282.0 kg (622 lb) (U49)
FJR1300A 283.0 kg (624 lb) (CAL)

Engine:

- Engine type:
Liquid cooled 4-stroke, DOHC
- Cylinder arrangement:
Forward-inclined parallel 4-cylinder
- Displacement:
1298.0 cm³ (79.20 cu.in)
- Bore × stroke:
79.0 × 66.2 mm (3.11 × 2.61 in)
- Compression ratio:
10.80 :1
- Starting system:
Electric starter

Lubrication system:

Wet sump

Engine oil:

- Type:
YAMALUBE 4 (20W40) or SAE20W40
- Recommended engine oil grade:
API service SE, SF, SG type or higher
- Engine oil quantity:
Without oil filter cartridge replacement:
3.80 L (4.02 US qt) (3.34 Imp.qt)
With oil filter cartridge replacement:
4.00 L (4.23 US qt) (3.52 Imp.qt)

Final gear oil:

- Type:
Shaft drive gear oil
- Quantity:
0.20 L (0.21 US qt) (0.18 Imp.qt)

Cooling system:

- Coolant reservoir capacity (up to the maximum level mark):
0.25 L (0.26 US qt) (0.22 Imp.qt)
- Radiator capacity (including all routes):
3.20 L (3.38 US qt) (2.82 Imp.qt)

Air filter:

- Air filter element:
Dry element

Fuel:

- Recommended fuel:
Unleaded gasoline only
- Fuel tank capacity:
25.0 L (6.61 US gal) (5.50 Imp.gal)
- Fuel reserve amount:
5.0 L (1.32 US gal) (1.10 Imp.gal)

Electronic fuel injection:

- Manufacturer:
NIPPON INJECTOR
- Model:
INP-732/4

Spark plug(s):

- Manufacturer/model:
NGK/CR8E
- Manufacturer/model:
DENSO/U24ESR-N
- Spark plug gap:
0.7–0.8 mm (0.028–0.031 in)

Clutch:

- Clutch type:
Wet, multiple-disc

Transmission:

- Primary reduction system:
Helical gear
- Primary reduction ratio:
75/48 (1.563)
- Secondary reduction system:
Shaft drive
- Secondary reduction ratio:
35/36 × 21/27 × 33/9 (2.773)
- Transmission type:
Constant mesh 5-speed
- Operation:
Left foot operation
- Gear ratio:
1st:
43/17 (2.529)
2nd:
39/22 (1.773)

SPECIFICATIONS

3rd:
31/23 (1.348)
4th:
28/26 (1.077)
5th:
26/28 (0.929)

Chassis:

Frame type:
Diamond
Caster angle:
26.00 °
Trail:
109.0 mm (4.29 in)

Front tire:

Type:
Tubeless
Size:
120/70 ZR17M/C (58W)
Manufacturer/model:
METZELER/MEZ4J FRONT
Manufacturer/model:
BRIDGESTONE/BT020F N

Rear tire:

Type:
Tubeless
Size:
180/55 ZR17M/C (73W)
Manufacturer/model:
METZELER/MEZ4J
Manufacturer/model:
BRIDGESTONE/BT020R N

Loading:

Maximum load:
FJR1300 200 kg (441 lb) (CAL)
FJR1300 201 kg (443 lb) (U49)
FJR1300A 193 kg (425 lb) (CAL)
FJR1300A 194 kg (428 lb) (U49)
(Total weight of rider, passenger, cargo and accessories)

Tire air pressure (measured on cold tires):

Loading condition:
0–90 kg (0–198 lb)
Front:
250 kPa (36 psi) (2.50 kgf/cm²)
Rear:
250 kPa (36 psi) (2.50 kgf/cm²)
Loading condition:
FJR1300 90–200 kg (198–441 lb) (CAL)
FJR1300 90–201 kg (198–443 lb) (U49)
FJR1300A 90–193 kg (198–425 lb) (CAL)
FJR1300A 90–194 kg (198–428 lb) (U49)
Front:
250 kPa (36 psi) (2.50 kgf/cm²)
Rear:
290 kPa (42 psi) (2.90 kgf/cm²)
High-speed riding:
Front:
250 kPa (36 psi) (2.50 kgf/cm²)
Rear:
250 kPa (36 psi) (2.50 kgf/cm²)

Front wheel:

Wheel type:
Cast wheel

Rim size:
17M/C x MT3.50

Rear wheel:

Wheel type:
Cast wheel
Rim size:
17M/C x MT5.50

Front brake:

Type:
Dual disc brake
Operation:
Right hand operation
Recommended fluid:
DOT 4

Rear brake:

Type:
Single disc brake
Operation:
Right foot operation
Recommended fluid:
DOT 4

Front suspension:

Type:
Telescopic fork
Spring/shock absorber type:
Coil spring/oil damper
Wheel travel:
135.0 mm (5.31 in)

Rear suspension:

Type:
Swingarm (link suspension)
Spring/shock absorber type:
Coil spring/gas-oil damper

Wheel travel:
125.0 mm (4.92 in)

Electrical system:

Ignition system:
Transistorized coil ignition (digital)

Charging system:
A.C. magneto

Battery:

Model:
GT14B-4

Voltage, capacity:
12 V, 12.0 Ah

Headlight:

Bulb type:
Halogen bulb

Bulb voltage, wattage x quantity:

Headlight:
12 V, 60 W/55.0 W × 2

Tail/brake light:
12 V, 5.0/21.0 W × 2

Front turn signal/position light:
12 V, 21 W/5.0 W × 2

Rear turn signal light:
12 V, 21.0 W × 2

Meter lighting:
14 V, 1.1 W × 4

Neutral indicator light:
14 V, 1.1 W × 1

High beam indicator light:
14 V, 1.1 W × 1

Oil level warning light:
14 V, 1.1 W × 1

Turn signal indicator light:
14 V, 2.0 W × 2

Engine trouble warning light:
14 V, 1.1 W × 1

ABS warning light:
FJR1300A 14 V, 1.1 W × 1

Fuses:

Main fuse:
50.0 A

Headlight fuse:
25.0 A

Signaling system fuse:
15.0 A

Ignition fuse:
10.0 A

Radiator fan fuse:
15.0 A

Hazard fuse:
7.5 A

Electronic fuel injection fuse:
15.0 A

ABS control unit fuse:
FJR1300A 7.5 A

ABS motor fuse:
FJR1300A 30.0 A

Tail/position light fuse:
10.0 A

Backup fuse:
10.0 A

Windshield motor fuse:
2.0 A

CONSUMER INFORMATION

EAU26351

Identification numbers

Record the key identification number, vehicle identification number and model label information in the spaces provided below for assistance when ordering spare parts from a Yamaha dealer or for reference in case the vehicle is stolen.

KEY IDENTIFICATION NUMBER:

VEHICLE IDENTIFICATION NUMBER:

MODEL LABEL INFORMATION:

Key identification number

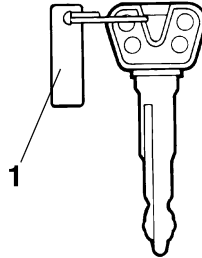

1. Key identification number

The key identification number is stamped into the key tag. Record this number in the space provided and use it for reference when ordering a new key.

EAU26381

Vehicle identification number

EAU26400

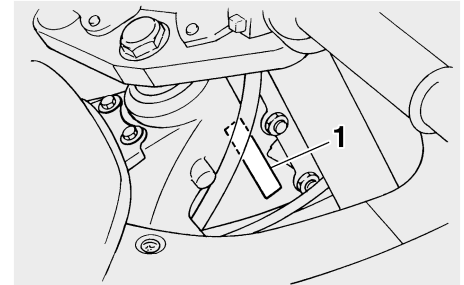

1. Vehicle identification number

The vehicle identification number is stamped into the steering head pipe. Record this number in the space provided.

NOTE: _____

The vehicle identification number is used to identify your motorcycle and may be used to register your motorcycle with the licensing authority in your area.

EAU26470

Model label

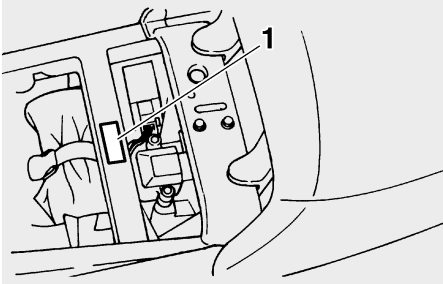

1. Model label

The model label is affixed to the frame under the rider seat. (See page 3-11.) Record the information on this label in the space provided. This information will be needed when ordering spare parts from a Yamaha dealer.

CONSUMER INFORMATION

EAU26550

Reporting safety defects

If you believe that your vehicle has a defect which could cause a crash or could cause injury or death, you should immediately inform the National Highway Traffic Safety Administration (NHTSA) in addition to notifying Yamaha Motor Corporation, U.S.A. If NHTSA receives similar complaints, it may open an investigation, and if it finds that a safety defect exists in a group of vehicles, it may order a recall and remedy campaign. However, NHTSA cannot become involved in individual problems between you, your dealer, or Yamaha Motor Corporation, U.S.A.

To contact NHTSA, you may either call the Auto Safety Hotline toll-free at 1-800-424-9393 (or 366-0123 in Washington, D.C. area) or write to: NHTSA, U.S. Department of Transportation, Washington, D.C. 20590. You can also obtain other information about motor vehicle safety from the Hotline.

Motorcycle noise regulation

TAMPERING WITH NOISE CONTROL SYSTEM PROHIBITED:

Federal law prohibits the following acts or the causing thereof: (1) The removal or rendering inoperative by any person other than for purposes of maintenance, repair, or replacement of any device or element of design incorporated into any new vehicle for the purpose of noise control prior to its sale or delivery to the ultimate purchaser or while it is in use or (2) the use of the vehicle after such device or element of design has been removed or rendered inoperative by any person.

“AMONG THOSE ACTS PRESUMED TO CONSTITUTE TAMPERING ARE THE ACTS LISTED BELOW”.

These acts include tampering with the following systems; i.e., modification, removal, etc.

Exhaust system

- Muffler
- Exhaust pipe
- Silencer

Intake system

- Air cleaner case
- Air cleaner element
- Intake duct

CONSUMER INFORMATION

EAU26631

Maintenance record

Copies of work orders and/or receipts for parts purchased and installed on your motorcycle will be required to document that maintenance has been completed in accordance with the emissions warranty. The chart below is printed only as a reminder that maintenance work is required. It is not acceptable proof of maintenance work.

| Maintenance interval | Date of service | Mileage | Servicing dealer name and address | Remarks |
|--|-----------------|---------|-----------------------------------|---------|
| 600 mi (1000 km) or 1 month | | | | |
| 4000 mi (7000 km) or 6 months | | | | |
| 8000 mi (13000 km) or 12 months | | | | |
| 12000 mi (19000 km) or 18 months | | | | |
| 16000 mi (25000 km) or 24 months | | | | |
| 20000 mi (31000 km) or 30 months | | | | |
| 24000 mi (37000 km) or 36 months | | | | |
| 28000 mi (43000 km) or 42 months | | | | |
| 32000 mi (49000 km) or 48 months | | | | |

CONSUMER INFORMATION

| Maintenance interval | Date of service | Mileage | Servicing dealer name and address | Remarks |
|--|-----------------|---------|-----------------------------------|---------|
| 36000 mi (55000 km) or 54 months | | | | |
| 40000 mi (61000 km) or 60 months | | | | |

CONSUMER INFORMATION

EAU26661

YAMAHA MOTOR CORPORATION, U.S.A. STREET AND ENDURO MOTORCYCLE LIMITED WARRANTY

Yamaha Motor Corporation, U.S.A. hereby warrants each new model Yamaha motorcycle will be free from defects in material and workmanship for the period of time stated herein, subject to certain stated limitations.

THE PERIOD OF WARRANTY for Yamaha motorcycles originally equipped with headlight, stoplight, and turn signals shall be one (1) year from the date of purchase, with no mileage limitation.

MODELS EXCLUDED FROM WARRANTY include those used for non-Yamaha-authorized renting, leasing, or other commercial purposes, and TZ models.

DURING THE PERIOD OF WARRANTY any authorized Yamaha motorcycle dealer will, free of charge, repair or replace any part adjudged defective by Yamaha due to faulty workmanship or material from the factory. Parts used in warranty repairs will be warranted for the balance of the product's warranty period. All parts replaced under warranty become property of Yamaha Motor Corp. U.S.A.

GENERAL EXCLUSIONS from this warranty shall include any failures caused by:

- a. Competition or racing use.
- b. Installation of parts or accessories that are not qualitatively equivalent to genuine Yamaha parts.
- c. Abnormal strain, neglect, or abuse.
- d. Lack of proper maintenance.
- e. Accident or collision damage.
- f. Modification to original parts.

SPECIFIC EXCLUSIONS from this warranty shall include parts replaced due to normal wear or routine maintenance.

THE CUSTOMER'S RESPONSIBILITY under this warranty shall be to:

1. Operate and maintain the motorcycle as specified in the appropriate Owner's Manual, and
2. Give notice to an authorized Yamaha motorcycle dealer of any and all apparent defects within ten (10) days after discovery, and make the machine available at that time for inspection and repairs at such dealer's place of business.

WARRANTY TRANSFER: To transfer the warranty from the original purchaser to any subsequent purchaser, it is imperative that the machine be inspected and registered for warranty by an authorized Yamaha motorcycle dealer. In order for this warranty to remain in effect, this inspection and registration must take place within ten (10) days after transfer. An inspection and registration fee will be charged for this service.

EMISSIONS CONTROL SYSTEM WARRANTY

Yamaha Motor Corporation, U.S.A. also warrants to the ultimate purchaser and each subsequent purchaser of each Yamaha motorcycle covered by this warranty with a displacement of 50cc or greater, that the vehicle is designed, built, and equipped so as to conform at the time of sale with all U.S. emissions standards applicable at the time of manufacture and that it is free from defects in materials and workmanship which would cause it not to meet these standards within the periods listed immediately below. Failure other than those resulting from defects in material or workmanship which arise solely as a result of owner abuse and / or lack of proper maintenance are not covered by this warranty.

| ENGINE DISPLACEMENT | PERIOD |
|---------------------|---|
| 50cc to 169cc | 12,000 km (7,465 miles) or five years, whichever occurs first |
| 170cc to 279cc | 18,000 km (11,185 miles) or five years, whichever occurs first |
| 280cc or over | 30,000 km (18,641 miles) or five years, whichever occurs first |

YAMAHA MOTOR CORPORATION, U.S.A. MAKES NO OTHER WARRANTY OF ANY KIND, EXPRESSED OR IMPLIED. ALL IMPLIED WARRANTIES OF MERCHANTABILITY AND FITNESS FOR A PARTICULAR PURPOSE WHICH EXCEED THE OBLIGATIONS AND TIME LIMITS STATED IN THIS WARRANTY ARE HEREBY DISCLAIMED BY YAMAHA MOTOR CORPORATION, U.S.A. AND EXCLUDED FROM THIS WARRANTY.

SOME STATES DO NOT ALLOW LIMITATIONS ON HOW LONG AN IMPLIED WARRANTY LASTS, SO THE ABOVE LIMITATION MAY NOT APPLY TO YOU. ALSO EXCLUDED FROM THIS WARRANTY ARE ANY INCIDENTAL OR CONSEQUENTIAL DAMAGES INCLUDING LOSS OF USE. SOME STATES DO NOT ALLOW THE EXCLUSION OR LIMITATION OF INCIDENTAL OR CONSEQUENTIAL DAMAGES, SO THE ABOVE EXCLUSION MAY NOT APPLY TO YOU.

THIS WARRANTY GIVES YOU SPECIFIC LEGAL RIGHTS, AND YOU MAY ALSO HAVE OTHER RIGHTS WHICH VARY FROM STATE TO STATE.

YAMAHA MOTOR CORPORATION, U.S.A.
P.O. Box 6555
Cypress, California 90630

WARRANTY QUESTIONS AND ANSWERS

- Q. What costs are my responsibility during the warranty period?
- A. The customer's responsibility includes all costs of normal maintenance services, non-warranty repairs, accident and collision damages, and oil, oil filters, air filters, spark plugs, and brake shoes.
- Q. What are some examples of "abnormal" strain, neglect, or abuse?
- A. These terms are general and overlap each other in areas. Specific examples include: Running the machine out of oil, sustained high-rpm, full-throttle, operating the machine with a broken or damaged part which causes another part to fail, damage or failure due to improper or careless transportation and or tie down. If you have any specific questions on operation or maintenance, please contact your dealer for advice.
- Q. Does the warranty cover incidental costs such as towing or transportation due to a failure?
- A. No. The warranty is limited to repair of the machine itself.
- Q. May I perform any or all of the recommended maintenance shown in the Owner's Manual instead of having the dealer do them?
- A. Yes, if you are a qualified mechanic and follow the procedures specified in the Owner's and Service Manual. We do recommend, however, that items requiring special tools or equipment be done by Yamaha Motorcycle dealer.
- Q. Will the warranty be void or cancelled if I do not operate or maintain my new motorcycle exactly as specified in the Owner's Manual?
- A. No. The warranty on a new motorcycle cannot be "voided" or "cancelled." **However, if a particular failure is caused by operation or maintenance other than as shown in the Owner's Manual, that failure may not be covered under warranty.**
- Q. What responsibility does my dealer have under this warranty?
- A. Each Yamaha Motorcycle dealer is expected to:
1. Completely set up every new machine before sale.
 2. Explain the operation, maintenance, and warranty requirements to your satisfaction at the time of sale, and upon your request at any later date.
 3. Each Yamaha Motorcycle dealer is held responsible for his setup, service and warranty repair work.
- Q. Is the warranty transferable to second owners?
- A. Yes. The remainder of the existing warranty can be transferred upon request. The unit has to be inspected and re-registered by an authorized Yamaha Motorcycle dealer for the policy to remain effective.

CUSTOMER SERVICE

If your machine requires warranty service, you must take it to any authorized Yamaha Motorcycle dealer within the continental United States. Be sure to bring your warranty registration card or other valid proof of the original date of purchase. If a question or problem arises regarding warranty, first contact the owner of the dealership. Since all warranty matters are handled at the dealer level, this person is in the best position to help you. If you are still not satisfied and require additional assistance, please write:

YAMAHA MOTOR CORPORATION U.S.A.
CUSTOMER RELATIONS DEPARTMENT
P.O. Box 6555
Cypress, California 90630

When contacting Yamaha Motor Corporation, U.S.A. don't forget to include any important information such as names, addresses, model, V.I.N. (frame number), dates, and receipts.

CHANGE OF ADDRESS

The federal government requires each manufacturer of a motor vehicle to maintain a complete, up-to-date list of all first purchasers against the possibility of a safety-related defect and recall. This list is compiled from the purchase registrations sent to Yamaha Motor Corporation, U.S.A. by the selling dealer at the time of your purchase.

If you should move after you have purchased your new motorcycle, please advise us of your new address by sending a postcard listing your motorcycle model name, V.I.N. (frame number), dealer number (or dealer's name) as it is shown on your warranty card, your name and new mailing address. Mail to:

YAMAHA MOTOR CORPORATION, U.S.A.
P.O. Box 6555
Cypress, California 90630
Attention: Warranty Department

This will ensure that Yamaha Motor Corporation, U.S.A. has an up-to-date registration record in accordance with federal law.

YAMAHA EXTENDED SERVICE (Y.E.S.)

Keep your Yamaha protected even after your warranty expires with genuine Yamaha Extended Service (Y.E.S.).

- Y.E.S. is designed and administered by Yamaha Motor Corporation to provide maximum owner satisfaction. You get uninterrupted factory-backed coverage for extra peace of mind.
- Y.E.S. is flexible. You choose the plan that's right for you: 12 months, 24 months, 36 months or, on certain models, even 48 months beyond your warranty period.
- Y.E.S. is designed and administered by the same Yamaha people who handle your warranty – and it shows in the comprehensive coverage benefits. There are no mileage limitations. Coverage isn't limited to “moving parts” or the “drive train” like many other plans. And Y.E.S. covers manufacturing defects just like the warranty. See the sample contract at your Yamaha dealer to see how comforting uninterrupted factory-backed protection can be.
- You don't have to pay anything for covered repairs. There's no deductible to pay, and repairs aren't “pro-rated.” You don't have any “out-of-pocket” expenses for covered repairs.
- In addition, Travel and Recreation Interruption Protection (TRIP) is included at no extra cost. TRIP gives you up to \$150 reimbursement per occurrence for any reasonable expenses you incur because your Yamaha needs covered service: replacement vehicle rental, emergency towing, phone calls, even food and lodging when you are away from home. This superb coverage goes into effect when you purchase Y.E.S., so it applies to any warranty repairs as well as covered repairs during your entire Y.E.S. plan period.
- Y.E.S. coverage is honored at any authorized Yamaha dealer nationwide.
- Y.E.S. coverage is transferable to a new owner if you sell or trade-in. That can make your Yamaha much more valuable!

This excellent Y.E.S. plan coverage is only available to Yamaha owners like you, and only while your Yamaha is still within the Yamaha Limited Warranty period. So visit your authorized Yamaha dealer to get all the facts. He can show you how easy it is to protect your investment with Yamaha Extended Service.

CONSUMER INFORMATION

We urge you to act now. You'll get the excellent benefits of TRIP coverage right away, and you'll rest easy knowing you'll have strong factory-backed protection even after your Yamaha Limited Warranty expires.

A special note:

If visiting your dealer isn't convenient, contact Yamaha with your Primary ID number (your frame number). We'll be happy to help you get the Y.E.S. coverage you need.

Yamaha Service Marketing

P.O. Box 6555

Cypress, CA 90630

1-(866)-YES-EXTD (1-866-937-3983)

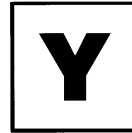

YAMAHA



EXTENDED

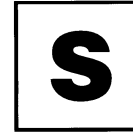

SERVICE

INDEX

- A**
ABS (for ABS models) 3-8
ABS warning light (for ABS models) 3-2
Accessories and replacement parts 6-22
Accessory box 3-12
Air filter element, cleaning 6-17
- B**
Battery 6-30
Brake and clutch fluid levels,
checking 6-24
Brake and clutch fluids, changing 6-25
Brake and clutch levers,
checking and lubricating 6-27
Brake and shift pedals,
checking and lubricating 6-26
Brake lever 3-8
Brake pedal 3-8
- C**
Cables, checking and lubricating 6-26
Canister (for California only) 6-11
Care 7-1
Catalytic converter 3-11
Centerstand and sidestand,
checking and lubricating 6-28
Clutch lever 3-7
Clutch lever free play 6-23
Coolant 6-15
- D**
Dimmer switch 3-5
Display, multi-function 3-4
- E**
Engine break-in 5-3
Engine oil and oil filter cartridge 6-11
Engine stop switch 3-6
- Engine trouble warning light 3-2
- F**
Final gear oil 6-14
Front and rear brake pads, checking 6-23
Front fork, adjusting 3-13
Front fork, checking 6-28
Fuel 3-10
Fuel tank cap 3-9
Fuses, replacing 6-31
- H**
Handlebar switches 3-5
Hazard switch 3-6
Headlight bulb, replacing 6-33
High beam indicator light 3-2
Horn switch 3-6
- I**
Identification numbers 9-1
Ignition circuit cut-off system 3-17
Indicator and warning lights 3-2
- K**
Key identification number 9-1
- L**
Labels, location of 1-5
Locks for optional side cases and
travel trunk 3-16
- M**
Main switch/steering lock 3-1
Maintenance and lubrication, periodic 6-4
Maintenance, emission control system... 6-3
Maintenance, periodic 6-1
Maintenance record 9-5
Model label 9-2
- N**
Neutral indicator light 3-2
- Noise regulation 9-4
- O**
Oil level warning light 3-2
- P**
Panels, removing and installing 6-8
Parking 5-4
Part locations 2-1
Pre-operation check list 4-2
- R**
Rear brake light switch, adjusting 6-23
Rear suspension, lubricating 6-28
- S**
Safety defects, reporting 9-3
Safety information 1-1
Seats 3-11
Shifting 5-2
Shift pedal 3-7
Shock absorber assembly, adjusting 3-15
Sidestand 3-16
Spark plugs, checking 6-10
Specifications 8-1
Speedometer 3-3
Starting the engine 5-1
Start switch 3-6
Steering, checking 6-29
Storage 7-3
Storage compartment 3-12
- T**
Tachometer 3-3
Throttle cable free play, adjusting 6-18
Throttle grip and cable,
checking and lubricating 6-26
Tires 6-19
Tool kit 6-1

| | |
|--|------|
| Troubleshooting | 6-35 |
| Troubleshooting charts | 6-36 |
| Turn signal indicator lights | 3-2 |
| Turn signal light or tail/brake light bulb, replacing | 6-34 |
| Turn signal switch | 3-5 |

V

| | |
|-------------------------------------|------|
| Valve clearance, adjusting | 6-19 |
| Vehicle identification number | 9-1 |

W

| | |
|--|------|
| Warranty, extended | 9-9 |
| Warranty, limited | 9-7 |
| Wheel bearings, checking | 6-30 |
| Wheels | 6-22 |
| Windshield position adjusting switch | 3-5 |

PROTECT YOUR INVESTMENT

Use *Genuine YAMAHA* Parts And Accessories

See your Authorized YAMAHA Dealer for a Genuine YAMAHA Service Manual.



YAMAHA MOTOR CO., LTD.

PRINTED ON RECYCLED PAPER

Download from www.somanuals.com. All Manuals Search And Download.

PRINTED IN JAPAN
2004.05-2.1×1 CR
(E)

Free Manuals Download Website

<http://myh66.com>

<http://usermanuals.us>

<http://www.somanuals.com>

<http://www.4manuals.cc>

<http://www.manual-lib.com>

<http://www.404manual.com>

<http://www.luxmanual.com>

<http://aubethermostatmanual.com>

Golf course search by state

<http://golfingnear.com>

Email search by domain

<http://emailbydomain.com>

Auto manuals search

<http://auto.somanuals.com>

TV manuals search

<http://tv.somanuals.com>