



**OWNER'S MANUAL**

**FJR**

**FJR13AV(C)**

**LIT-11626-19-83**

Download from [www.somanuals.com](http://www.somanuals.com). All Manuals Search And Download.

**3P6-28199-10**

EAU10041

 **WARNING**

**The engine exhaust from this product contains chemicals known to the State of California to cause cancer, birth defects or other reproductive harm.**

YAMAHA

LIT-CALIF-65-01

Congratulations on your purchase of the Yamaha FJR13AV(C). This model is the result of Yamaha's vast experience in the production of fine sporting, touring, and pacesetting racing machines. It represents the high degree of craftsmanship and reliability that have made Yamaha a leader in these fields.



This manual will give you an understanding of the operation, inspection, and basic maintenance of this motorcycle. If you have any questions concerning the operation or maintenance of your motorcycle, please consult a Yamaha dealer.

The design and manufacture of this Yamaha motorcycle fully comply with the emissions standards for clean air applicable at the date of manufacture. Yamaha has met these standards without reducing the performance or economy of operation of the motorcycle. To maintain these high standards, it is important that you and your Yamaha dealer pay close attention to the recommended maintenance schedules and operating instructions contained within this manual.

# IMPORTANT MANUAL INFORMATION

EAU10131

Particularly important information is distinguished in this manual by the following notations:

	<b>The Safety Alert Symbol means ATTENTION! BECOME ALERT! YOUR SAFETY IS INVOLVED!</b>
	<b>Failure to follow WARNING instructions could result in severe injury or death to the motorcycle operator, a bystander or a person inspecting or repairing the motorcycle.</b>
<b>CAUTION:</b>	<b>A CAUTION indicates special precautions that must be taken to avoid damage to the motorcycle.</b>
<b>NOTE:</b>	<b>A NOTE provides key information to make procedures easier or clearer.</b>

## NOTE:

- This manual should be considered a permanent part of this motorcycle and should remain with it even if the motorcycle is subsequently sold.
- Yamaha continually seeks advancements in product design and quality. Therefore, while this manual contains the most current product information available at the time of printing, there may be minor discrepancies between your motorcycle and this manual. If you have any questions concerning this manual, please consult your Yamaha dealer.

EWA10010

## **WARNING**

**PLEASE READ THIS MANUAL AND THE “YOU AND YOUR MOTORCYCLE: RIDING TIPS” BOOKLET CAREFULLY AND COMPLETELY BEFORE OPERATING THIS MOTORCYCLE. DO NOT ATTEMPT TO OPERATE THIS MOTORCYCLE UNTIL YOU HAVE ATTAINED ADEQUATE KNOWLEDGE OF ITS CONTROLS AND OPERATING FEATURES**

# **IMPORTANT MANUAL INFORMATION**

---

---

**AND UNTIL YOU HAVE BEEN TRAINED IN SAFE AND PROPER RIDING TECHNIQUES. REGULAR INSPECTIONS AND CAREFUL MAINTENANCE, ALONG WITH GOOD RIDING SKILLS, WILL ENSURE THAT YOU SAFELY ENJOY THE CAPABILITIES AND THE RELIABILITY OF THIS MOTORCYCLE.**

---

\*Product and specifications are subject to change without notice.

# IMPORTANT MANUAL INFORMATION

---

---

EAU10192

AFFIX DEALER  
LABEL HERE

**FJR13AV(C)  
OWNER'S MANUAL**  
©2005 by Yamaha Motor Corporation, U.S.A.  
1st edition, December 2005  
All rights reserved.  
Any reprinting or unauthorized use  
without the written permission of  
Yamaha Motor Corporation, U.S.A.  
is expressly prohibited.  
Printed in Japan.  
P/N LIT-11626-19-83

# TABLE OF CONTENTS

<b>SAFETY INFORMATION</b> .....	1-1	Opening and closing the cowlings .....	3-20	Engine oil and oil filter cartridge ...	6-13
Location of important labels .....	1-5	Rear view mirrors .....	3-21	Final gear oil .....	6-15
<b>DESCRIPTION</b> .....	2-1	Adjusting the front fork .....	3-21	Coolant .....	6-17
Left view .....	2-1	Adjusting the shock absorber assembly .....	3-23	Cleaning the air filter element .....	6-18
Right view .....	2-2	Sidestand .....	3-24	Checking the throttle cable free play .....	6-20
Controls and instruments .....	2-3	Ignition circuit cut-off system .....	3-25	Valve clearance .....	6-20
<b>INSTRUMENT AND CONTROL</b>		Auxiliary DC jack .....	3-27	Tires .....	6-20
<b>FUNCTIONS</b> .....	3-1	<b>PRE-OPERATION CHECKS</b> .....	4-1	Cast wheels .....	6-23
Main switch/steering lock .....	3-1	Pre-operation check list .....	4-2	Accessories and replacement parts .....	6-23
Indicator and warning lights .....	3-2	<b>OPERATION AND IMPORTANT</b>		Clutch lever .....	6-24
Speedometer .....	3-3	<b>RIDING POINTS</b> .....	5-1	Adjusting the rear brake light switch .....	6-24
Tachometer .....	3-3	Starting the engine .....	5-1	Checking the front and rear brake pads .....	6-25
Multi-function display .....	3-4	Shifting .....	5-2	Checking the brake and clutch fluid levels .....	6-25
Handlebar switches .....	3-8	Engine break-in .....	5-3	Changing the brake and clutch fluids .....	6-27
Clutch lever .....	3-10	Parking .....	5-4	Checking and lubricating the cables .....	6-27
Brake lever .....	3-11	<b>PERIODIC MAINTENANCE AND</b>		Checking and lubricating the throttle grip and cable .....	6-27
Brake pedal .....	3-11	<b>MINOR REPAIR</b> .....	6-1	Checking and lubricating the brake and shift pedals .....	6-28
ABS .....	3-12	PERIODIC MAINTENANCE .....	6-1	Checking and lubricating the brake and clutch levers .....	6-28
Fuel tank cap .....	3-12	Owner's tool kit .....	6-1	Checking and lubricating the centerstand and sidestand .....	6-29
Fuel .....	3-13	Periodic maintenance chart for the emission control system .....	6-3	Lubricating the swingarm pivots ...	6-29
Catalytic converter .....	3-14	General maintenance and lubrication chart .....	6-4		
Seats .....	3-14	Removing and installing panels .....	6-8		
Adjusting the rider seat height .....	3-16	Checking the spark plugs .....	6-11		
Storage compartments .....	3-18	Canister (for California only) .....	6-12		
Accessory box .....	3-18				
Adjusting the headlight beams .....	3-19				
Handlebar position .....	3-19				

# TABLE OF CONTENTS

---

Lubricating the rear suspension	...6-30
Checking the front fork	.....6-30
Checking the steering	.....6-31
Checking the wheel bearings	.....6-31
Battery	.....6-32
Replacing the fuses	.....6-33
Replacing a headlight bulb	.....6-34
Front turn signal light	.....6-36
Replacing a rear turn signal light bulb or a tail/brake light bulb	.....6-36
Replacing the license plate light bulb	.....6-37
Troubleshooting	.....6-37
Troubleshooting charts	.....6-38

## **MOTORCYCLE CARE AND**

<b>STORAGE</b>	.....7-1
Care	.....7-1
Storage	.....7-3

## **SPECIFICATIONS** | | | |-----------------------------|----------| | <b>CONSUMER INFORMATION</b> | .....9-1 | | Identification numbers | .....9-1 | | Reporting safety defects | .....9-3 | | Motorcycle noise regulation | .....9-4 | | Maintenance record | .....9-5 | | | | |--------------------------------|----------| | <b>YAMAHA MOTOR</b> | | | <b>CORPORATION, U.S.A.</b> | | | <b>STREET AND ENDURO</b> | | | <b>MOTORCYCLE LIMITED</b> | | | <b>WARRANTY</b> | .....9-7 | | <b>YAMAHA EXTENDED SERVICE</b> | | | <b>(Y.E.S.)</b> | .....9-9 | Download from [www.Somanuals.com](http://www.Somanuals.com). All Manuals Search And Download.



EAU10281

MOTORCYCLES ARE SINGLE TRACK VEHICLES. THEIR SAFE USE AND OPERATION ARE DEPENDENT UPON THE USE OF PROPER RIDING TECHNIQUES AS WELL AS THE EXPERTISE OF THE OPERATOR. EVERY OPERATOR SHOULD KNOW THE FOLLOWING REQUIREMENTS BEFORE RIDING THIS MOTORCYCLE.

HE OR SHE SHOULD:

- OBTAIN THOROUGH INSTRUCTIONS FROM A COMPETENT SOURCE ON ALL ASPECTS OF MOTORCYCLE OPERATION.
- OBSERVE THE WARNINGS AND MAINTENANCE REQUIREMENTS IN THE OWNER'S MANUAL.
- OBTAIN QUALIFIED TRAINING IN SAFE AND PROPER RIDING TECHNIQUES.
- OBTAIN PROFESSIONAL TECHNICAL SERVICE AS INDICATED BY THE OWNER'S MANUAL

AND/OR WHEN MADE NECESSARY BY MECHANICAL CONDITIONS.

### Safe riding

- Always make pre-operation checks. Careful checks may help prevent an accident.
- This motorcycle is designed to carry the operator and a passenger.
- The failure of motorists to detect and recognize motorcycles in traffic is the predominating cause of automobile/motorcycle accidents. Many accidents have been caused by an automobile driver who did not see the motorcycle. Making yourself conspicuous appears to be very effective in reducing the chance of this type of accident.

### Therefore:

- Wear a brightly colored jacket.
- Use extra caution when you are approaching and passing through intersections, since intersections are the most likely places for motorcycle accidents to occur.

- Ride where other motorists can see you. Avoid riding in another motorist's blind spot.
- Many accidents involve inexperienced operators. In fact, many operators who have been involved in accidents do not even have a current motorcycle license.
- Make sure that you are qualified and that you only lend your motorcycle to other qualified operators.
- Know your skills and limits. Staying within your limits may help you to avoid an accident.
- We recommend that you practice riding your motorcycle where there is no traffic until you have become thoroughly familiar with the motorcycle and all of its controls.
- Many accidents have been caused by error of the motorcycle operator. A typical error made by the operator is veering wide on a turn

# SAFETY INFORMATION

1

due to EXCESSIVE SPEED or undercornering (insufficient lean angle for the speed).

- Always obey the speed limit and never travel faster than warranted by road and traffic conditions.
- Always signal before turning or changing lanes. Make sure that other motorists can see you.
- The posture of the operator and passenger is important for proper control.
  - The operator should keep both hands on the handlebar and both feet on the operator footrests during operation to maintain control of the motorcycle.
  - The passenger should always hold onto the operator, the seat strap or grab bar, if equipped, with both hands and keep both feet on the passenger footrests.
  - Never carry a passenger unless he or she can firmly place both feet on the passenger footrests.
- Never ride under the influence of alcohol or other drugs.

- This motorcycle is designed for on-road use only. It is not suitable for off-road use.

## Protective apparel

The majority of fatalities from motorcycle accidents are the result of head injuries. The use of a safety helmet is the single most critical factor in the prevention or reduction of head injuries.

- Always wear an approved helmet.
- Wear a face shield or goggles. Wind in your unprotected eyes could contribute to an impairment of vision that could delay seeing a hazard.
- The use of a jacket, heavy boots, trousers, gloves, etc., is effective in preventing or reducing abrasions or lacerations.
- Never wear loose-fitting clothes, otherwise they could catch on the control levers, footrests, or wheels and cause injury or an accident.
- Never touch the engine or exhaust system during or after operation. They become very hot and can

cause burns. Always wear protective clothing that covers your legs, ankles, and feet.

- A passenger should also observe the above precautions.

## Modifications

Modifications made to this motorcycle not approved by Yamaha, or the removal of original equipment, may render the motorcycle unsafe for use and may cause severe personal injury. Modifications may also make your motorcycle illegal to use.

## Loading and accessories

Adding accessories or cargo to your motorcycle can adversely affect stability and handling if the weight distribution of the motorcycle is changed. To avoid the possibility of an accident, use extreme caution when adding cargo or accessories to your motorcycle. Use extra care when riding a motorcycle that has added cargo or accessories. Here are some general guidelines to follow if loading cargo or adding accessories to your motorcycle:

### Loading

The total weight of the operator, passenger, accessories and cargo must not exceed the maximum load limit.

**Maximum load:**

211 kg (465 lb) (CAL)

212 kg (467 lb) (U49)

When loading within this weight limit, keep the following in mind:

- Cargo and accessory weight should be kept as low and close to the motorcycle as possible. Make sure to distribute the weight as evenly as possible on both sides of the motorcycle to minimize imbalance or instability.
- Shifting weights can create a sudden imbalance. Make sure that accessories and cargo are securely attached to the motorcycle before riding. Check accessory mounts and cargo restraints frequently.
- Never attach any large or heavy items to the handlebar, front fork, or front fender. These items, including such cargo as sleeping

bags, duffel bags, or tents, can create unstable handling or a slow steering response.

### Accessories

Genuine Yamaha accessories have been specifically designed for use on this motorcycle. Since Yamaha cannot test all other accessories that may be available, you must personally be responsible for the proper selection, installation and use of non-Yamaha accessories. Use extreme caution when selecting and installing any accessories.

Keep the following guidelines in mind, as well as those provided under “Loading” when mounting accessories.

- Never install accessories or carry cargo that would impair the performance of your motorcycle. Carefully inspect the accessory before using it to make sure that it does not in any way reduce ground clearance or cornering clearance,

limit suspension travel, steering travel or control operation, or obscure lights or reflectors.

- Accessories fitted to the handlebar or the front fork area can create instability due to improper weight distribution or aerodynamic changes. If accessories are added to the handlebar or front fork area, they must be as lightweight as possible and should be kept to a minimum.
- Bulky or large accessories may seriously affect the stability of the motorcycle due to aerodynamic effects. Wind may attempt to lift the motorcycle, or the motorcycle may become unstable in cross winds. These accessories may also cause instability when passing or being passed by large vehicles.
- Certain accessories can displace the operator from his or her normal riding position. This improper position limits the freedom of movement of the opera-

# SAFETY INFORMATION

1

tor and may limit control ability, therefore, such accessories are not recommended.

- Use caution when adding electrical accessories. If electrical accessories exceed the capacity of the motorcycle's electrical system, an electric failure could result, which could cause a dangerous loss of lights or engine power.

## Gasoline and exhaust gas

- GASOLINE IS HIGHLY FLAMMABLE:
  - Always turn the engine off when refueling.
  - Take care not to spill any gasoline on the engine or exhaust system when refueling.
  - Never refuel while smoking or in the vicinity of an open flame.
- Never start the engine or let it run for any length of time in a closed area. The exhaust fumes are poisonous and may cause loss of consciousness and death within a short time. Always operate your motorcycle in an area that has adequate ventilation.

- Always turn the engine off before leaving the motorcycle unattended and remove the key from the main switch. When parking the motorcycle, note the following:
  - The engine and exhaust system may be hot, therefore, park the motorcycle in a place where pedestrians or children are not likely to touch these hot areas.
  - Do not park the motorcycle on a slope or soft ground, otherwise it may fall over.
  - Do not park the motorcycle near a flammable source, (e.g., a kerosene heater, or near an open flame), otherwise it could catch fire.
- When transporting the motorcycle in another vehicle, make sure that it is kept upright. If the motorcycle should lean over, gasoline may leak out of the fuel tank.
- If you should swallow any gasoline, inhale a lot of gasoline vapor, or allow gasoline to get into your eyes, see your doctor immediately. If any gasoline spills on your skin

or clothing, immediately wash the affected area with soap and water and change your clothes.

## Location of important labels

Please read the following important labels carefully before operating this vehicle.

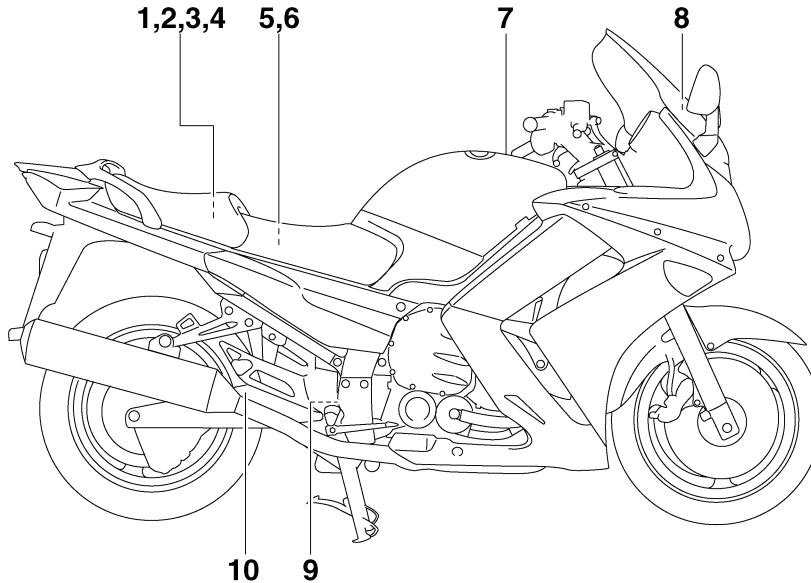

# SAFETY INFORMATION

## 1 California only

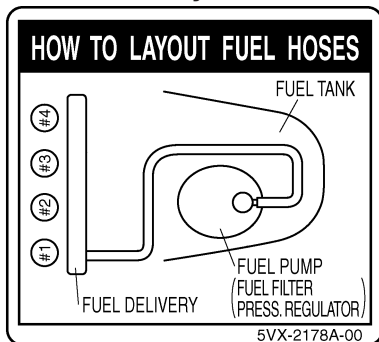

## 2 California only

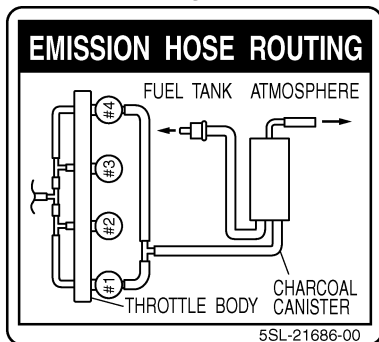

## 3 California only

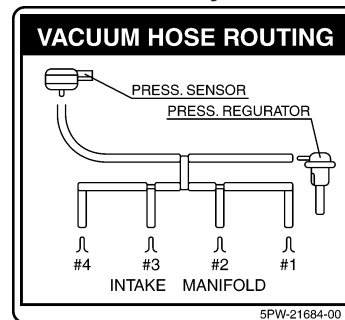

## 4

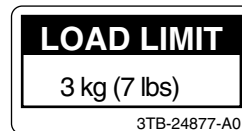

## 5

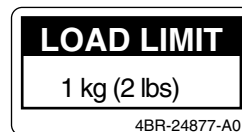

6

**⚠ WARNING**

Improper loading can cause loss of control.  
Read owner's manual for proper loading.

3JJ-28446-A1

9

**⚠ WARNING**

This unit contains high pressure nitrogen gas.  
Mishandling can cause explosion.

- Read owner's manual for instructions.
- Do not incinerate, puncture or open.

4AA-22259-80

7

**⚠ WARNING**

- BEFORE YOU OPERATE THIS VEHICLE, READ THE OWNER'S MANUAL AND ALL LABELS.
- ALWAYS WEAR AN APPROVED MOTORCYCLE HELMET, eye protection, and protective clothing.

5GK-2118K-00

8

**CAUTION**

- Cleaning with alkaline or acid cleaner, gasoline or solvent will damage windshield.
- Use neutral detergent.

5JW-00

10

**TIRE INFORMATION**

Cold tire normal pressure should be set as follows.

- Up to 90 kg (198 lbs) load

**FRONT** : 270 kPa, {2.70 kgf/cm<sup>2</sup>}, 39psi  
**REAR** : 290 kPa, {2.90 kgf/cm<sup>2</sup>}, 42psi

- 90 kg (198 lbs) ~ maximum load

**FRONT** : 270 kPa, {2.70 kgf/cm<sup>2</sup>}, 39psi  
**REAR** : 290 kPa, {2.90 kgf/cm<sup>2</sup>}, 42psi

3P6-21668-00

# DESCRIPTION

EAU10410

## Left view

2

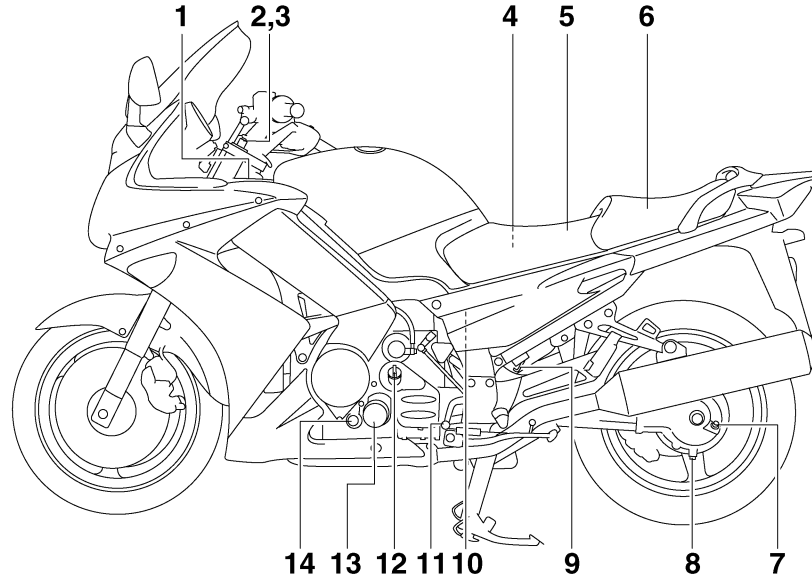

1. Accessory box (page 3-18)
2. Front fork spring preload adjusting bolt (page 3-21)
3. Front fork rebound damping force adjusting knob (page 3-21)
4. Owner's tool kit (page 6-1)
5. Rider seat (page 3-14)
6. Passenger seat (page 3-14)
7. Final gear oil filler bolt (page 6-15)
8. Final gear oil drain bolt (page 6-15)
9. Shock absorber assembly spring preload adjusting lever (page 3-23)
10. Air filter element (page 6-18)
11. Shift pedal (page 3-11)
12. Engine oil filler cap (page 6-13)
13. Engine oil filter cartridge (page 6-13)
14. Engine oil level check window (page 6-13)



## Right view

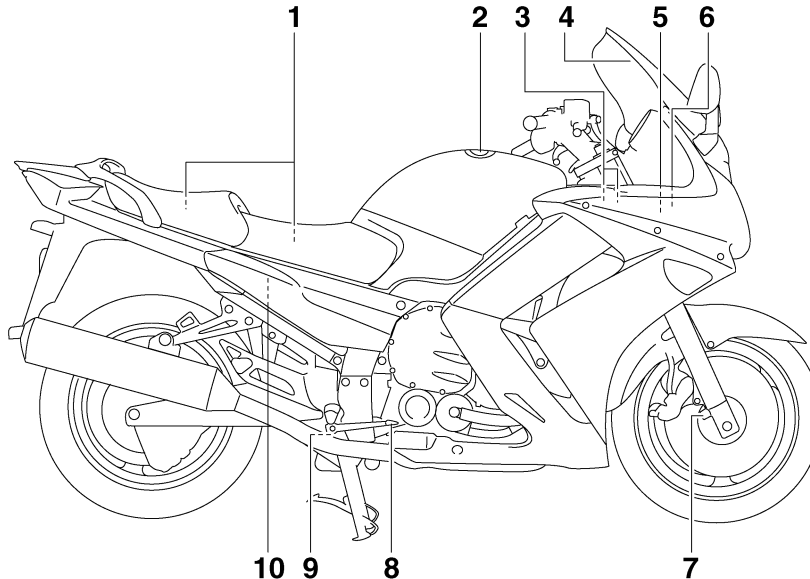

1. Storage compartment (page 3-18)
2. Fuel tank cap (page 3-12)
3. Fuse box (page 6-33)
4. Windshield (page 3-8)
5. Battery (page 6-32)
6. Main fuse (page 6-33)
7. Front fork compression damping force adjusting screw (page 3-21)
8. Brake pedal (page 3-11)
9. Shock absorber assembly rebound damping force adjusting knob (page 3-23)
10. Rear brake fluid reservoir (page 6-25)

# DESCRIPTION

EAU10430

## Controls and instruments

2

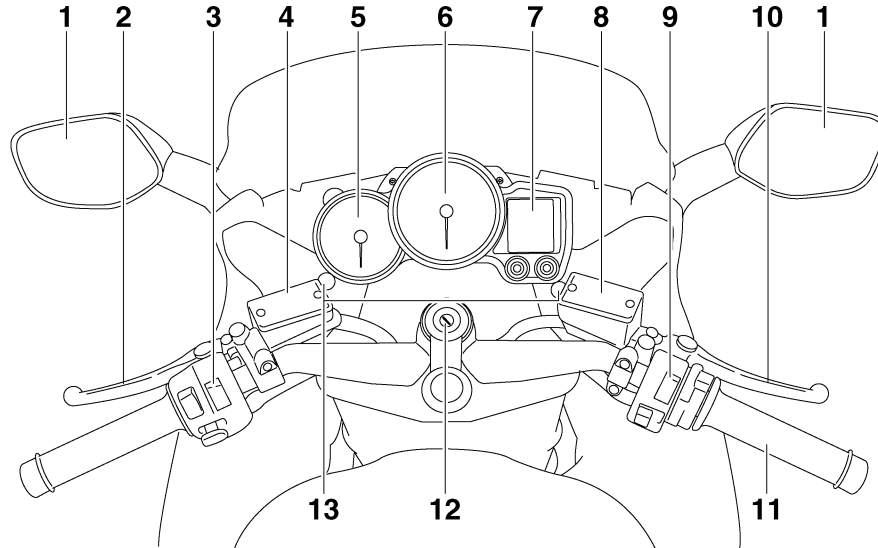

1. Rear view mirror (page 3-21)
2. Clutch lever (page 3-10)
3. Left handlebar switches (page 3-8)
4. Clutch fluid reservoir (page 6-25)
5. Tachometer (page 3-3)
6. Speedometer (page 3-3)
7. Multi-function display (page 3-4)
8. Front brake fluid reservoir (page 6-25)

9. Right handlebar switches (page 3-8)
10. Brake lever (page 3-11)
11. Throttle grip (page 6-20)
12. Main switch/steering lock (page 3-1)
13. Headlight beam adjusting knob (page 3-19)

# INSTRUMENT AND CONTROL FUNCTIONS

## Main switch/steering lock

EAU10460

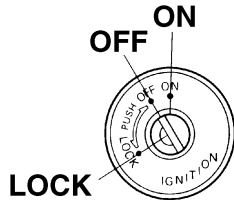

The main switch/steering lock controls the ignition and lighting systems, and is used to lock the steering. The various positions are described below.

### ON

EAU35921

All electrical circuits are supplied with power, and the meter lighting, taillights, license plate light and position lights come on, and the engine can be started. The key cannot be removed.

### NOTE:

The headlights come on automatically when the engine is started and stay on until the key is turned to "OFF", even if the engine stalls.

### OFF

EAU10660

All electrical systems are off. The key can be removed.

### LOCK

EAU10690

The steering is locked, and all electrical systems are off. The key can be removed.

### To lock the steering

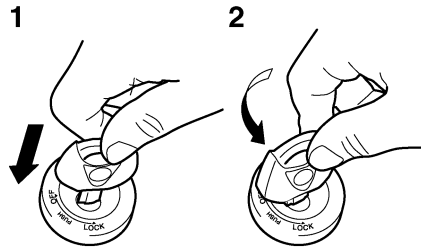

1. Push.
2. Turn.

1. Turn the handlebars all the way to the left or right.
2. Push the key in from the "OFF" position, and then turn it to "LOCK" while still pushing it.
3. Remove the key.

### To unlock the steering

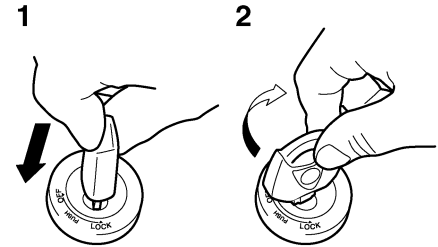

1. Push.
2. Turn.

Push the key into the main switch, and then turn it to "OFF" while still pushing it.

### **! WARNING**

EWA10060

Never turn the key to "OFF" or "LOCK" while the vehicle is moving, otherwise the electrical systems will be switched off, which may result in loss of control or an accident. Make sure that the vehicle is stopped before turning the key to "OFF" or "LOCK".

# INSTRUMENT AND CONTROL FUNCTIONS

## Indicator and warning lights

EAU11003

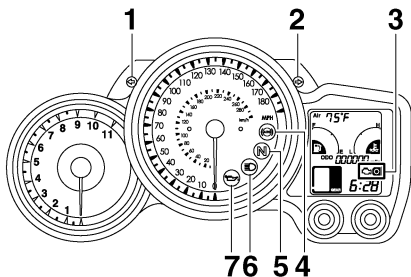

1. Left turn signal indicator light “”
2. Right turn signal indicator light “”
3. Engine trouble warning light “”
4. Anti-lock Brake System (ABS) warning light “”
5. Neutral indicator light “**N**”
6. High beam indicator light “”
7. Oil level warning light “”

## Turn signal indicator lights “” and “”

EAU11030

The corresponding indicator light flashes when the turn signal switch is pushed to the left or right.

## Neutral indicator light “**N**”

EAU11060

This indicator light comes on when the transmission is in the neutral position.

## High beam indicator light “”

EAU11080

This indicator light comes on when the high beam of the headlight is switched on.

## Oil level warning light “”

EAU11120

This warning light comes on when the engine oil level is low.

The electrical circuit of the warning light can be checked by turning the key to “ON”.

If the warning light does not come on for a few seconds, then go off, have a Yamaha dealer check the electrical circuit.

## NOTE: \_\_\_\_\_

Even if the oil level is sufficient, the warning light may flicker when riding on a slope or during sudden acceleration or deceleration, but this is not a malfunction.

## Engine trouble warning light “”

EAU11530

This warning light comes on or flashes when an electrical circuit monitoring the engine is defective. When this occurs, have a Yamaha dealer check the self-diagnosis system. (See page 3-4 for an explanation of the self-diagnosis device.)

The electrical circuit of the warning light can be checked by turning the key to “ON”. If the warning light does not come on for a few seconds, then go off, have a Yamaha dealer check the electrical circuit.

## ABS warning light “”

EAU39500

If this warning light comes on or flashes while riding, the ABS may be defective. If this occurs, have a Yamaha dealer check the system as soon as possible. (See page 3-12.)

## WARNING

EWA10081

**If the ABS warning light comes on or flashes while riding, the brake system reverts to conventional braking. Therefore, be careful not to cause the wheels to lock during emergen-**

# INSTRUMENT AND CONTROL FUNCTIONS

cy braking. If the warning light comes on or flashes while riding, have a Yamaha dealer check the brake system as soon as possible.

The electrical circuit of the warning light can be checked by turning the key to "ON".

If the warning light does not come on or remains on, have a Yamaha dealer check the electrical circuit.

## Speedometer

EAU11601

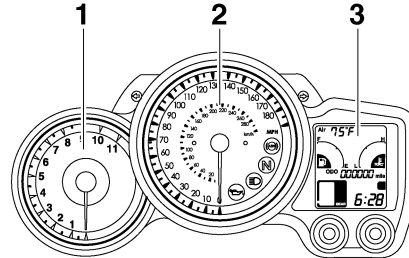

1. Tachometer
2. Speedometer
3. Multi-function display

The speedometer shows the riding speed.

When the key is turned to "ON", the speedometer needle will sweep once across the speed range and then return to zero in order to test the electrical circuit.

## Tachometer

EAU11872

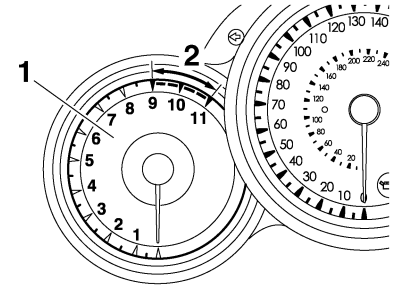

1. Tachometer
2. Tachometer red zone

The electric tachometer allows the rider to monitor the engine speed and keep it within the ideal power range.

When the key is turned to "ON", the tachometer needle will sweep once across the r/min range and then return to zero r/min in order to test the electrical circuit.

### CAUTION:

**Do not operate the engine in the tachometer red zone.**

**Red zone: 9000 r/min and above**

ECA10031

# INSTRUMENT AND CONTROL FUNCTIONS

## Multi-function display

EAU40290

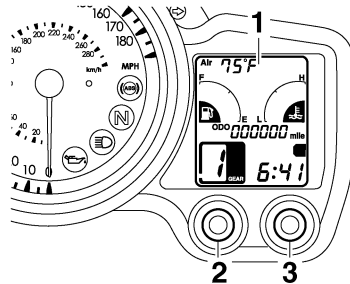

1. Multi-function display
2. "SELECT" button
3. "RESET" button

## **⚠ WARNING**

Be sure to stop the vehicle before making any setting changes to the multi-function display.

The multi-function display is equipped with the following:

- an odometer (which shows the total distance traveled)
- two tripmeters (which show the distance traveled since they were last set to zero)

- a fuel reserve tripmeter (which shows the distance traveled on the fuel reserve)
- a clock
- a fuel meter
- a coolant temperature meter
- a transmission gear display
- an ambient temperature display
- a fuel consumption display (instantaneous and average consumption functions)
- a self-diagnosis device

**NOTE:** \_\_\_\_\_  
Be sure to turn the key to "ON" before using the "SELECT" and "RESET" buttons.  
\_\_\_\_\_

EWA14430

## Odometer and tripmeter modes

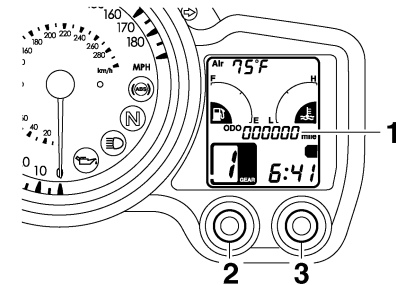

1. Odometer/tripmeter/fuel reserve tripmeter
2. "SELECT" button
3. "RESET" button

Pushing the "SELECT" button switches the display between the odometer mode "ODO" and the tripmeter modes "TRIP 1" and "TRIP 2" in the following order:

ODO → TRIP 1 → TRIP 2 → ODO

**NOTE:** \_\_\_\_\_  
When selecting "TRIP 1" or "TRIP 2", the display flashes for five seconds.

When approximately 5.5 L (1.45 US gal) (1.21 Imp.gal) of fuel remains in the fuel tank, the display will automatically change to the fuel reserve tripmeter mode "F-TRIP" and start counting the

# INSTRUMENT AND CONTROL FUNCTIONS

distance traveled from that point. In that case, pushing the “SELECT” button switches the display between the various tripmeter and odometer modes in the following order:

F-TRIP → TRIP 1 → TRIP 2 → ODO → F-TRIP

To reset a tripmeter, select it by pushing the “SELECT” button, and then push the “SELECT” button for at least one second. If you do not reset the fuel reserve tripmeter manually, it will reset itself automatically and the display will return to the prior mode after refueling and traveling 5 km (3 mi).

## Clock

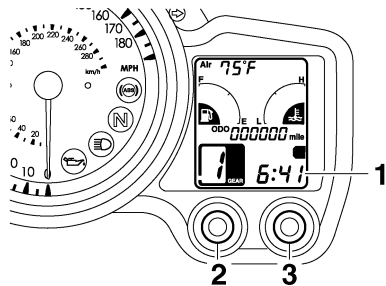

1. Clock
2. “SELECT” button
3. “RESET” button

## To set the clock:

1. Push the “SELECT” button and “RESET” button together for at least two seconds.
2. When the hour digits start flashing, push the “RESET” button to set the hours.
3. Push the “SELECT” button, and the minute digits will start flashing.
4. Push the “RESET” button to set the minutes.
5. Push the “SELECT” button and then release it to start the clock.

## Fuel meter

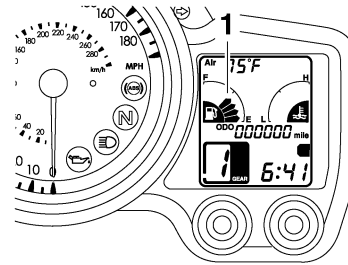

1. Fuel meter

The fuel meter indicates the amount of fuel in the fuel tank. The display segments of the fuel meter disappear to-

wards “E” (Empty) as the fuel level decreases. When the last segment starts flashing, refuel as soon as possible. When the key is turned to “ON”, all of the display segments of the fuel meter will appear one after the other and then disappear in order to test the electrical circuit.

## NOTE:

This fuel meter is equipped with a self-diagnosis system. If the electrical circuit is defective, all the display segments will start flashing. If this occurs, have a Yamaha dealer check the electrical circuit.

## Coolant temperature meter

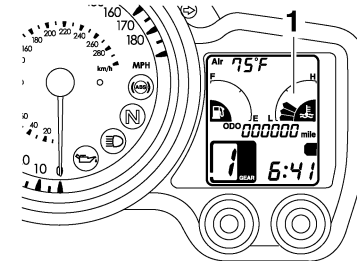

1. Coolant temperature meter

# INSTRUMENT AND CONTROL FUNCTIONS

3

With the key in the “ON” position, the coolant temperature meter indicates the temperature of the coolant. When the key is turned to “ON”, all of the display segments of the coolant temperature meter will appear one after the other and then disappear in order to test the electrical circuit. The coolant temperature varies with changes in the weather and engine load. If the top segment flashes, stop the vehicle and let the engine cool. (See page 6-38.)

ECA10020

## CAUTION:

**Do not operate the engine if it is overheated.**

## Transmission gear display

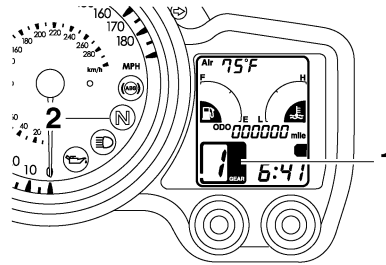

1. Transmission gear display
2. Neutral indicator light “N”

This display shows the selected gear. The neutral position, however, is not displayed, it is indicated by the neutral indicator light.

## Ambient temperature, instantaneous fuel consumption and average fuel consumption modes

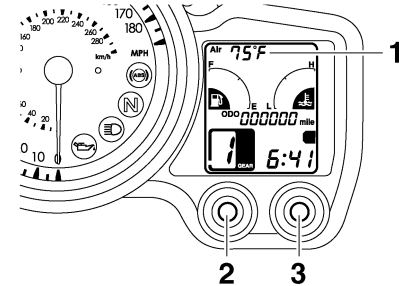

1. Ambient temperature/instantaneous fuel consumption/average fuel consumption
2. “SELECT” button
3. “RESET” button

Push the “RESET” button to switch the display between the ambient temperature mode “Air”, the instantaneous fuel consumption mode “MPG” and the average fuel consumption mode “AV\_\_MPG” in the following order:  
Air → MPG → AV\_\_MPG → Air



# INSTRUMENT AND CONTROL FUNCTIONS

## Ambient temperature mode

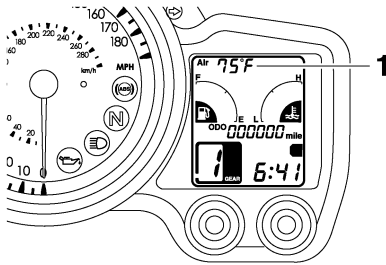

1. Ambient temperature

This display shows the ambient temperature from 16 °F to 122 °F in 1 °F increments. The temperature displayed may vary from the ambient temperature.

### NOTE:

- If the ambient temperature falls below 16 °F, a lower temperature than 16 °F will not be displayed.
- If the ambient temperature climbs above 122 °F, a higher temperature than 122 °F will not be displayed.
- The accuracy of the temperature reading may be affected when riding slowly [approximately under

20 km/h (12.5 mi/h)] or when stopped at traffic signals, railroad crossings, etc.

## Instantaneous fuel consumption mode

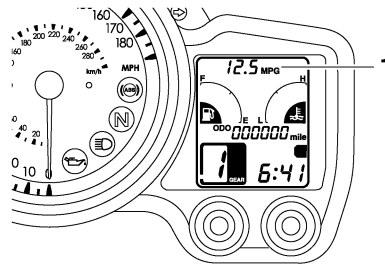

1. Instantaneous fuel consumption

This display shows the distance that can be traveled on 1.0 US.gal of fuel under the current riding conditions.

### NOTE:

If traveling at speeds under 10 km/h (6.0 mi/h), “\_ \_ \_” will be displayed.

## Average fuel consumption mode

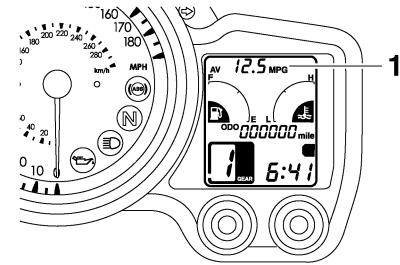

1. Average fuel consumption

This display shows the average fuel consumption since it was last reset. When the average fuel consumption mode is selected, the display flashes for five seconds, and then “AV \_ \_ MPG” (average distance that can be traveled using 1.0 US.gal of fuel) is displayed.

### NOTE:

- To reset the average fuel consumption display, push the “RESET” button to select the mode again, and then push the “RESET” button for 1 second while the display is flashing.

# INSTRUMENT AND CONTROL FUNCTIONS

- After resetting the average fuel consumption display, “\_ \_” will be shown for that display until the vehicle has traveled 1 km (0.6 mi).

ECA15471

## CAUTION:

If there is a malfunction, “\_ \_” will be displayed. Have a Yamaha dealer check the vehicle.

3

## Self-diagnosis device

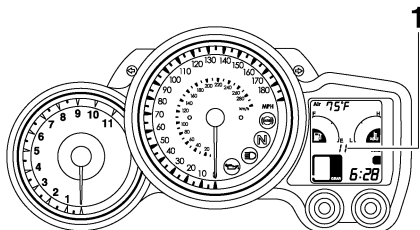

1. Error code display

This model is equipped with a self-diagnosis device for various electrical circuits.

If any of those circuits are defective, the multi-function display will indicate a two-digit error code (e.g., 11, 12, 13).

If the multi-function display indicates such an error code, note the code number, and then have a Yamaha dealer check the vehicle.

ECA11790

## CAUTION:

If the multi-function display indicates an error code, the vehicle should be checked as soon as possible in order to avoid engine damage.

## Handlebar switches

EAU12344

### Left

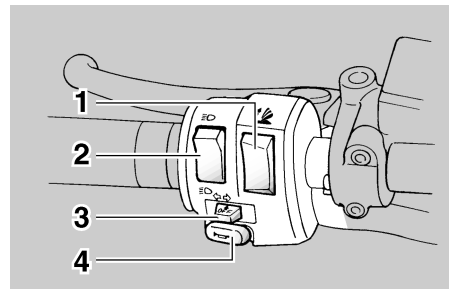

1. Windshield position adjusting switch “”
2. Dimmer switch “/”
3. Turn signal switch “/”
4. Horn switch “”

# INSTRUMENT AND CONTROL FUNCTIONS

## Right

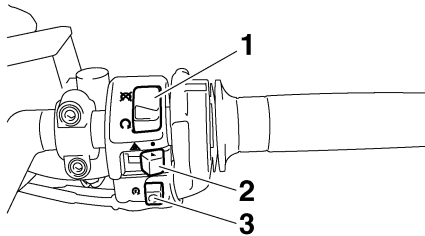

1. Engine stop switch “○/⊗”
2. Hazard switch “△”
3. Start switch “⊕”

### Dimmer switch “≡○/⊖○”

EAU12400

Set this switch to “≡○” for the high beam and to “⊖○” for the low beam.

### Turn signal switch “⇐/⇒”

EAU12460

To signal a right-hand turn, push this switch to “⇒”. To signal a left-hand turn, push this switch to “⇐”. When released, the switch returns to the center position. To cancel the turn signal lights, push the switch in after it has returned to the center position.

### Windshield position adjusting switch “↕”

EAU12493

To move the windshield up, push this switch in direction (a). To move the windshield down, push the switch in direction (b).

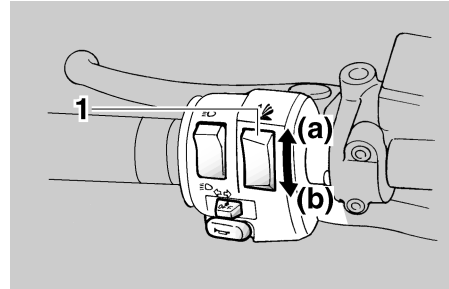

1. Windshield position adjusting switch “↕”

### NOTE:

When the key is turned to “OFF”, the windshield will automatically return to the lowest position.

### Horn switch “♫”

EAU12500

Press this switch to sound the horn.

### Engine stop switch “○/⊗”

EAU12660

Set this switch to “○” before starting the engine. Set this switch to “⊗” to stop the engine in case of an emergency, such as when the vehicle overturns or when the throttle cable is stuck.

### Start switch “⊕”

EAU12710

Push this switch to crank the engine with the starter.

### CAUTION:

See page 5-1 for starting instructions prior to starting the engine.

### Hazard switch “△”

EAU12764

With the key in the “ON” position, turn this switch to “△” to turn on the hazard lights (simultaneous flashing of all turn signal lights).

The hazard lights are used in case of an emergency or to warn other drivers when your vehicle is stopped where it might be a traffic hazard.

# INSTRUMENT AND CONTROL FUNCTIONS

ECA10061

## CAUTION:

Do not use the hazard lights for an extended length of time with the engine not running, otherwise the battery may discharge.

EAU12830

## Clutch lever

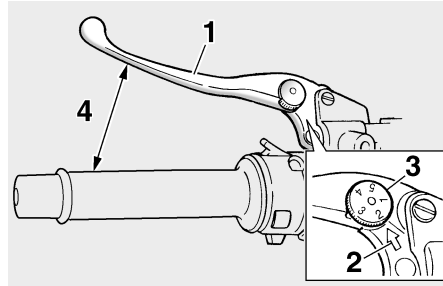

1. Clutch lever
2. Arrow mark
3. Clutch lever position adjusting dial
4. Distance between clutch lever and handlebar grip

The clutch lever is located at the left handlebar grip. To disengage the clutch, pull the lever toward the handlebar grip. To engage the clutch, release the lever. The lever should be pulled rapidly and released slowly for smooth clutch operation.

The clutch lever is equipped with a clutch lever position adjusting dial. To adjust the distance between the clutch lever and the handlebar grip, turn the adjusting dial while holding the lever pushed away from the handlebar grip.

Make sure that the appropriate setting on the adjusting dial is aligned with the arrow mark on the clutch lever.

The clutch lever is equipped with a clutch switch, which is part of the ignition circuit cut-off system. (See page 3-25.)

## Shift pedal

EAU12870

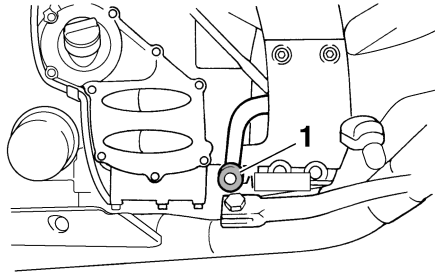

1. Shift pedal

The shift pedal is located on the left side of the engine and is used in combination with the clutch lever when shifting the gears of the 5-speed constant-mesh transmission equipped on this motorcycle.

## Brake lever

EAU26822

The brake lever is located at the right handlebar grip. To apply the front brake, pull the lever toward the handlebar grip.

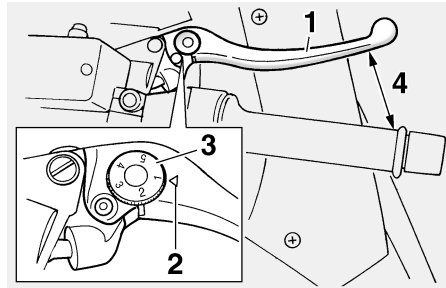

1. Brake lever
2. "△" mark
3. Brake lever position adjusting dial
4. Distance between brake lever and handlebar grip

The brake lever is equipped with a position adjusting dial. To adjust the distance between the brake lever and the handlebar grip, turn the adjusting dial while holding the lever pushed away from the handlebar grip. Make sure that the appropriate setting on the adjusting dial is aligned with the "△" mark on the brake lever.

## Brake pedal

EAU39540

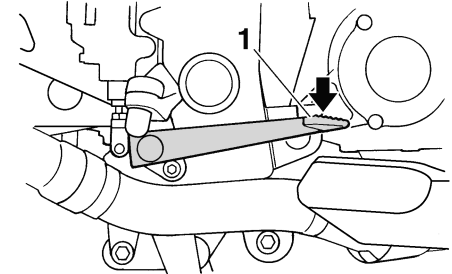

1. Brake pedal

The brake pedal is on the right side of the vehicle.

This model is equipped with a unified brake system.

When pressing down on the brake pedal, the rear brake and a portion of the front brake are applied. For full braking performance, apply both the brake lever and the brake pedal simultaneously.

# INSTRUMENT AND CONTROL FUNCTIONS

3

## ABS

EAU39530

The Yamaha ABS (Anti-lock Brake System) features a dual electronic control system, which acts on the front and rear brakes independently. The ABS is monitored by an ECU (Electronic Control Unit), which will have recourse to manual braking if a malfunction occurs.

EWA10090

### WARNING

- The ABS performs best on long braking distances.
- On certain (rough or gravel) roads, the braking distance may be longer with than without the ABS. Therefore, always keep a sufficient distance to the vehicle ahead to match the riding speed.

### NOTE: \_\_\_\_\_

- When the ABS is activated, the brakes are operated in the usual way. A pulsating action may be felt at the brake lever or brake pedal, but this does not indicate a malfunction.

- This ABS has a test mode which allows the owner to experience the pulsating at the brake lever or brake pedal when the ABS is operating. However, special tools are required, so please consult your Yamaha dealer when performing this test.

## Fuel tank cap

EAU13070

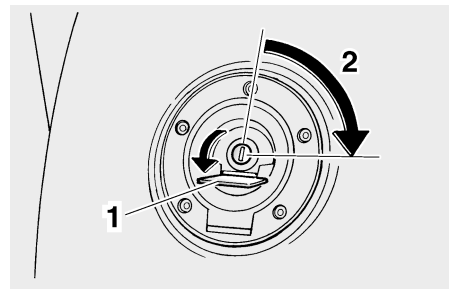

1. Fuel tank cap lock cover
2. Unlock.

### To open the fuel tank cap

Open the fuel tank cap lock cover, insert the key into the lock, and then turn it 1/4 turn clockwise. The lock will be released and the fuel tank cap can be opened.

### To close the fuel tank cap

1. Push the fuel tank cap into position with the key inserted in the lock.
2. Turn the key counterclockwise to the original position, remove it, and then close the lock cover.

# INSTRUMENT AND CONTROL FUNCTIONS

## NOTE: \_\_\_\_\_

The fuel tank cap cannot be closed unless the key is in the lock. In addition, the key cannot be removed if the cap is not properly closed and locked.

EWA11090

## WARNING \_\_\_\_\_

**Make sure that the fuel tank cap is properly closed before riding.**

## Fuel

EAU13220

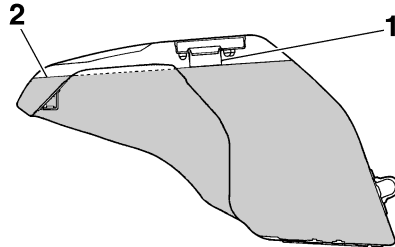

1. Fuel tank filler tube
2. Fuel level

Make sure that there is sufficient fuel in the tank. When refueling, be sure to insert the pump nozzle into the fuel tank filler hole and to fill the tank to the bottom of the filler tube as shown.

EWA10880

## WARNING \_\_\_\_\_

- Do not overfill the fuel tank, otherwise it may overflow when the fuel warms up and expands.
- Avoid spilling fuel on the hot engine.

ECA10070

## CAUTION: \_\_\_\_\_

**Immediately wipe off spilled fuel with a clean, dry, soft cloth, since fuel may deteriorate painted surfaces or plastic parts.**

EAU13300

3

### Recommended fuel:

UNLEADED GASOLINE ONLY

### Fuel tank capacity:

25.0 L (6.61 US gal) (5.50 Imp.gal)

### Fuel reserve amount:

5.5 L (1.45 US gal) (1.21 Imp.gal)

ECA11400

## CAUTION: \_\_\_\_\_

**Use only unleaded gasoline. The use of leaded gasoline will cause severe damage to internal engine parts, such as the valves and piston rings, as well as to the exhaust system.**

Your Yamaha engine has been designed to use regular unleaded gasoline with a pump octane number  $[(R+M)/2]$  of 86 or higher, or a research octane number of 91 or higher. If

# INSTRUMENT AND CONTROL FUNCTIONS

knocking (or pinging) occurs, use a gasoline of a different brand or premium unleaded fuel. Use of unleaded fuel will extend spark plug life and reduce maintenance costs.

## Gasohol

There are two types of gasohol: gasohol containing ethanol and that containing methanol. Gasohol containing ethanol can be used if the ethanol content does not exceed 10%. Gasohol containing methanol is not recommended by Yamaha because it can cause damage to the fuel system or vehicle performance problems.

3

## Catalytic converter

EAU13441

This vehicle is equipped with catalytic converters in the exhaust system.

EWA10860

### **⚠ WARNING**

**The exhaust system is hot after operation. Make sure that the exhaust system has cooled down before doing any maintenance work.**

ECA10700

### **CAUTION:**

**The following precautions must be observed to prevent a fire hazard or other damages.**

- **Use only unleaded gasoline. The use of leaded gasoline will cause unreparable damage to the catalytic converter.**
- **Never park the vehicle near possible fire hazards such as grass or other materials that easily burn.**
- **Do not allow the engine to idle too long.**

## Seats

EAU39491

### Passenger seat

To remove the passenger seat

1. Insert the key into the seat lock, and then turn it counterclockwise.

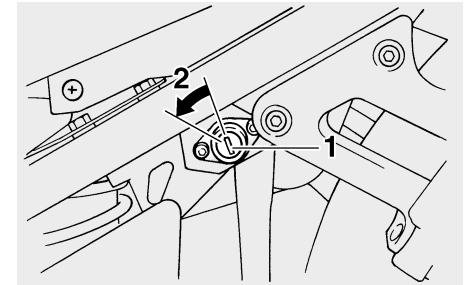

1. Passenger seat lock
2. Unlock.

2. Lift the front of the passenger seat and pull it forward.

To install the passenger seat

1. Insert the projections on the rear of the passenger seat into the seat holders as shown, and then push the front of the seat down to lock it in place.



# INSTRUMENT AND CONTROL FUNCTIONS

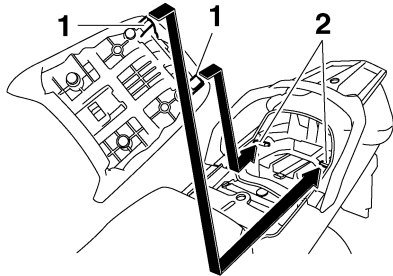

1. Projection
2. Seat holder

2. Remove the key.

## Rider seat

### To remove the rider seat

1. Remove the passenger seat.
2. Push the rider seat lock lever, located under the back of the rider seat, to the left as shown, and then pull the seat off.

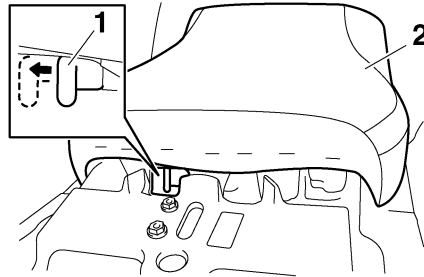

1. Rider seat lock lever
2. Rider seat

### To install the rider seat

1. Insert the projection on the front of the rider seat into the seat holder as shown, and then push the rear of the seat down to lock it in place.

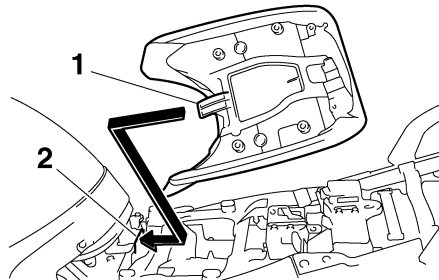

1. Projection
2. Seat holder

2. Install the passenger seat.

**NOTE:** \_\_\_\_\_

- Make sure that the seats are properly secured before riding.
- The rider seat height can be adjusted to change the riding position. (See page 3-16.)

# INSTRUMENT AND CONTROL FUNCTIONS

EAU39632

## Adjusting the rider seat height

The rider seat height can be adjusted to one of two positions to suit the rider's preference.

The rider seat height was adjusted to the lower position at delivery.

3

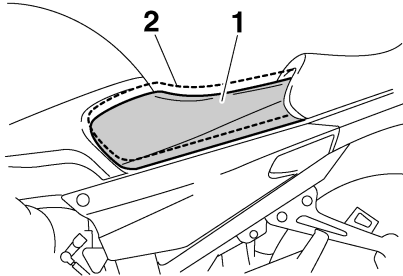

1. Low position
2. High position

## To change the rider seat height to the high position

1. Remove the rider seat. (See page 3-14.)
2. Remove the rider seat height position adjuster by pulling it upward.

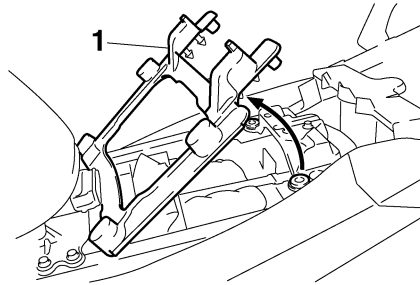

1. Rider seat height position adjuster

3. Move the rider seat holder cover to the lower position as shown.

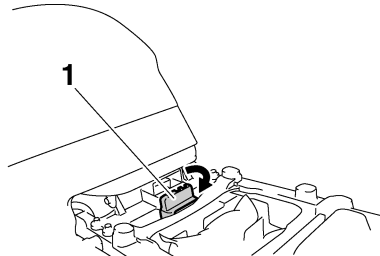

1. Rider seat holder cover

4. Install the rider seat height position adjuster so that the "H" mark is aligned with the match mark.

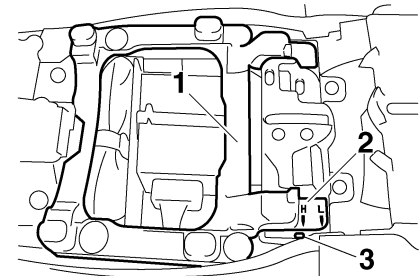

1. Rider seat height position adjuster
2. "H" mark
3. Match mark

5. Insert the projection on the front of the rider seat into seat holder B as shown.

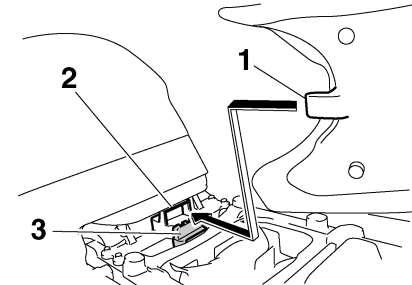

1. Projection
2. Seat holder B (for high position)
3. Rider seat holder cover

# INSTRUMENT AND CONTROL FUNCTIONS

6. Align the projection on the bottom of the rider seat with the "H" position slot, and then push the rear of the seat down to lock it in place as shown.

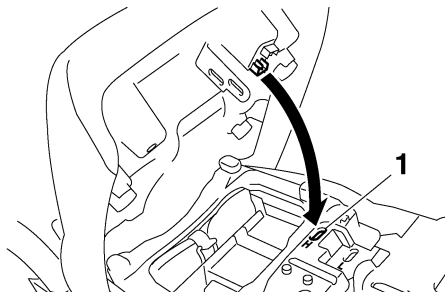

1. "H" position slot

7. Install the passenger seat.

## To change the rider seat height to the low position

1. Remove the rider seat. (See page 3-14.)
2. Remove the rider seat height position adjuster by pulling it upward.
3. Move the rider seat holder cover to the upper position.
4. Install the rider seat height position adjuster so that the "L" mark is aligned with the match mark.

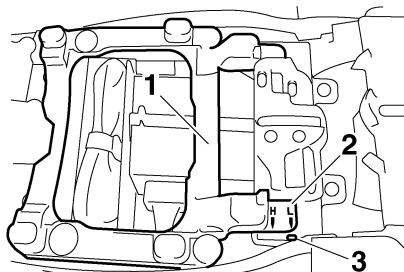

1. Rider seat height position adjuster
2. "L" mark
3. Match mark

5. Insert the projection on the front of the rider seat into seat holder A as shown.

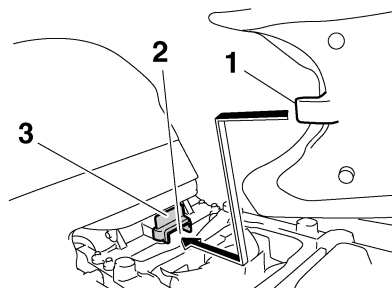

1. Projection
2. Seat holder A (for low position)
3. Rider seat holder cover

6. Align the projection on the bottom of the rider seat with the "L" position slot, and then push the rear of the seat down to lock it in place as shown.

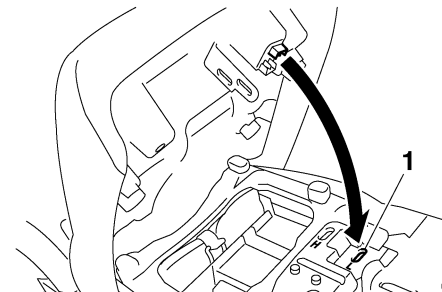

1. "L" position slot

7. Install the passenger seat.

## NOTE:

Make sure that the seats are properly secured before riding.

# INSTRUMENT AND CONTROL FUNCTIONS

EAU40250

## Storage compartments

This vehicle is equipped with two storage compartments.

Storage compartment A is located under the rider seat. (See page 3-14.)

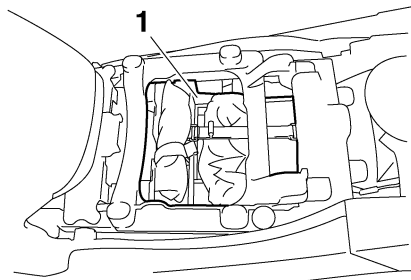

1. Storage compartment A

Storage compartment B is located under the passenger seat. (See page 3-14.)

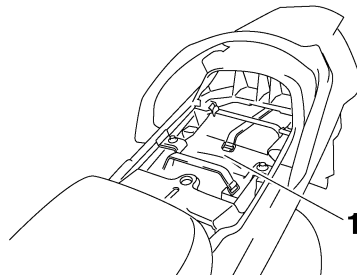

1. Storage compartment B

EWA14420

### WARNING

- Do not exceed the load limit of 1 kg (2 lb) for storage compartment A.
- Do not exceed the load limit of 3 kg (7 lb) for storage compartment B.
- Do not exceed the maximum load of 211 kg (465 lb) (CAL) 212 kg (467 lb) (U49) for the vehicle.

## Accessory box

EAU39480

The accessory box is located beside the meter panel.

### To open the accessory box

1. Insert the key into the main switch, and then turn it to "ON".
2. Push the accessory box button, and then open the accessory box lid.

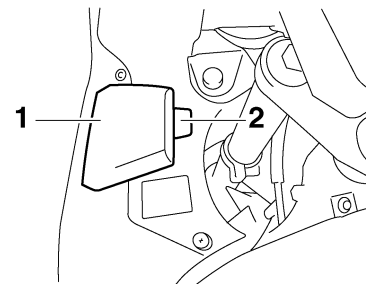

1. Accessory box
2. Accessory box button

3. Turn the key to "OFF" to preserve the battery.

### To close the accessory box

1. Fold the accessory box lid down.
2. Remove the key.

ECA11800

## CAUTION:

Do not place heat-sensitive items in the accessory box. The accessory box gets extremely hot especially when the engine is running or is hot.

EWA11421

## WARNING

- Do not exceed the load limit of 0.3 kg (0.66 lb) for the accessory box.
- Do not exceed the maximum load of 211 kg (465 lb) (CAL) 212 kg (467 lb) (U49) for the vehicle.

EAU39610

## Adjusting the headlight beams

The headlight adjusting knobs are used to raise or lower the height of the headlight beams. It may be necessary to adjust the headlight beams to increase visibility and help prevent blinding oncoming drivers when carrying more or less load than usual. Obey local laws and regulations when adjusting the headlights.

To raise the headlight beams, turn the knobs in direction (a). To lower the headlight beams, turn the knobs in direction (b).

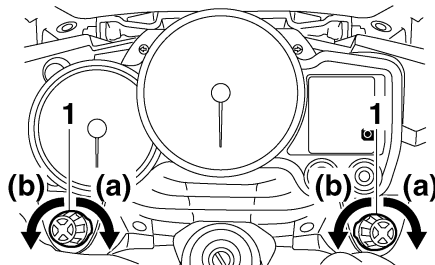

1. Headlight beam adjusting knob

EAU39641

## Handlebar position

The handlebars can be adjusted to one of three positions to suit the rider's preference. Have a Yamaha dealer adjust the position of the handlebars.

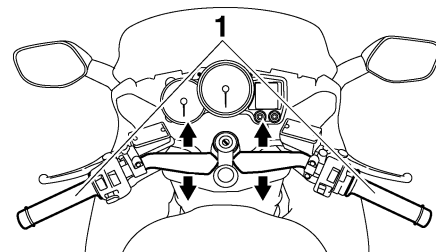

1. Handlebar

# INSTRUMENT AND CONTROL FUNCTIONS

EAU39621

## Opening and closing the cowlings

The cowlings can be tilted back 30 mm (1.18 in) for added ventilation to suit the riding conditions.

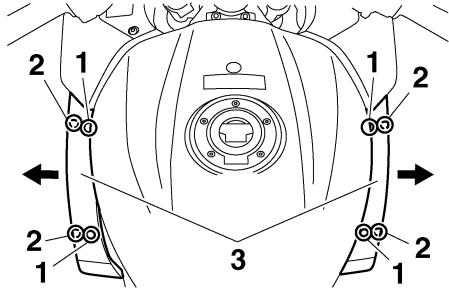

1. Closed position
2. Open position
3. Cowling

### To open a cowling

1. Remove the quick fastener screws.

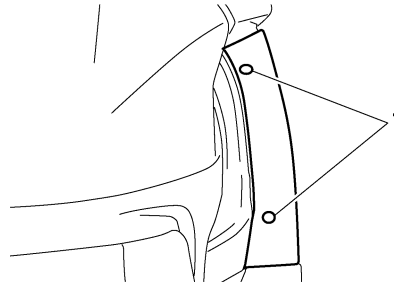

1. Quick fastener screw

2. Pull the cowling to the open position, and then install the quick fastener screws.

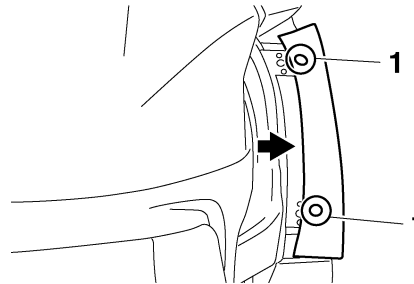

1. Open position

### To close a cowling

1. Remove the quick fastener screws.

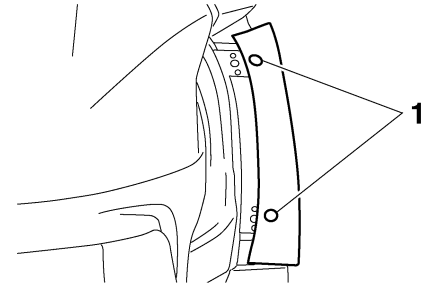

1. Quick fastener screw

2. Push the cowling to the closed position, and then install the quick fastener screws.

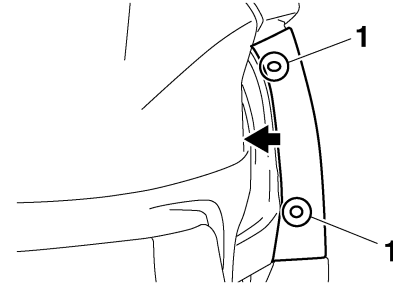

1. Closed position

### NOTE:

Make sure that the cowling is properly installed before riding.

# INSTRUMENT AND CONTROL FUNCTIONS

## Rear view mirrors

EAU39671

The rear view mirrors of this vehicle can be folded forward or backward for parking in narrow spaces. Fold the mirrors back to their original position before riding.

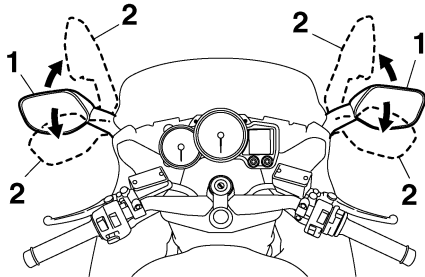

1. Riding position
2. Parking position

EWA14371

### **WARNING**

**Be sure to fold the rear view mirrors back to their original position before riding.**

## Adjusting the front fork

EAU14731

This front fork is equipped with spring preload adjusting bolts, rebound damping force adjusting knobs and compression damping force adjusting screws.

EWA10180

### **WARNING**

**Always adjust both fork legs equally, otherwise poor handling and loss of stability may result.**

## Spring preload

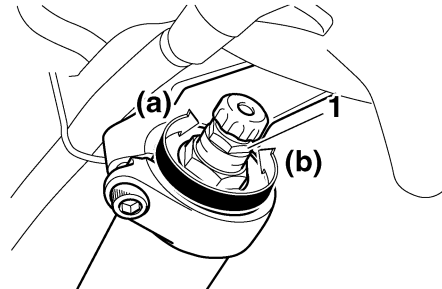

1. Spring preload adjusting bolt

To increase the spring preload and thereby harden the suspension, turn the adjusting bolt on each fork leg in direction (a). To decrease the spring pre-

load and thereby soften the suspension, turn the adjusting bolt on each fork leg in direction (b).

### **NOTE:**

Align the appropriate groove on the adjusting mechanism with the top of the front fork cap bolt.

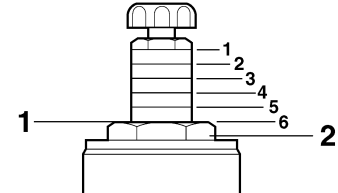

1. Current setting
2. Front fork cap bolt

### **Spring preload setting:**

Minimum (soft):

6

Standard:

4

Maximum (hard):

1

# INSTRUMENT AND CONTROL FUNCTIONS

ECA10100

## Rebound damping force

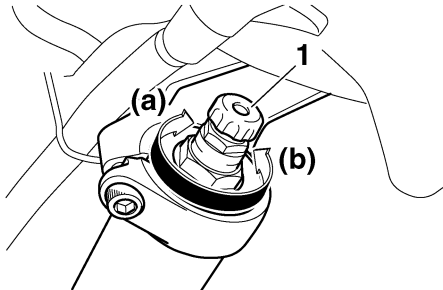

1. Rebound damping force adjusting knob

To increase the rebound damping force and thereby harden the rebound damping, turn the adjusting knob on each fork leg in direction (a). To decrease the rebound damping force and thereby soften the rebound damping, turn the adjusting knob on each fork leg in direction (b).

### Rebound damping setting:

Minimum (soft):

17 click(s) in direction (b)\*

Standard:

12 click(s) in direction (b)\*

Maximum (hard):

1 click(s) in direction (b)\*

\* With the adjusting knob fully turned in direction (a)

## Compression damping force

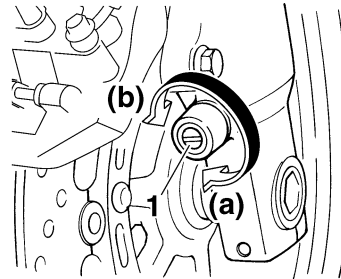

1. Compression damping force adjusting screw

To increase the compression damping force and thereby harden the compression damping, turn the adjusting screw on each fork leg in direction (a). To decrease the compression damping force and thereby soften the compression damping, turn the adjusting screw on each fork leg in direction (b).

### Compression damping setting:

Minimum (soft):

21 click(s) in direction (b)\*

Standard:

12 click(s) in direction (b)\*

Maximum (hard):

1 click(s) in direction (b)\*

\* With the adjusting screw fully turned in direction (a)

### CAUTION:

Never attempt to turn an adjusting mechanism beyond the maximum or minimum settings.

### NOTE:

Although the total number of clicks of a damping force adjusting mechanism may not exactly match the above specifications due to small differences in production, the actual number of clicks always represents the entire adjusting range. To obtain a precise adjustment, it would be advisable to check the number of clicks of each damping force adjusting mechanism and to modify the specifications as necessary.



## Adjusting the shock absorber assembly

EAU14911

This shock absorber assembly is equipped with a spring preload adjusting lever and a rebound damping force adjusting knob.

ECA10100

### CAUTION:

Never attempt to turn an adjusting mechanism beyond the maximum or minimum settings.

### Spring preload

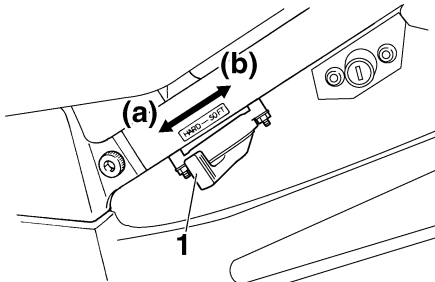

1. Spring preload adjusting lever

For riding solo, move the spring preload adjusting lever in direction (b). For riding with a passenger, move the spring preload adjusting lever in direction (a).

### Rebound damping force

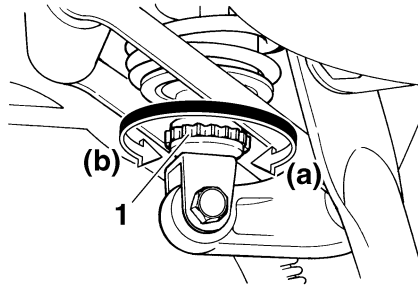

1. Rebound damping force adjusting knob

To increase the rebound damping force and thereby harden the rebound damping, turn the adjusting knob in direction (a). To decrease the rebound damping force and thereby soften the rebound damping, turn the adjusting knob in direction (b).

### Rebound damping setting:

Minimum (soft):

20 click(s) in direction (b)\*

Standard:

12 click(s) in direction (b)\*

Maximum (hard):

3 click(s) in direction (b)\*

\* With the adjusting knob fully turned in direction (a)

EWA10220

### WARNING

This shock absorber contains highly pressurized nitrogen gas. For proper handling, read and understand the following information before handling the shock absorber. The manufacturer cannot be held responsible for property damage or personal injury that may result from improper handling.

- Do not tamper with or attempt to open the gas cylinder.
- Do not subject the shock absorber to an open flame or other high heat sources, otherwise it may explode due to excessive gas pressure.

# INSTRUMENT AND CONTROL FUNCTIONS

---

- Do not deform or damage the gas cylinder in any way, as this will result in poor damping performance.
  - Always have a Yamaha dealer service the shock absorber.
- 

3

## Sidestand

EAU15301

The sidestand is located on the left side of the frame. Raise the sidestand or lower it with your foot while holding the vehicle upright.

### NOTE: \_\_\_\_\_

The built-in sidestand switch is part of the ignition circuit cut-off system, which cuts the ignition in certain situations. (See further down for an explanation of the ignition circuit cut-off system.)

EWA10240

### **WARNING** \_\_\_\_\_

The vehicle must not be ridden with the sidestand down, or if the sidestand cannot be properly moved up (or does not stay up), otherwise the sidestand could contact the ground and distract the operator, resulting in a possible loss of control. Yamaha's ignition circuit cut-off system has been designed to assist the operator in fulfilling the responsibility of raising the sidestand before starting off. Therefore, check this system regularly as described

below and have a Yamaha dealer repair it if it does not function properly.

---

EAU15321

## Ignition circuit cut-off system

The ignition circuit cut-off system (comprising the sidestand switch, clutch switch and neutral switch) has the following functions.

- It prevents starting when the transmission is in gear and the sidestand is up, but the clutch lever is not pulled.
- It prevents starting when the transmission is in gear and the clutch lever is pulled, but the sidestand is still down.
- It cuts the running engine when the transmission is in gear and the sidestand is moved down.

Periodically check the operation of the ignition circuit cut-off system according to the following procedure.

EWA10260

### **WARNING**

- **The vehicle must be placed on the centerstand during this inspection.**
- **If a malfunction is noted, have a Yamaha dealer check the system before riding.**

# INSTRUMENT AND CONTROL FUNCTIONS

3

With the engine turned off:  
1. Move the sidestand down.  
2. Make sure that the engine stop switch is turned on.  
3. Turn the key on.  
4. Shift the transmission into the neutral position.  
5. Push the start switch.  
**Does the engine start?**

**NOTE:** \_\_\_\_\_  
This check is most reliable if performed with a warmed-up engine.  
\_\_\_\_\_

YES NO

The neutral switch may be defective.  
**The motorcycle should not be ridden** until checked by a Yamaha dealer.

With the engine still running:  
6. Move the sidestand up.  
7. Keep the clutch lever pulled.  
8. Shift the transmission into gear.  
9. Move the sidestand down.  
**Does the engine stall?**

YES NO

The sidestand switch may be defective.  
**The motorcycle should not be ridden** until checked by a Yamaha dealer.

After the engine has stalled:  
10. Move the sidestand up.  
11. Keep the clutch lever pulled.  
12. Push the start switch.  
**Does the engine start?**

YES NO

The clutch switch may be defective.  
**The motorcycle should not be ridden** until checked by a Yamaha dealer.

The system is OK. **The motorcycle can be ridden.**

EAU39651

## Auxiliary DC jack

This vehicle is equipped with an auxiliary DC jack in the accessory box.

A 12-V accessory connected to the auxiliary jack can be used when the key is in the "ON" position and should only be used when the engine is running.

ECA15430

### CAUTION:

**The accessory connected to the auxiliary DC jack should not be used with the engine turned off, and the load must never exceed 30 W (2.5 A), otherwise the battery may discharge.**

### To use the auxiliary DC jack

1. Open the accessory box lid. (See page 3-18.)
2. Turn the key to "OFF".
3. Remove the auxiliary DC jack cap.

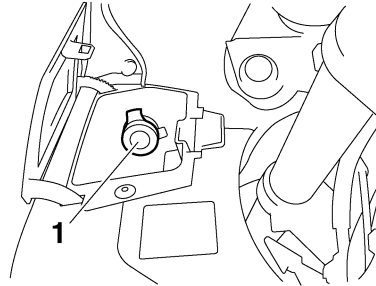

1. Auxiliary DC jack cap

4. Insert the accessory plug into the auxiliary DC jack.

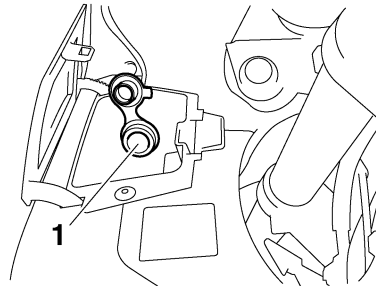

1. Auxiliary DC jack

5. Turn the key to "ON", and then start the engine. (See page 5-1.)

### WARNING

**To prevent electrical shock or short-circuiting, make sure that the cap is installed when the auxiliary DC jack is not being used.**

EWA14360

# PRE-OPERATION CHECKS

---

---

EAU15591

The condition of a vehicle is the owner's responsibility. Vital components can start to deteriorate quickly and unexpectedly, even if the vehicle remains unused (for example, as a result of exposure to the elements). Any damage, fluid leakage or loss of tire air pressure could have serious consequences. Therefore, it is very important, in addition to a thorough visual inspection, to check the following points before each ride.

## NOTE:

Pre-operation checks should be made each time the vehicle is used. Such an inspection can be accomplished in a very short time; and the added safety it assures is more than worth the time involved.

EWA11150

4

## **WARNING**

**If any item in the Pre-operation check list is not working properly, have it inspected and repaired before operating the vehicle.**

---

# PRE-OPERATION CHECKS

EAU15603

## Pre-operation check list

ITEM	CHECKS	PAGE
<b>Fuel</b>	<ul style="list-style-type: none"><li>• Check fuel level in fuel tank.</li><li>• Refuel if necessary.</li><li>• Check fuel line for leakage.</li></ul>	3-13
<b>Engine oil</b>	<ul style="list-style-type: none"><li>• Check oil level in engine.</li><li>• If necessary, add recommended oil to specified level.</li><li>• Check vehicle for oil leakage.</li></ul>	6-13
<b>Final gear oil</b>	<ul style="list-style-type: none"><li>• Check vehicle for oil leakage.</li></ul>	6-15
<b>Coolant</b>	<ul style="list-style-type: none"><li>• Check coolant level in reservoir.</li><li>• If necessary, add recommended coolant to specified level.</li><li>• Check cooling system for leakage.</li></ul>	6-17
<b>Front brake</b>	<ul style="list-style-type: none"><li>• Check operation.</li><li>• If soft or spongy, have Yamaha dealer bleed hydraulic system.</li><li>• Check brake pads for wear.</li><li>• Replace if necessary.</li><li>• Check fluid level in reservoir.</li><li>• If necessary, add recommended brake fluid to specified level.</li><li>• Check hydraulic system for leakage.</li></ul>	6-25, 6-25
<b>Rear brake</b>	<ul style="list-style-type: none"><li>• Check operation.</li><li>• If soft or spongy, have Yamaha dealer bleed hydraulic system.</li><li>• Check brake pads for wear.</li><li>• Replace if necessary.</li><li>• Check fluid level in reservoir.</li><li>• If necessary, add recommended brake fluid to specified level.</li><li>• Check hydraulic system for leakage.</li></ul>	6-25, 6-25
<b>Clutch</b>	<ul style="list-style-type: none"><li>• Check operation.</li><li>• If soft or spongy, have Yamaha dealer bleed hydraulic system.</li><li>• Check fluid level in reservoir.</li><li>• If necessary, add recommended fluid to specified level.</li><li>• Check hydraulic system for leakage.</li></ul>	6-24, 6-25

# PRE-OPERATION CHECKS

ITEM	CHECKS	PAGE
<b>Throttle grip</b>	<ul style="list-style-type: none"> <li>• Make sure that operation is smooth.</li> <li>• Check cable free play.</li> <li>• If necessary, have Yamaha dealer adjust cable free play and lubricate cable and grip housing.</li> </ul>	6-20, 6-27
<b>Control cables</b>	<ul style="list-style-type: none"> <li>• Make sure that operation is smooth.</li> <li>• Lubricate if necessary.</li> </ul>	6-27
<b>Wheels and tires</b>	<ul style="list-style-type: none"> <li>• Check for damage.</li> <li>• Check tire condition and tread depth.</li> <li>• Check air pressure.</li> <li>• Correct if necessary.</li> </ul>	6-20, 6-23
<b>Brake and shift pedals</b>	<ul style="list-style-type: none"> <li>• Make sure that operation is smooth.</li> <li>• Lubricate pedal pivoting points if necessary.</li> </ul>	6-28
<b>Brake and clutch levers</b>	<ul style="list-style-type: none"> <li>• Make sure that operation is smooth.</li> <li>• Lubricate lever pivoting points if necessary.</li> </ul>	6-28
<b>Centerstand, sidestand</b>	<ul style="list-style-type: none"> <li>• Make sure that operation is smooth.</li> <li>• Lubricate pivots if necessary.</li> </ul>	6-29
<b>Chassis fasteners</b>	<ul style="list-style-type: none"> <li>• Make sure that all nuts, bolts and screws are properly tightened.</li> <li>• Tighten if necessary.</li> </ul>	—
<b>Instruments, lights, signals and switches</b>	<ul style="list-style-type: none"> <li>• Check operation.</li> <li>• Correct if necessary.</li> </ul>	—
<b>Sidestand switch</b>	<ul style="list-style-type: none"> <li>• Check operation of ignition circuit cut-off system.</li> <li>• If system is defective, have Yamaha dealer check vehicle.</li> </ul>	3-24



# OPERATION AND IMPORTANT RIDING POINTS

EAU15950

EWA10270

EAU40280

EWA10290

ECA15500

## WARNING

- Become thoroughly familiar with all operating controls and their functions before riding. Consult a Yamaha dealer regarding any control or function that you do not thoroughly understand.
- Never start the engine or operate it in a closed area for any length of time. Exhaust fumes are poisonous, and inhaling them can cause loss of consciousness and death within a short time. Always make sure that there is adequate ventilation.
- Before starting out, make sure that the sidestand is up. If the sidestand is not raised completely, it could contact the ground and distract the operator, resulting in a possible loss of control.

## Starting the engine

In order for the ignition circuit cut-off system to enable starting, one of the following conditions must be met:

- The transmission is in the neutral position.
- The transmission is in gear with the clutch lever pulled and the sidestand up.

## WARNING

- Before starting the engine, check the function of the ignition circuit cut-off system according to the procedure described on page 3-25.
- Never ride with the sidestand down.

1. Turn the key to "ON" and make sure that the engine stop switch is set to "○".

## CAUTION:

The following warning lights should come on for a few seconds, then go off.

- Oil level warning light
- Engine trouble warning light

## ● ABS warning light

If a warning light does not go off, see page 3-2 for the corresponding warning light circuit check.

2. Shift the transmission into the neutral position.

## NOTE:

When the transmission is in the neutral position, the neutral indicator light should be on, otherwise have a Yamaha dealer check the electrical circuit.

3. Start the engine by pushing the start switch.

## NOTE:

If the engine fails to start, release the start switch, wait a few seconds, and then try again. Each starting attempt should be as short as possible to preserve the battery. Do not crank the engine more than 10 seconds on any one attempt.

# OPERATION AND IMPORTANT RIDING POINTS

ECA11130

## CAUTION:

For maximum engine life, always warm the engine up before starting off. Never accelerate hard when the engine is cold!

## NOTE:

The engine is warm when it quickly responds to the throttle.

EAU16671

## Shifting

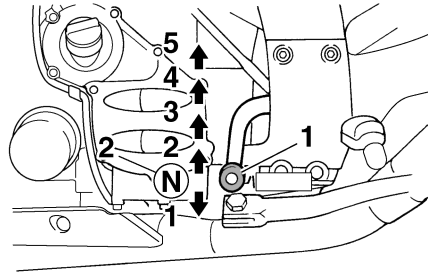

1. Shift pedal
2. Neutral position

Shifting gears lets you control the amount of engine power available for starting off, accelerating, climbing hills, etc.

The gear positions are shown in the illustration.

## NOTE:

To shift the transmission into the neutral position, press the shift pedal down repeatedly until it reaches the end of its travel, and then slightly raise it.

ECA10260

## CAUTION:

- Even with the transmission in the neutral position, do not coast for long periods of time with the engine off, and do not tow the motorcycle for long distances. The transmission is properly lubricated only when the engine is running. Inadequate lubrication may damage the transmission.
- Always use the clutch while changing gears to avoid damaging the engine, transmission, and drive train, which are not designed to withstand the shock of forced shifting.

EAU16680

## To start out and accelerate

1. Pull the clutch lever to disengage the clutch.
2. Shift the transmission into first gear. The neutral indicator light should go out.
3. Open the throttle gradually, and at the same time, release the clutch lever slowly.

# OPERATION AND IMPORTANT RIDING POINTS

4. At the recommended shift points shown in the following table, close the throttle, and at the same time, quickly pull the clutch lever in.
5. Shift the transmission into second gear. (Make sure not to shift the transmission into the neutral position.)
6. Open the throttle part way and gradually release the clutch lever.
7. Follow the same procedure when shifting to the next higher gear.

**NOTE:** \_\_\_\_\_  
Always shift gears at the recommended shift points.

EAU16700

## To decelerate

1. Apply both the front and the rear brakes to slow the motorcycle.
2. Shift the transmission into first gear when the motorcycle reaches 25 km/h (15.5 mi/h). If the engine is about to stall or runs very roughly, pull the clutch lever in and use the brakes to stop the motorcycle.

3. Shift the transmission into the neutral position when the motorcycle is almost completely stopped. The neutral indicator light should come on.

EAU16720

## Recommended shift points

The recommended shift points during acceleration and deceleration are shown in the table below.

### Shift up points:

- 1st → 2nd: 20 km/h (12.5 mi/h)
- 2nd → 3rd: 30 km/h (19 mi/h)
- 3rd → 4th: 40 km/h (25 mi/h)
- 4th → 5th: 50 km/h (31 mi/h)

### Shift down points:

- 5th → 4th: 25 km/h (15.5 mi/h)
- 4th → 3rd: 25 km/h (15.5 mi/h)
- 3rd → 2nd: 25 km/h (15.5 mi/h)
- 2nd → 1st: 25 km/h (15.5 mi/h)

EAU16841

## Engine break-in

There is never a more important period in the life of your engine than the period between 0 and 1600 km (1000 mi). For this reason, you should read the following material carefully.

Since the engine is brand new, do not put an excessive load on it for the first 1600 km (1000 mi). The various parts in the engine wear and polish themselves to the correct operating clearances. During this period, prolonged full-throttle operation or any condition that might result in engine overheating must be avoided.

EAU17121

## 0–1000 km (0–600 mi)

Avoid prolonged operation above 4500 r/min.

## 1000–1600 km (600–1000 mi)

Avoid prolonged operation above 5400 r/min.

# OPERATION AND IMPORTANT RIDING POINTS

---

ECA10331

## CAUTION:

After 1000 km (600 mi) of operation, the engine oil and final gear oil must be changed, and the oil filter cartridge or element replaced.

## 1600 km (1000 mi) and beyond

The vehicle can now be operated normally.

ECA10310

## CAUTION:

- Keep the engine speed out of the tachometer red zone.
- If any engine trouble should occur during the engine break-in period, immediately have a Yamaha dealer check the vehicle.

EAU17212

## Parking

When parking, stop the engine, and then remove the key from the main switch.

EWA10310

## WARNING

- Since the engine and exhaust system can become very hot, park in a place where pedestrians or children are not likely to touch them.
- Do not park on a slope or on soft ground, otherwise the vehicle may overturn.

ECA10380

## CAUTION:

Never park in an area where there are fire hazards such as grass or other flammable materials.

EAU17231

Safety is an obligation of the owner. Periodic inspection, adjustment and lubrication will keep your vehicle in the safest and most efficient condition possible. The most important points of motorcycle inspection, adjustment, and lubrication are explained on the following pages.

**Maintenance, replacement, or repair of the emission control devices and systems may be performed by any repair establishment or individual that is certified (if applicable).**

EWA10320

## **WARNING**

**If you are not familiar with maintenance work, have a Yamaha dealer do it for you.**

## PERIODIC MAINTENANCE

PROPER PERIODIC MAINTENANCE OF YOUR VEHICLE IS IMPORTANT IN ORDER TO ENJOY LONG, PLEASURABLE SERVICE. ESPECIALLY IMPORTANT ARE THE MAINTENANCE SERVICES RELATED TO EMISSIONS CONTROL. THESE CONTROLS NOT ONLY FUNCTION TO ENSURE CLEANER AIR, BUT ARE ALSO VITAL TO PROPER ENGINE OPERATION AND MAXIMUM PERFORMANCE. IN THE FOLLOWING PERIODIC MAINTENANCE CHARTS, THE SERVICES RELATED TO EMISSIONS CONTROL ARE GROUPED SEPARATELY. THESE SERVICES REQUIRE SPECIALIZED DATA, KNOWLEDGE, AND EQUIPMENT. YAMAHA DEALERS ARE TRAINED AND EQUIPPED TO PERFORM THESE PARTICULAR SERVICES.

EAU17301

## Owner's tool kit

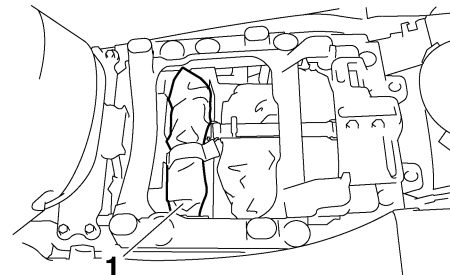

### 1. Owner's tool kit

The owner's tool kit is located under the rider seat. (See page 3-14.)

The service information included in this manual and the tools provided in the owner's tool kit are intended to assist you in the performance of preventive maintenance and minor repairs. However, additional tools such as a torque wrench may be necessary to perform certain maintenance work correctly.

### **NOTE:**

If you do not have the tools or experience required for a particular job, have a Yamaha dealer perform it for you.

# PERIODIC MAINTENANCE AND MINOR REPAIR

---

EWA10340

## **WARNING**

**Modifications not approved by Yamaha may cause loss of performance, excessive emissions, and render the vehicle unsafe for use. Consult a Yamaha dealer before attempting any changes.**

---

# PERIODIC MAINTENANCE AND MINOR REPAIR

EAU17600

## Periodic maintenance chart for the emission control system

No.	ITEM	ROUTINE	INITIAL	ODOMETER READINGS					
			600 mi (1000 km) or 1 month	4000 mi (7000 km) or 6 months	8000 mi (13000 km) or 12 months	12000 mi (19000 km) or 18 months	16000 mi (25000 km) or 24 months	20000 mi (31000 km) or 30 months	
1	* Fuel line	<ul style="list-style-type: none"> <li>Check fuel hoses for cracks or damage.</li> <li>Replace if necessary.</li> </ul>		√	√	√	√	√	
2	* Spark plugs	<ul style="list-style-type: none"> <li>Check condition.</li> <li>Adjust gap and clean.</li> <li>Replace every 8000 mi (13000 km) or 12 months.</li> </ul>		√	Replace.	√	Replace.	√	
3	* Valve clearance	<ul style="list-style-type: none"> <li>Check and adjust valve clearance when engine is cold.</li> </ul>	Every 26600 mi (42000 km)						
4	* Crankcase breather system	<ul style="list-style-type: none"> <li>Check breather hose for cracks or damage.</li> <li>Replace if necessary.</li> </ul>		√	√	√	√	√	
5	* Fuel injection	<ul style="list-style-type: none"> <li>Check and adjust engine idle speed and synchronization.</li> </ul>	√	√	√	√	√	√	
6	* Exhaust system	<ul style="list-style-type: none"> <li>Check for leakage.</li> <li>Tighten if necessary.</li> <li>Replace gasket(s) if necessary.</li> </ul>		√	√	√	√	√	
7	* Evaporative emission control system (For California only)	<ul style="list-style-type: none"> <li>Check control system for damage.</li> <li>Replace if necessary.</li> </ul>				√			
8	* Air induction system	<ul style="list-style-type: none"> <li>Check the air cut-off valve, reed valve, and hose for damage.</li> <li>Replace any damaged parts.</li> </ul>			√		√		

\* Since these items require special tools, data and technical skills, have a Yamaha dealer perform the service.

# PERIODIC MAINTENANCE AND MINOR REPAIR

EAU32183

## General maintenance and lubrication chart

No.	ITEM	ROUTINE	INITIAL	ODOMETER READINGS				
			600 mi (1000 km) or 1 month	4000 mi (7000 km) or 6 months	8000 mi (13000 km) or 12 months	12000 mi (19000 km) or 18 months	16000 mi (25000 km) or 24 months	20000 mi (31000 km) or 30 months
1	* Air filter element	<ul style="list-style-type: none"> <li>Clean with compressed air.</li> <li>Replace if necessary.</li> </ul>		√	√	√	√	√
2	* Clutch	<ul style="list-style-type: none"> <li>Check operation and fluid leakage.</li> <li>Correct if necessary.</li> </ul>	√	√	√	√	√	√
3	* Front brake	<ul style="list-style-type: none"> <li>Check operation, fluid level, and for fluid leakage.</li> <li>Replace brake pads if necessary.</li> </ul>	√	√	√	√	√	√
4	* Rear brake	<ul style="list-style-type: none"> <li>Check operation, fluid level, and for fluid leakage.</li> <li>Replace brake pads if necessary.</li> </ul>	√	√	√	√	√	√
5	* Brake hoses	<ul style="list-style-type: none"> <li>Check for cracks or damage.</li> <li>Replace.</li> </ul>		√	√	√	√	√
			Every 4 years					
6	* Wheels	<ul style="list-style-type: none"> <li>Check runout and for damage.</li> <li>Replace if necessary.</li> </ul>		√	√	√	√	√
7	* Tires	<ul style="list-style-type: none"> <li>Check tread depth and for damage.</li> <li>Replace if necessary.</li> <li>Check air pressure.</li> <li>Correct if necessary.</li> </ul>		√	√	√	√	√
8	* Wheel bearings	<ul style="list-style-type: none"> <li>Check bearings for smooth operation.</li> <li>Replace if necessary.</li> </ul>		√	√	√	√	√

6



# PERIODIC MAINTENANCE AND MINOR REPAIR

No.	ITEM	ROUTINE	INITIAL	ODOMETER READINGS					
			600 mi (1000 km) or 1 month	4000 mi (7000 km) or 6 months	8000 mi (13000 km) or 12 months	12000 mi (19000 km) or 18 months	16000 mi (25000 km) or 24 months	20000 mi (31000 km) or 30 months	
9	* Swingarm pivot bearings	<ul style="list-style-type: none"> <li>• Check bearing assemblies for looseness.</li> <li>• Moderately repack with lithium-soap-based grease.</li> </ul>			√			Repack.	
10	* Steering bearings	<ul style="list-style-type: none"> <li>• Check bearing assemblies for looseness.</li> <li>• Moderately repack with lithium-soap-based grease every 16000 mi (25000 km) or 24 months.</li> </ul>	√	√	√	√	Repack.	√	
11	* Chassis fasteners	<ul style="list-style-type: none"> <li>• Check all chassis fitting and fasteners.</li> <li>• Correct if necessary.</li> </ul>		√	√	√	√	√	
12	Brake and clutch lever pivot shafts	<ul style="list-style-type: none"> <li>• Apply lithium-soap-based grease (all-purpose grease) lightly.</li> </ul>		√	√	√	√	√	
13	Brake and shift pedal pivot shafts	<ul style="list-style-type: none"> <li>• Apply lithium-soap-based grease (all-purpose grease) lightly.</li> </ul>		√	√	√	√	√	
14	* Centerstand and sidestand pivots	<ul style="list-style-type: none"> <li>• Check operation.</li> <li>• Apply lithium-soap-based grease (all-purpose grease) lightly.</li> </ul>		√	√	√	√	√	
15	* Sidestand switch	<ul style="list-style-type: none"> <li>• Check operation and replace if necessary.</li> </ul>	√	√	√	√	√	√	
16	* Front fork	<ul style="list-style-type: none"> <li>• Check operation and for oil leakage.</li> <li>• Replace if necessary.</li> </ul>		√	√	√	√	√	
17	* Shock absorber assembly	<ul style="list-style-type: none"> <li>• Check operation and for oil leakage.</li> <li>• Replace if necessary.</li> </ul>		√	√	√	√	√	

# PERIODIC MAINTENANCE AND MINOR REPAIR

No.	ITEM	ROUTINE	INITIAL	ODOMETER READINGS				
			600 mi (1000 km) or 1 month	4000 mi (7000 km) or 6 months	8000 mi (13000 km) or 12 months	12000 mi (19000 km) or 18 months	16000 mi (25000 km) or 24 months	20000 mi (31000 km) or 30 months
18	* Rear suspension link pivots	<ul style="list-style-type: none"> <li>Apply lithium-soap-based grease lightly.</li> </ul>					√	
19	Engine oil	<ul style="list-style-type: none"> <li>Change (warm engine before draining).</li> </ul>	√	√	√	√	√	√
20	* Engine oil filter cartridge	<ul style="list-style-type: none"> <li>Replace.</li> </ul>	√		√		√	
21	* Cooling system	<ul style="list-style-type: none"> <li>Check hoses for cracks or damage.</li> <li>Replace if necessary.</li> </ul>		√	√	√	√	√
		<ul style="list-style-type: none"> <li>Change with ethylene glycol anti-freeze coolant every 24 months.</li> </ul>					Change.	
22	* Final gear oil	<ul style="list-style-type: none"> <li>Check oil level and for leakage.</li> <li>Change at initial 600 mi (1000 km) or 1 month, and thereafter every 16000 mi (25000 km) or 24 months.</li> </ul>	Change.		√		Change.	
23	* Front and rear brake switches	<ul style="list-style-type: none"> <li>Check operation.</li> </ul>	√	√	√	√	√	√
24	* Control cables	<ul style="list-style-type: none"> <li>Apply Yamaha chain and cable lube or engine oil SAE 10W-30 thoroughly.</li> </ul>	√	√	√	√	√	√
25	* Throttle grip housing and cable	<ul style="list-style-type: none"> <li>Check operation and free play.</li> <li>Adjust the throttle cable free play if necessary.</li> <li>Lubricate the throttle grip housing and cable.</li> </ul>		√	√	√	√	√

# PERIODIC MAINTENANCE AND MINOR REPAIR

No.	ITEM	ROUTINE	INITIAL	ODOMETER READINGS					
			600 mi (1000 km) or 1 month	4000 mi (7000 km) or 6 months	8000 mi (13000 km) or 12 months	12000 mi (19000 km) or 18 months	16000 mi (25000 km) or 24 months	20000 mi (31000 km) or 30 months	
26	* Lights, signals and switches	<ul style="list-style-type: none"> <li>• Check operation.</li> <li>• Adjust headlight beam.</li> </ul>	√	√	√	√	√	√	

\* Since these items require special tools, data and technical skills, have a Yamaha dealer perform the service.

**NOTE:**

From 24000 mi (37000 km) or 36 months, repeat the maintenance intervals starting from 8000 mi (13000 km) or 12 months.

EAU17660

**NOTE:**

- The air filter needs more frequent service if you are riding in unusually wet or dusty areas.
- Hydraulic brake and clutch systems
  - After disassembling the brake or clutch master cylinders, caliper cylinders or clutch release cylinder, always change the fluid. Regularly check the brake and clutch fluid levels and fill the reservoirs as required.
  - Replace the oil seals on the inner parts of the brake or clutch master cylinders, caliper cylinders and clutch release cylinder every two years.
  - Replace the brake and clutch hoses every four years or if cracked or damaged.

# PERIODIC MAINTENANCE AND MINOR REPAIR

## Removing and installing panels

EAU18771

The panels shown need to be removed to perform some of the maintenance jobs described in this chapter. Refer to this section each time a panel needs to be removed and installed.

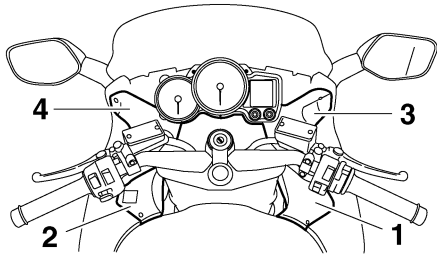

1. Panel A
2. Panel B
3. Panel C
4. Panel D

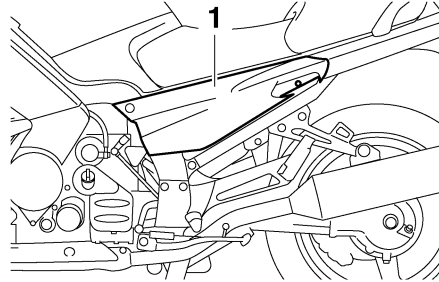

1. Panel E

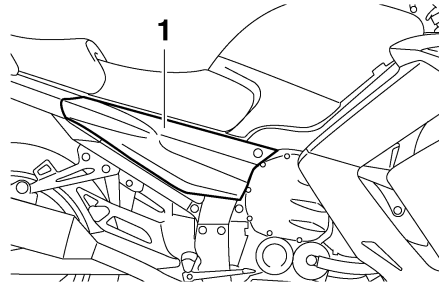

1. Panel F

### Panel A

EAU39550

#### To remove the panel

Remove the bolts and the quick fastener, and then take the panel off.

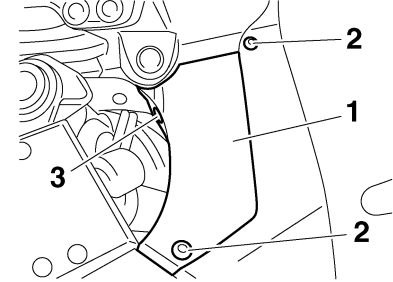

1. Panel A
2. Bolt
3. Quick fastener

#### To install the panel

Place the panel in the original position, and then install the bolts and the quick fastener.

### Panel B

EAU39562

#### To remove the panel

1. Open the accessory box lid. (See page 3-18.)
2. Remove the bolt, screw and the quick fasteners shown, and then take the panel off.

# PERIODIC MAINTENANCE AND MINOR REPAIR

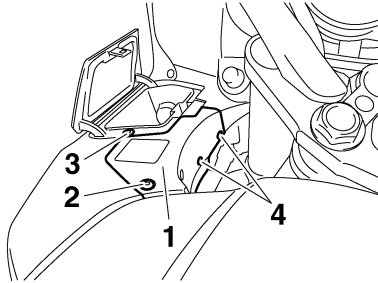

1. Panel B
2. Bolt
3. Screw
4. Quick fastener

## To install the panel

1. Place the panel in the original position, and then install the bolt, screw and the quick fasteners.
2. Close the accessory box lid.

## Panel C

EAU39570

## To remove the panel

1. Remove panel A. (See page 6-8.)
2. Remove the bolt and quick fastener, and then remove the panel.

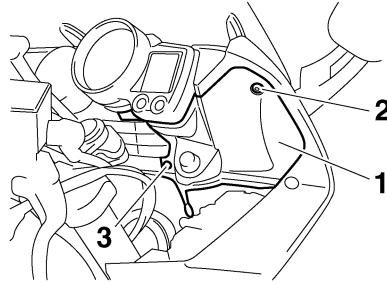

1. Panel C
2. Bolt
3. Quick fastener

## **CAUTION:**

**Do not remove the headlight beam adjusting cable.**

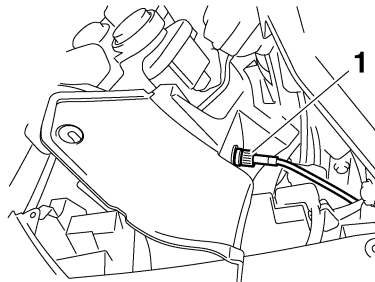

1. Headlight beam adjusting cable

## To install the panel

1. Place the panel in the original position, and then install the bolt and quick fastener.

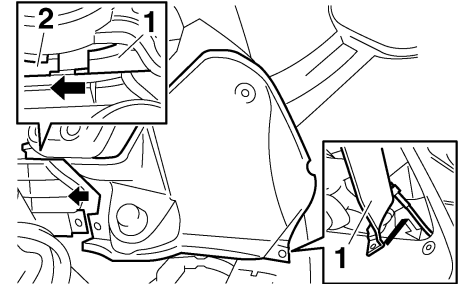

1. Panel C
2. Panel D

2. Install the panel.

## Panel D

EAU39582

## To remove the panel

1. Remove panels B and C. (See page 6-8.)
2. Remove the bolts and quick fastener shown, and then remove the panel.

# PERIODIC MAINTENANCE AND MINOR REPAIR

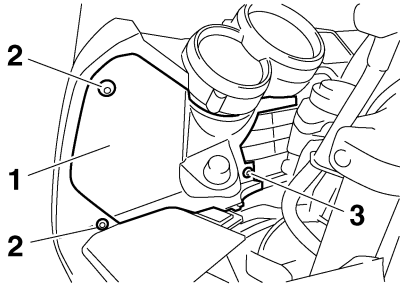

1. Panel D
2. Bolt
3. Quick fastener

ECA15420

## CAUTION:

6

**Do not remove the headlight beam adjusting cable.**

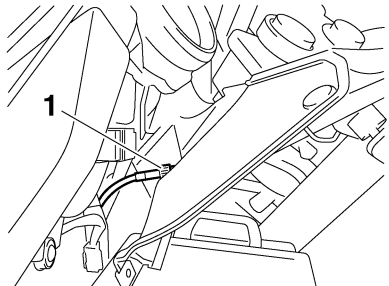

1. Headlight beam adjusting cable

## To install the panel

1. Place the panel in the original position, and then install the bolts and quick fastener.

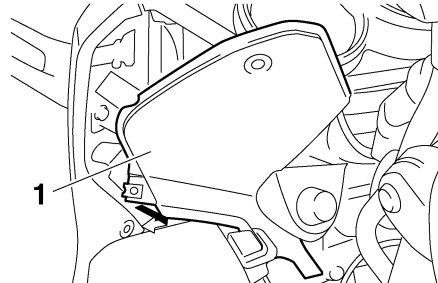

1. Panel D
2. Install panels B and C.

## Panel E

## To remove the panel

1. Remove the seats. (See page 3-14.)
2. Remove the bolts and the quick fastener screws, and then take the panel off.

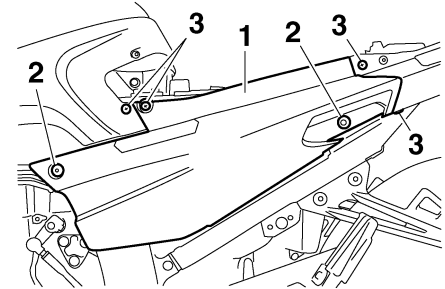

1. Panel E
2. Bolt
3. Quick fastener screw

## To install the panel

1. Place the panel in the original position, and then install the bolts and the quick fastener screws.

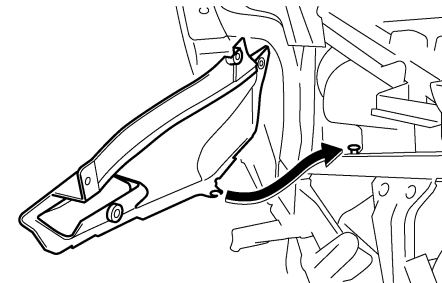

2. Install the seats.

## Panel F

EAU39601

### To remove the panel

1. Remove the seats. (See page 3-14.)
2. Remove the bolt and the quick fastener screws, and then take the panel off.

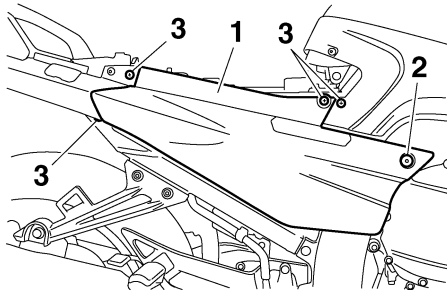

1. Panel F
2. Bolt
3. Quick fastener screw

### To install the panel

1. Place the panel in the original position, and then install the bolt and the quick fastener screws.

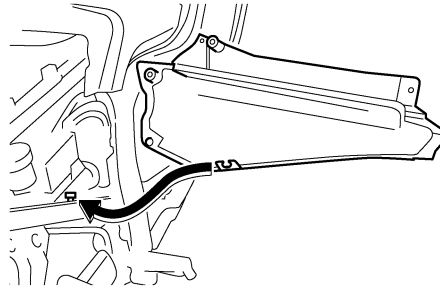

2. Install the seats.

EAU19642

## Checking the spark plugs

The spark plugs are important engine components, which should be checked periodically, preferably by a Yamaha dealer. Since heat and deposits will cause any spark plug to slowly erode, they should be removed and checked in accordance with the periodic maintenance and lubrication chart. In addition, the condition of the spark plugs can reveal the condition of the engine.

The porcelain insulator around the center electrode of each spark plug should be a medium-to-light tan (the ideal color when the vehicle is ridden normally), and all spark plugs installed in the engine should have the same color. If any spark plug shows a distinctly different color, the engine could be operating improperly. Do not attempt to diagnose such problems yourself. Instead, have a Yamaha dealer check the vehicle.

If a spark plug shows signs of electrode erosion and excessive carbon or other deposits, it should be replaced.

# PERIODIC MAINTENANCE AND MINOR REPAIR

**Specified spark plug:**  
NGK/CR8E  
DENSO/U24ESR-N

Before installing a spark plug, the spark plug gap should be measured with a wire thickness gauge and, if necessary, adjusted to specification.

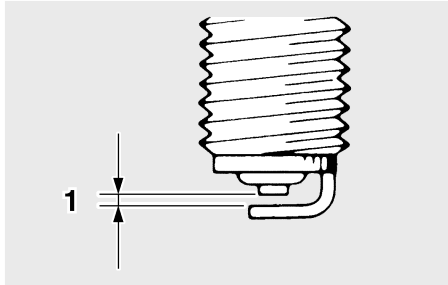

1. Spark plug gap

**Spark plug gap:**  
0.7–0.8 mm (0.028–0.031 in)

Clean the surface of the spark plug gasket and its mating surface, and then wipe off any grime from the spark plug threads.

**Tightening torque:**  
Spark plug:  
12.5 Nm (1.25 m·kgf, 9.0 ft·lbf)

**NOTE:** \_\_\_\_\_  
If a torque wrench is not available when installing a spark plug, a good estimate of the correct torque is 1/4–1/2 turn past finger tight. However, the spark plug should be tightened to the specified torque as soon as possible.

## Canister (for California only) EAU19681

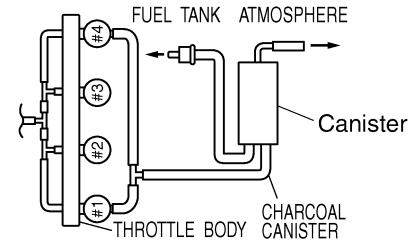

This model is equipped with a canister to prevent the discharging of fuel vapor into the atmosphere. Before operating this vehicle, make sure to check the following:

- Check each hose connection.
- Check each hose and canister for cracks or damage. Replace if damaged.
- Make sure that the canister breather is not blocked, and if necessary, clean it.



# PERIODIC MAINTENANCE AND MINOR REPAIR

EAU19881

## Engine oil and oil filter cartridge

The engine oil level should be checked before each ride. In addition, the oil must be changed and the oil filter cartridge replaced at the intervals specified in the periodic maintenance and lubrication chart.

### To check the engine oil level

1. Place the vehicle on the center-stand.

#### NOTE:

Make sure that the vehicle is positioned straight up when checking the oil level. A slight tilt to the side can result in a false reading.

2. Start the engine, warm it up for several minutes, and then turn it off.
3. Wait a few minutes until the oil settles, and then check the oil level through the check window located at the bottom-left side of the crankcase.

**NOTE:** \_\_\_\_\_  
The engine oil should be between the minimum and maximum level marks.

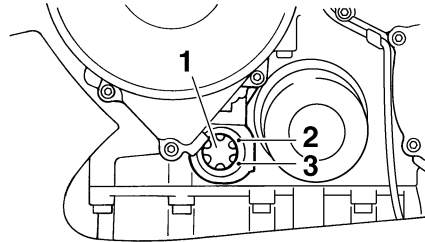

1. Engine oil level check window
  2. Maximum level mark
  3. Minimum level mark
4. If the engine oil is below the minimum level mark, add sufficient oil of the recommended type to raise it to the correct level.

### To change the engine oil (with or without oil filter cartridge replacement)

1. Start the engine, warm it up for several minutes, and then turn it off.

2. Place an oil pan under the engine to collect the used oil.
3. Remove the engine oil filler cap and drain bolt to drain the oil from the crankcase.

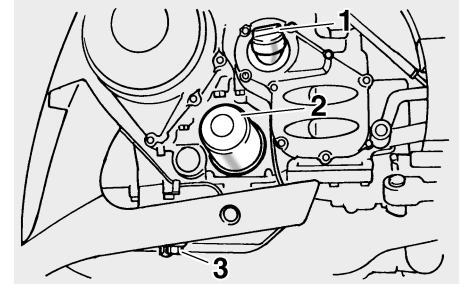

1. Engine oil filler cap
2. Oil filter cartridge
3. Engine oil drain bolt

#### NOTE:

Skip steps 4–6 if the oil filter cartridge is not being replaced.

4. Remove the oil filter cartridge with an oil filter wrench.

# PERIODIC MAINTENANCE AND MINOR REPAIR

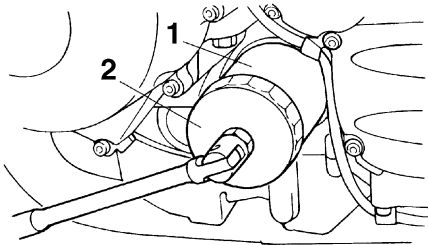

1. Oil filter cartridge
2. Oil filter wrench

**NOTE:** \_\_\_\_\_  
An oil filter wrench is available at a Yamaha dealer.

5. Apply a thin coat of engine oil to the O-ring of the new oil filter cartridge.

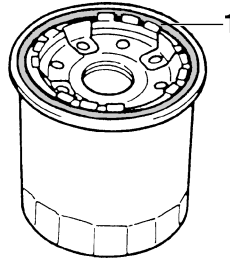

1. O-ring

**NOTE:** \_\_\_\_\_  
Make sure that the O-ring is properly seated.

6. Install the new oil filter cartridge, and then tighten it to the specified torque with a torque wrench.

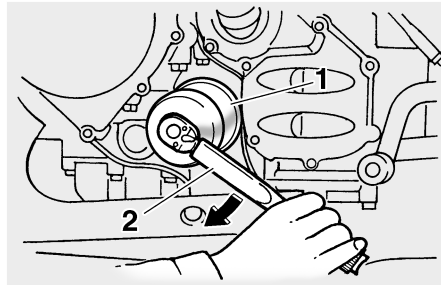

1. Oil filter cartridge
2. Torque wrench

## Tightening torque:

Oil filter cartridge:  
17 Nm (1.7 m·kgf, 12 ft·lbf)

7. Install the engine oil drain bolt, and then tighten it to the specified torque.

**NOTE:** \_\_\_\_\_  
Check the washer for damage and replace it if necessary.

## Tightening torque:

Engine oil drain bolt:  
43 Nm (4.3 m·kgf, 31 ft·lbf)

8. Add the specified amount of the recommended engine oil, and then install and tighten the oil filler cap.

## Recommended engine oil:

See page 8-1.

## Oil quantity:

Without oil filter cartridge replacement:

3.80 L (4.02 US qt) (3.34 Imp.qt)

With oil filter cartridge replacement:

4.00 L (4.23 US qt) (3.52 Imp.qt)

# PERIODIC MAINTENANCE AND MINOR REPAIR

ECA11620

## CAUTION:

- In order to prevent clutch slippage (since the engine oil also lubricates the clutch), do not mix any chemical additives. Do not use oils with a diesel specification of “CD” or oils of a higher quality than specified. In addition, do not use oils labeled “ENERGY CONSERVING II” or higher.
- Make sure that no foreign material enters the crankcase.

9. Start the engine, and then let it idle for several minutes while checking it for oil leakage. If oil is leaking, immediately turn the engine off and check for the cause.

## NOTE:

After the engine is started, the engine oil level warning light should go off if the oil level is sufficient.

ECA10400

## CAUTION:

If the oil level warning light flickers or remains on, immediately turn the engine off and have a Yamaha dealer check the vehicle.

10. Turn the engine off, and then check the oil level and correct it if necessary.

EAU20011

## Final gear oil

The final gear case must be checked for oil leakage before each ride. If any leakage is found, have a Yamaha dealer check and repair the vehicle. In addition, the final gear oil must be changed as follows at the intervals specified in the periodic maintenance and lubrication chart.

EWA10370

## WARNING

- Make sure that no foreign material enters the final gear case.
- Make sure that no oil gets on the tire or wheel.

## To check the final gear oil level

1. Place the vehicle on the center-stand.

## NOTE:

- The final gear oil level must be checked on a cold engine.
- Make sure that the vehicle is positioned straight up when checking the oil level. A slight tilt to the side can result in a false reading.

# PERIODIC MAINTENANCE AND MINOR REPAIR

2. Remove the oil filler bolt, and then check the oil level in the final gear case.

## NOTE:

The oil level should be at the brim of the filler hole.

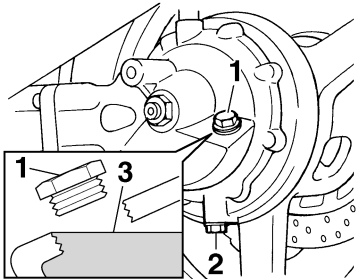

1. Final gear oil filler bolt
  2. Final gear oil drain bolt
  3. Correct oil level
3. If the oil is below the brim of the filler hole, add sufficient oil of the recommended type to raise it to the correct level.
  4. Install the oil filler bolt, and then tighten it to the specified torque.

## Tightening torque:

Final gear oil filler bolt:  
23 Nm (2.3 m-kgf, 17 ft-lbf)

## Tightening torque:

Final gear oil filler bolt:  
23 Nm (2.3 m-kgf, 17 ft-lbf)

## To change the final gear oil

1. Place an oil pan under the final gear case to collect the used oil.
2. Remove the oil filler bolt and drain bolt to drain the oil from the final gear case.
3. Install the final gear oil drain bolt, and then tighten it to the specified torque.

## Tightening torque:

Final gear oil drain bolt:  
23 Nm (2.3 m-kgf, 17 ft-lbf)

4. Add the recommended final gear oil to the brim of the filler hole.

## Recommended final gear oil:

Shaft drive gear oil (Part No.: 9079E-SH001-00)

## Oil quantity:

0.20 L (0.21 US qt) (0.18 Imp.qt)

5. Install the oil filler bolt, and then tighten it to the specified torque.

6. Check the final gear case for oil leakage. If oil is leaking, check for the cause.

# PERIODIC MAINTENANCE AND MINOR REPAIR

## Coolant

EAU20070

The coolant level should be checked before each ride. In addition, the coolant must be changed at the intervals specified in the periodic maintenance and lubrication chart.

### To check the coolant level

EAU39510

The coolant level should be checked as follows before each ride. In addition, the coolant must be changed at the intervals specified in the periodic maintenance and lubrication chart.

1. Place the vehicle on the center-stand.

### NOTE:

- The coolant level must be checked on a cold engine since the level varies with engine temperature.
- Make sure that the vehicle is positioned straight up when checking the coolant level. A slight tilt to the side can result in a false reading.

2. Check the coolant level in the coolant reservoir.

### NOTE:

The coolant should be between the minimum and maximum level marks.

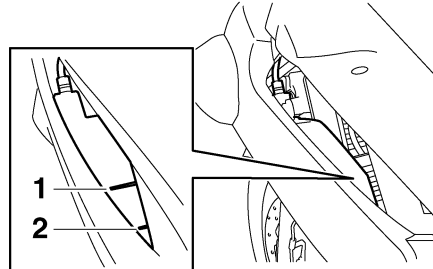

1. Maximum level mark
2. Minimum level mark

3. If the coolant is at or below the minimum level mark, remove the reservoir cap.

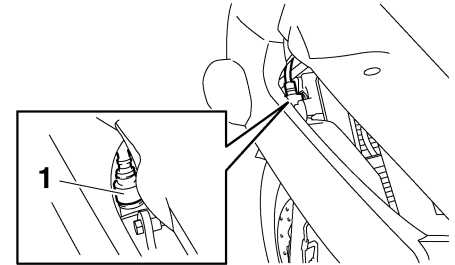

1. Coolant reservoir cap

4. Add coolant or distilled water to raise the coolant to the maximum level mark, install the coolant reservoir cap.

**Coolant reservoir capacity (up to the maximum level mark):**  
0.25 L (0.26 US qt) (0.22 Imp.qt)

ECA10470

### CAUTION:

- If coolant is not available, use distilled water or soft tap water instead. Do not use hard water or salt water since it is harmful to the engine.
- If water has been used instead of coolant, replace it with coolant as soon as possible, other-

# PERIODIC MAINTENANCE AND MINOR REPAIR

wise the engine may not be sufficiently cooled and the cooling system will not be protected against frost and corrosion.

- If water has been added to the coolant, have a Yamaha dealer check the antifreeze content of the coolant as soon as possible, otherwise the effectiveness of the coolant will be reduced.

## **WARNING**

EWA10380

Never attempt to remove the radiator cap when the engine is hot.

6

## NOTE:

- The radiator fans are automatically switched on or off according to the coolant temperature in the radiator.
- If the engine overheats, see page 6-38 for further instructions.

## Changing the coolant

EAU33030

EWA10380

## **WARNING**

Never attempt to remove the radiator cap when the engine is hot.

The coolant must be changed at the intervals specified in the periodic maintenance and lubrication chart. Have a Yamaha dealer change the coolant.

## Cleaning the air filter element

EAU20471

The air filter element should be cleaned at the intervals specified in the periodic maintenance and lubrication chart. Clean the air filter element more frequently if you are riding in unusually wet or dusty areas.

1. Remove panel E. (See page 6-8.)
2. Remove the intake air shroud by removing the screw and the quick fastener screws.

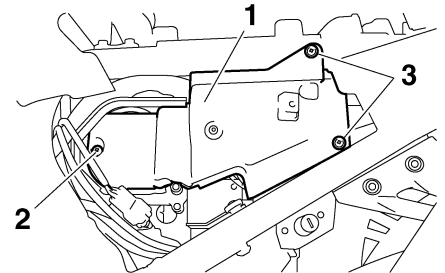

1. Intake air shroud
2. Screw
3. Quick fastener screw

3. Remove the air filter case cover by removing the screws.

# PERIODIC MAINTENANCE AND MINOR REPAIR

ECA15410

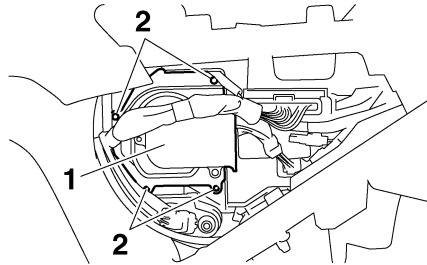

1. Air filter case cover
2. Screw

4. Pull the air filter element out.

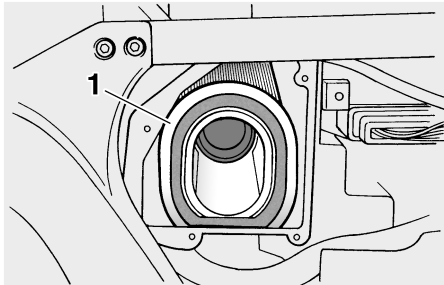

1. Air filter element

5. Lightly tap the air filter element to remove most of the dust and dirt, and then blow the remaining dirt

out with compressed air as shown. If the air filter element is damaged, replace it.

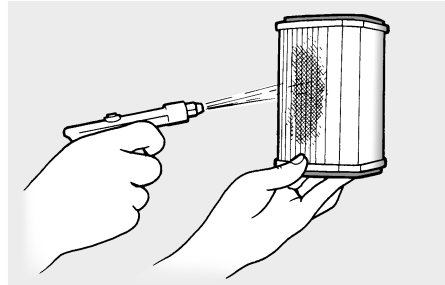

6. Insert the air filter element into the air filter case.

ECA10480

**CAUTION:**

- Make sure that the air filter element is properly seated in the air filter case.
- The engine should never be operated without the air filter element installed, otherwise the piston(s) and/or cylinder(s) may become excessively worn.

7. Install the air filter case cover by installing the screws.

**CAUTION:**

Make sure that the fuel tank breather/overflow hose is not pinched.

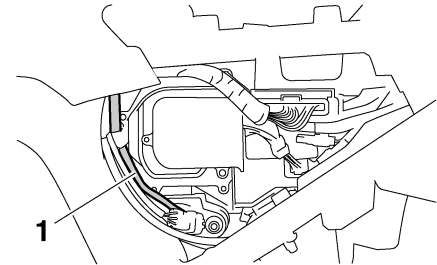

1. Fuel tank breather/overflow hose

8. Install the intake air shroud by installing the screw and the quick fastener screws.
9. Install the panel.

# PERIODIC MAINTENANCE AND MINOR REPAIR

## Checking the throttle cable free play

EAU21381

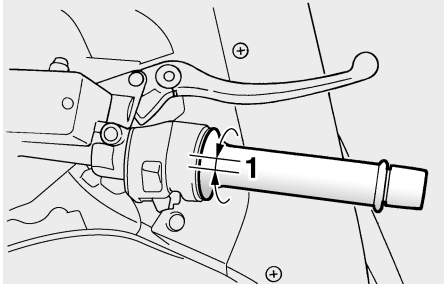

### 1. Throttle cable free play

The throttle cable free play should measure 3.0–5.0 mm (0.12–0.20 in) at the throttle grip. Periodically check the throttle cable free play and, if necessary, have a Yamaha dealer adjust it.

6

## Valve clearance

EAU21401

The valve clearance changes with use, resulting in improper air-fuel mixture and/or engine noise. To prevent this from occurring, the valve clearance must be adjusted by a Yamaha dealer at the intervals specified in the periodic maintenance and lubrication chart.

## Tires

EAU21750

To maximize the performance, durability, and safe operation of your motorcycle, note the following points regarding the specified tires.

### Tire air pressure

The tire air pressure should be checked and, if necessary, adjusted before each ride.

EWA10500

### **⚠ WARNING**

- The tire air pressure must be checked and adjusted on cold tires (i.e., when the temperature of the tires equals the ambient temperature).
- The tire air pressure must be adjusted in accordance with the riding speed and with the total weight of rider, passenger, cargo, and accessories approved for this model.



# PERIODIC MAINTENANCE AND MINOR REPAIR

**Tire air pressure (measured on cold tires):**

**0–90 kg (0–198 lb):**

Front:

270 kPa (39 psi) (2.70 kgf/cm<sup>2</sup>)

Rear:

290 kPa (42 psi) (2.90 kgf/cm<sup>2</sup>)

**90–211 kg (198–465 lb) (CAL)**

**90–212 kg (198–467 lb) (U49):**

Front:

270 kPa (39 psi) (2.70 kgf/cm<sup>2</sup>)

Rear:

290 kPa (42 psi) (2.90 kgf/cm<sup>2</sup>)

**High-speed riding:**

Front:

270 kPa (39 psi) (2.70 kgf/cm<sup>2</sup>)

Rear:

290 kPa (42 psi) (2.90 kgf/cm<sup>2</sup>)

**Maximum load\*:**

211 kg (465 lb) (CAL)

212 kg (467 lb) (U49)

\* Total weight of rider, passenger, cargo and accessories

EWA10510



**WARNING**

Proper loading of your vehicle is important for several characteristics of your vehicle, such as handling, braking, performance and safety. Do not carry loosely packed items that can shift. Securely pack your heavi-

est items close to the center of the vehicle, and distribute the weight evenly from side to side. Properly adjust the suspension for your load, and check the condition and pressure of your tires. **NEVER OVERLOAD YOUR VEHICLE.** Make sure that the total weight of the cargo, rider, passenger, and accessories (cowling, saddlebags, etc. if approved for this model) does not exceed the maximum load of the vehicle. Operation of an overloaded vehicle could cause tire damage, an accident, or even injury.

**Tire inspection**

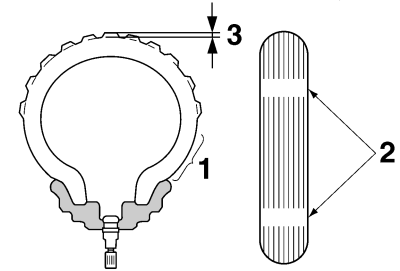

1. Tire sidewall
2. Tire wear indicator
3. Tire tread depth

Always check the tires before operating the motorcycle. If a tire tread shows crosswise lines (minimum tread depth), if the tire has a nail or glass fragments in it, or if the sidewall is cracked, contact a Yamaha dealer immediately and have the tire replaced.

**Minimum tire tread depth (front and rear):**

1.0 mm (0.04 in)

# PERIODIC MAINTENANCE AND MINOR REPAIR

## ⚠ WARNING

EWA10580

- It is dangerous to ride with a worn-out tire. When a tire tread begins to show crosswise lines, have a Yamaha dealer replace the tire immediately.
- The replacement of all wheel- and brake-related parts, including the tires, should be left to a Yamaha dealer, who has the necessary professional knowledge and experience.

This motorcycle is equipped with cast wheels and tubeless tires with valves.

EWA10480

## ⚠ WARNING

- The front and rear tires should be of the same make and design, otherwise the handling characteristics of the motorcycle cannot be guaranteed.
- After extensive tests, only the tires listed below have been approved for this model by Yamaha Motor Co., Ltd.
- Always make sure that the valve caps are securely installed to prevent air pressure leakage.
- Use only the tire valves and valve cores listed below to avoid tire deflation during a high-speed ride.

### Front tire:

Size:

120/70 ZR17M/C (58W)

Manufacturer/model:

METZELER/Roadtec Z6G  
BRIDGESTONE/BT020F

### Rear tire:

Size:

180/55 ZR17M/C (73W)

Manufacturer/model:

METZELER/Roadtec Z6C  
BRIDGESTONE/BT020R

### FRONT and REAR:

Tire air valve:

TR412

Valve core:

#9100 (original)

EWA10600

## ⚠ WARNING

This motorcycle is fitted with super-high-speed tires. Note the following points in order to make the most efficient use of these tires.

- Use only the specified replacement tires. Other tires may run the danger of bursting at super high speeds.
- Brand-new tires can have a relatively poor grip on certain road surfaces until they have been

6

## Tire information

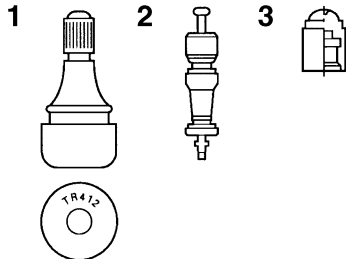

1. Tire air valve
2. Tire air valve core
3. Tire air valve cap with seal

# PERIODIC MAINTENANCE AND MINOR REPAIR

“broken in”. Therefore, it is advisable before doing any high-speed riding to ride conservatively for approximately 100 km (60 mi) after installing a new tire.

- The tires must be warmed up before a high-speed run.
- Always adjust the tire air pressure according to the operating conditions.

## Cast wheels

To maximize the performance, durability, and safe operation of your vehicle, note the following points regarding the specified wheels.

- The wheel rims should be checked for cracks, bends or warpage before each ride. If any damage is found, have a Yamaha dealer replace the wheel. Do not attempt even the smallest repair to the wheel. A deformed or cracked wheel must be replaced.
- The wheel should be balanced whenever either the tire or wheel has been changed or replaced. An unbalanced wheel can result in poor performance, adverse handling characteristics, and a shortened tire life.
- Ride at moderate speeds after changing a tire since the tire surface must first be “broken in” for it to develop its optimal characteristics.

## Accessories and replacement parts



This vehicle is not designed to pull a trailer or to be attached to a sidecar. The accessories or replacement parts you choose for your vehicle should be designed specifically for this model, and they must be securely mounted to maintain the inherent stability of the original design. Genuine Yamaha Parts and Accessories are designed and tested to be compatible with your vehicle. Please consider Genuine Yamaha Parts and Accessories before making a purchase. Use of non-Yamaha-approved accessories or replacement parts may cause loss of handling stability and riding safety. Since Yamaha cannot control the quality of accessories or parts manufactured by other companies, Yamaha cannot be held liable for

# PERIODIC MAINTENANCE AND MINOR REPAIR

---

any consequences caused by the use of items which have not been approved by Yamaha.

---

EAU22072

## Clutch lever

Since this model is equipped with a hydraulic clutch, adjusting the clutch lever free play is not needed. However, it is necessary to check the clutch fluid level and check the hydraulic system for leakage before each ride. If the clutch lever free play does become excessive, and shifting becomes rough or clutch slippage occurs, causing poor acceleration, there may be air in the clutch system. If there is air in the hydraulic system, have a Yamaha dealer bleed the system before operating the motorcycle.

EAU36500

## Adjusting the rear brake light switch

The rear brake light switch, which is activated by the brake pedal, is properly adjusted when the brake light comes on just before braking takes effect. If necessary, have a Yamaha dealer adjust the brake light switch.

## Checking the front and rear brake pads

EAU22390

The front and rear brake pads must be checked for wear at the intervals specified in the periodic maintenance and lubrication chart.

### Front brake pads

EAU22420

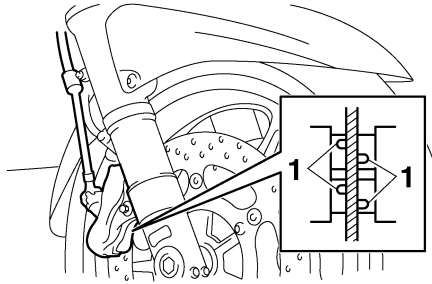

1. Brake pad wear indicator groove

Each front brake pad is provided with a wear indicator groove, which allows you to check the brake pad wear without having to disassemble the brake. To check the brake pad wear, check the wear indicator groove. If a brake pad has worn to the point that the wear

indicator groove has almost disappeared, have a Yamaha dealer replace the brake pads as a set.

### Rear brake pads

EAU22500

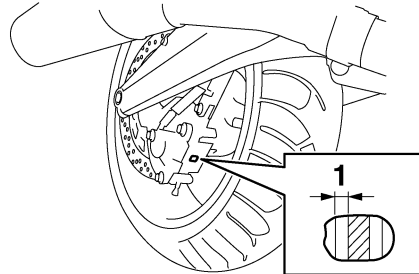

1. Lining thickness

Check each rear brake pad for damage and measure the lining thickness. If a brake pad is damaged or if the lining thickness is less than 0.8 mm (0.03 in), have a Yamaha dealer replace the brake pads as a set.

## Checking the brake and clutch fluid levels

EAU40270

### Front brake

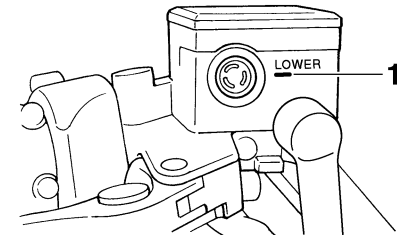

1. Minimum level mark

### Rear brake

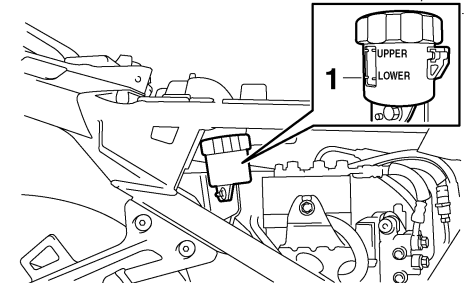

1. Minimum level mark

# PERIODIC MAINTENANCE AND MINOR REPAIR

## Clutch

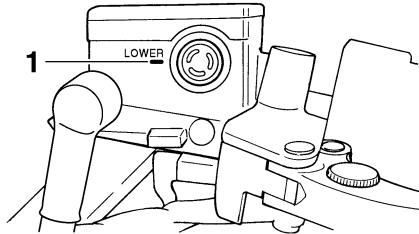

1. Minimum level mark

Insufficient brake fluid may allow air to enter the brake or clutch systems, possibly causing them to become ineffective.

Before riding, check that the brake fluid is above the minimum level mark and replenish if necessary. A low brake fluid level may indicate worn brake pads and/or brake system leakage. If the brake level is low, be sure to check the brake pads for wear and the brake system for leakage.

### NOTE:

The rear brake fluid reservoir is located behind panel F. (See page 6-8.)

Observe these precautions:

- When checking the fluid level, make sure that the top of the brake or clutch fluid reservoir is level.
- Use only the recommended quality brake fluid, otherwise the rubber seals may deteriorate, causing leakage and poor braking or clutch performance.

**Recommended brake and clutch fluid:**  
DOT 4 brake fluid

- Refill with the same type of brake fluid. Mixing fluids may result in a harmful chemical reaction and lead to poor braking or clutch performance.
- The brake or clutch fluid reservoir diaphragm will lose its shape from the negative pressure if the fluid level goes down too far. Be sure to return the diaphragm to its original shape before installing it into the brake or clutch fluid reservoir.
- Be careful that water or dust does not enter the brake or clutch fluid reservoir when refilling. Water will significantly lower the boiling point

of the fluid and may result in vapor lock, and dirt may clog the ABS hydraulic unit valves.

- Brake fluid may deteriorate painted surfaces or plastic parts. Always clean up spilled fluid immediately.
- As the brake pads wear, it is normal for the brake fluid level to gradually go down. However, if the brake fluid level goes down suddenly, have a Yamaha dealer check the cause.

# PERIODIC MAINTENANCE AND MINOR REPAIR

## Changing the brake and clutch fluids

EAU22750

Have a Yamaha dealer change the brake and clutch fluids at the intervals specified in the NOTE after the periodic maintenance and lubrication chart. In addition, have the oil seals of the brake and clutch master cylinders and calipers as well as the brake and clutch hoses replaced at the intervals listed below or whenever they are damaged or leaking.

- Oil seals: Replace every two years.
- Brake and clutch hoses: Replace every four years.

## Checking and lubricating the cables

EAU23090

The operation of all control cables and the condition of the cables should be checked before each ride, and the cables and cable ends should be lubricated if necessary. If a cable is damaged or does not move smoothly, have a Yamaha dealer check or replace it.

### Recommended lubricant:

Yamaha Chain and Cable Lube or engine oil SAE 10W-30 (API SE)

EWA10710

### **WARNING**

**Damage to the outer housing of cables may result in internal rusting and cause interference with cable movement. Replace damaged cables as soon as possible to prevent unsafe conditions.**

## Checking and lubricating the throttle grip and cable

EAU23111

The operation of the throttle grip should be checked before each ride. In addition, the cable should be lubricated at the intervals specified in the periodic maintenance chart.

# PERIODIC MAINTENANCE AND MINOR REPAIR

## Checking and lubricating the brake and shift pedals

EAU23131

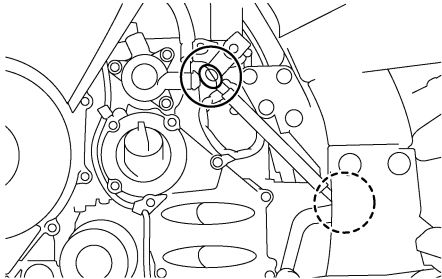
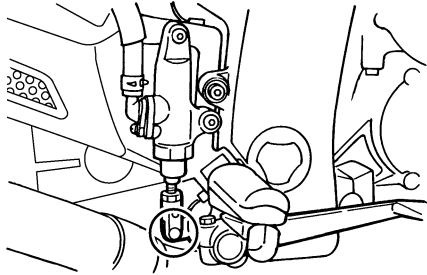

The operation of the brake and shift pedals should be checked before each ride, and the pedal pivots should be lubricated if necessary.

**Recommended lubricant:**  
Lithium-soap-based grease (all-purpose grease)

## Checking and lubricating the brake and clutch levers

EAU23140

### Brake lever

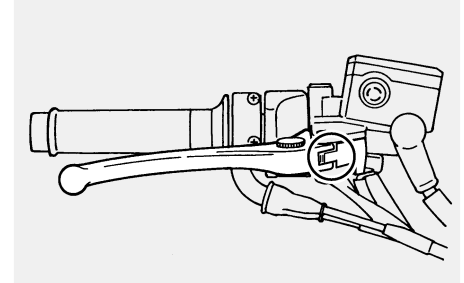

### Clutch lever

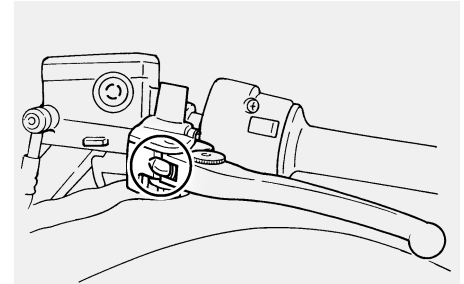

The operation of the brake and clutch levers should be checked before each ride, and the lever pivots should be lubricated if necessary.



# PERIODIC MAINTENANCE AND MINOR REPAIR

## Recommended lubricant:

Lithium-soap-based grease (all-purpose grease)

## Checking and lubricating the centerstand and sidestand

EAU23211

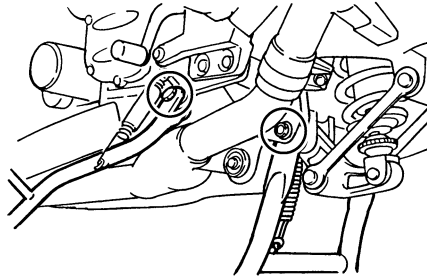

The operation of the centerstand and sidestand should be checked before each ride, and the pivots and metal-to-metal contact surfaces should be lubricated if necessary.

EWA10740

## **⚠ WARNING**

If the centerstand or sidestand does not move up and down smoothly, have a Yamaha dealer check or repair it.

## Recommended lubricant:

Lithium-soap-based grease (all-purpose grease)

## Lubricating the swingarm pivots

EAUM1650

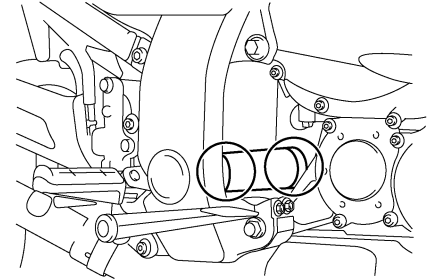

The swingarm pivots must be lubricated at the intervals specified in the periodic maintenance and lubrication chart.

## Recommended lubricant:

Lithium-soap-based grease

# PERIODIC MAINTENANCE AND MINOR REPAIR

## Lubricating the rear suspension

EAU23250

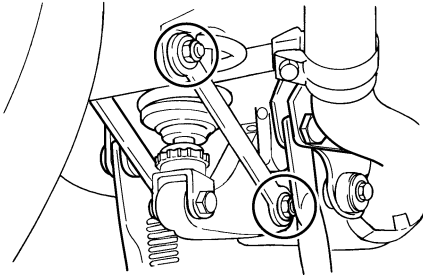

The pivoting points of the rear suspension must be lubricated at the intervals specified in the periodic maintenance and lubrication chart.

6

**Recommended lubricant:**  
Lithium-soap-based grease

## Checking the front fork

EAU23271

The condition and operation of the front fork must be checked as follows at the intervals specified in the periodic maintenance and lubrication chart.

### To check the condition

EWA10750



**Securely support the vehicle so that there is no danger of it falling over.**

Check the inner tubes for scratches, damage and excessive oil leakage.

### To check the operation

1. Place the vehicle on a level surface and hold it in an upright position.
2. While applying the front brake, push down hard on the handlebars several times to check if the front fork compresses and rebounds smoothly.

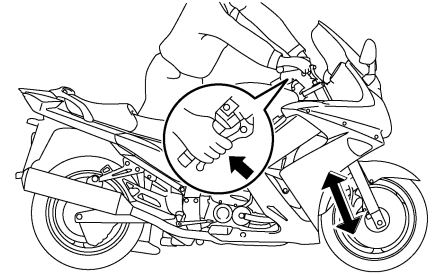

ECA10590

### CAUTION:

**If any damage is found or the front fork does not operate smoothly, have a Yamaha dealer check or repair it.**

## Checking the steering

EAU23280

Worn or loose steering bearings may cause danger. Therefore, the operation of the steering must be checked as follows at the intervals specified in the periodic maintenance and lubrication chart.

1. Place a stand under the engine to raise the front wheel off the ground.

EWA10750

### **WARNING**

**Securely support the vehicle so that there is no danger of it falling over.**

2. Hold the lower ends of the front fork legs and try to move them forward and backward. If any free play can be felt, have a Yamaha dealer check or repair the steering.

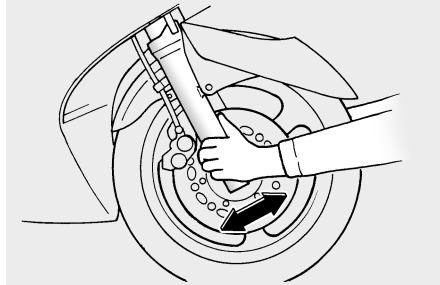

## Checking the wheel bearings

EAU23290

The front and rear wheel bearings must be checked at the intervals specified in the periodic maintenance and lubrication chart. If there is play in the wheel hub or if the wheel does not turn smoothly, have a Yamaha dealer check the wheel bearings.

# PERIODIC MAINTENANCE AND MINOR REPAIR

## Battery

EAU39520

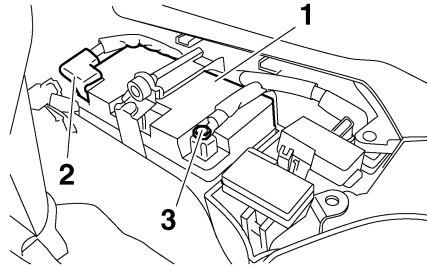

1. Battery
2. Positive battery terminal
3. Negative battery terminal

6

The battery is located under panel A. (See page 6-8.)

This vehicle is equipped with a sealed-type (MF) battery, which does not require any maintenance. There is no need to check the electrolyte or to add distilled water.

### To charge the battery

Have a Yamaha dealer charge the battery as soon as possible if it seems to have discharged. Keep in mind that the

battery tends to discharge more quickly if the vehicle is equipped with optional electrical accessories.

EWA10760

### WARNING

- **Electrolyte is poisonous and dangerous since it contains sulfuric acid, which causes severe burns. Avoid any contact with skin, eyes or clothing and always shield your eyes when working near batteries. In case of contact, administer the following FIRST AID.**
  - **EXTERNAL:** Flush with plenty of water.
  - **INTERNAL:** Drink large quantities of water or milk and immediately call a physician.
  - **EYES:** Flush with water for 15 minutes and seek prompt medical attention.
- **Batteries produce explosive hydrogen gas. Therefore, keep sparks, flames, cigarettes, etc., away from the battery and provide sufficient ventilation when charging it in an enclosed space.**

- **KEEP THIS AND ALL BATTERIES OUT OF THE REACH OF CHILDREN.**

### To store the battery

1. If the vehicle will not be used for more than one month, remove the battery, fully charge it, and then place it in a cool, dry place.
2. If the battery will be stored for more than two months, check it at least once a month and fully charge it if necessary.
3. Fully charge the battery before installation.
4. After installation, make sure that the battery leads are properly connected to the battery terminals.

ECA10630

### CAUTION:

- **Always keep the battery charged. Storing a discharged battery can cause permanent battery damage.**
- **To charge a sealed-type (MF) battery, a special (constant-voltage) battery charger is required. Using a conventional battery**

# PERIODIC MAINTENANCE AND MINOR REPAIR

charger will damage the battery. If you do not have access to a sealed-type (MF) battery charger, have a Yamaha dealer charge your battery.

## Replacing the fuses

EAU23656

The main fuse, the fuse boxes and the ABS motor fuse are located under panel A. (See page 6-8.)

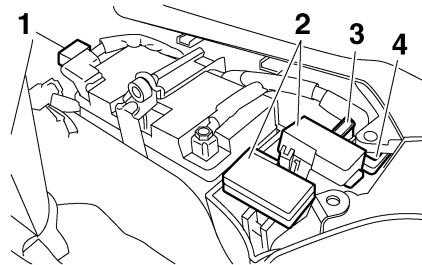

1. Main fuse
2. Fuse box
3. ABS motor fuse
4. ABS motor spare fuse

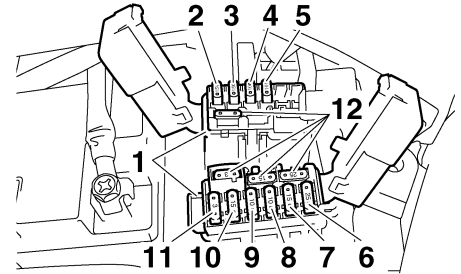

1. Fuse box
2. Right radiator fan fuse
3. Left radiator fan fuse
4. Hazard fuse
5. Backup fuse (for odometer and clock)
6. Headlight fuse
7. Signaling system fuse
8. ABS control unit fuse
9. Ignition fuse
10. Fuel injection system fuse
11. Auxiliary DC jack fuse
12. Spare fuse

If a fuse is blown, replace it as follows.

1. Turn the key to "OFF" and turn off the electrical circuit in question.
2. Remove the blown fuse, and then install a new fuse of the specified amperage.

# PERIODIC MAINTENANCE AND MINOR REPAIR

## Specified fuses:

Main fuse:

50.0 A

Headlight fuse:

25.0 A

Signaling system fuse:

15.0 A

Ignition fuse:

10.0 A

Radiator fan fuse:

15.0 A × 2

Backup fuse:

10.0 A

Hazard fuse:

10.0 A

Fuel injection system fuse:

15.0 A

ABS control unit fuse:

10.0 A

Auxiliary DC jack fuse:

3.0 A

ABS motor fuse:

30.0 A

ECA10640

## CAUTION:

**Do not use a fuse of a higher amperage rating than recommended to avoid causing extensive damage to the electrical system and possibly a fire.**

3. Turn the key to "ON" and turn on the electrical circuit in question to check if the device operates.
4. If the fuse immediately blows again, have a Yamaha dealer check the electrical system.

## Replacing a headlight bulb

EAU23900

This model is equipped with quartz bulb headlights. If a headlight bulb burns out, replace it as follows.

1. Remove panel D (if replacing the left headlight bulb) or panel C (if replacing the right headlight bulb). (See page 6-8.)
2. Disconnect the headlight coupler, and then remove the headlight bulb cover.

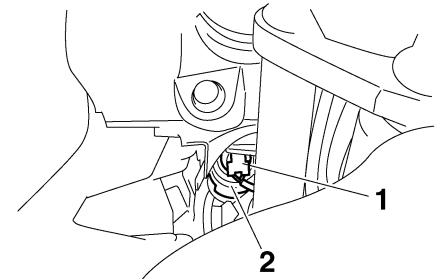

1. Headlight coupler

2. Headlight bulb cover

3. Unhook the headlight bulb holder, and then remove the defective bulb.

# PERIODIC MAINTENANCE AND MINOR REPAIR

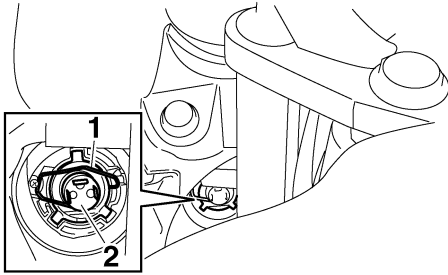

1. Headlight bulb holder
2. Headlight bulb

EWA10790

## **WARNING**

Headlight bulbs get very hot. Therefore, keep flammable products away from a lit headlight bulb, and do not touch the bulb until it has cooled down.

4. Place a new headlight bulb into position, and then secure it with the bulb holder.

ECA10650

## **CAUTION:**

Take care not to damage the following parts:

### ● Headlight bulb

Do not touch the glass part of the headlight bulb to keep it free from oil, otherwise the transparency of the glass, the luminosity of the bulb, and the bulb life will be adversely affected. Thoroughly clean off any dirt and fingerprints on the headlight bulb using a cloth moistened with alcohol or thinner.

### ● Headlight lens

Do not affix any type of tinted film or stickers to the headlight lens.

Do not use a headlight bulb of a wattage higher than specified.

5. Install the headlight bulb cover, and then connect the coupler.
6. Install the panel.
7. Have a Yamaha dealer adjust the headlight beam if necessary.

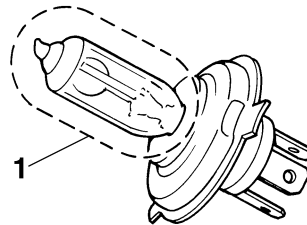

1. Do not touch the glass part of the bulb.

# PERIODIC MAINTENANCE AND MINOR REPAIR

## Front turn signal light

EAU39880

If a front turn signal light does not come on, have a Yamaha dealer check its electrical circuit or replace the bulb.

## Replacing a rear turn signal light bulb or a tail/brake light bulb

EAU27001

1. Remove the passenger seat. (See page 3-14.)
2. Remove the socket (together with the bulb) by turning it counter-clockwise.

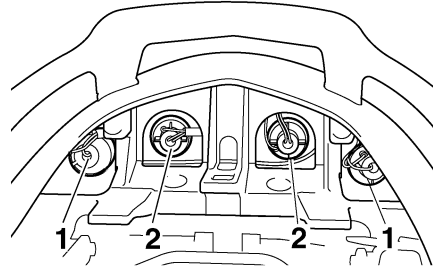

1. Turn signal light bulb socket
2. Tail/brake light bulb socket
3. Remove the defective bulb by pushing it in and turning it counter-clockwise.
4. Insert a new bulb into the socket, push it in, and then turn it clockwise until it stops.
5. Install the socket (together with the bulb) by turning it clockwise.

6. Install the passenger seat.



EAU24310

## Replacing the license plate light bulb

1. Remove the license plate light unit by removing the screws.

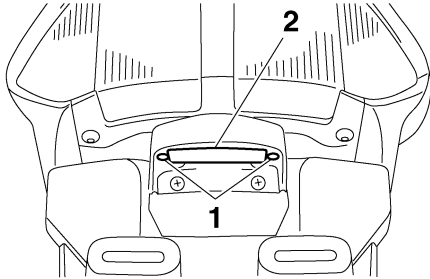

1. Screw
2. License plate light unit

2. Remove the socket (together with the bulb) by pulling it out.

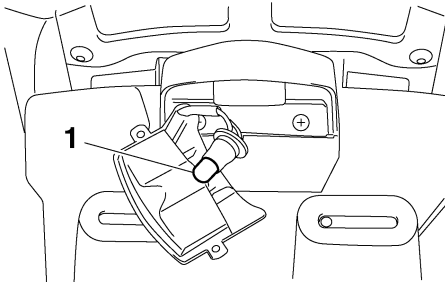

1. License plate light bulb

3. Remove the defective bulb by pulling it out.
4. Insert a new bulb into the socket.
5. Install the socket (together with the bulb) by pushing it in.
6. Install the license plate light unit by installing the screws.

## Troubleshooting

EAU25870

Although Yamaha motorcycles receive a thorough inspection before shipment from the factory, trouble may occur during operation. Any problem in the fuel, compression, or ignition systems, for example, can cause poor starting and loss of power.

The following troubleshooting charts represent quick and easy procedures for checking these vital systems yourself. However, should your motorcycle require any repair, take it to a Yamaha dealer, whose skilled technicians have the necessary tools, experience, and know-how to service the motorcycle properly.

Use only genuine Yamaha replacement parts. Imitation parts may look like Yamaha parts, but they are often inferior, have a shorter service life and can lead to expensive repair bills.

# PERIODIC MAINTENANCE AND MINOR REPAIR

EAU25911

## Troubleshooting charts

### Starting problems or poor engine performance

EWA10840



**WARNING**

Keep away open flames and do not smoke while checking or working on the fuel system.

#### 1. Fuel

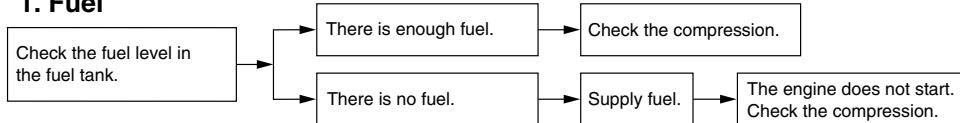

#### 2. Compression

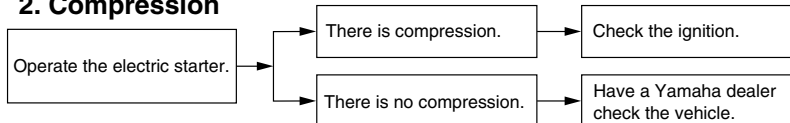

#### 3. Ignition

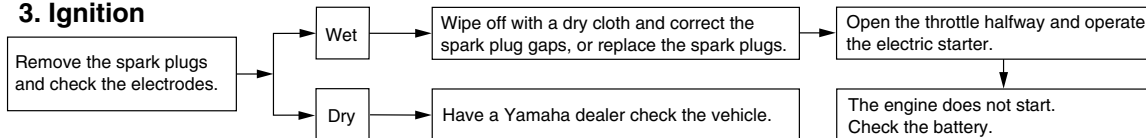

#### 4. Battery

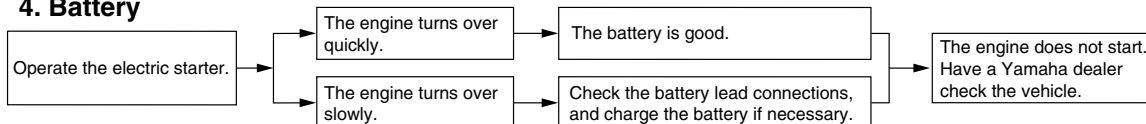

# PERIODIC MAINTENANCE AND MINOR REPAIR

## Engine overheating

EWA10400

### WARNING

- Do not remove the radiator cap when the engine and radiator are hot. Scalding hot fluid and steam may be blown out under pressure, which could cause serious injury. Be sure to wait until the engine has cooled.
- After removing the radiator cap retaining bolt, place a thick rag, like a towel, over the radiator cap, and then slowly rotate the cap counterclockwise to the detent to allow any residual pressure to escape. When the hissing sound has stopped, press down on the cap while turning it counterclockwise, and then remove the cap.

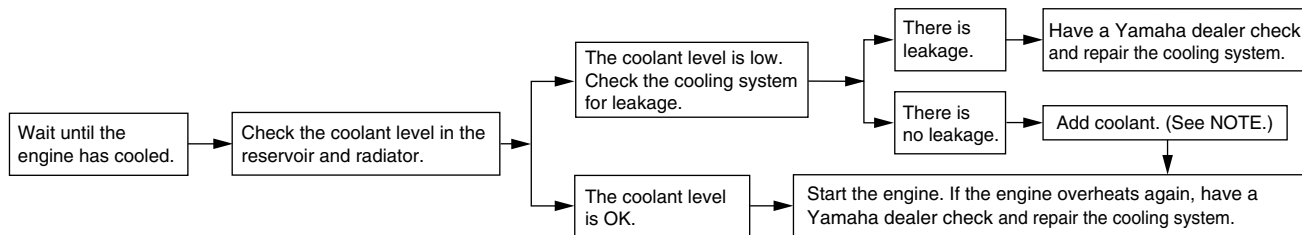

### NOTE:

If coolant is not available, tap water can be temporarily used instead, provided that it is changed to the recommended coolant as soon as possible.

# MOTORCYCLE CARE AND STORAGE

---

EAU26060

## Care

While the open design of a motorcycle reveals the attractiveness of the technology, it also makes it more vulnerable. Rust and corrosion can develop even if high-quality components are used. A rusty exhaust pipe may go unnoticed on a car, however, it detracts from the overall appearance of a motorcycle. Frequent and proper care does not only comply with the terms of the warranty, but it will also keep your motorcycle looking good, extend its life and optimize its performance.

## Before cleaning

1. Cover the muffler outlets with plastic bags after the engine has cooled down.
2. Make sure that all caps and covers as well as all electrical couplers and connectors, including the spark plug caps, are tightly installed.
3. Remove extremely stubborn dirt, like oil burnt onto the crankcase, with a degreasing agent and a brush, but never apply such prod-

ucts onto seals, gaskets and wheel axles. Always rinse the dirt and degreaser off with water.

## Cleaning

ECA10770

### CAUTION:

- **Avoid using strong acidic wheel cleaners, especially on spoked wheels. If such products are used on hard-to-remove dirt, do not leave the cleaner on the affected area any longer than instructed. Also, thoroughly rinse the area off with water, immediately dry it, and then apply a corrosion protection spray.**
- **Improper cleaning can damage windshields, cowlings, panels and other plastic parts. Use only a soft, clean cloth or sponge with mild detergent and water to clean plastic.**
- **Do not use any harsh chemical products on plastic parts. Be sure to avoid using cloths or sponges which have been in contact with strong or abrasive cleaning products, solvent or**

thinner, fuel (gasoline), rust removers or inhibitors, brake fluid, antifreeze or electrolyte.

- **Do not use high-pressure washers or steam-jet cleaners since they cause water seepage and deterioration in the following areas: seals (of wheel and swing-arm bearings, fork and brakes), electric components (couplers, connectors, instruments, switches and lights), breather hoses and vents.**
- **For motorcycles equipped with a windshield: Do not use strong cleaners or hard sponges as they will cause dulling or scratching. Some cleaning compounds for plastic may leave scratches on the windshield. Test the product on a small hidden part of the windshield to make sure that it does not leave any marks. If the windshield is scratched, use a quality plastic polishing compound after washing.**

# MOTORCYCLE CARE AND STORAGE

## After normal use

Remove dirt with warm water, a mild detergent, and a soft, clean sponge, and then rinse thoroughly with clean water. Use a toothbrush or bottlebrush for hard-to-reach areas. Stubborn dirt and insects will come off more easily if the area is covered with a wet cloth for a few minutes before cleaning.

## After riding in the rain, near the sea or on salt-sprayed roads

Since sea salt or salt sprayed on roads during winter are extremely corrosive in combination with water, carry out the following steps after each ride in the rain, near the sea or on salt-sprayed roads.

### **NOTE:**

Salt sprayed on roads in the winter may remain well into spring.

1. Clean the motorcycle with cold water and a mild detergent, after the engine has cooled down.

### **CAUTION:**

**Do not use warm water since it increases the corrosive action of the salt.**

2. After drying the motorcycle, apply a corrosion protection spray on all metal, including chrome- and nickel-plated, surfaces to prevent corrosion.

### **After cleaning**

1. Dry the motorcycle with a chamois or an absorbing cloth.
2. Use a chrome polish to shine chrome, aluminum and stainless-steel parts, including the exhaust system. (Even the thermally induced discoloring of stainless-steel exhaust systems can be removed through polishing.)
3. To prevent corrosion, it is recommended to apply a corrosion protection spray on all metal, including chrome- and nickel-plated, surfaces.
4. Use spray oil as a universal cleaner to remove any remaining dirt.

ECA10790

5. Touch up minor paint damage caused by stones, etc.
6. Wax all painted surfaces.
7. Let the motorcycle dry completely before storing or covering it.

### **WARNING**

- **Make sure that there is no oil or wax on the brakes or tires.**
- **If necessary, clean the brake discs and brake linings with a regular brake disc cleaner or acetone, and wash the tires with warm water and a mild detergent. Before riding at higher speeds, test the motorcycle's braking performance and cornering behavior.**

### **CAUTION:**

- **Apply spray oil and wax sparingly and make sure to wipe off any excess.**
- **Never apply oil or wax to any rubber and plastic parts, but treat them with a suitable care product.**

EWA11130

ECA10800

# MOTORCYCLE CARE AND STORAGE

---

- **Avoid using abrasive polishing compounds as they will wear away the paint.**
- 

**NOTE:** \_\_\_\_\_  
Consult a Yamaha dealer for advice on what products to use.

---

## Storage

EAU26241

### Short-term

Always store your motorcycle in a cool, dry place and, if necessary, protect it against dust with a porous cover.

ECA10810

### CAUTION:

- **Storing the motorcycle in a poorly ventilated room or covering it with a tarp, while it is still wet, will allow water and humidity to seep in and cause rust.**
  - **To prevent corrosion, avoid damp cellars, stables (because of the presence of ammonia) and areas where strong chemicals are stored.**
- 

### Long-term

Before storing your motorcycle for several months:

1. Follow all the instructions in the "Care" section of this chapter.
2. Fill up the fuel tank and add fuel stabilizer (if available) to prevent the fuel tank from rusting and the fuel from deteriorating.

3. Perform the following steps to protect the cylinders, piston rings, etc. from corrosion.
  - a. Remove the spark plug caps and spark plugs.
  - b. Pour a teaspoonful of engine oil into each spark plug bore.
  - c. Install the spark plug caps onto the spark plugs, and then place the spark plugs on the cylinder head so that the electrodes are grounded. (This will limit sparking during the next step.)
  - d. Turn the engine over several times with the starter. (This will coat the cylinder walls with oil.)
  - e. Remove the spark plug caps from the spark plugs, and then install the spark plugs and the spark plug caps.

EWA10950

### **WARNING**

**To prevent damage or injury from sparking, make sure to ground the spark plug electrodes while turning the engine over.**

---

4. Lubricate all control cables and the pivoting points of all levers and pedals as well as of the side-stand/centerstand.
5. Check and, if necessary, correct the tire air pressure, and then lift the motorcycle so that both of its wheels are off the ground. Alternatively, turn the wheels a little every month in order to prevent the tires from becoming degraded in one spot.
6. Cover the muffler outlets with plastic bags to prevent moisture from entering them.
7. Remove the battery and fully charge it. Store it in a cool, dry place and charge it once a month. Do not store the battery in an excessively cold or warm place [less than 0 °C (30 °F) or more than 30 °C (90 °F)]. For more information on storing the battery, see page 6-32.

**NOTE:** \_\_\_\_\_  
Make any necessary repairs before storing the motorcycle.

---

# SPECIFICATIONS

## Dimensions:

Overall length:  
2230 mm (87.8 in)  
Overall width:  
750 mm (29.5 in)  
Overall height:  
1450 mm (57.1 in)  
Seat height:  
800 mm (31.5 in)  
Wheelbase:  
1545 mm (60.8 in)  
Ground clearance:  
130 mm (5.12 in)  
Minimum turning radius:  
3100 mm (122.0 in)

## Weight:

With oil and fuel:  
291.0 kg (642 lb) (U49)  
292.0 kg (644 lb) (CAL)

## Engine:

Engine type:  
Liquid cooled 4-stroke, DOHC  
Cylinder arrangement:  
Forward-inclined parallel 4-cylinder  
Displacement:  
1298.0 cm<sup>3</sup> (79.20 cu.in)  
Bore × stroke:  
79.0 × 66.2 mm (3.11 × 2.61 in)  
Compression ratio:  
10.80 :1  
Starting system:  
Electric starter  
Lubrication system:  
Wet sump

## Engine oil:

Type:  
YAMALUBE 4 (20W40) or SAE20W40  
Recommended engine oil grade:  
API service SE, SF, SG type or higher  
Engine oil quantity:  
Without oil filter cartridge replacement:  
3.80 L (4.02 US qt) (3.34 Imp.qt)  
With oil filter cartridge replacement:  
4.00 L (4.23 US qt) (3.52 Imp.qt)

## Final gear oil:

Type:  
Shaft drive gear oil  
Quantity:  
0.20 L (0.21 US qt) (0.18 Imp.qt)

## Cooling system:

Coolant reservoir capacity (up to the maximum level mark):  
0.25 L (0.26 US qt) (0.22 Imp.qt)  
Radiator capacity (including all routes):  
2.60 L (2.75 US qt) (2.29 Imp.qt)

## Air filter:

Air filter element:  
Dry element

## Fuel:

Recommended fuel:  
Unleaded gasoline only  
Fuel tank capacity:  
25.0 L (6.61 US gal) (5.50 Imp.gal)  
Fuel reserve amount:  
5.5 L (1.45 US gal) (1.21 Imp.gal)

## Fuel injector:

Manufacturer:  
NIPPON INJECTOR

Model/quantity:  
INP-151/4

## Spark plug (s):

Manufacturer/model:  
NGK/CR8E  
Manufacturer/model:  
DENSO/U24ESR-N  
Spark plug gap:  
0.7–0.8 mm (0.028–0.031 in)

## Clutch:

Clutch type:  
Wet, multiple-disc

## Transmission:

Primary reduction system:  
Spur gear  
Primary reduction ratio:  
75/48 (1.563)  
Secondary reduction system:  
Shaft drive  
Secondary reduction ratio:  
35/37 × 21/27 × 33/9 (2.698)  
Transmission type:  
Constant mesh 5-speed  
Operation:  
Left foot operation  
Gear ratio:  
1st:  
43/17 (2.529)  
2nd:  
39/22 (1.773)  
3rd:  
31/23 (1.348)  
4th:  
28/26 (1.077)



5th:  
26/28 (0.929)

## Chassis:

Frame type:  
Diamond  
Caster angle:  
26.00 °  
Trail:  
109.0 mm (4.29 in)

## Front tire:

Type:  
Tubeless  
Size:  
120/70 ZR17M/C (58W)  
Manufacturer/model:  
METZELER/Roadtec Z6G  
Manufacturer/model:  
BRIDGESTONE/BT020F

## Rear tire:

Type:  
Tubeless  
Size:  
180/55 ZR17M/C (73W)  
Manufacturer/model:  
METZELER/Roadtec Z6C  
Manufacturer/model:  
BRIDGESTONE/BT020R

## Loading:

Maximum load:  
211 kg (465 lb) (CAL)  
212 kg (467 lb) (U49)  
(Total weight of rider, passenger, cargo and accessories)

## Tire air pressure (measured on cold tires):

Loading condition:  
0–90 kg (0–198 lb)  
Front:  
270 kPa (39 psi) (2.70 kgf/cm<sup>2</sup>)  
Rear:  
290 kPa (42 psi) (2.90 kgf/cm<sup>2</sup>)

Loading condition:  
90–211 kg (198–465 lb) (CAL)  
90–212 kg (198–467 lb) (U49)  
Front:  
270 kPa (39 psi) (2.70 kgf/cm<sup>2</sup>)  
Rear:  
290 kPa (42 psi) (2.90 kgf/cm<sup>2</sup>)

High-speed riding:  
Front:  
270 kPa (39 psi) (2.70 kgf/cm<sup>2</sup>)  
Rear:  
290 kPa (42 psi) (2.90 kgf/cm<sup>2</sup>)

## Front wheel:

Wheel type:  
Cast wheel  
Rim size:  
17M/C x MT3.50

## Rear wheel:

Wheel type:  
Cast wheel  
Rim size:  
17M/C x MT5.50

## Front brake:

Type:  
Dual disc brake

Operation:  
Right hand operation  
Recommended fluid:  
DOT 4

## Rear brake:

Type:  
Single disc brake  
Operation:  
Right foot operation  
Recommended fluid:  
DOT 4

## Front suspension:

Type:  
Telescopic fork  
Spring/shock absorber type:  
Coil spring/oil damper  
Wheel travel:  
135.0 mm (5.31 in)

## Rear suspension:

Type:  
Swingarm (link suspension)  
Spring/shock absorber type:  
Coil spring/gas-oil damper  
Wheel travel:  
125.0 mm (4.92 in)

## Electrical system:

Ignition system:  
Transistorized coil ignition (digital)  
Charging system:  
AC magneto

## Battery:

Model:  
GT14B-4

# SPECIFICATIONS

---

Voltage, capacity:  
12 V, 12.0 Ah

## Headlight:

Bulb type:  
Halogen bulb

## Bulb voltage, wattage × quantity:

Headlight:  
12 V, 60 W/55.0 W × 2  
Tail/brake light:  
12 V, 5.0 W/21.0 W × 2  
Front turn signal/position light:  
12 V, 21 W/5.0 W × 2  
Rear turn signal light:  
12 V, 21.0 W × 2  
License plate light:  
12 V, 5.0 W × 1  
Meter lighting:  
LED  
Neutral indicator light:  
LED  
High beam indicator light:  
LED  
Oil level warning light:  
LED  
Turn signal indicator light:  
LED  
Engine trouble warning light:  
LED  
ABS warning light:  
LED

## Fuses:

Main fuse:  
50.0 A

Headlight fuse:  
25.0 A  
Signaling system fuse:  
15.0 A  
Ignition fuse:  
10.0 A  
Radiator fan fuse:  
15.0 A × 2  
Hazard fuse:  
10.0 A  
Fuel injection system fuse:  
15.0 A  
ABS control unit fuse:  
10.0 A  
ABS motor fuse:  
30.0 A  
Auxiliary DC jack fuse:  
3.0 A  
Backup fuse:  
10.0 A

EAU26351

## Identification numbers

Record the key identification number, vehicle identification number and model label information in the spaces provided below for assistance when ordering spare parts from a Yamaha dealer or for reference in case the vehicle is stolen.

KEY IDENTIFICATION NUMBER:

VEHICLE IDENTIFICATION NUMBER:

MODEL LABEL INFORMATION:

## Key identification number

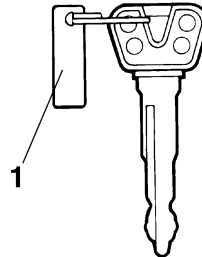

1. Key identification number

The key identification number is stamped into the key tag. Record this number in the space provided and use it for reference when ordering a new key.

EAU26381

## Vehicle identification number

EAU26400

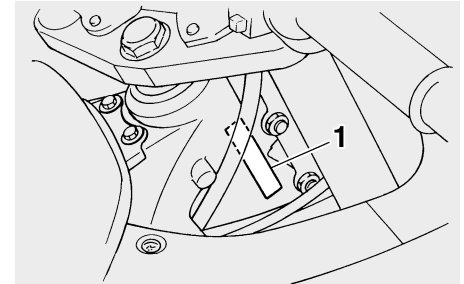

1. Vehicle identification number

The vehicle identification number is stamped into the steering head pipe. Record this number in the space provided.

**NOTE:** \_\_\_\_\_

The vehicle identification number is used to identify your motorcycle and may be used to register your motorcycle with the licensing authority in your area.

\_\_\_\_\_

# CONSUMER INFORMATION

---

EAU26520

## Model label

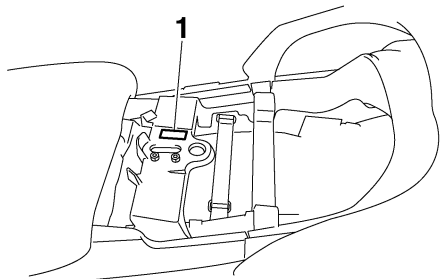

### 1. Model label

The model label is affixed to the frame under the passenger seat. (See page 3-14.) Record the information on this label in the space provided. This information will be needed when ordering spare parts from a Yamaha dealer.

## Reporting safety defects

If you believe that your vehicle has a defect which could cause a crash or could cause injury or death, you should immediately inform the National Highway Traffic Safety Administration (NHTSA) in addition to notifying Yamaha Motor Corporation, U.S.A. If NHTSA receives similar complaints, it may open an investigation, and if it finds that a safety defect exists in a group of vehicles, it may order a recall and remedy campaign. However, NHTSA cannot become involved in individual problems between you, your dealer, or Yamaha Motor Corporation, U.S.A.

To contact NHTSA, you may either call the Auto Safety Hotline toll-free at 1-800-424-9393 (or 366-0123 in Washington, D.C. area) or write to: NHTSA, U.S. Department of Transportation, Washington, D.C. 20590. You can also obtain other information about motor vehicle safety from the Hotline.

# CONSUMER INFORMATION

---

EAU26560

## Motorcycle noise regulation

### TAMPERING WITH NOISE CONTROL SYSTEM PROHIBITED:

Federal law prohibits the following acts or the causing thereof: (1) The removal or rendering inoperative by any person other than for purposes of maintenance, repair, or replacement of any device or element of design incorporated into any new vehicle for the purpose of noise control prior to its sale or delivery to the ultimate purchaser or while it is in use or (2) the use of the vehicle after such device or element of design has been removed or rendered inoperative by any person.

“AMONG THOSE ACTS PRESUMED TO CONSTITUTE TAMPERING ARE THE ACTS LISTED BELOW”.

These acts include tampering with the following systems; i.e., modification, removal, etc.

#### **Exhaust system**

- Muffler
- Exhaust pipe
- Silencer

#### **Intake system**

- Air cleaner case
- Air cleaner element
- Intake duct

## Maintenance record

Copies of work orders and/or receipts for parts purchased and installed on your vehicle will be required to document that maintenance has been completed in accordance with the emissions warranty. The chart below is printed only as a reminder that maintenance work is required. It is not acceptable proof of maintenance work.

Maintenance interval	Date of service	Mileage	Servicing dealer name and address	Remarks
600 mi (1000 km) or 1 month				
4000 mi (7000 km) or 6 months				
8000 mi (13000 km) or 12 months				
12000 mi (19000 km) or 18 months				
16000 mi (25000 km) or 24 months				
20000 mi (31000 km) or 30 months				
24000 mi (37000 km) or 36 months				
28000 mi (43000 km) or 42 months				
32000 mi (49000 km) or 48 months				

# CONSUMER INFORMATION

Maintenance interval	Date of service	Mileage	Servicing dealer name and address	Remarks
36000 mi (55000 km) or 54 months				
40000 mi (61000 km) or 60 months				



## YAMAHA MOTOR CORPORATION, U.S.A. STREET AND ENDURO MOTORCYCLE LIMITED WARRANTY

Yamaha Motor Corporation, U.S.A. hereby warrants each new model Yamaha motorcycle will be free from defects in material and workmanship for the period of time stated herein, subject to certain stated limitations.

**THE PERIOD OF WARRANTY** for Yamaha motorcycles originally equipped with headlight, stoplight, and turn signals shall be one (1) year from the date of purchase, with no mileage limitation.

**MODELS EXCLUDED FROM WARRANTY** include those used for non-Yamaha-authorized renting, leasing, or other commercial purposes, and TZ models.

**DURING THE PERIOD OF WARRANTY** any authorized Yamaha motorcycle dealer will, free of charge, repair or replace any part adjudged defective by Yamaha due to faulty workmanship or material from the factory. Parts used in warranty repairs will be warranted for the balance of the product's warranty period. All parts replaced under warranty become property of Yamaha Motor Corp. U.S.A.

**GENERAL EXCLUSIONS** from this warranty shall include any failures caused by:

- a. Competition or racing use.
- b. Installation of parts or accessories that are not qualitatively equivalent to genuine Yamaha parts.
- c. Abnormal strain, neglect, or abuse.
- d. Lack of proper maintenance.
- e. Accident or collision damage.
- f. Modification to original parts.

**SPECIFIC EXCLUSIONS** from this warranty shall include parts replaced due to normal wear or routine maintenance.

**THE CUSTOMER'S RESPONSIBILITY** under this warranty shall be to:

1. Operate and maintain the motorcycle as specified in the appropriate Owner's Manual, and
2. Give notice to an authorized Yamaha motorcycle dealer of any and all apparent defects within ten (10) days after discovery, and make the machine available at that time for inspection and repairs at such dealer's place of business.

**WARRANTY TRANSFER:** To transfer the warranty from the original purchaser to any subsequent purchaser, it is imperative that the machine be inspected and registered for warranty by an authorized Yamaha motorcycle dealer. In order for this warranty to remain in effect, this inspection and registration must take place within ten (10) days after transfer. An inspection and registration fee will be charged for this service.

### EMISSIONS CONTROL SYSTEM WARRANTY

Yamaha Motor Corporation, U.S.A. also warrants to the ultimate purchaser and each subsequent purchaser of each Yamaha motorcycle covered by this warranty with a displacement of 50cc or greater, that the vehicle is designed, built, and equipped so as to conform at the time of sale with all U.S. emissions standards applicable at the time of manufacture and that it is free from defects in materials and workmanship which would cause it not to meet these standards within the periods listed immediately below. Failure other than those resulting from defects in material or workmanship which arise solely as a result of owner abuse and / or lack of proper maintenance are not covered by this warranty.

### ENGINE

DISPLACEMENT	PERIOD
50cc to 169cc	12,000 km (7,465 miles) or five years, whichever occurs first
170cc to 279cc	18,000 km (11,185 miles) or five years, whichever occurs first
280cc or over	30,000 km (18,641 miles) or five years, whichever occurs first

**YAMAHA MOTOR CORPORATION, U.S.A. MAKES NO OTHER WARRANTY OF ANY KIND, EXPRESSED OR IMPLIED. ALL IMPLIED WARRANTIES OF MERCHANTABILITY AND FITNESS FOR A PARTICULAR PURPOSE WHICH EXCEED THE OBLIGATIONS AND TIME LIMITS STATED IN THIS WARRANTY ARE HEREBY DISCLAIMED BY YAMAHA MOTOR CORPORATION, U.S.A. AND EXCLUDED FROM THIS WARRANTY.**

**SOME STATES DO NOT ALLOW LIMITATIONS ON HOW LONG AN IMPLIED WARRANTY LASTS, SO THE ABOVE LIMITATION MAY NOT APPLY TO YOU. ALSO EXCLUDED FROM THIS WARRANTY ARE ANY INCIDENTAL OR CONSEQUENTIAL DAMAGES INCLUDING LOSS OF USE. SOME STATES DO NOT ALLOW THE EXCLUSION OR LIMITATION OF INCIDENTAL OR CONSEQUENTIAL DAMAGES, SO THE ABOVE EXCLUSION MAY NOT APPLY TO YOU.**

**THIS WARRANTY GIVES YOU SPECIFIC LEGAL RIGHTS, AND YOU MAY ALSO HAVE OTHER RIGHTS WHICH VARY FROM STATE TO STATE.**

YAMAHA MOTOR CORPORATION, U.S.A.  
P.O. Box 6555  
Cypress, California 90630

# CONSUMER INFORMATION

## WARRANTY QUESTIONS AND ANSWERS

- Q. What costs are my responsibility during the warranty period?
- A. The customer's responsibility includes all costs of normal maintenance services, non-warranty repairs, accident and collision damages, and oil, oil filters, air filters, spark plugs, and brake shoes.
- Q. What are some examples of "abnormal" strain, neglect, or abuse?
- A. These terms are general and overlap each other in areas. Specific examples include: Running the machine out of oil, sustained high-rpm, full-throttle, operating the machine with a broken or damaged part which causes another part to fail, damage or failure due to improper or careless transportation and or tie down. If you have any specific questions on operation or maintenance, please contact your dealer for advice.
- Q. Does the warranty cover incidental costs such as towing or transportation due to a failure?
- A. No. The warranty is limited to repair of the machine itself.
- Q. May I perform any or all of the recommended maintenance shown in the Owner's Manual instead of having the dealer do them?
- A. Yes, if you are a qualified mechanic and follow the procedures specified in the Owner's and Service Manual. We do recommend, however, that items requiring special tools or equipment be done by Yamaha Motorcycle dealer.
- Q. Will the warranty be void or cancelled if I do not operate or maintain my new motorcycle exactly as specified in the Owner's Manual?
- A. No. The warranty on a new motorcycle cannot be "voided" or "cancelled." **However, if a particular failure is caused by operation or maintenance other than as shown in the Owner's Manual, that failure may not be covered under warranty.**
- Q. What responsibility does my dealer have under this warranty?
- A. Each Yamaha Motorcycle dealer is expected to:
1. Completely set up every new machine before sale.
  2. Explain the operation, maintenance, and warranty requirements to your satisfaction at the time of sale, and upon your request at any later date.
  3. Each Yamaha Motorcycle dealer is held responsible for his setup, service and warranty repair work.
- Q. Is the warranty transferable to second owners?
- A. Yes. The remainder of the existing warranty can be transferred upon request. The unit has to be inspected and re-registered by an authorized Yamaha Motorcycle dealer for the policy to remain effective.

## CUSTOMER SERVICE

If your machine requires warranty service, you must take it to any authorized Yamaha Motorcycle dealer within the continental United States. Be sure to bring your warranty registration card or other valid proof of the original date of purchase. If a question or problem arises regarding warranty, first contact the owner of the dealership. Since all warranty matters are handled at the dealer level, this person is in the best position to help you. If you are still not satisfied and require additional assistance, please write:

YAMAHA MOTOR CORPORATION U.S.A.  
CUSTOMER RELATIONS DEPARTMENT  
P.O. Box 6555  
Cypress, California 90630

When contacting Yamaha Motor Corporation, U.S.A. don't forget to include any important information such as names, addresses, model, V.I.N. (frame number), dates, and receipts.

## CHANGE OF ADDRESS

The federal government requires each manufacturer of a motor vehicle to maintain a complete, up-to-date list of all first purchasers against the possibility of a safety-related defect and recall. This list is compiled from the purchase registrations sent to Yamaha Motor Corporation, U.S.A. by the selling dealer at the time of your purchase.

If you should move after you have purchased your new motorcycle, please advise us of your new address by sending a postcard listing your motorcycle model name, V.I.N. (frame number), dealer number (or dealer's name) as it is shown on your warranty card, your name and new mailing address. Mail to:

YAMAHA MOTOR CORPORATION, U.S.A.  
P.O. Box 6555  
Cypress, California 90630  
Attention: Warranty Department

This will ensure that Yamaha Motor Corporation, U.S.A. has an up-to-date registration record in accordance with federal law.

## YAMAHA EXTENDED SERVICE (Y.E.S.)

Keep your Yamaha protected even after your warranty expires with genuine Yamaha Extended Service (Y.E.S.).

- Y.E.S. is designed and administered by Yamaha Motor Corporation to provide maximum owner satisfaction. You get uninterrupted factory-backed coverage for extra peace of mind.
- Y.E.S. is flexible. You choose the plan that's right for you: 12 months, 24 months, 36 months or, on certain models, even 48 months beyond your warranty period.
- Y.E.S. is designed and administered by the same Yamaha people who handle your warranty – and it shows in the comprehensive coverage benefits. There are no mileage limitations. Coverage isn't limited to "moving parts" or the "drive train" like many other plans. And Y.E.S. covers manufacturing defects just like the warranty. See the sample contract at your Yamaha dealer to see how comforting uninterrupted factory-backed protection can be.
- You don't have to pay anything for covered repairs. There's no deductible to pay, and repairs aren't "pro-rated." You don't have any "out-of-pocket" expenses for covered repairs.
- In addition, Travel and Recreation Interruption Protection (TRIP) is included at no extra cost. TRIP gives you up to \$150 reimbursement per occurrence for any reasonable expenses you incur because your Yamaha needs covered service: replacement vehicle rental, emergency towing, phone calls, even food and lodging when you are away from home. This superb coverage goes into effect when you purchase Y.E.S., so it applies to any warranty repairs as well as covered repairs during your entire Y.E.S. plan period.
- Y.E.S. coverage is honored at any authorized Yamaha dealer nationwide.
- Y.E.S. coverage is transferable to a new owner if you sell or trade-in. That can make your Yamaha much more valuable!

This excellent Y.E.S. plan coverage is only available to Yamaha owners like you, and only while your Yamaha is still within the Yamaha Limited Warranty period. So visit your authorized Yamaha dealer to get all the facts. He can show you how easy it is to protect your investment with Yamaha Extended Service.

## CONSUMER INFORMATION

---

We urge you to act now. You'll get the excellent benefits of TRIP coverage right away, and you'll rest easy knowing you'll have strong factory-backed protection even after your Yamaha Limited Warranty expires.

A special note:

If visiting your dealer isn't convenient, contact Yamaha with your Primary ID number (your frame number). We'll be happy to help you get the Y.E.S. coverage you need.

Yamaha Service Marketing

P.O. Box 6555

Cypress, CA 90630

1-(866)-YES-EXTD (1-866-937-3983)



**YAMAHA**



**EXTENDED**



**SERVICE**

- A**
- ABS ..... 3-12
  - ABS warning light ..... 3-2
  - Accessories and replacement parts ..... 6-23
  - Accessory box ..... 3-18
  - Air filter element, cleaning ..... 6-18
  - Auxiliary DC jack ..... 3-27
- B**
- Battery ..... 6-32
  - Brake and clutch fluid levels, checking ..... 6-25
  - Brake and clutch fluids, changing ..... 6-27
  - Brake and clutch levers, checking and lubricating ..... 6-28
  - Brake and shift pedals, checking and lubricating ..... 6-28
  - Brake lever ..... 3-11
  - Brake pedal ..... 3-11
- C**
- Cables, checking and lubricating ..... 6-27
  - Canister (for California only) ..... 6-12
  - Care ..... 7-1
  - Catalytic converter ..... 3-14
  - Centerstand and sidestand, checking and lubricating ..... 6-29
  - Clutch lever ..... 3-10, 6-24
  - Coolant ..... 6-17
  - Cowlings, opening and closing ..... 3-20
- D**
- Dimmer switch ..... 3-9
- E**
- Engine break-in ..... 5-3
  - Engine oil and oil filter cartridge ..... 6-13
  - Engine stop switch ..... 3-9
  - Engine trouble warning light ..... 3-2
- F**
- Final gear oil ..... 6-15
  - Front and rear brake pads, checking ..... 6-25
  - Front fork, adjusting ..... 3-21
  - Front fork, checking ..... 6-30
  - Front turn signal light ..... 6-36
  - Fuel ..... 3-13
  - Fuel tank cap ..... 3-12
  - Fuses, replacing ..... 6-33
- H**
- Handlebar position, adjusting ..... 3-19
  - Handlebar switches ..... 3-8
  - Hazard switch ..... 3-9
  - Headlight beams, adjusting ..... 3-19
  - Headlight bulb, replacing ..... 6-34
  - High beam indicator light ..... 3-2
  - Horn switch ..... 3-9
- I**
- Identification numbers ..... 9-1
  - Ignition circuit cut-off system ..... 3-25
  - Indicator and warning lights ..... 3-2
- K**
- Key identification number ..... 9-1
- L**
- Labels, location of ..... 1-5
  - License plate light bulb, replacing ..... 6-37
- M**
- Main switch/steering lock ..... 3-1
  - Maintenance and lubrication, periodic ..... 6-4
  - Maintenance, emission control system ..... 6-3
  - Maintenance, periodic ..... 6-1
  - Maintenance record ..... 9-5
  - Model label ..... 9-2
- Multi-function display** ..... 3-4
- N**
- Neutral indicator light ..... 3-2
  - Noise regulation ..... 9-4
- O**
- Oil level warning light ..... 3-2
- P**
- Panels, removing and installing ..... 6-8
  - Parking ..... 5-4
  - Part locations ..... 2-1
  - Pre-operation check list ..... 4-2
- R**
- Rear brake light switch, adjusting ..... 6-24
  - Rear suspension, lubricating ..... 6-30
  - Rear view mirrors ..... 3-21
  - Rider seat height, adjusting ..... 3-16
- S**
- Safety defects, reporting ..... 9-3
  - Safety information ..... 1-1
  - Seats ..... 3-14
  - Shifting ..... 5-2
  - Shift pedal ..... 3-11
  - Shock absorber assembly, adjusting ..... 3-23
  - Sidestand ..... 3-24
  - Spark plugs, checking ..... 6-11
  - Specifications ..... 8-1
  - Speedometer ..... 3-3
  - Starting the engine ..... 5-1
  - Start switch ..... 3-9
  - Steering, checking ..... 6-31
  - Storage ..... 7-3
  - Storage compartments ..... 3-18
  - Swingarm pivots, lubricating ..... 6-29

# INDEX

---

## T

Tachometer .....	3-3
Throttle cable free play, checking .....	6-20
Throttle grip and cable, checking and lubricating .....	6-27
Tires .....	6-20
Tool kit .....	6-1
Troubleshooting .....	6-37
Troubleshooting charts .....	6-38
Turn signal indicator lights .....	3-2
Turn signal light or tail/brake light bulb, replacing .....	6-36
Turn signal switch .....	3-9

## V

Valve clearance .....	6-20
Vehicle identification number .....	9-1

## W

Warranty, extended.....	9-9
Warranty, limited .....	9-7
Wheel bearings, checking.....	6-31
Wheels .....	6-23
Windshield position adjusting switch.....	3-9

**PROTECT YOUR INVESTMENT**

**Use *Genuine YAMAHA* Parts And Accessories**

***See your Authorized YAMAHA Dealer for a Genuine YAMAHA Service Manual.***



YAMAHA MOTOR CO., LTD.

PRINTED ON RECYCLED PAPER

Download from [www.somanuals.com](http://www.somanuals.com). All Manuals Search And Download.

PRINTED IN JAPAN  
2006.01-1.7×1 CR  
(E)

## Free Manuals Download Website

<http://myh66.com>

<http://usermanuals.us>

<http://www.somanuals.com>

<http://www.4manuals.cc>

<http://www.manual-lib.com>

<http://www.404manual.com>

<http://www.luxmanual.com>

<http://aubethermostatmanual.com>

Golf course search by state

<http://golfingnear.com>

Email search by domain

<http://emailbydomain.com>

Auto manuals search

<http://auto.somanuals.com>

TV manuals search

<http://tv.somanuals.com>