



reface
CS

reface
DX

reface
GP

reface
YC

MOBILE MINI KEYBOARD

Owner's Manual

EN

SPECIAL MESSAGE SECTION

This product utilizes batteries or an external power supply (adapter). DO NOT connect this product to any power supply or adapter other than one described in the manual, on the name plate, or specifically recommended by Yamaha.

This product should be used only with the components supplied or; a cart, rack, or stand that is recommended by Yamaha. If a cart, etc., is used, please observe all safety markings and instructions that accompany the accessory product.

SPECIFICATIONS SUBJECT TO CHANGE:

The information contained in this manual is believed to be correct at the time of printing. However, Yamaha reserves the right to change or modify any of the specifications without notice or obligation to update existing units.

This product, either alone or in combination with an amplifier and headphones or speaker/s, may be capable of producing sound levels that could cause permanent hearing loss. DO NOT operate for long periods of time at a high volume level or at a level that is uncomfortable. If you experience any hearing loss or ringing in the ears, you should consult an audiologist. IMPORTANT: The louder the sound, the shorter the time period before damage occurs.

NOTICE:

Service charges incurred due to a lack of knowledge relating to how a function or effect works (when the unit is operating as designed) are not covered by the manufacturer's warranty, and are therefore the owners responsibility. Please study this manual carefully and consult your dealer before requesting service.

ENVIRONMENTAL ISSUES:

Yamaha strives to produce products that are both user safe and environmentally friendly. We sincerely believe that our products and the production methods used to produce them, meet these goals. In keeping with both the letter and the spirit of the law, we want you to be aware of the following:

Battery Notice:

This product MAY contain a small non-rechargeable battery which (if applicable) is soldered in place. The average life span of this type of battery is approximately five years. When replacement becomes necessary, contact a qualified service representative to perform the replacement.

This product may also use "household" type batteries. Some of these may be rechargeable. Make sure that the battery being charged is a rechargeable type and that the charger is intended for the battery being charged.

When installing batteries, never mix old batteries with new ones, and never mix different types of batteries. Batteries MUST be installed correctly. Mismatches or incorrect installation may result in overheating and battery case rupture.

Warning:

Do not attempt to disassemble, or incinerate any battery. Keep all batteries away from children. Dispose of used batteries promptly and as regulated by the laws in your area. Note: Check with any retailer of household type batteries in your area for battery disposal information.

Disposal Notice:

Should this product become damaged beyond repair, or for some reason its useful life is considered to be at an end, please observe all local, state, and federal regulations that relate to the disposal of products that contain lead, batteries, plastics, etc. If your dealer is unable to assist you, please contact Yamaha directly.

NAME PLATE LOCATION:

The name plate is located on the bottom of the product. The model number, serial number, power requirements, etc., are located on this plate. You should record the model number, serial number, and the date of purchase in the spaces provided below and retain this manual as a permanent record of your purchase.

Model

Serial No.

Purchase Date

PLEASE KEEP THIS MANUAL

92-BP (bottom)

For reface CS/DX/CP/YC

COMPLIANCE INFORMATION STATEMENT (DECLARATION OF CONFORMITY PROCEDURE)

Responsible Party : Yamaha Corporation of America
Address : 6600 Orangethorpe Ave., Buena Park, Calif. 90620
Telephone : 714-522-9011
Type of Equipment : Mobile Mini Keyboard
Model Name : reface CS/DX/CP/YC

This device complies with Part 15 of the FCC Rules.

Operation is subject to the following two conditions:

- 1) this device may not cause harmful interference, and
 - 2) this device must accept any interference received including interference that may cause undesired operation.
- See user manual instructions if interference to radio reception is suspected.

* This applies only to products distributed by YAMAHA CORPORATION OF AMERICA.

(FCC DoC)

For AC adaptor and reface CS/DX/CP/YC

FCC INFORMATION (U.S.A.)

1. IMPORTANT NOTICE: DO NOT MODIFY THIS UNIT!

This product, when installed as indicated in the instructions contained in this manual, meets FCC requirements. Modifications not expressly approved by Yamaha may void your authority, granted by the FCC, to use the product.

- 2. IMPORTANT:** When connecting this product to accessories and/or another product use only high quality shielded cables. Cable/s supplied with this product MUST be used. Follow all installation instructions. Failure to follow instructions could void your FCC authorization to use this product in the USA.

- 3. NOTE:** This product has been tested and found to comply with the requirements listed in FCC Regulations, Part 15 for Class "B" digital devices. Compliance with these requirements provides a reasonable level of assurance that your use of this product in a residential environment will not result in harmful interference with other electronic devices. This equipment generates/uses radio frequencies and, if not installed and used according to the instructions found in the users manual, may cause interference harmful to the operation of other electronic devices. Compliance with FCC regula-

tions does not guarantee that interference will not occur in all installations. If this product is found to be the source of interference, which can be determined by turning the unit "OFF" and "ON," please try to eliminate the problem by using one of the following measures:

Relocate either this product or the device that is being affected by the interference.

Utilize power outlets that are on different branch (circuit breaker or fuse) circuits or install AC line filter/s.

In the case of radio or TV interference, relocate/reorient the antenna. If the antenna lead-in is 300 ohm ribbon lead, change the lead-in to co-axial type cable.

If these corrective measures do not produce satisfactory results, please contact the local retailer authorized to distribute this type of product. If you can not locate the appropriate retailer, please contact Yamaha Corporation of America, Electronic Service Division, 6600 Orangethorpe Ave, Buena Park, CA90620

The above statements apply ONLY to those products distributed by Yamaha Corporation of America or its subsidiaries.

* This applies only to products distributed by YAMAHA CORPORATION OF AMERICA.

(class B)

For AC adaptor

This device complies with Part 15 of the FCC Rules. Operation is subject to the following two conditions: (1) this device may not cause harmful interference, and (2) this device must accept any interference received, including interference that may cause undesired operation.

CAN ICES-3 (B)/NMB-3(B)

- This applies only to products distributed by Yamaha Canada Music Ltd.
- Ceci ne s'applique qu'aux produits distribués par Yamaha Canada Musique Ltée.
(can_b_01)

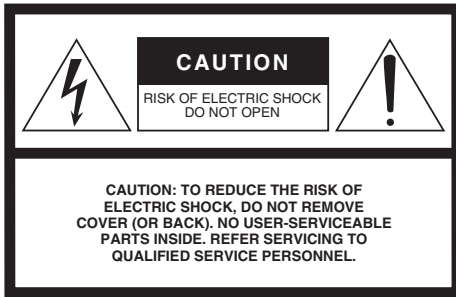

Explanation of Graphical Symbols



The lightning flash with arrowhead symbol within an equilateral triangle is intended to alert the user to the presence of uninsulated “dangerous voltage” within the product’s enclosure that may be of sufficient magnitude to constitute a risk of electric shock to persons.



The exclamation point within an equilateral triangle is intended to alert the user to the presence of important operating and maintenance (servicing) instructions in the literature accompanying the product.

IMPORTANT SAFETY INSTRUCTIONS

- 1 Read these instructions.
- 2 Keep these instructions.
- 3 Heed all warnings.
- 4 Follow all instructions.
- 5 Do not use this apparatus near water.
- 6 Clean only with dry cloth.
- 7 Do not block any ventilation openings. Install in accordance with the manufacturer’s instructions.
- 8 Do not install near any heat sources such as radiators, heat registers, stoves, or other apparatus (including amplifiers) that produce heat.
- 9 Do not defeat the safety purpose of the polarized or grounding-type plug. A polarized plug has two blades with one wider than the other. A grounding type plug has two blades and a third grounding prong. The wide blade or the third prong are provided for your safety. If the provided plug does not fit into your outlet, consult an electrician for replacement of the obsolete outlet.
- 10 Protect the power cord from being walked on or pinched particularly at plugs, convenience receptacles, and the point where they exit from the apparatus.
- 11 Only use attachments/accessories specified by the manufacturer.
- 12 Use only with the cart, stand, tripod, bracket, or table specified by the manufacturer, or sold with the apparatus. When a cart is used, use caution when moving the cart/apparatus combination to avoid injury from tip-over.
- 13 Unplug this apparatus during lightning storms or when unused for long periods of time.
- 14 Refer all servicing to qualified service personnel. Servicing is required when the apparatus has been damaged in any way, such as power-supply cord or plug is damaged, liquid has been spilled or objects have fallen into the apparatus, the apparatus has been exposed to rain or moisture, does not operate normally, or has been dropped.



WARNING

TO REDUCE THE RISK OF FIRE OR ELECTRIC SHOCK, DO NOT EXPOSE THIS APPARATUS TO RAIN OR MOISTURE.

(UL60065_03)

PRECAUTIONS

PLEASE READ CAREFULLY BEFORE PROCEEDING

Please keep this manual in a safe and handy place for future reference.

For AC adaptor



WARNING

- This AC adaptor is designed for use with only Yamaha electronic instruments. Do not use for any other purpose.
- Indoor use only. Do not use in any wet environments.



CAUTION

- When setting up, make sure that the AC outlet is easily accessible. If some trouble or malfunction occurs, immediately turn off the power switch of the instrument and disconnect the AC adaptor from the outlet. When the AC adaptor is connected to the AC outlet, keep in mind that electricity is flowing at the minimum level, even if the power switch is turned off. When you are not using the instrument for a long time, make sure to unplug the power cord from the wall AC outlet.

For reface CS/DX/CP/YC



WARNING

Always follow the basic precautions listed below to avoid the possibility of serious injury or even death from electrical shock, short-circuiting, damages, fire or other hazards. These precautions include, but are not limited to, the following:

Power supply/AC adaptor

- Do not place the power cord near heat sources such as heaters or radiators. Also, do not excessively bend or otherwise damage the cord, or place heavy objects on it.
- Only use the voltage specified as correct for the instrument. The required voltage is printed on the name plate of the instrument.
- Use the specified adaptor (page 48) only. Using the wrong adaptor can result in damage to the instrument or overheating.
- Check the electric plug periodically and remove any dirt or dust which may have accumulated on it.

Do not open

- This instrument contains no user-serviceable parts. Do not open the instrument or attempt to disassemble or modify the internal components in any way. If it should appear to be malfunctioning, discontinue use immediately and have it inspected by qualified Yamaha service personnel.

Water warning

- Do not expose the instrument to rain, use it near water or in damp or wet conditions, or place on it any containers (such as vases, bottles or glasses) containing liquids which might spill into any openings. If any liquid such as water seeps into the instrument, turn off the power immediately and unplug the power cord from the AC outlet. Then have the instrument inspected by qualified Yamaha service personnel.
- Never insert or remove an electric plug with wet hands.

Fire warning

- Do not put burning items, such as candles, on the unit. A burning item may fall over and cause a fire.

Battery

- Follow the precautions below. Failure to do so might result in explosion, fire, overheating or battery fluid leakage.
 - Do not tamper with or disassemble batteries.
 - Do not dispose of batteries in fire.
 - Do not attempt to recharge batteries that are not designed to be charged.
 - Keep the batteries separate from metallic objects such as necklaces, hairpins, coins, and keys.
 - Use the specified battery type (page 48) only.
 - Use new batteries, all of which are the same type, same model, and made by the same manufacturer.
 - Always make sure all batteries are inserted in conformity with the +/- polarity markings.
 - When the batteries run out, or if the instrument is not to be used for a long time, remove the batteries from the instrument.
 - When using Ni-MH batteries, follow the instructions that came with the batteries. Use only the specified charger device when charging.

- Keep batteries away from small children who might accidentally swallow them.
- If the batteries do leak, avoid contact with the leaked fluid. If the battery fluid should come in contact with your eyes, mouth, or skin, wash immediately with water and consult a doctor. Battery fluid is corrosive and may possibly cause loss of sight or chemical burns.

If you notice any abnormality

- When one of the following problems occur, immediately turn off the power switch and disconnect the electric plug from the outlet. (If you are using batteries, remove all batteries from the instrument.) Then have the device inspected by Yamaha service personnel.
 - The power cord or plug becomes frayed or damaged.
 - It emits unusual smells or smoke.
 - Some object has been dropped into the instrument.
 - There is a sudden loss of sound during use of the instrument.

CAUTION

Always follow the basic precautions listed below to avoid the possibility of physical injury to you or others, or damage to the instrument or other property. These precautions include, but are not limited to, the following:

Power supply/AC adaptor

- Do not connect the instrument to an electrical outlet using a multiple-connector. Doing so can result in lower sound quality, or possibly cause overheating in the outlet.
- When removing the electric plug from the instrument or an outlet, always hold the plug itself and not the cord. Pulling by the cord can damage it.
- Remove the electric plug from the outlet when the instrument is not to be used for extended periods of time, or during electrical storms.

Location

- Do not place the instrument in an unstable position where it might accidentally fall over.
- Before moving the instrument, remove all connected cables, to prevent damage to the cables or injury to anyone who might trip over them.
- When setting up the product, make sure that the AC outlet you are using is easily accessible. If some trouble or malfunction occurs, immediately turn off the power switch and disconnect the plug from the outlet. Even when the power switch is turned off, electricity is still flowing to the product at the minimum level. When you are not using the product for a long time, make sure to unplug the power cord from the wall AC outlet.

Connections

- Before connecting the instrument to other electronic components, turn off the power for all components. Before turning the power on or off for all components, set all volume levels to minimum.
- Be sure to set the volumes of all components at their minimum levels and gradually raise the volume controls while playing the instrument to set the desired listening level.

Handling caution

- Do not insert a finger or hand in any gaps on the instrument.
- Never insert or drop paper, metallic, or other objects into the gaps on the panel. This could cause physical injury to you or others, damage to the instrument or other property, or operational failure.
- Do not rest your weight on, or place heavy objects on the instrument, and do not use excessive force on the buttons, switches or connectors.
- Do not use the instrument/device or headphones for a long period of time at a high or uncomfortable volume level, since this can cause permanent hearing loss. If you experience any hearing loss or ringing in the ears, consult a physician.

Yamaha cannot be held responsible for damage caused by improper use or modifications to the instrument, or data that is lost or destroyed.

Always turn the power off when the instrument is not in use.

Even when the [⏻] (Standby/On) switch is in standby status (power lamp is off/ display is off), electricity is still flowing to the instrument at the minimum level.

When you are not using the instrument for a long time, make sure you unplug the power cord from the wall AC outlet.

Make sure to discard used batteries according to local regulations.

NOTICE

To avoid the possibility of malfunction/ damage to the product, damage to data, or damage to other property, follow the notices below.

■ Handling

- Do not use the instrument in the vicinity of a TV, radio, stereo equipment, mobile phone, or other electric devices. Otherwise, the instrument, TV, or radio may generate noise. When you use the instrument along with an application on your iPad or iPhone, we recommend that you set "Airplane Mode" to "ON" on that device in order to avoid noise caused by communication.
- Do not expose the instrument to excessive dust or vibrations, or extreme cold or heat (such as in direct sunlight, near a heater, or in a car during the day) to prevent the possibility of panel disfiguration, damage to the internal components or unstable operation.
- Do not place vinyl, plastic or rubber objects on the instrument, since this might discolor the panel or keyboard.

■ Maintenance

- When cleaning the instrument, use a soft and dry cloth. Do not use paint thinners, solvents, alcohol, cleaning fluids, or chemical-impregnated wiping cloths.

■ Saving data

- Keyboard settings (page 41) are stored automatically. It should be noted, however, that stored data may be lost in the event of malfunction, incorrect operation, and the like.
- Loop phrases recorded on the reface CS and reface DX cannot be stored.
- reface DX
 - Voice settings:
If voice setting data is not stored, it will be lost when the instrument is turned off, either manually or by the Auto Power-Off function (page 8).
 - MIDI and system settings:
MIDI and system settings will be lost if the instrument is turned off, either manually or by the Auto Power-Off function, without first changing the screen. It should also be noted that stored data may be lost in the event of malfunction, incorrect operation, and the like.

Information

■ About copyrights

- Copying of the commercially available musical data including but not limited to MIDI data and/ or audio data is strictly prohibited except for your personal use.
- This product incorporates and bundles contents in which Yamaha owns copyrights or with respect to which Yamaha has license to use others' copyrights. Due to copyright laws and other relevant laws, you are NOT allowed to distribute media in which these contents are saved or recorded and remain virtually the same or very similar to those in the product.
 - * The contents described above include a computer program, Accompaniment Style data, MIDI data, WAVE data, voice recording data, a score, score data, etc.
 - * You are allowed to distribute medium in which your performance or music production using these contents is recorded, and the permission of Yamaha Corporation is not required in such cases.

■ About this manual

- The illustrations as shown in this manual are for instructional purposes only, and may appear somewhat different from those on your instrument.
- Apple, iTunes, Mac, Macintosh, iPhone, and iPad are trademarks of Apple Inc., registered in the U.S. and other countries.
- The company names and product names in this manual are the trademarks or registered trademarks of their respective companies.
- The names of buttons, terminals, and the like from the instrument's front and rear panels are enclosed in [] (square brackets).
- Some sections of this manual refer to the reface CS, reface DX, reface CP, and reface YC as "CS," "DX," "CP," and "YC," respectively.

The model number, serial number, power requirements, etc., may be found on or near the name plate, which is at the bottom of the unit. You should note this serial number in the space provided below and retain this manual as a permanent record of your purchase to aid identification in the event of theft.

Model No.

Serial No.

(bottom_en_01)

Welcome

Thank you for purchasing a Yamaha reface synthesizer. This manual covers all four reface models—namely, the reface CS, reface DX, reface CP, and reface YC.

To get the most out of your new instrument, please confirm its model and then read this manual carefully. In addition, please keep this manual in a safe place so that you can refer back to it whenever needed.

Package contents

- Owner's Manual
- AC adaptor (May not be included depending on your area. Check with your Yamaha dealer.)
- MIDI breakout cable (mini-DIN to MIDI IN/OUT)

■ Digital manuals (PDF)

In addition to this Owner's Manual, the following manuals are available in digital format for this instrument.

- Reference Manual
- MIDI Reference
- iPhone/iPad Connection Manual

The digital-format manuals listed above can be obtained from the Yamaha Downloads web page. To do so, go to the web page using the following URL, enter "reface" or "iPhone/iPad" into the "Model Name" field, and then click "Search."

Yamaha Downloads: <http://download.yamaha.com/>

You will need Adobe Reader® installed on your computer in order to view pdf files. The newest version can be downloaded free of charge from the Adobe web site.

Main Features

- The specially developed tone generator of a full-fledged musical instrument and an HQ mini keys packed into a compact body.
- Built-in speakers and support for batteries so that you can easily make music anywhere, anytime.

reface CS

- Genuine synthesizer sounds produced by analog physical modeling (the AN tone generator)
- User interface featuring sliders for direct, intuitive control
- Four powerful, versatile effects built-in
- Phrase Looper for new forms of musical expression

reface CP

- Six classic keyboard sounds
- Carefully selected vintage effects can be combined with the keyboard sounds for even greater sonic diversity
- Distinct retro feel in both design and control

reface DX

- FM tone generator featuring a new feedback process
- Carefully designed FM section makes FM synthesis easy, even for the beginner
- Two slots each holding one of seven powerful, versatile effects
- Phrase Looper for new forms of musical expression

reface YC

- Five vintage organ sounds produced by an Organ Flutes tone generator
- Organ-like additive synthesis made possible by FOOTAGE sliders
- Intuitive control of the rotary speaker effect by using the ROTARY SPEED lever

Contents

<u>reface CS</u>	Functions of Front Panel Components 10 Using the Phrase Looper 14	CS
<u>reface DX</u>	Functions of Front Panel Components 16 Using the Phrase Looper 24	DX
<u>reface CP</u>	Functions of Front Panel Components 26 Voice Setting Examples 30	CP
<u>reface YC</u>	Functions of Front Panel Components 32 Voice Setting Examples 35	YC

PRECAUTIONS S-4
Welcome 2
Package contents 2
Main Features 2
Functions of Rear Panel Components 4
Turning On and Off 6
Using with the AC Adaptor 6
Using with Batteries 7
Turning On 8
Turning Off 8
Auto Power-Off 8

Connecting to Other Devices..... 36
Connecting to a MIDI Device 36
Connecting a Computer 37
Precautions when
Using the [USB] Terminal 39
Yamaha USB-MIDI Driver 39
Connecting an iPhone or iPad 39
Restoring the Factory Default Settings (Factory Reset)..... 40
Using the Factory Reset Function . 40
Appendix..... 41
Keyboard Settings 41
reface DX Messages 45
Troubleshooting 46
Specifications 48
Index 49

Functions of Rear Panel Components

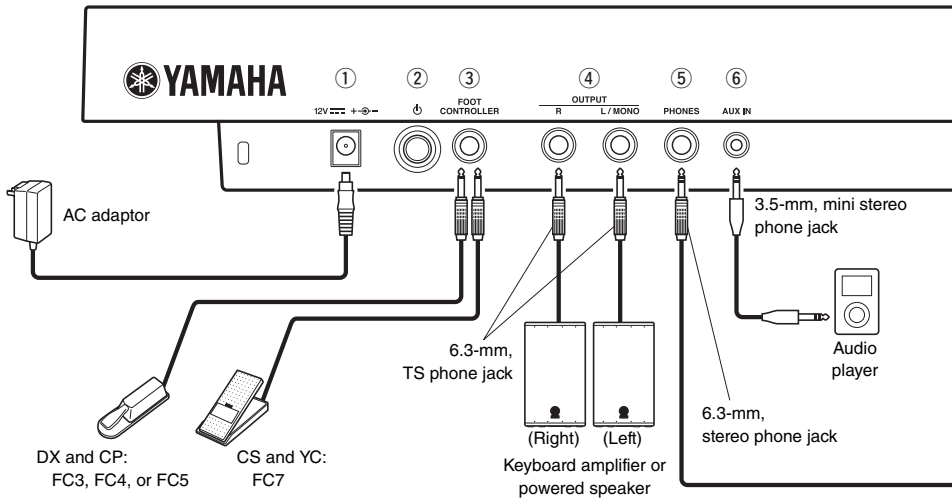

① DC IN jack (page 6)

For connecting the included AC adaptor.

② [Standby/On] switch (page 8)

For setting the instrument to standby () or turning it on ().

③ [FOOT CONTROLLER] or [SUSTAIN] jack

● reface CS and reface YC:

For connection of a separately sold foot controller (FC7) to adjust the volume.

● reface DX:

For connection of a separately sold foot switch (FC4 or FC5) to add sustain. Notes played while the foot switch is operated will sustain for longer than normal after you release the corresponding keys.

When a separately sold FC3 foot pedal is connected, MIDI messages for the half-damper position can be transmitted to any other connected MIDI device or computer. To do so, change “SUSTAIN” on the instrument’s System Settings screen to “FC3.” Please note that this instrument’s sounds are not affected by the half-damper effect.

● reface CP:

When a separately sold foot pedal (FC3) is connected, a sustain effect corresponding to the half-damper position can be applied. Notes played while the foot switch is operated will sustain for longer than normal after you release the corresponding keys. The degree to which the foot switch is applied will control the length of sustain.

Furthermore, when a separately sold foot switch (FC4 or FC5) is connected, a sustain effect unrelated to the half-damper position can be applied. In such a case, turn on the instrument by pressing the power button while holding down the G2 key on the keyboard. Multiple lamps on the front panel will flash, and the instrument’s pedal setting will change to “FC4/5.” See page 41 for details.

- In this manual, the term “FC3” refers to the FC3 and all other equivalent products, such as the FC3A.
- In this manual, the term “FC4” refers to the FC4 and all other equivalent products, such as the FC4A.

The illustration shows a reface CS but applies to all models.

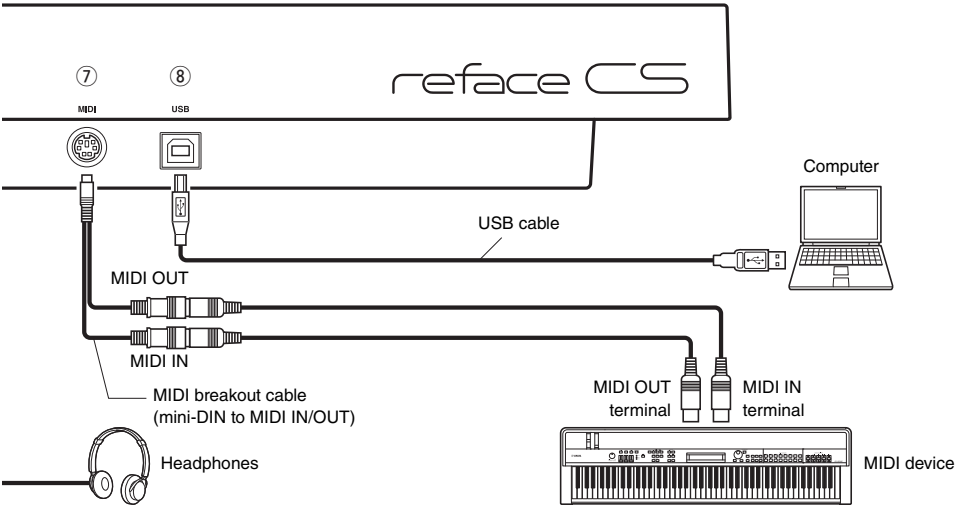

④ OUTPUT [R]/[L/MONO] jacks

For connecting keyboard amplifiers or powered speakers. The output from these standard stereo phone jacks is identical to that from the instrument's built-in speakers. If mono output is required, only the [L/MONO] jack should be connected.

⑤ [PHONES] jack

For connecting a pair of stereo headphones with a standard stereo phone plug (6.3-mm). If you wish to connect earphones or headphones having a mini stereo phone plug (3.5-mm) to this instrument, you will need to use a 3.5 mm to 6.3 mm adapter.

The instrument's built-in speakers automatically stop producing sound when headphones are connected to this jack. However, the OUTPUT jacks will continue to output the same sound as the [PHONES] jack.

⚠ CAUTION

To prevent hearing loss, avoid using headphones at high volumes for extended periods of time.

⑥ [AUX IN] jack

For connecting other audio equipment. The sound output from connected audio equipment can be mixed with that of this instrument.

NOTE

Adjust the volume of the connected audio equipment to balance the volumes of the two devices.

⑦ [MIDI] terminal (page 36)

For connecting other MIDI devices via the included MIDI breakout cable and standard MIDI cables (sold separately). MIDI messages can be both transmitted and received via this terminal.

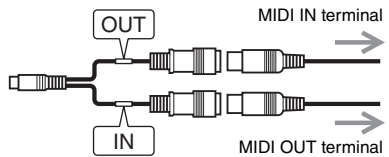

⑧ [USB] terminal (page 39)

For connecting a computer or a smart device such as an iPhone or iPad by using a USB 1.1 or 2.0 cable. MIDI messages can be both transmitted and received via this terminal. Refer to "Precautions when Using the [USB] Terminal" (page 39) for details.

NOTE

For details on how to connect an iPhone or iPad, refer to the "iPhone/iPad Connection Manual," which is available from the Yamaha web site.

Turning On and Off

This instrument can be powered by either an AC adaptor or batteries.

Using with the AC Adaptor

- ① Ensure that the [⏻] (Standby/On) switch is set to the standby condition (■).
- ② Insert the AC adaptor's DC plug into the instrument's DC IN jack.
- ③ Plug the AC adaptor into a domestic-use, AC wall socket.

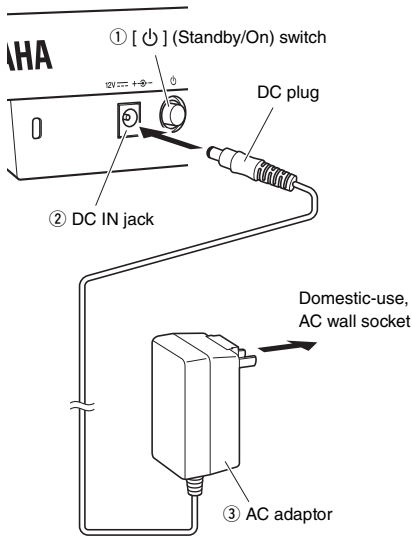

NOTE

- When disconnecting the AC adaptor, turn off the instrument and then carry out this procedure in reverse order.
- If the AC adaptor is connected, it will be used to power the instrument regardless of whether or not it contains batteries.
- Do not insert or remove the DC plug with the [⏻] (Standby/On) switch set to the On position (⬤). Failure to observe this precaution can lead to malfunction.

⚠ WARNING

- Be sure to use only the correct AC adaptor (page 48). The use of other adaptors may damage the instrument, cause it to overheat, or create a fire hazard. In such a case, the product warranty will immediately become void, even if the warranty period has not yet expired.
- Ensure that the included AC adaptor is plugged into a wall socket at the correct voltage.
- If your AC adaptor has a detachable plug, ensure that it is always used and stored with the plug attached. Inserting only the plug section into a wall socket can lead to electric shock or create a fire hazard.
- If the plug detaches from your AC adaptor, slide it back in until it clicks into place, taking care to avoid touching any internal metal parts. Please also ensure that no foreign objects enter the AC adaptor. Failure to observe this precaution can lead to electric shock, short circuits, or malfunction.

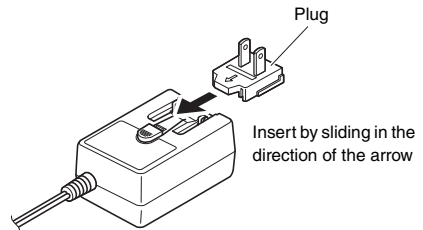

⚠ CAUTION

If you notice anything unusual when using this instrument in close proximity to a wall socket, immediately turn it off and remove the plug from the wall socket.

Using with Batteries

Type AA alkaline, zinc-carbon, or rechargeable nickel–metal hydride batteries can be used to power this instrument. However, certain modes of use can consume large amounts of power, and therefore, we recommend that you use either alkaline or rechargeable batteries.

- ① Ensure that the instrument is turned off.
- ② Place the instrument upside down on a soft cloth or the like, and then remove the battery cover.

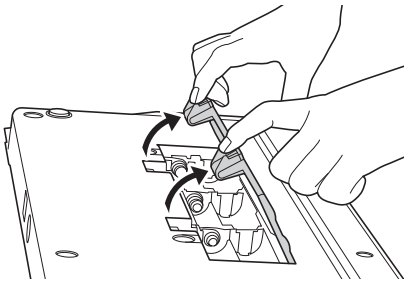

- ③ Insert six batteries. When doing so, be sure to observe the polarity markings in the following illustration.

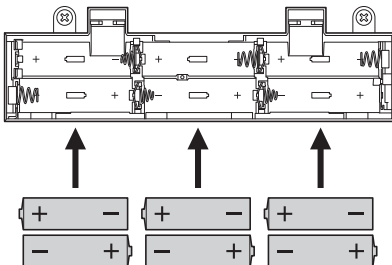

- ④ Close the battery cover.

NOTICE

- If you connect or disconnect the AC power while this instrument is turned on and powered by batteries, it may turn off. Please note that any data being recorded or not yet stored will be lost in such a case.
- We recommend that you replace worn batteries as soon as possible. Certain modes of operation, such as when Speaker Output is turned on, may cause the batteries to quickly become worn, and as a result, the instrument may be unable to function properly. In such a case, all of the batteries should be either replaced (if non-rechargeable) or recharged (if rechargeable). Furthermore, if you intend to use the instrument for an extended period of time, we recommend that the AC adaptor be used to power it.
- If you are using rechargeable batteries and lamps flash or a message is displayed to indicate that they have become worn, immediately recharge the batteries. Continued use of rechargeable batteries in this condition has an adverse effect on their lifespan.

NOTE

- Be sure to use a dedicated charger with rechargeable batteries. This instrument does not recharge batteries.
- If the AC adaptor is plugged into this instrument while it contains batteries, it will draw power from the adaptor.

The instrument behaves as follows when its batteries become worn.

● reface CS

The OSC lamp will flash.

● reface DX

The message “Battery Low!” will be displayed on-screen.

● reface CP

The TYPE lamp will flash.

● reface YC

The WAVE lamp will flash.

Turning On

- ① Move the [VOLUME] or [VOL] slider all the way down to minimize the output volume. If speakers or any other equipment such as a keyboard is connected, also turn the volume on those devices all the way down.
- ② Press the [⏻] (Standby/On) switch, which is located on the instrument's rear panel, to set it to the On position (▶).

- **reface CS, reface CP, and reface YC**

Multiple lamps on the front panel will light up.

- **reface DX**

The display will turn on.

- ③ Turn on any connected speakers or other equipment such as a keyboard.

Slowly raise the volume while playing the keyboard to confirm how loud the instrument is.

Turning Off

- ① Turn the volume of this instrument and any other connected equipment all the way down.
- ② Turn off the other equipment.
- ③ Press the [⏻] (Standby/On) switch, which is located on the instrument's rear panel, to set it to the Standby position (◻).

⚠ CAUTION

This instrument remains charged and draws a small amount of power even when turned off. Be sure to unplug the adaptor from the AC wall socket during electrical storms or if the instrument is not to be used for an extended period of time. In addition, batteries should be removed from the instrument in such a case.

NOTICE

- **reface CS:**
Loop phrases will be lost when the instrument is turned off.
- **reface DX:**
Loop phrases and any parameter settings not yet stored will be lost when the instrument is turned off.

Auto Power-Off

This instrument features an Auto Power-Off function that will help to save energy should you forget to turn it off yourself. This function automatically turns off the instrument after 30 minutes of inactivity. The Auto Power-Off setting is retained when the instrument is turned off. If this instrument is connected to other equipment such as amplifiers, speakers, or a computer, but you do not intend to use it for some time, we recommend that you turn off all devices as described in their owner's manuals. Doing so eliminates the risk of damage to the other equipment. If you do not want the instrument to turn off automatically when connected to other equipment, disable the Auto Power-Off function.

NOTICE

- **In certain modes of operation, the Auto Power-Off function will not turn off the instrument when 30 minutes has elapsed. We recommend, therefore, that you always turn off the instrument manually when you are finished using it.**
- **reface DX only:**
When the instrument is turned off by the Auto Power-Off function, any Voice settings not yet stored will be lost.

NOTE

To turn the instrument back on after it has been turned off by the Auto Power-Off function, press the [⏻] (Standby/On) switch once to return it to the Standby position, and then press it once again to set it to the On position.

■ Disabling the Auto Power-Off function

- ① Ensure that the instrument is turned off.
- ② While holding down the leftmost key on the keyboard, turn on the instrument.

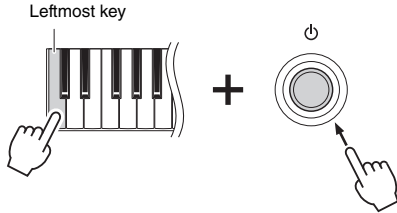

● reface CS, reface CP, and reface YC

Multiple lamps on the front panel will flash.

● reface DX

The message “Auto power off disabled” will be displayed on-screen.

- ③ When the lamps stop flashing or the message is no longer displayed, remove your finger from the keyboard.

● reface DX:

The Auto Power-Off function can also be disabled by using the [FUNCTION] button.

- ① Select the System Settings screen by pressing the [FUNCTION] button.
- ② Tap the leftmost switch in the DATA ENTRY section.
The “ON” setting for the “AUTO P.OFF” parameter at the left of the screen will change to “off.”

■ Enabling the Auto Power-Off function

To enable the Auto Power-Off function after it has been disabled, do a Factory Reset. For details, refer to “Restoring the Factory Default Settings (Factory Reset)” (page 40).

● reface DX:

The Auto Power-Off function can also be enabled by using the [FUNCTION] button.

- ① Select the System Settings screen by pressing the [FUNCTION] button.
- ② Tap the left-most switch in the DATA ENTRY section.
The “off” setting for the “AUTO P.OFF” parameter at the left of the screen will change to “ON.”

Functions of Front Panel Components

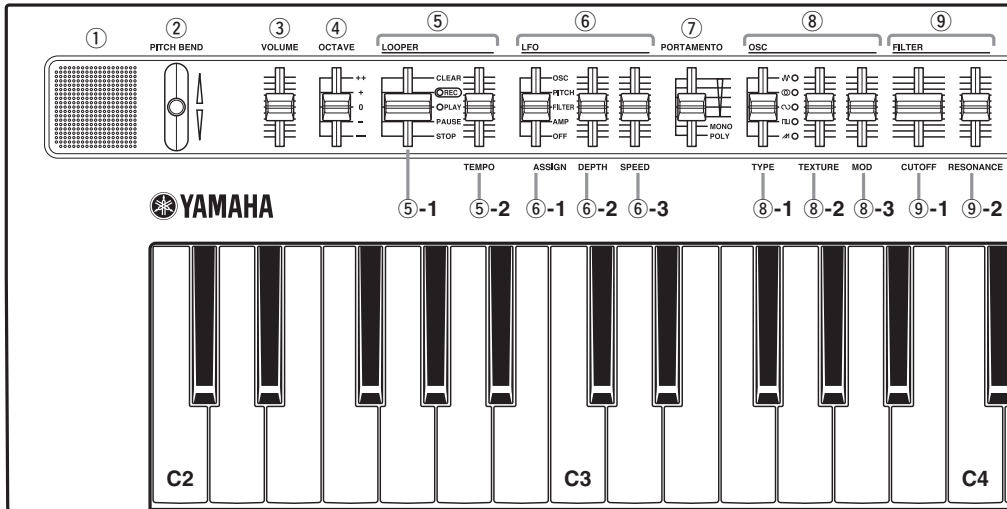

① Built-in speakers

For outputting the instrument's sounds. If you do not want sound to be output from these speakers, turn the instrument on while holding down the D2 key on the keyboard. See page 41 for details.

No sound will be output from the built-in speakers when headphones are connected.

② [PITCH BEND] lever

For smoothly varying the pitch of the instrument. The pitch rises when you move the lever up; it drops when you move the lever down. By switching the direction in which note pitches are changed by the [PITCH BEND] lever, you can produce guitar-like note bending effects when playing the reface CS as a keytar. Inverting the pitch bend range makes the pitch rise when you move the lever down and drop when you move the lever up. For details, refer to "Keyboard Settings" (page 41).

③ [VOLUME] slider

For adjusting the instrument's overall volume. When you move the slider up, the sound output from the built-in speakers, the OUTPUT [R]/[L/MONO] jacks, and the [PHONES] jack will become louder.

④ [OCTAVE] slider

For transposing the keyboard in units of 1 octave. For example, when set to "+," the note C4 will be produced when you play C3 on the keyboard (see the illustration above). The available settings are "++" (2 octaves up), "+" (1 octave up), "0" (no change in pitch), "-" (1 octave down), and "--" (2 octaves down).

⑤ LOOPER section

For operating the Phrase Looper, which can record and play back multiple, overlaid loop phrases. Phrases containing a maximum of 2,000 notes or ten minutes at 120 BPM can be temporarily recorded as MIDI data by using this section. For details on how to use the Phrase Looper, refer to page 14.

NOTE

- When you turn off the instrument, all loop phrases recorded in the Phrase Looper will be lost.
- If the total number of notes produced simultaneously by the Phrase Looper and by playing the keyboard exceeds eight, the older ones stop playing (priority is given to the newest).

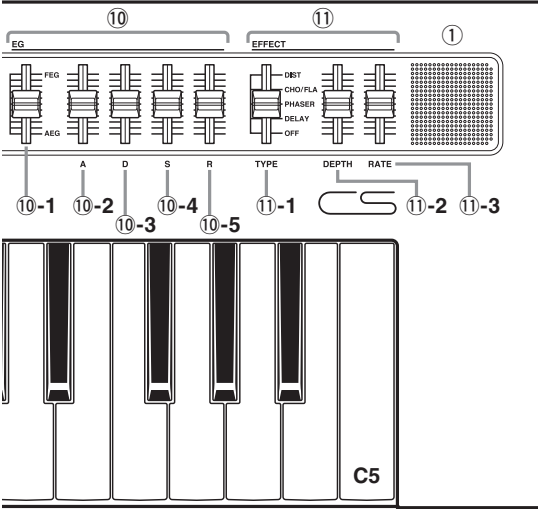

⑤-1. **LOOPER slider**

CLEAR	Deletes recorded loop phrases.
REC	<p>When recording the first phrase: Sets the Phrase Looper to Recording Standby mode. Recording will start as soon as you play the keyboard with REC selected.</p> <p>When recording the second and subsequent phrases (overdubbing): Recording will start as soon as you move the slider to the REC position.</p>
PLAY	Starts playback. When you switch from REC to PLAY, recording stops and playback of the recorded loop phrase(s) starts. When you switch from PAUSE to PLAY, loop playback will begin from the next beat. When you switch from STOP to PLAY, playback will begin from the start of the loop.
PAUSE	When you switch from PLAY to PAUSE, loop playback will be paused.
STOP	Stops playback.

⑤-2. **[TEMPO] slider**

For adjusting the tempo of loop playback. When the slider is at the very bottom, the tempo is 30 BPM; when at the very top, it is 300 BPM.

⑥ **LFO section**

For adjusting the settings of the low frequency oscillator (LFO).

⑥-1. **[ASSIGN] slider**

For selecting what to modulate with the LFO.

OSC (Oscillator)	Unique oscillator parameter will be modulated. The actual parameters modulated depend on the OSC [TYPE] slider setting.
PITCH	The pitch of the oscillator will be modulated.
FILTER	The filter cutoff frequency will be modulated.
AMP	The volume of the oscillator will be modulated.
OFF	The LFO has no effect.

⑥-2. **[DEPTH] slider**

For adjusting the depth of the LFO (the degree to which it has an effect).

⑥-3. **[SPEED] slider**

For changing the LFO's rate (or operating frequency).

⑦ **[PORTAMENTO] slider**

For setting the portamento time and the playing mode of the entire instrument.

	Sets the instrument to Mono-phononic mode and adjusts the portamento time.
MONO	Sets the instrument to Mono-phononic mode.
POLY	Sets the instrument to Poly-phononic mode. Portamento will not be applied.

⑧ OSC (Oscillator) section

For setting the oscillator(s). A voice can be created by using the three sliders in this section. In addition, the voice can be further modified by setting the LFO section's [ASSIGN] slider (⑥-1) to "OSC" and adjusting its [DEPTH] and [SPEED] sliders.

⑧-1. [TYPE] slider

⑧-2. [TEXTURE] slider

⑧-3. [MOD] (Modulation) slider

* The "LFO (OSC)" rows in the following tables indicate what can be done when the LFO section is set to "OSC."

▲ (Multi-saw)	
Description	Produces a basic synthesizer voice by using sawtooth waves. Multiple sawtooth waves can be layered to create thicker voices, or a "sub-oscillator" that plays 1 octave lower can be added to fatten the sound.
[TEXTURE]	Adds a sub-oscillator to fatten the sound.
[MOD]	Layers multiple sawtooth waves to make a thicker, more undulating sound.
LFO (OSC)	The LFO modulates the oscillator's pitch. This does not affect the sub-oscillator.
Mode of use	Ideal for the creation of trance pads, techno basses, and other similar sounds.
▮ (Pulse)	
Description	Produces a basic synthesizer voice by using square waves. Two square waves with different pitches can be layered to make the sound more complex.
[TEXTURE]	Changes the pitch of the second square wave.
[MOD]	Changes the pulse width. Raising the slider produces a distinctive thinner sound.
LFO (OSC)	The LFO modulates the pulse width. This makes it possible to create a distinctive effect known as "pulse width modulation."
Mode of use	Ideal for the creation of leads, pads, synth basses, and other similar sounds.

∞ (Oscillator Sync)	
Description	Produces voices having two oscillators (OSC1 and OSC2), with OSC2 locked in sync with OSC1. Intense harmonics can be generated by changing the pitch and tone of OSC2, making it possible to create highly distinctive, dazzling sounds.
[TEXTURE]	Changes the pitch and tone of OSC2. This makes the generated harmonics mellower.
[MOD]	Sets the degree to which the OSC2 pitch is changed.
LFO (OSC)	The LFO modulates the OSC2 pitch.
Mode of use	Ideal for lead voices used to play solos and other similar sounds.
⊗ (Ring Modulation)	
Description	Produces voices by multiplying the signals from two oscillators (OSC1 and OSC2). Metallic-sounding voices with no distinct pitch can be created by changing the pitches of the oscillators.
[TEXTURE]	Changes the pitch of OSC1.
[MOD]	Changes the pitch of OSC2.
LFO (OSC)	The LFO modulates the OSC2 pitch.
Mode of use	Ideal for extreme basses and sound effects.
∧ (Frequency Modulation)	
Description	Produces voices having two oscillators (OSC1 and OSC2), with the frequency of OSC1 modulated by OSC2. This makes it possible to create voices with intense harmonics such as those of the Yamaha DX7 and other FM synthesizers.
[TEXTURE]	Sets the degree to which modulation is applied.
[MOD]	Changes the pitch of the modulating oscillator (OSC2).
LFO (OSC)	The LFO can modulate the degree to which frequency modulation is applied.
Mode of use	Ideal for leads, synth comping voices, and sound effects. With the [MOD] slider moved all the way up, noise and electronic snare drum sounds can also be created.

⑨ **FILTER section**

For setting the filter.

⑨-1. **[CUTOFF] slider**

For setting the cutoff frequency of the low-pass filter (LPF; 24 dB per octave). The sound can be brightened by moving the slider up, or darkened by moving it down.

⑨-2. **[RESONANCE] slider**

For setting the resonance, which changes the character of the sound. This effect can be made more pronounced by moving the slider up and less pronounced by moving it down.

NOTICE

Take special care when lowering the cutoff frequency at a high resonance setting. This action can damage the speakers.

⑩ **EG section**

By using the Envelope Generator (EG), you can adjust the level (volume) of all elements of the sound from attack to release.

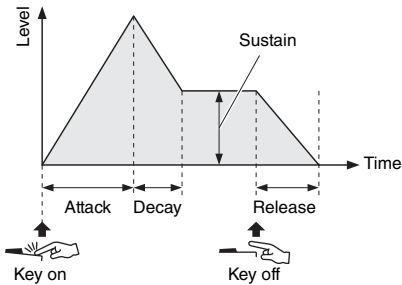

⑩-1. **EG Balance slider**

For changing the degree to which the Filter Envelope Generator (FEG) and the Amplitude Envelope Generator (AEG) affect the sound by adjusting the balance between them. The effect of the FEG can be maximized by moving the slider all the way up. The effect of the AEG can be maximized by moving the slider all the way down. The FEG will have no effect in this position. The FEG and AEG will each affect the sound by the same amount when the slider is in the middle position.

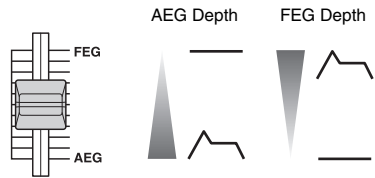

⑩-2 to ⑩-5. **[A][D][S][R] sliders**

For adjusting the attack time (A), decay time (D), sustain level (S), and release time (R) of the FEG and AEG.

⑪ **EFFECT section**

For setting the instrument's effects.

⑪-1. **[TYPE] slider**

For selecting either DIST (Distortion), CHO/FLA (Chorus/Flanger), PHASER, DELAY, or OFF. In the OFF position, the sound passes through without being affected in any way.

⑪-2. **[DEPTH] slider**

For setting the effect depth (how much it affects the sound).

⑪-3. **[RATE] slider**

For setting the tone when the EFFECT section's [TYPE] slider is set to "DIST"; the rate when it is set to "CHO/FLA" or "PHASER"; or the delay time when it is set to "DELAY."

Using the Phrase Looper

The Phrase Looper can be used to record and play loop phrases. With this feature, you can overdub to record multiple phrases on top of one another, or you can choose loop playback to repeat the recorded phrases over and over. In addition to changing the tempo after making a recording, the Phrase Looper on the reface CS lets you control the sound using the sliders from other sections such as OSC, FILTER, and EG.

Playing with the Phrase Looper

The Phrase Looper can record up to 2,000 notes or ten minutes at 120 BPM.

NOTE

Loop phrases will be lost when this instrument is turned off.

■ Starting a new loop phrase recording

1. Get the Phrase Looper ready.

- ① Set the LOOPER slider to “CLEAR.”
Any currently recorded loop phrases will be deleted, and the Phrase Looper will be set up for recording a new loop phrase.

2. Record the first phrase.

- ① Set the LOOPER slider to “REC.”
The Phrase Looper is set to Recording Standby. In time with the tempo, a guide sound is produced and the “REC” lamp flashes.
You can adjust the tempo by using the [TEMPO] slider.
The guide sound is produced only when recording the first phrase. If you do not wish to hear the guide sound, move the LOOPER slider from “CLEAR” to “PLAY” before setting it to “REC.”
The current voice is used for the guide sound. If you change the voice by using the sliders, the guide sound also changes.

- ② Play the phrase you wish to record by using the keyboard.
When recording the first phrase, the instrument will start recording as soon as you play the first note. On the reface CS, the Key-on Start function is the only way to start recording in this situation.
When recording starts, the “REC” lamp will light up and the “PLAY” lamp will flash.
- ③ When you wish to end recording, set the LOOPER slider to “PLAY.”
Recording will stop, and the recorded phrase will start to play as a loop. During loop playback, the “PLAY” lamp will flash in time with the tempo. The guide sound is not produced during loop playback.

3. Record an overdub.

The recording of overdubs will begin as soon as you move the LOOPER slider to “REC.” The guide sound is not produced when overdubbing.

- ① Set the LOOPER slider to “REC” once again.
- ② Play the phrase you wish to overdub on the keyboard along with the phrase(s) currently being played.
- ③ When you wish to end recording, set the LOOPER slider to “PLAY.”
Recording will stop, and the overdubbed phrases that were recorded will play as a loop.

If necessary, you can repeat the overdubbing process.

NOTE

- Once you reach 2,000 notes, no additional events will be recorded with the LOOPER slider set to “REC.”
- If you exceed the maximum polyphony, the older notes will be overwritten with newer notes (priority is given to the newest).

● Changing the sound of loop phrases

You can use the sliders from the LFO, PORTAMENTO, OSC, FILTER, EG, and EFFECT sections to control the sound of the recorded loop phrases as you play them back.

● Stopping loop phrases

● Pausing

Move the LOOPER slider from “PLAY” to “PAUSE.”

Looped playback of the phrases will be paused.

When you switch to “PLAY” once again, playback will restart from the position at which it was paused.

● Stopping

Move the LOOPER slider from “PLAY” to “STOP.”

Looped playback of the phrases will be stopped.

When you switch to “PLAY” once again, playback will start from the beginning of the phrases.

Functions of Front Panel Components

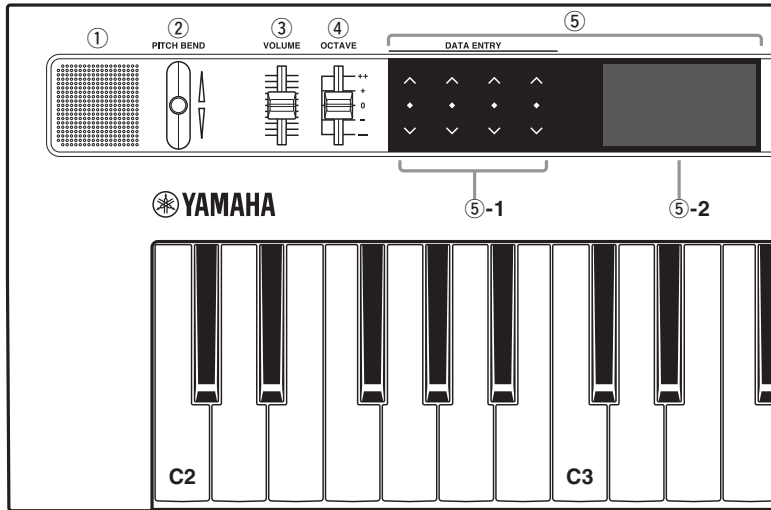

① Built-in speakers

For outputting the instrument's sounds. If you do not want sound to be output from these speakers, turn the instrument on (page 8) while holding down the D2 key on the keyboard. See page 41 for details.

No sound will be output from the built-in speakers when headphones are connected. You can also press the [FUNCTION] button to call up the System Settings screen and change the Speaker Output setting.

② [PITCH BEND] lever

For smoothly varying the pitch of the instrument. The pitch rises when you move the lever up; it drops when you move the lever down. Pitch bend can be set for individual Voices.

By switching the direction in which note pitches are changed by the [PITCH BEND] lever, you can produce guitar-like note bending effects when playing the reface DX as a keytar. Inverting the pitch bend range makes the pitch rise when you move the lever down and drop when you move the lever up.

On the reface DX, pitch bend settings can be changed by using the [FUNCTION] button.

③ [VOLUME] slider

For adjusting the instrument's overall volume. When you move the slider up, the sound output from the built-in speakers, the OUTPUT [R]/[L/MONO] jacks, and the [PHONES] jack will become louder.

④ [OCTAVE] slider

For moving the range of notes covered by the keyboard in units of 1 octave. For example, when set to "+," the note C4 will be produced when you play C3 on the keyboard (see the illustration above). The available settings are "++" (2 octaves up), "+" (1 octave up), "0" (no change in pitch), "-" (1 octave down), and "--" (2 octaves down).

⑤ DATA ENTRY section

⑤-1. Touch-type sliders or switches

By flicking, tapping, or tapping and holding these four touch-sensitive areas, which operate as sliders or switches, you can adjust values and change settings. The screen on the right shows the parameters that can be set. Thanks to multi-touch support, meanwhile, you can simultaneously control up to four sliders

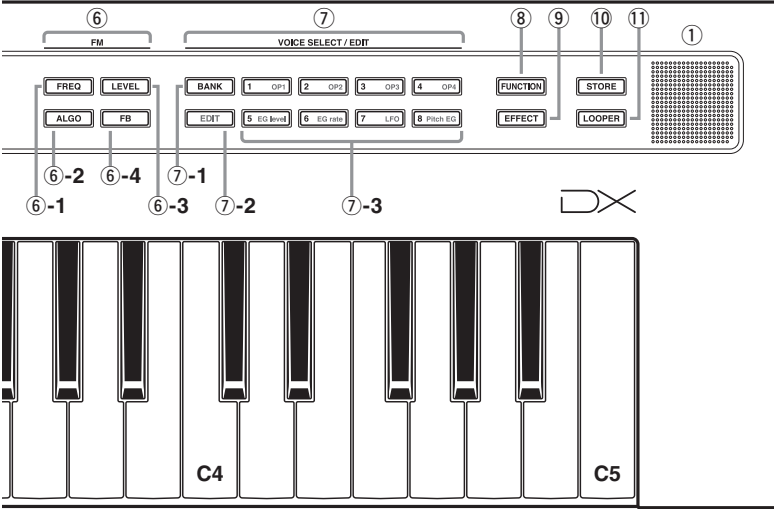

● Basic operation

Flick

A “flick” is a sudden, quick movement of your finger along a slider. Depending on the speed of the flick, the value corresponding to the slider will be changed by a small or large amount. We recommend that you use your index finger for flicking.





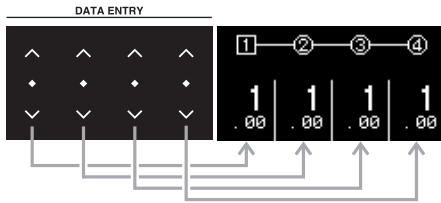

Tap
Tap and hold

A “tap” is a single, quick touch and release of the slider. If you do not release when you tap (tap and hold), the value corresponding to the slide will continue to change until you do so. (Auto Repeat function)

Tap the top
Tap and hold the top
Tap the bottom
Tap and hold the bottom
Tap a switch to operate it.

When you operate a slider, the change will be displayed on-screen.



Type	Settings	Mode of use
	Values	Flick upward to increase the value; flick downward to decrease it. Flick quickly to change the value by a large amount; flick slowly to change it by a small amount. Tap “  ” or “  ” to change the value in units of one. Tap and hold “  ” or “  ” to change the value continuously.
	On and off Type selection	Tap “  ” to toggle between on and off or to switch types, etc.

⑤-2. Display

For displaying settings. The screen itself is not touch-sensitive. When a setting screen contains multiple pages, they are indicated in the form “●○○○” (page 1 of 4 pages).

⑥ FM section

For changing the sound by modifying some of the FM tone generator’s more distinctive parameters. When you press a button in the FM section, it will light up to indicate that the corresponding item can be set. You can then use the DATA ENTRY sliders to change the settings of individual parameters.

The FM tone generator

FM stands for “frequency modulation.” This type of tone generator modulates the frequency of a sound’s fundamental waveform of a sound with a different waveform to produce a totally new one. Waveforms are generated by “operators,” of which the reface DX has four. An operator that generates a fundamental waveform is a “carrier,” and an operator that modulates these waveforms is a “modulator.” Each of the four operators can be used as either a carrier or a modulator. By changing the way operators are combined and further modulating with other elements such as levels and envelopes, you can make sounds change in a highly complex fashion.

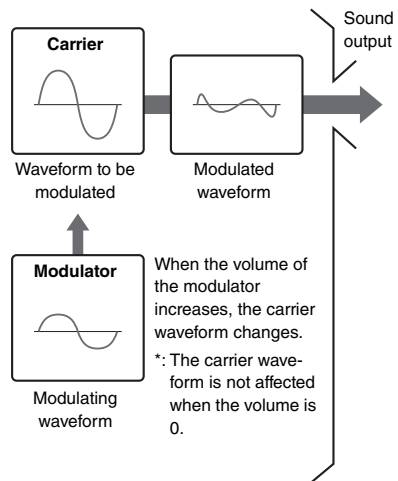

⑥-1. [FREQ] (frequency) button

For displaying the Operator Frequency Settings screen. If you flick at a certain speed or greater, the setting will change to the closest integer value. For example, if the current setting is 9.29 and you flick quickly upward, the value will change to 10.00.



Frequencies can be specified as either a ratio or a fixed frequency. Refer to the “Reference Manual” (a digital manual) for details on the setting procedure.

NOTICE

Take special care when setting a low carrier frequency in FIXED mode as this action can damage the speakers.

⑥-2. [ALGO] (Algorithm) button

For displaying the Algorithm Setting screen. On this screen, you can specify how the four operators should be combined. A total of 12 algorithms are available.

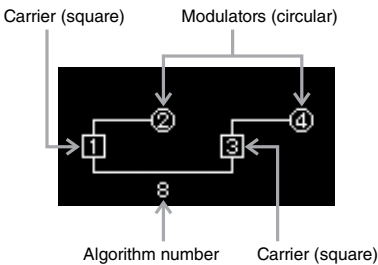

⑥-3. [LEVEL] button

For displaying the Operator Level Settings screen. On this screen, you can adjust the volume (for carriers) or the degree to which the corresponding carrier is modulated (for modulators).



⑥-4. [FB] (Feedback) button

For displaying the Feedback Settings screen. Waveforms can be changed by feeding some of the signal generated by an operator back through that operator.

The reface DX allows you to set feedback levels for each of the operators. If, for example, you were to select Algorithm No. 8 and apply feedback to all of the operators, the signal flow would be as follows.

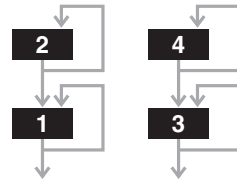

Feedback level



If you move the slider up from the center position, the feedback type becomes sawtooth (▲) and the feedback level will increase. As a result, the waveform morphs from a sine to a sawtooth shape, and at the maximum level, it is transformed fully into a sawtooth wave. If you move the slider down from the center position, the feedback type becomes square (■) and the feedback level will increase. As a result, the waveform morphs from a sine to a square shape, and at the maximum level, it is transformed fully into a square wave. At the center position, the feedback level is “0.” Here, none of the signal is fed back and a sine wave is produced.

⑦ **VOICE SELECT/EDIT section**

For recalling a total of 32 Voices by changing Bank numbers (1 to 4) and Voice numbers (1 to 8).

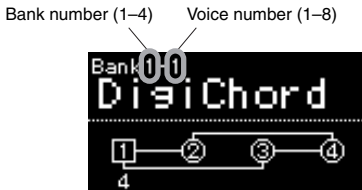

⑦-1. **[BANK] button**

For changing the bank number. Each time you press this button, the number cycles through 1 to 4.

⑦-3. **[1]–[8] buttons**

For selecting one of eight Voices from the selected Bank.

⑦-2. **[EDIT] button**

For activating Edit mode for the selected Voice. In this mode, you can edit sounds by setting the EG level, LFO, and other parameters from area ⑦-3.

NOTE

If you open the Job screen by pressing the [FUNCTION] button and then do a Voice Initialize, you can start editing with parameters set so as to produce a sine wave.

⑦-3. **[OP1]–[OP4], [EG level], [EG rate], [LFO], and [Pitch EG] buttons**

[OP1]–[OP4]: For displaying the setting screen for the corresponding operator. These buttons can be pressed repeatedly to cycle through the screen's individual pages.

[EG level]: For displaying the EG Level Settings screen for operators. This button can be pressed repeatedly to cycle through the four operators.

[EG rate]: For displaying the EG Rate Settings screen. This button can be pressed repeatedly to cycle through the four operators.

[LFO]: For displaying the LFO Settings screen. This button can be pressed repeatedly to cycle through the screen's individual pages.

[Pitch EG]: For displaying the Pitch EG Settings screen. This button can be pressed repeatedly to cycle through the screen's individual pages.

For details regarding the [EDIT] button (⑦-2) and the [OP1] to [Pitch EG] buttons (⑦-3), refer to the "Reference Manual" (a digital manual).

⑧ [FUNCTION] button

When pressed, the button's lamp lights up and Function mode is activated. In this condition, the button can be pressed repeatedly to cycle through the mode's individual pages. When you press a different button, the lamp goes out and the instrument leaves Function mode. In Function mode, you can set Voice Parameter, MIDI, System, and Job parameters.

● Page 1: Voice Parameter Settings screen

For setting the way sounds are produced for each Voice.

Whenever you store a Voice by using the [STORE] button, Voice parameter settings are stored.



TP (Transpose)	-24- +24	Adjusts the pitch in semitone units.
MONO/POLY	POLY	Sets the Voice to Polyphonic mode.
	MONO-FULL	Sets the Voice to Monophonic mode. Portamento will be applied to all notes.
	MONO-LGATO (Mono-Legato)	Sets the Voice to Monophonic mode. Portamento will be applied only to notes played legato.
PORTA (Portamento Time)	0-127	Set the portamento time.
PB (Pitch Bend Range)	-24- +24	Sets the pitch bend range in semitone units.

● Page 2: MIDI Settings screen



TR CH (MIDI transmit channel)	1-16, off	Sets the MIDI transmit channel. When set to "off," no data is transmitted.
RV CH (MIDI receive channel)	All, 1-16	Sets the MIDI receive channel. When set to "ALL," data is received on all channels.
CONTROL	ON, off	Sets whether or not MIDI Control is to be used. MIDI Control Change messages specifically for the reface will be transmitted if a setting is changed in the FM section ([FREQ], [LEVEL], [ALGO], and [FB] buttons) while MIDI Control is turned on. If these messages are received, the FM section's settings will change accordingly.
LOCAL (Local Control)	ON, off	Turns Local Control on or off. When set to "off," the reface's internal tone generator and keyboard are disconnected from one another; when set to "ON" they are connected.

DX

● Page 3: System Settings screen



AUTO P.OFF (Auto Power-Off)	ON, off	Activates or deactivates the Auto Power-Off function.
SP (Speaker Output)	ON, off	Sets whether or not sound is to be output from the speakers.
SUSTAIN	FC3, FC4/5	Sets the type of sustain pedal connected to the instrument. If using a pedal that supports half-damper operation, set this to "FC3."
CONTRAST	0-63	Adjusts the contrast of the instrument's display.

● Page 4: Job screen



EDIT RECAL (Edit Recall)	Returns the currently selected Voice to the last edited condition. This may be necessary if you have moved to a different Voice while editing.
VOICE INIT (Voice Initialize)	Sets the selected Voice to the default condition (a sine wave).
VOICE RECALL	Returns the currently selected Voice to the factory default settings.
FCTRY RESET (Factory Reset)	Returns all of the instrument's parameters to the factory default settings.

⑨ [EFFECT] button

For displaying the Effect Settings screen. On this screen, two different Insert Effects can be configured. Each time the button is pressed with the Effect Settings screen displayed, the screen toggles between Effect 1 and Effect 2 parameters.

Example: Effect 1 Settings screen

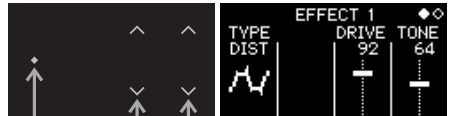

Switch Sliders

When you select an effect type by using the switch on the left, the editable parameters corresponding to that effect will be displayed on the right of the screen. Flick or tap the parameters' sliders to change their settings.

● Effect types

THRU	THRU	No effects are applied.
DIST	DIST	Distortion is applied. DRIVE and TONE can be adjusted.
T.WAH	T.WAH	Touch wah is applied. SENS and REZ can be adjusted.
CHO	CHO	Chorus is applied. DEPTH and RATE can be adjusted.
FLA	FLA	A flanger is applied. DEPTH and RATE can be adjusted.
PHA	PHA	A phaser is applied. DEPTH and RATE can be adjusted.
DLY	DLY	Delay is applied. DEPTH and TIME can be adjusted.
REV	REV	Reverb is applied. DEPTH and TIME can be adjusted.

⑩ **[STORE] button**

For displaying the Store Settings screen. On this screen, you can specify where to store settings and store them with a name. When you store a Voice, it overwrites the Preset Voice stored in the selected location. If you wish to restore Preset Voices, do a Voice Recall (page 22) or a Factory Reset (page 22 or 40).

When you press this button, the Store screen will be displayed.

● **Store screen**



name		Switches to the Store Name screen.
STORE TO	Bank 1-1 to 4-8	Sets where to store the current Voice. NOTE The [BANK] button and buttons [1]–[8] can also be used to make this setting.
	CHECK	Used if you wish to listen to the Voice at the location selected for storing. Tap the switch to toggle between CHECK and . CHECK : When you play the keyboard, you will hear the Voice selected for storing. : When you play the keyboard, you will hear the Voice stored at the location selected by using “STORE TO BANK.”

STORE	Used to store Voices. When you tap the switch, a confirmation message will be displayed on-screen.
	<p>Tap the “YES” switch to store the Voice. Tap the “NO” switch to return to the Store screen without storing any data.</p>

● **Store Name screen**



store		Switches back to the Store screen.
←		Moves the cursor to the left.
ABC	Upper-and lower-case letters and symbols	Tap the switch to display the Name Input screen. On this screen, you can input a new Voice name by flicking and tapping the slider to select letters and symbols.
		→

⑪ **[LOOPER] button**

For displaying the Phrase Looper screen. On this screen, you can operate the MIDI looper, recording, overdubbing, and playing back loop phrases. By using this section, phrases containing a maximum of 2,000 notes or ten minutes at 120 BPM can be temporarily recorded.

Using the Phrase Looper

The Phrase Looper can be used to record and play loop phrases. With this feature, you can overdub to record multiple phrases on top of one another, or you can choose loop playback to repeat the recorded phrases over and over. The Phrase Looper on the reface DX lets you change the tempo of recorded loop phrases and control the sound by using the FM and VOICE SELECT/EDIT sections.

Press the [LOOPER] button to use the Phrase Looper.

Playing with the Phrase Looper

The Phrase Looper can record up to 2,000 notes or ten minutes at 120 BPM.

NOTE

Loop phrases will be lost when this instrument is turned off.

■ Starting a new loop-phrase recording

1. Start the Phrase looper.

- ① Press the [LOOPER] button.
The Phrase Looper screen will be displayed.



You can turn the guide sound on and off by tapping the “GUIDE” switch.

2. Record the first phrase.

- ① Tap the “REC” switch from the DATA ENTRY section.



The Phrase Looper is set to Recording Standby. In time with the tempo, a guide sound is produced and the slider and the [LOOPER] button flash.



The current voice is used for the guide sound. If you change the voice by using the sliders or buttons, the guide sound also changes.

You can adjust the tempo by using the [TEMPO] slider.

- ② Play a phrase on the keyboard.
When recording the first phrase, the instrument’s Key-on Start function will start recording as soon as you play the first note. If you wish to record silence at the start of the phrase, you can tap “REC START” before playing the keyboard to start recording.

During recording, the slider and the [LOOPER] button flash in time with the tempo, and the total number of beats is incremented on-screen.



- ③ When you wish to end recording, tap “REC STOP.”



Recording will stop, and the recorded phrase will play as a loop. The guide sound is not produced during loop playback.

During loop playback, the slider and the [LOOPER] button will flash in time with the tempo, and the current beat will be displayed on-screen together with the total number of recorded beats. In addition, the position indicator at the top of the display allows you to confirm the current position during loop playback.

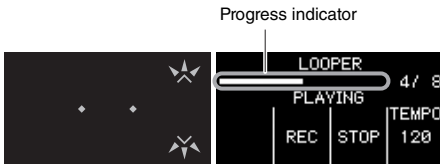

3. Record an overdub.

The recording of overdubs will begin as soon as you tap “REC.” The guide sound is not produced when overdubbing.

NOTE

When you stop playback of the first phrase, the Phrase Looper is set to Recording Standby. If you tap “REC START” in that condition, the Key-on Start function starts recording.

- ① Tap “REC” or “REC START.”
- ② Play the phrase you wish to overdub on the keyboard along with the phrase(s) currently being played.
- ③ When you wish to end recording, tap “REC STOP.”
Recording will stop, and the recorded, overdubbed phrases will play as a loop.

If necessary, you can repeat the overdubbing process.

NOTE

- Once you reach 2,000 events, the message “Looper Memory Full” is displayed on-screen and no additional events are recorded after tapping “REC.”
- If you exceed the maximum polyphony, the older notes will be overwritten with newer notes (priority is given to the newest).

● Changing the sound of loop phrases

You can use the FM and VOICE SELECT/EDIT sections to control the sound of the recorded loop phrases as you play them back. Regardless of the screen currently displayed, the [LOOPER] button will continue to flash during looped playback.

● Stopping loop phrases

● Stopping

Tap the “STOP” switch.

Looped playback of the phrases will be stopped.



When you wish to restart a paused phrase, tap the “PLAY” switch.

Recorded phrases start from the beginning when played as loops.



Deleting loop phrases

Recorded loop phrases can be deleted by tapping the “CLEAR” switch with loop-phrase playback stopped.



This will delete all recorded phrases.

Functions of Front Panel Components

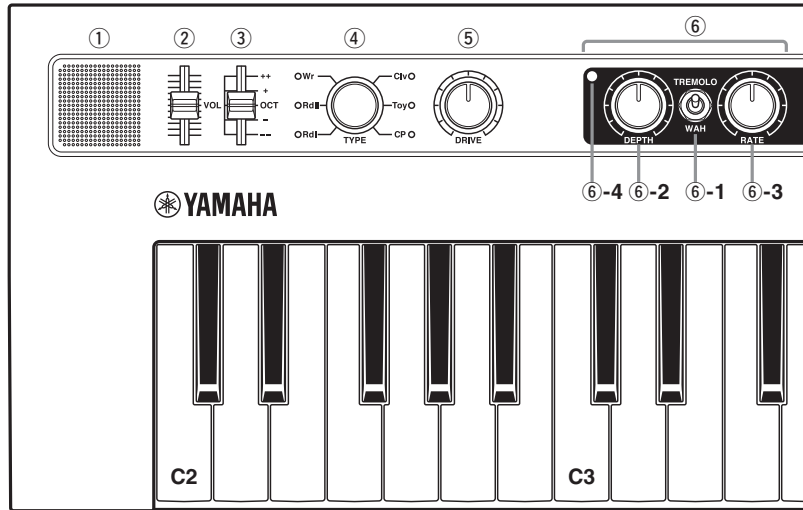

① Built-in speakers

For outputting the instrument's sounds. If you do not want sound to be output from these speakers, turn the instrument on while holding down the D2 key on the keyboard. See page 41 for details.

No sound will be output from the built-in speakers when headphones are connected.

② [VOL] (Volume) slider

For adjusting the instrument's overall volume. When you move the slider up, the sound output from the built-in speakers, the OUTPUT [R]/[L/MONO] jacks, and the [PHONES] jack will become louder.

③ [OCT] (Octave) slider

For transposing the keyboard in units of 1 octave. For example, when set to "+," the note C4 will be produced when you play C3 on the keyboard (see the illustration above). The available settings are "++" (2 octaves up), "+" (1 octave up), "OCT" (no change in pitch), "--" (1 octave down), and "--" (2 octaves down).

④ [TYPE] knob

For selecting different voice types.

Rdl	Sets a distinctive electric piano voice from the early 1970s. This type of electric piano is characterized by a dark, heavy sound with sustained notes. It sounds particularly good when combined with the phaser effect and was widely used in 70s jazz, R&B, and soul.
RdlI	Sets a distinctive electric piano voice from the late 1970s. Compared with the Rdl, it has a characteristically bright, high-fidelity sound. It sounds particularly good when combined with the chorus or phaser effect and was primarily used in the pop ballads and fusion music of the 80s.
Wr	Sets a distinctive electric piano voice that became famous in the late 1960s. This type of electric piano is notable for the gentle attack and fast decay of flat metal reeds. Often combined with a tremolo effect, it was widely used in 70s pop, R&B, and soul.

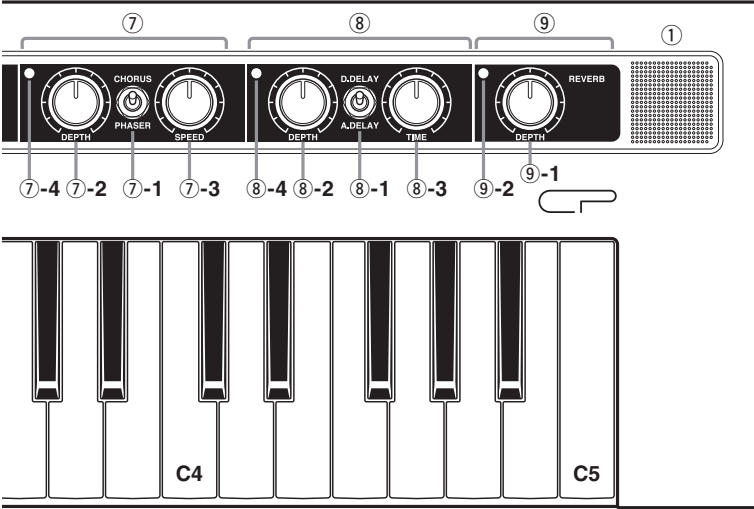

Clv	Sets the voice of a struck-string type of electric keyboard that arrived on the scene in the 1970s. Its electric guitar-like sound is highly distinctive. This voice works very well with a wah effect and was primarily used in the funk and rock music of the 70s.
Toy	Sets the voice of a vintage toy piano from the 1970s. This setting combines a bright, undulating tone with the distinctive noisy keyboard of toy pianos. Although originally developed as a child's toy, this type of instrument has recently found its way into popular music thanks to its highly unique sound.
CP	Sets the voice of the Yamaha CP80 electric grand piano of the late 1970s. The CP80 was notable for a fast attack similar to that produced by using compression, and also for its unique harmonic overtones. It works very well with a chorus effect and was used in the pop, rock, jazz, and fusion music of the 80s.

⑤ [DRIVE] knob

For distorting the sound, thereby reproducing the effect of a guitar amp or an old radio. Turning the knob clockwise increases the amount of distortion and produces a brighter tone. When the knob is turned all the way counter-clockwise, no effect is applied to the sound.

⑥ TREMOLO/WAH

The reface CP features four Insert Effects arranged in series. The TREMOLO/WAH section lets you add a tremolo or wah effect.

● TREMOLO

Modulates the volume in a cyclical fashion.

When [TYPE] is set to Rdl, Rdll, or CP:

The sound will be cyclically panned left and right in stereo.

When [TYPE] is set to Wr, Clv, or Toy:

The volume will be cyclically varied up and down.

● WAH

Modulates the filter cutoff frequency based on the input volume. This produces a cyclical change in tone.

⑥-1. [TREMOLO/WAH] switch

For selecting whether to add tremolo (up position), add wah (down position), or pass the sound through unaffected (middle position).

The lamp (⑥-4) will light up when either tremolo or wah is selected and go out when the sound passes through unaffected.

⑥-2. [DEPTH] knob

Increases the effect on the sound when turned clockwise.

● With tremolo

When [TYPE] is set to Rdl, Rdll, or CP:

Adjusts the degree to which the sound is modulated left and right.

When [TYPE] is set to Wr, Clv, or Toy:

Adjusts the degree to which the volume is modulated.

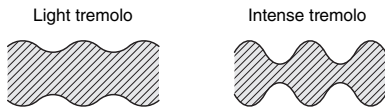

● With wah

Adjusts the sensitivity of the wah filter.

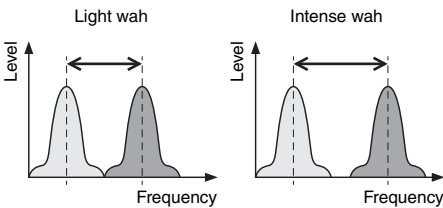

⑥-3. [RATE] knob

Increases the effect on the sound when turned clockwise.

● With tremolo

Adjusts the speed of modulation.

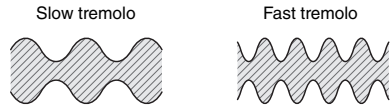

● With wah

Adjusts the resonance offset value. This changes the character of the modulated sound.

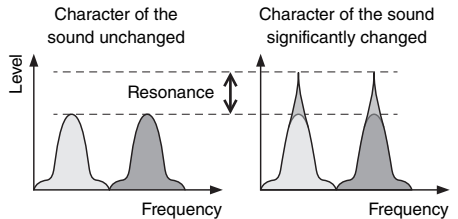

⑦ CHORUS/PHASER

This section lets you add a chorus or phaser effect.

● CHORUS

Adds richness and depth, making it sound like multiple tone generators are simultaneously outputting the same voice. This makes the voice sound much wider.

● PHASER

Creates a highly distinctive sweeping, swelling tone by shifting the phase of the sound and mixing it back into the original signal.

⑦-1. [CHORUS/PHASER] switch

For selecting whether to add chorus (up position), add the phaser effect (down position), or pass the sound through unaffected (middle position). The lamp (⑦-4) will light up when either chorus or the phaser is selected and go out when the sound passes through unaffected.

⑦-2. [DEPTH] knob

For adjusting the degree to which the chorus or phaser effect is applied. Turn the knob clockwise to increase the depth of the effect.

⑦-3. [SPEED] knob

For adjusting the speed at which the sound undulates. Turn the knob clockwise to increase the speed.

⑧ D. DELAY/A. DELAY (Digital Delay / Analog Delay)

This section lets you add either digital or analog delay to the sound.

Delay effects create a delayed version of the input signal, and as such, they can be used for many different purposes, such as creating a sense of spaciousness or thickening a sound.

● D. DELAY (Digital Delay)

Compared with analog delay, this effect produces delay sounds that are more exact replicas of the original.

● A.DELAY (Analog Delay)

Simulates the warm delay sound of analog gear.

⑧-1. [D.DELAY/A.DELAY] switch

Set this three-position switch to the up position for Digital Delay, to the down position for Analog Delay, or to the middle position to pass the sound through unaffected.

The lamp (⑧-4) will light up when either digital or analog delay is selected and go out when the sound passes through unaffected.

⑧-2. [DEPTH] knob

For adjusting the degree to which delay is applied. Turn the knob clockwise to increase the depth of the effect.

⑧-3. [TIME] knob

For adjusting the length of the delay. Turn the knob clockwise to increase the length.

⑨ REVERB section

This section can model complex reverberation to artificially create a sense of space.

The lamp (⑨-2) will light up when reverb is applied and go out when the sound passes through unaffected.

⑨-1. [DEPTH] knob

For adjusting the degree to which the reverb effect is applied. Turn the knob clockwise to increase the depth of the effect. When the knob is turned all the way counter-clockwise, no effect is applied to the sound.

Voice Setting Examples

The following settings are recommended for the reface CP.

■ Rd I

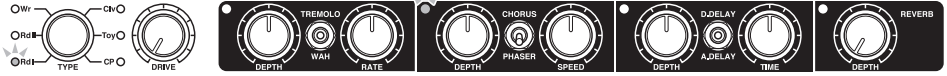

Perfect settings for the pop, soul, and fusion music of the 70s. You may like to raise the DRIVE setting to increase the distortion, to move the phaser's DEPTH setting to a relatively high level between 6 and 7, or to turn on the tremolo and move each of the DEPTH and RATE settings to around 5.

■ Rd II



These wet-sounding settings are ideal for 80s ballads and the like. You could try changing the chorus DEPTH and SPEED settings.

■ Wr



Perfect settings for playing 70s pop and the like. You might like to add some short reverberation by turning on A.DELAY and setting DEPTH to roughly 5 and TIME to roughly 1.5.

■ Clv



Ideal settings for 70s funk and rock performances. You may like to raise the DRIVE to get a distorted guitar-like sound. It could also sound good to switch from wah to tremolo and apply a little reverb.

■ Toy



Simple settings are probably the best choice for the toy piano. You might, however, like to raise the DRIVE setting to 5 or even 10 to get a vintage, radio-like sound.

■ CP



These settings are great for 80s pop and the like. The chorus setting is quite light. If necessary, you could add presence in the high-frequency band by raising the DRIVE setting to around 5. In addition, it might sound good to turn on D.DELAY and set both DEPTH and TIME to 1.5.

Functions of Front Panel Components

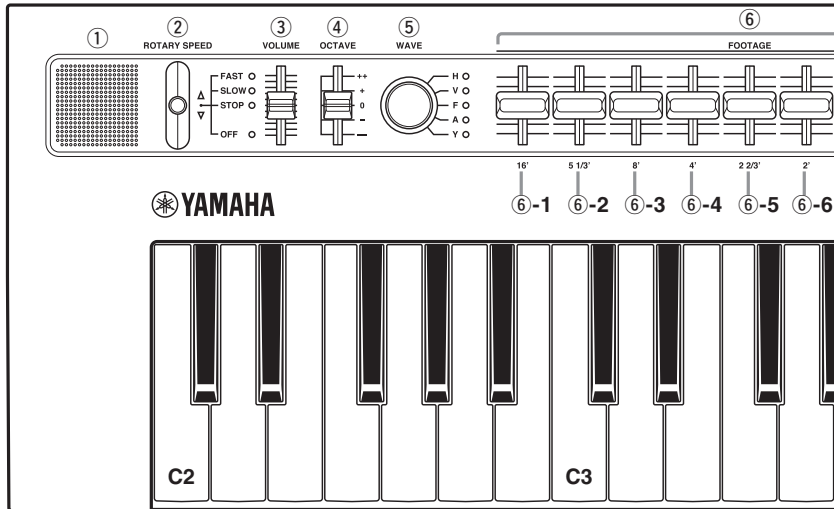

① Built-in speakers

For outputting the instrument's sounds. If you do not want sound to be output from these speakers, turn the instrument on while holding down the D2 key on the keyboard. See page 41 for details.

No sound will be output from the built-in speakers when headphones are connected.

② [ROTARY SPEED] lever

For switching the rotary speaker speed. Moving the lever up or down changes the setting between "FAST" (fast rotation), "SLOW" (slow rotation), "STOP" (no rotation), and "OFF" (no effect applied).

Examples:

To switch from "SLOW" to "FAST":

Move up once.

To switch from "SLOW" to "OFF":

Move down twice.

③ [VOLUME] slider

For adjusting the instrument's overall volume. When you move the slider up, the sound output from the built-in speakers, the OUTPUT [R]/[L/MONO] jacks, and the [PHONES] jack will become louder.

④ [OCTAVE] slider

For transposing the keyboard in units of 1 octave. For example, when set to "+," the note C4 will be produced when you play C3 on the keyboard (see the illustration above). The available settings are "++" (2 octaves up), "+" (1 octave up), "0" (no change in pitch), "-" (1 octave down), and "--" (2 octaves down).

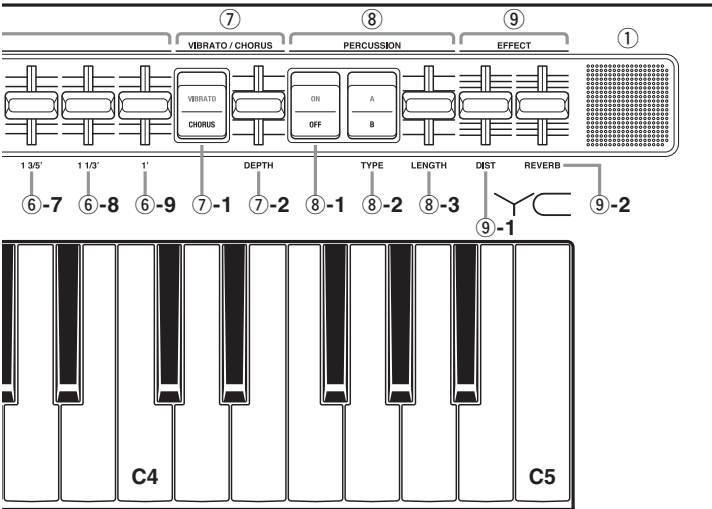

⑤ [WAVE] knob

For selecting the organ voice type.

H	Sets a distinctive electric organ sound from the 1960s, characterized by sine-like waveforms that are simple yet warm. This sound was used in many genres of music, such as rock, pop, and jazz.
V	Sets the sound of a transistor organ from the 1960s. With harmonic content very close to that of a square wave, it is notable for highly present tones. This type of organ was often used in psychedelic rock and ska.
F	Sets the sound of a transistor organ from the 1960s. This organ is notable for a thick sound with its sawtooth component boosted in volume. It was put to use in 60s pop music and the alternative pop of the 90s.
A	Sets the sound of a transistor organ made in Japan during the 1970s. This organ was notable for a bright sound similar to that produced by the sawtooth waveforms of a synthesizer.
Y	Sets the sound of a Yamaha transistor organ that was released in 1972. With harmonic content very close to that of a square wave, it was characterized by highly present tones in the high range and extreme sound crushing when distortion was increased.

⑥ FOOTAGE section

Used by moving the sliders downwards in the same way as vintage organs. To create the organ tone you desire, you can move each of these sliders to change the component elements of the sound.

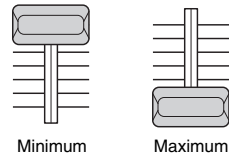

NOTE

No organ sound will be produced if all of the FOOTAGE sliders are moved all the way up.

The tones produced by moving each of the sliders are as follows.

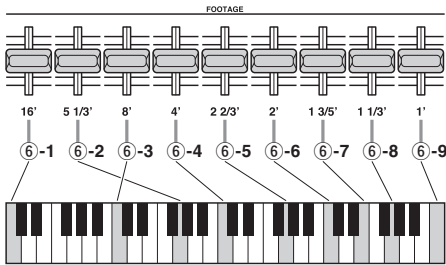

	Sliders	Tone
⑥-1	16'	8 scale degrees below
⑥-2	5 1/3'	5 scale degrees above
⑥-3	8'	Fundamental tone
⑥-4	4'	8 scale degrees above
⑥-5	2 2/3'	12 scale degrees above
⑥-6	2'	15 scale degrees above
⑥-7	1 3/5'	17 scale degrees above
⑥-8	1 1/3'	19 scale degrees above
⑥-9	1'	22 scale degrees above

*: When the [OCTAVE] slider is moved down, the 16' pitch may be too low to be heard via the built-in speakers.

⑦ VIBRATO/CHORUS section

This section can apply an undulating effect to the sound.

⑦-1. [VIBRATO/CHORUS] switch

For switching between vibrato and chorus to apply different types of undulating effects. Press down the side corresponding to the effect you wish to use.

⑦-2. [DEPTH] slider

For adjusting the degree to which vibrato or chorus is applied. Moving this slider all the way down turns off the vibrato or chorus effect.

⑧ PERCUSSION section

When turned on, an accent can be applied to the attack portion of the sound. When all of the FOOTAGE volumes are zero (that is, the sliders are moved all the way up), only these percussion sounds will be produced. The settings "A" and "B" change the pitch of the percussion.

NOTE

Regardless of the slider position, FOOTAGE [1'] does not produce any organ tones when the WAVE knob is set to "H" and PERCUSSION is turned on. In addition, when notes are played legato with the H-type organ, the volume of the percussion sound decays over those notes.

⑧-1. [ON/OFF] switch

For turning the percussion sounds on and off. When the off side is pressed down, no percussion sounds will be produced.

⑧-2. [TYPE] switch

For switching the percussion pitch type. Press down the side for either Type A or Type B.

⑧-3. [LENGTH] slider

For adjusting the length of the percussion sounds' release.

⑨ EFFECT section

For applying effects. When the sliders are moved all the way down, no effects will be applied.

⑨-1. [DIST] slider

For applying distortion.

⑨-2. [REVERB] slider

For applying reverb.

Voice Setting Examples

The following settings are recommended for the reface YC.

■ H Type 1

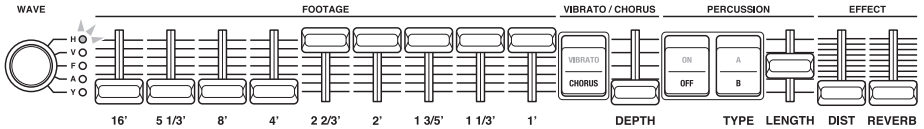

These settings can be used in rock, jazz, and a wide range of other musical genres. You might like to move the [4'] slider up for a more refined sound or to move each of the [2 2/3'], [2'], [1 3/5'], [1 1/3'], and [1'] sliders down to produce a brighter sound characteristic of rock music. Try both SLOW and FAST rotary speeds, and add distortion and reverb to taste.

■ H Type 2

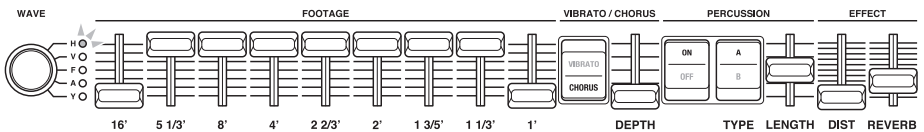

Settings like these are often used for bossa nova and reggae music. The fact that the H-type organ produces no [1'] tones when percussion is turned on is a distinctive feature of this sound. Turning percussion on and off while playing allows the [1'] tones to be added and removed in a unique way.

■ V Type

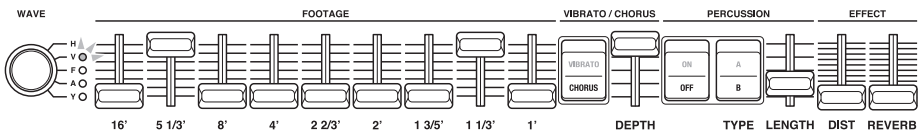

These settings are ideal for psychedelic rock and the like. Try raising the DIST setting to increase the distortion.

■ F Type

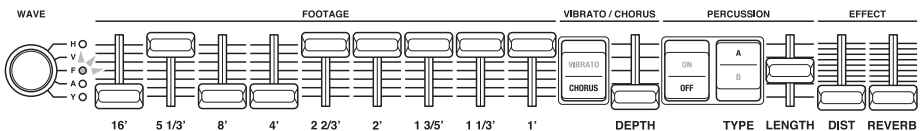

Ideal settings for an alternative rock band with a slightly vintage sound. Try raising the DIST setting to increase the distortion.

YC

Connecting to Other Devices

Connecting your reface to another MIDI device (such as a keyboard or tone generator module) expands its performance features and allows you to do the following.

- Play the reface from a MIDI keyboard
- Play a tone generator module by using the reface
- Synchronize the Phrase Loopers of a reface CS and reface DX

In addition, if you connect your reface to a computer, you can also make use of the following additional recording and playing features.

- Record performances on the reface as MIDI data in a DAW application
- Play the reface using recorded data from a DAW application
- Play a software synthesizer from the reface

This section explains how to connect the devices and make the necessary settings. The illustrations show the reface CS but apply to all models.

Connecting to a MIDI Device

■ Playing the reface from a MIDI keyboard

- ① Connect the MIDI OUT terminal on the MIDI keyboard to the reface's MIDI IN terminal.

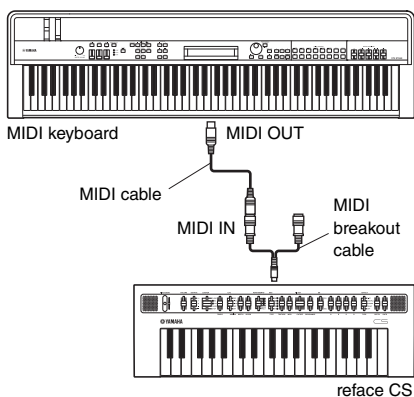

- ② Play the MIDI keyboard and confirm that the reface produces sound in response.

■ Playing a tone generator module by using the reface

- ① Turn off Local Control, and also turn off MIDI Control. For details, refer to “Keyboard Settings” (page 41).

To play a tone generator module from the reface, the transmit channel on the reface and the receive channel on the tone generator module must be the same. By default, the reface's transmit channel is set to “1.” On the reface DX only, the transmit channel can be changed (by using the [FUNCTION] button). For details on how to change the receive channel on the tone generator module, refer to the owner's manual that came with it.

- ② Connect the reface's MIDI OUT terminal to the tone generator module's MIDI IN terminal.

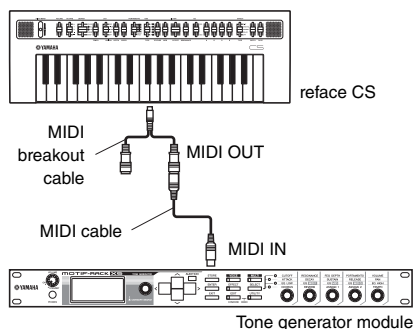

- ③ Play the reface and confirm that the tone generator module produces sound in response.

■ Connecting a reface CS and reface DX and synchronizing their Phrase Loopers

With, for example, a reface CS and a reface DX connected via a MIDI cable, operations performed by using the Phrase Looper on the reface CS will cause the Phrase Looper on the reface DX to play simultaneously.

- ① Set the transmit channel on the reface you will operate (in this example, the reface CS) to “off.” For details, refer to “Keyboard Settings” (page 41).
- ② Create a phrase loop on each of the reface CS and the reface DX.
- ③ Connect the MIDI OUT terminal of the reface you will operate (in this example, the reface CS) and the MIDI IN terminal on the reface you want to produce sound simultaneously (in this example, the reface DX).

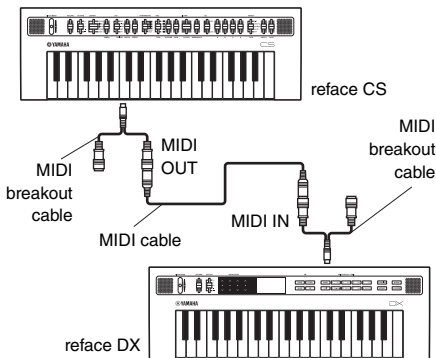

- ④ Switch the Phrase Looper on the reface CS to “PLAY” to also start simultaneous playback of the Phrase Looper on the reface DX at the same tempo. Using both of the Phrase Loopers together makes it possible to create even more complex loop phrases.

■ Connecting a Computer

■ Recording performances on the reface as MIDI data in a DAW application

- ① Turn off Local Control, and turn on MIDI Control. For details, refer to “Keyboard Settings” (page 41).
- ② Connect your reface to the computer by using a USB cable.

NOTE

- Be sure to read “Precautions when Using the [USB] Terminal” (page 39) before using the [USB] terminal.
- If your computer does not recognize the reface or you experience other similar problems, refer to “Yamaha USB-MIDI Driver” (page 39).

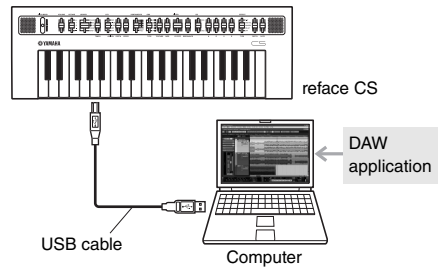

- ③ Start recording in the DAW application and play the reface.

■ Playing the reface using recorded data from a DAW application

- ① Turn on MIDI Control. For details, refer to “Keyboard Settings” (page 41).
- ② Connect the computer to your reface by using a USB cable.

NOTE

- Be sure to read “Precautions when Using the [USB] Terminal” (page 39) before using the [USB] terminal.
- If your computer does not recognize the reface or you experience other similar problems, refer to “Yamaha USB-MIDI Driver” (page 39).

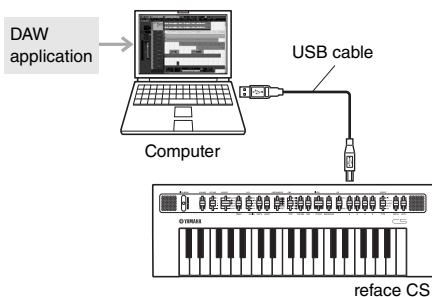

- ③ Start playback of the MIDI data in the DAW application.

■ Playing a software synthesizer from the reface

- ① Turn off Local Control, and also turn off MIDI Control. For details, refer to “Keyboard Settings” (page 41).
- ② Connect your reface to the computer by using a USB cable.

NOTE

- Be sure to read “Precautions when Using the [USB] Terminal” (page 39) before using the [USB] terminal.
- If your computer does not recognize the reface or you experience other similar problems, refer to “Yamaha USB-MIDI Driver” (page 39).

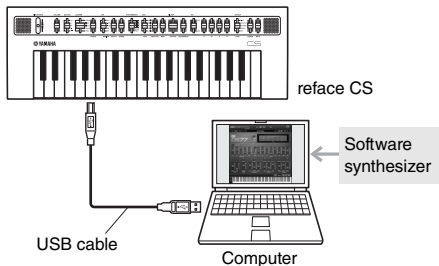

- ③ Launch the software synthesizer on the computer and play your reface’s keyboard.

NOTE

If using a software synthesizer inside a DAW application:

By using a function known as echo back or MIDI thru, DAW applications can send received performance data back to the source—in this case, the reface. This function must be disabled if you do not want the reface to produce sounds in response to returned MIDI data. For details on how to do this, refer to the owner’s manual that came with your DAW application.

Precautions when Using the [USB] Terminal

When connecting this instrument to a computer via the [USB] terminal, be sure to observe the following precautions. Failing to do so risks freezing your computer or instrument and corrupting or losing data.

If your computer or instrument should freeze, try restarting the application being used, rebooting the computer, and turning the instrument off and then back on.

NOTICE

- Use a USB A-B cable of no more than 3 meters in length. Do not use a USB 3.0 cable.
- Before connecting to your computer via the [USB] terminal, disable any power-saving mode (such as Suspend, Sleep, or Standby).
- Connect your computer via the [USB] terminal before turning on the instrument.
- Be sure to always perform the following steps before turning the instrument on or off (standby) and either plugging in or unplugging a USB cable.
 - Quit all applications.
 - Ensure that no data is being transmitted from the instrument. (Note that even playing a single key causes data to be transmitted.)
- When connected to a computer, allow at least six seconds to pass between turning the instrument on and off and plugging in and unplugging the USB cable.

Yamaha USB-MIDI Driver

Normally, the transmission and receipt of data begins automatically after connecting MIDI cables and turning on the instrument. If, however, your computer is having difficulty communicating with the instrument, please download the standard Yamaha USB-MIDI driver from the following web page and install it on your computer.

<http://download.yamaha.com/>

NOTE

- Information on system requirements can also be found on the above web page.
- The USB-MIDI driver may be revised and updated without prior notice. Before installing, visit the above web page to confirm the latest related information and ensure that you have the most up-to-date version.

Connecting an iPhone or iPad

NOTE

In order to eliminate the risk of noise from other communication when using this instrument with an iPad or iPhone app, be sure to turn on Airplane Mode and then turn on Wi-Fi.

NOTICE

Be sure to place your iPad or iPhone on a stable surface to prevent it from falling over and being damaged.

Apps compatible with the reface provide many more convenient, enjoyable ways to use this musical instrument.

For details on how to connect the devices, refer to the “iPhone/iPad Connection Manual,” which is available from the Yamaha web site.

Details of compatible smart devices and apps can be found on the following page from the Yamaha web site.

<http://www.yamaha.com/kbdapps/>

Restoring the Factory Default Settings (Factory Reset)

When you do a Factory Reset, all parameters will be returned to their factory default settings.

NOTICE

- **reface DX only:**

All settings stored on the instrument by using the [FUNCTION] button will be overwritten with their factory defaults when you do a Factory Reset.

Using the Factory Reset Function

① While holding down the rightmost key on the keyboard, turn on the instrument.

- **reface CS, reface CP, and reface YC**

The instrument's lamps will flash.

- **reface DX**

The message "Factory reset" will be displayed on-screen.

When the Factory Reset has finished, the lamps will stop flashing or the message will disappear.

② When the lamps stop flashing or the message is no longer displayed, remove your finger from the keyboard.

- **reface DX:**

You can also use the [FUNCTION] button to do a Factory Reset.

① Select the Job screen by pressing the [FUNCTION] button.

② Tap the "FACTRY RESET" switch.
A confirmation message will be displayed on-screen.

③ Tap the "YES" switch.
All parameters will be returned to their factory default settings.

Appendix

■ Keyboard Settings

To make the keyboard settings described below, hold down the corresponding key on the keyboard and press the [⏻] (Standby/On) switch. If the instrument is turned on, you will need to turn it off once to make settings in this way.

Each setting is toggled on and off, etc. whenever this procedure is carried out. However, when you have set the Auto Power-Off function to off (disabled), you will need to do a Factory Reset to turn in back on (enabled).

Keyboard settings are retained when the instrument is turned off.

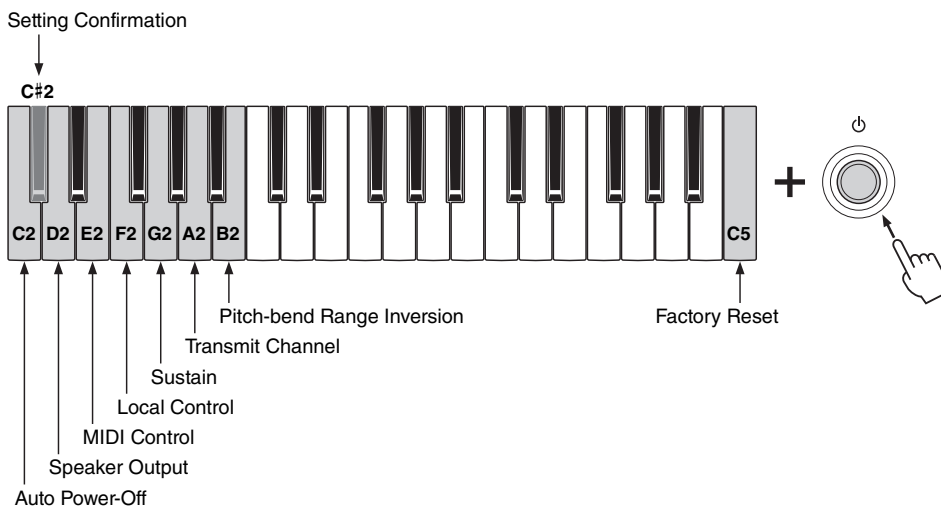

On the reface DX, these settings can also be made by using the [FUNCTION] button. For details, refer to “Functions of Front Panel Components” for the reface DX (page 16).

● Auto Power-Off

ON (enabled): To conserve power, the instrument will turn off automatically after 30 minutes of inactivity.

off (disabled): The instrument will not turn off automatically.

For details, refer to “Auto Power-Off” (page 8).

Factory default setting: ON (enabled)

● Display when turned off (disabled)

CS	The lamps from the LOOPER section flash.
DX	“Auto power off disabled” is displayed on-screen.
CP	The [TYPE] knob’s Clv lamp and the lamps from the TREMOLO/WAH to D.DELAY/A.DELAY sections flash.
YC	The ROTARY SPEED lamps flash.

● Factory Reset

For returning all settings, including keyboard settings, to their factory defaults. On the reface CS and the reface DX, loop phrases are also restored to the factory default condition.

For details, refer to “Restoring the Factory Default Settings (Factory Reset)” (page 40).

● Display when carried out

CS	The OSC [TYPE] lamps flash.
DX	“Factory reset” is displayed on-screen.
CP	The TYPE lamps flash.
YC	The WAVE lamps flash.

● Speaker Output

For setting whether or not to output the instrument’s sound from its built-in speakers. The speakers will not produce any sound when this parameter is set to “off.”

Factory default setting: ON

● Display when set

CS	ON: The lamps from the LOOPER section light up. off: The lamps from the LOOPER section flash.
DX	“speakers ON” or “speakers off” is displayed on-screen.
CP	ON: The [TYPE] knob’s Clv lamp and the lamps from the TREMOLO/WAH to D.DELAY/ A.DELAY sections light up. off: The [TYPE] knob’s Clv lamp and the lamps from the TREMOLO/WAH to D.DELAY/ A.DELAY sections flash.
YC	ON: The ROTARY SPEED lamps light up. off: The ROTARY SPEED lamps flash.

● MIDI Control

For turning on and off the transmission and receipt of MIDI Control Change messages specifically for the reface. When you operate the instrument with this parameter turned on, MIDI messages for your specific model will be transmitted. No messages are transmitted when you change the volume or octave. On the reface DX, a MIDI Control Change message is transmitted when a setting is changed in the FM section ([FREQ], [LEVEL], [ALGO], and [FB] buttons) but not when any other settings are changed. For more information about the correspondence between controllers, control change numbers, and values, refer to the MIDI Reference (a digital manual).

Factory default setting: off

● Display when set

CS	ON: The lamps from the LOOPER section light up. off: The lamps from the LOOPER section flash.
DX	“MIDI control ON” or “MIDI control off” is displayed on-screen.
CP	ON: The [TYPE] knob’s Clv lamp and the lamps from the TREMOLO/WAH to D.DELAY/ A.DELAY sections light up. off: The [TYPE] knob’s Clv lamp and the lamps from the TREMOLO/WAH to D.DELAY/ A.DELAY sections flash.
YC	ON: The ROTARY SPEED lamps light up. off: The ROTARY SPEED lamps flash.

● Local Control

For setting whether to internally disconnect (“off”) or connect (“ON”) the instrument’s internal tone generator and keyboard. If you wish to control your reface’s internal tone generator by using an external MIDI controller but not its keyboard, set MIDI Control to “ON” and Local Control to “off.”

Factory default setting: ON

● Display when set

CS	ON: The lamps from the LOOPER section light up. off: The lamps from the LOOPER section flash.
DX	“Local control ON” or “Local control off” is displayed on-screen.
CP	ON: The [TYPE] knob’s Clv lamp and the lamps from the TREMOLO/WAH to D.DELAY/A.DELAY sections light up. off: The [TYPE] knob’s Clv lamp and the lamps from the TREMOLO/WAH to D.DELAY/A.DELAY sections flash.
YC	ON: The ROTARY SPEED lamps light up. off: The ROTARY SPEED lamps flash.

● Sustain (reface DX and reface CP)

For switching the sustain setting. If you have connected a foot pedal (FC3) or a foot switch (FC4 or FC5) to the instrument, you will need to set either “FC3” or “FC4/5” depending on whether or not it supports half-damper operation.

Factory default settings:

DX: FC4/5 (an FC4 or FC5, or an FC3 without half-damper operation)

CP: FC3 (an FC3 with half-damper operation)

● Display when set

DX	“Sustain FC3” or “Sustain FC4/5” is displayed on-screen.
CP	FC3: The [TYPE] knob’s Clv lamp and the lamps from the TREMOLO/WAH to D.DELAY/A.DELAY sections light up. FC4/5: The [TYPE] knob’s Clv lamp and the lamps from the TREMOLO/WAH to D.DELAY/A.DELAY sections flash.

● Transmit Channel (reface CS and reface DX)

For setting the MIDI transmit channel. This parameter can be set to either “1 ch” (Channel 1) or “off.”

Factory default settings: 1 ch (Channel 1)

● Display when set

CS	1 ch: The lamps from the LOOPER section light up. off: The lamps from the LOOPER section flash.
DX	“MIDI transmit ch 1” or “MIDI transmit ch off” is displayed on-screen.

On the reface DX, channels 2 to 16 can also be selected on the MIDI Settings screen, which is displayed by using the [FUNCTION] button. For details, refer to “Functions of Front Panel Components” for the reface DX (page 16).

● Pitch-bend Range Inversion (CS only)

By changing the direction in which note pitches are changed by the [PITCH BEND] lever, you can produce guitar-like note bending effects when playing the reface CS as a keytar.

Factory default settings: +12 (the pitch rises when you move the lever up)

● Display when set

CS	+12: The lamps from the LOOPER section light up. -12: The lamps from the LOOPER section flash.
-----------	---

● Setting Confirmation

For confirming the current settings of all parameters set by the keyboard.

● Display when confirming

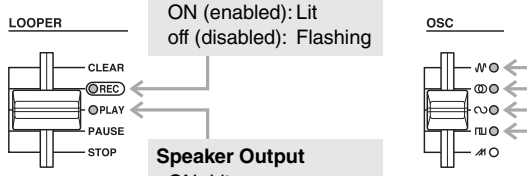
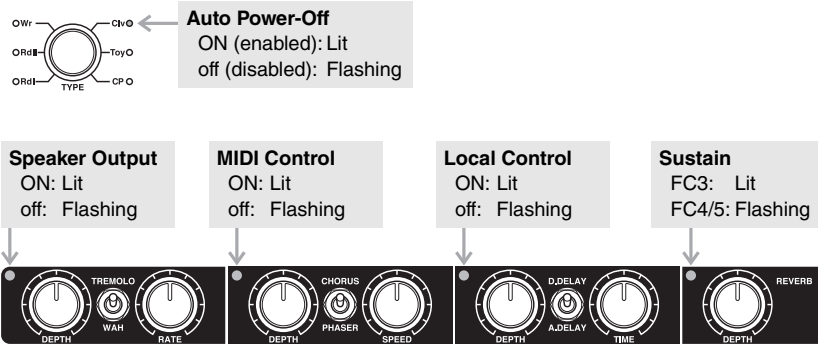
CS	 <div style="display: flex; justify-content: space-around; margin-top: 10px;"> <div style="border: 1px solid gray; padding: 5px; background-color: #f0f0f0;"> <p>Auto Power-Off ON (enabled): Lit off (disabled): Flashing</p> </div> <div style="border: 1px solid gray; padding: 5px; background-color: #f0f0f0;"> <p>Speaker Output ON: Lit off: Flashing</p> </div> </div> <div style="display: flex; justify-content: space-around; margin-top: 10px;"> <div style="border: 1px solid gray; padding: 5px; background-color: #f0f0f0;"> <p>MIDI Control ON: Lit off: Flashing</p> </div> <div style="border: 1px solid gray; padding: 5px; background-color: #f0f0f0;"> <p>Local Control ON: Lit off: Flashing</p> </div> <div style="border: 1px solid gray; padding: 5px; background-color: #f0f0f0;"> <p>Transmit Channel 1ch: Lit off: Flashing</p> </div> <div style="border: 1px solid gray; padding: 5px; background-color: #f0f0f0;"> <p>Pitch-bend Range Inversion +12: Lit -12: Flashing</p> </div> </div>
DX	Presented on-screen
CP	 <div style="display: flex; justify-content: space-around; margin-top: 10px;"> <div style="border: 1px solid gray; padding: 5px; background-color: #f0f0f0;"> <p>Auto Power-Off ON (enabled): Lit off (disabled): Flashing</p> </div> <div style="border: 1px solid gray; padding: 5px; background-color: #f0f0f0;"> <p>Speaker Output ON: Lit off: Flashing</p> </div> <div style="border: 1px solid gray; padding: 5px; background-color: #f0f0f0;"> <p>MIDI Control ON: Lit off: Flashing</p> </div> <div style="border: 1px solid gray; padding: 5px; background-color: #f0f0f0;"> <p>Local Control ON: Lit off: Flashing</p> </div> <div style="border: 1px solid gray; padding: 5px; background-color: #f0f0f0;"> <p>Sustain FC3: Lit FC4/5: Flashing</p> </div> </div>

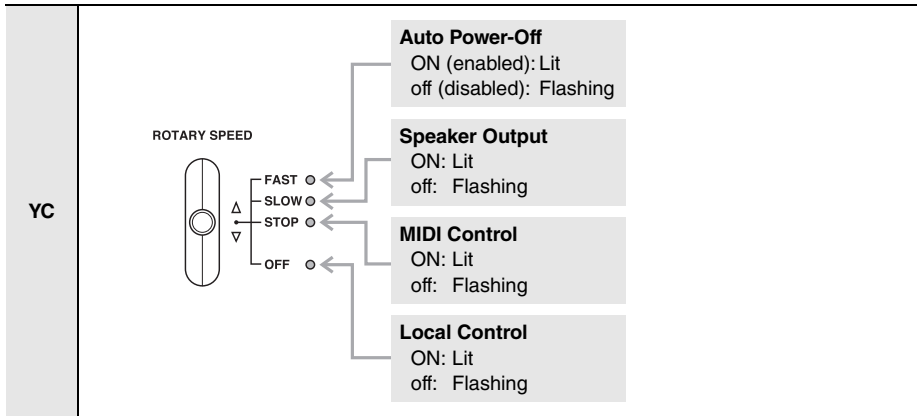

■ reface DX Messages

Message	Description
Are you sure?	Confirms whether or not you wish to proceed with the selected operation.
Battery Low!	Indicates that the battery voltage has dropped. Either replace the batteries or correctly connect the AC adaptor.
Looper Memory Full	Indicates that the memory allocated to the Phrase Looper is full, preventing recorded data from being stored.
Stopping Looper, OK?	Indicates that playback or recording with the Phrase Looper must be stopped before performing an operation.

■ Troubleshooting

If this instrument does not behave as expected—for example, not producing the correct sound or producing no sound at all—please try to resolve the issue as described below. Many issues can also be resolved by doing a Factory Reset (page 40). If any specific issue should persist, please contact your Yamaha dealer or a service center (see the back of this booklet).

Issue		Model(s)	Suspected cause	Solution
The instrument turns off unexpectedly.		All	This is normal when the Auto Power-Off function is enabled.	If necessary, you can deactivate the Auto Power-Off function to prevent it turning off the instrument again. (Page 41)
No sound is produced.	No sound is produced by the built-in speakers.	All	The volume is turned fully down.	Raise the volume by using the [VOLUME] or [VOL] slider.
			Headphones are connected.	Unplug the headphones. (Page 5)
			Local Control is turned off.	Turn on Local Control. (Page 43)
			Speaker Output is turned off.	Turn on Speaker Output. (Page 42)
		CS YC	MIDI volume or expression has been set to a very low level by a foot controller.	If a foot controller has been connected to the [FOOT CONTROLLER] jack, try using it to increase the volume.
	Sound input via the [AUX IN] jack cannot be heard.	All	The volume on the connected audio equipment has been turned fully down.	Raise the volume on the connected audio equipment.
	The instrument stopped producing sound when a setting was changed.	CS	The Attack (A) setting from the EG section is too high.	Lower the [A] slider.
		CS	The filter's cutoff frequency is too low.	Adjust the filter's cutoff frequency.
		CS DX	Amplitude (AMP) is being modulated by the LFO, the LFO's depth is high, and its speed is low.	Change the LFO assignment, reduce the depth, or increase the speed.
		DX	The carrier level is set to 0.	Increase the carrier level.
DX		All carriers are turned off.	Turn a carrier on and ensure that its level is sufficiently high.	
DX		The FREQ or RATIO setting for a carrier (or multiple carriers) is too high.	Decrease the FREQ or RATIO setting.	
	YC	All of the FOOTAGE sliders are fully up. In this condition, the volume is 0.	Lower some of the FOOTAGE sliders.	

Issue	Model(s)	Suspected cause	Solution	
Certain sounds are not produced. Sound output is intermittent and stuttered.	CS DX	The maximum number of sounds that can be produced by the Phrase Looper has been exceeded.	Use the instrument in such a way that the maximum number of simultaneous sounds is not exceeded.	
	CS DX	The playing mode has been set to "MONO."	Switch the playing mode from "MONO" to "POLY" to play multiple notes at the same time.	
	Low notes are not produced.	YC	Only the [16'] FOOTAGE slider is lowered, and the [OCTAVE] slider is also lowered. In this condition, notes are too low to be produced.	Raise the [OCTAVE] slider.
	The instrument stopped producing organ sounds. (Only percussion can be heard.)	YC	With the H-type organ, lowering the [1'] FOOTAGE slider does not cause organ sounds to be produced. Instead, it produces only percussion sounds.	This is normal.
Sounds continue without end.	CS	The Release (R) setting from the EG section is too high.	Lower the [R] slider from the EG section.	
	CS DX	The delay's depth is set too high.	Lower the delay depth.	
	CS DX	The Phrase Looper is playing a loop phrase.	Pause or stop the Phrase Looper.	
	CP	The depth for D.DELAY or A.DELAY is set too high.	Lower the D.DELAY or A.DELAY depth.	
Sounds are distorted.	All	Parameters used to distort the sound have been set.	On the reface CS, change the OSC, resonance, or distortion effect settings; on the reface DX, change modulator values or distortion effect settings; on the reface CP, change the [DRIVE] knob setting; on the reface YC, change the DIST setting.	
A pedal has no effect.	All	The pedal is not correctly connected.	Ensure that the pedal's cord is fully plugged into the [FOOT CONTROLLER] or [SUSTAIN] jack.	

■ Specifications

Item		Details			
		reface CS	reface DX	reface CP	reface YC
Keyboard	Number of Keys	37 keys			
	Type	HQ (High Quality) Mini Keys			
	Initial Touch	Yes			
Tone Generation	Tone Generation Technology	AN (Analog Physical Modeling)	FM	SCM (Spectral Component Modeling) + AWM2	AWM (Organ Flutes)
	Number of Polyphony (Max.)	8	8	128	128
Voices	Number of Types	5	12 (Algorithms)	6	5
	Number of Voices	—	32	—	—
	Effects	Distortion, Chorus/Flanger, Phaser, Delay	Distortion, Touch Wah, Chorus, Flanger, Phaser, Delay, Reverb	Drive, Tremolo, Wah, Chorus, Phaser, Digital Delay, Analog-Type Delay, Reverb	Rotary Speaker, Distortion, Reverb
Phrase Looper		Yes	Yes	—	—
Display	Type	—	Full Dot LCD (128 x 64 dots)	—	—
Connectivity	DC IN	DC IN (12 V) jack			
	Headphones	PHONES (6.3 mm, stereo phone jack)			
	OUTPUT	OUTPUT L/MONO, R (6.3 mm, TS phone jack, unbalanced)			
	Pedal	FOOT CONTROLLER	SUSTAIN	SUSTAIN	FOOT CONTROLLER
	AUX IN	AUX IN (3.5 mm, mini stereo phone jack)			
	USB TO HOST	USB (TO HOST)			
	MIDI	MIDI (mini-DIN IN/OUT)			
Amplifiers/ Speakers	Amplifiers	2 W x 2			
	Speakers	3 cm x 2			
Power Supply	Power Supply	PA-130 or an equivalent recommended by Yamaha			
	Batteries	Six "AA" size batteries or Ni-MH rechargeable batteries			
	Power Consumption	6W (When using PA-130 power adaptor)			
	Auto Power Off	Yes			
Size/ Weight	Dimensions (W x D x H)	530 (W) x 175 (D) x 60 (H) mm (20 7/8" x 6 7/8" x 2 3/8")			
	Weight	1.9 kg (4 lbs, 3 oz) (not including batteries)			
Included Accessories		AC adaptor*, MIDI breakout cable, Owner's Manual, Warranty* *May be included depending on your locale			

* The contents of this manual apply to the latest specifications as of the printing date.

Since Yamaha makes continuous improvements to the product, this manual may not apply to the specifications of your particular product. To obtain the latest manual, access the Yamaha website then download the manual file. Since specifications, equipment or separately sold accessories may not be the same in every locale, please check with your Yamaha dealer.

■ Index

Numerics

[1]–[8] buttons 20

A

AC Adaptor 6
 [A][D][S][R] sliders 13
 [ALGO] (Algorithm) button 19
 [ASSIGN] slider 11
 Auto Power-Off 8, 22, 41
 [AUX IN] jack 5

B

[BANK] button 20
 Batteries 7
 Built-in speakers 10, 16, 26, 32

C

carrier 18
 CHORUS/PHASER 28
 [CHORUS/PHASER] switch 28
 Computer 37
 CONTRAST 22
 [CUTOFF] slider 13

D

DATA ENTRY section 16
 DAW application 37, 38
 DC IN jack 4
 D. DELAY/A. DELAY
 (Digital Delay Analog Delay) . 29
 [D.DELAY/A.DELAY] switch 29
 [DEPTH] knob 28, 29
 [DEPTH] slider 11, 13, 34
 Display 18
 [DIST] slider 34
 [DRIVE] knob 27

E

[EDIT] button 20
 Edit Recall 22
 [EFFECT] button 22
 EFFECT section 13, 34
 EG Balance slider 13
 [EG level] button 20
 [EG rate] button 20
 EG section 13

F

Factory Reset 22, 40, 42
 [FB] (Feedback) button 19
 FILTER section 13
 Flick 17
 FM section 18
 FM tone generator 18
 [FOOT CONTROLLER] jack 4
 FOOTAGE section 33
 [FREQ] (frequency) button 19
 [FUNCTION] button 21

I

iPhone/iPad 39

J

Job screen 22

L

[LENGTH] slider 34
 [LEVEL] button 19
 [LFO] button 20
 LFO section 11
 Local Control 21, 43
 [LOOPER] button 23
 LOOPER section 10
 LOOPER slider 11

M

MIDI control 21, 42
 MIDI keyboard 36
 MIDI receive channel 21
 MIDI Settings screen 21
 [MIDI] terminal 5
 MIDI transmit channel 21
 [MOD] (Modulation) slider 12
 modulator 18
 MONO/POLY 21

O

[OCT] (Octave) slider 26
 [OCTAVE] slider 10, 16, 32
 [ON/OFF] switch 34
 [OP1]–[OP4] buttons 20
 operators 18
 OSC (Oscillator) section 12
 Other Devices 36
 OUTPUT [R]/[L/MONO] jacks 5
 overdub 15, 25

P

PERCUSSION section 34
 [PHONES] jack 5
 Phrase Looper 14, 24
 [PITCH BEND] lever 10, 16
 Pitch Bend Range 21
 [Pitch EG] button 20
 Pitch-bend Range Inversion 44
 [PORTAMENTO] slider 11
 Portamento Time 21

R

[RATE] knob 28
 [RATE] slider 13
 Rear Panel 4
 [RESONANCE] slider 13
 REVERB section 29
 [REVERB] slider 34
 [ROTARY SPEED] lever 32

S

Setting Confirmation 44
 software synthesizer 38
 Speaker Output 22, 42
 [SPEED] knob 29
 [SPEED] slider 11
 [⏻] (Standby/On) switch 4
 [STORE] button 23
 Store Name screen 23
 Store screen 23
 Sustain 22, 43
 [SUSTAIN] jack 4
 switches 16
 synchronizing 37
 System Settings screen 22

T

Tap 17
 [TEMPO] slider 11
 [TEXTURE] slider 12
 [TIME] knob 29
 tone generator module 36
 Touch-type sliders 16
 Transmit Channel 43
 Transpose 21
 TREMOLO/WAH 27
 [TREMOLO/WAH] switch 28
 Turning On and Off 6, 8
 [TYPE] knob 26
 [TYPE] slider 12, 13
 [TYPE] switch 34

U

[USB] terminal 5, 39

V

VIBRATO/CHORUS section 34
 [VIBRATO/CHORUS] switch 34
 Voice Initialize 22
 Voice Parameter
 Settings screen 21
 VOICE RECALL 22
 VOICE SELECT/EDIT section 20
 [VOL] (Volume) slider 26
 [VOLUME] slider 10, 16, 32

W

[WAVE] knob 33

Y

Yamaha USB-MIDI Driver 39

OBSERVERA!

Apparaten kopplas inte ur växelströmskällan (nätet) så länge som den är ansluten till vägguttaget, även om själva apparaten har stängts av.

ADVARSSEL: Netspændingen til dette apparat er IKKE afbrudt, så længe netledningen sidder i en stikkontakt, som er tændt — også selvom der er slukket på apparatets afbryder.

VAROITUS: Laitteen toisiopiiriin kytketty käyttökytkin ei irroita koko laitetta verkosta.

(standby)

Information for Users on Collection and Disposal of Old Equipment and used Batteries



These symbols on the products, packaging, and/or accompanying documents mean that used electrical and electronic products and batteries should not be mixed with general household waste.

For proper treatment, recovery and recycling of old products and used batteries, please take them to applicable collection points, in accordance with your national legislation and the Directives 2002/96/EC and 2006/66/EC.



By disposing of these products and batteries correctly, you will help to save valuable resources and prevent any potential negative effects on human health and the environment which could otherwise arise from inappropriate waste handling.

For more information about collection and recycling of old products and batteries, please contact your local municipality, your waste disposal service or the point of sale where you purchased the items.



[For business users in the European Union]

If you wish to discard electrical and electronic equipment, please contact your dealer or supplier for further information.



[Information on Disposal in other Countries outside the European Union]

These symbols are only valid in the European Union. If you wish to discard these items, please contact your local authorities or dealer and ask for the correct method of disposal.

Cd

Note for the battery symbol (bottom two symbol examples):

This symbol might be used in combination with a chemical symbol. In this case it complies with the requirement set by the Directive for the chemical involved.

(weee_battery_eu_en_01)

Entsorgung leerer Batterien (nur innerhalb Deutschlands)

Leisten Sie einen Beitrag zum Umweltschutz. Verbrauchte Batterien oder Akkumulatoren dürfen nicht in den Hausmüll. Sie können bei einer Sammelstelle für Altbatterien bzw. Sondermüll abgegeben werden. Informieren Sie sich bei Ihrer Kommune.

(battery)

Important Notice: Guarantee Information for customers in European Economic Area (EEA) and Switzerland

<p>Important Notice: Guarantee Information for customers in EEA* and Switzerland</p> <p>For detailed guarantee information about this Yamaha product, and Pan-EEA* and Switzerland warranty service, please either visit the website address below (Printable file is available at our website) or contact the Yamaha representative office for your country. * EEA: European Economic Area</p>	English
<p>Wichtiger Hinweis: Garantie-Information für Kunden in der EWR* und der Schweiz</p> <p>Für nähere Garantie-Information über dieses Produkt von Yamaha, sowie über den Pan-EWR*- und Schweizer Garantieservice, besuchen Sie bitte entweder die folgend angegebene Internetadresse (eine druckfähige Version befindet sich auch auf unserer Webseite), oder wenden Sie sich an den für Ihr Land zuständigen Yamaha-Vertrieb. *EWR: Europäischer Wirtschaftsraum</p>	Deutsch
<p>Remarque importante: informations de garantie pour les clients de l'EEE et la Suisse</p> <p>Pour des informations plus détaillées sur la garantie de ce produit Yamaha et sur le service de garantie applicable dans l'ensemble de l'EEE ainsi qu'en Suisse, consultez notre site Web à l'adresse ci-dessous (le fichier imprimable est disponible sur notre site Web) ou contactez directement Yamaha dans votre pays de résidence. * EEE : Espace Economique Européen</p>	Français
<p>Belangrijke mededeling: Garantie-informatie voor klanten in de EER* en Zwitserland</p> <p>Voor gedetailleerde garantie-informatie over dit Yamaha-product en de garantieservice in heel de EER* en Zwitserland, gaat u naar de onderstaande website (u vindt een afdrukbaar bestand op onze website) of neemt u contact op met de vertegenwoordiging van Yamaha in uw land. * EER: Europese Economische Ruimte</p>	Nederlands
<p>Aviso importante: información sobre la garantía para los clientes del EEE* y Suiza</p> <p>Para una información detallada sobre este producto Yamaha y sobre el soporte de garantía en la zona EEE* y Suiza, visite la dirección web que se incluye más abajo (la versión del archivo para imprimir está disponible en nuestro sitio web) o póngase en contacto con el representante de Yamaha en su país. * EEE: Espacio Económico Europeo</p>	Español
<p>Avviso importante: informazioni sulla garanzia per i clienti residenti nell'EEA* e in Svizzera</p> <p>Per informazioni dettagliate sulla garanzia relativa a questo prodotto Yamaha e l'assistenza in garanzia nei paesi EEA* e in Svizzera, potete consultare il sito Web all'indirizzo riportato di seguito (è disponibile il file in formato stampabile) oppure contattare l'ufficio di rappresentanza locale della Yamaha. * EEA: Area Economica Europea</p>	Italiano
<p>Aviso importante: informações sobre as garantias para clientes da AEE* e da Suíça</p> <p>Para obter uma informação pormenorizada sobre este produto da Yamaha e sobre o serviço de garantia na AEE* e na Suíça, visite o site a seguir (o arquivo para impressão está disponível no nosso site) ou entre em contato com o escritório de representação da Yamaha no seu país. * AEE: Área Económica Europeia</p>	Português
<p>Ἐπισημαντικὴ σημείωση: Πληροφορίες ἐγγύησης γιὰ τοὺς πελάτες ἐντὸς ΕΟΧ* καὶ Ἑλλάδας</p> <p>Γιὰ λεπτομερῆς πληροφορίες ἐγγύησης σχετικὰ μετὰ τὸ προϊόν τῆς Yamaha καὶ τὴν κάλυψη ἐγγύησης σὲ ὅλες τὶς χώρες τοῦ ΕΟΧ καὶ τὴν Ἑλλάδα, ἐπισκεφθεῖτε τὴν παρακάτω ἠλεκτρονικὴ (Ἐκτυπώσιμη μορφή είναι διαθέσιμη στὴν ἠλεκτρονικὴ μας) ἠθεύθυνση στὴν ἀντιστοιχία τῆς Yamaha στὴ χώρα σας. * ΕΟΧ: Ευρωπαϊκός Οικονομικός Χώρος</p>	Ελληνικά
<p>Viktigt: Garantiinformation för kunder i EES-området* och Schweiz</p> <p>För detaljerad information om denna Yamahaprodukt samt garantiservice i hela EES-området* och Schweiz kan du antingen besöka nedanstående webbadress (en utskriftsvänlig fil finns på webbplatsen) eller kontakta Yamahas officiella representant i ditt land. * EES: Europeiska Ekonomiska Samarbetsområdet</p>	Svenska
<p>Viktig merknad: Garantiinformasjon for kunder i EØS* og Sveits</p> <p>Detaljert garantiinformasjon om dette Yamaha-produktet og garantiservice for hele EØS-området* og Sveits kan fås enten ved å besøke nettadressen nedenfor (utskriftsversjon finnes på våre nettsider) eller kontakte kontaktpunktet i landet der du bor. *EØS: Det europeiske økonomiske samarbeidsområdet</p>	Norsk
<p>Vigtig oplysning: Garantioplysninger til kunder i EØ* og Schweiz</p> <p>De kan finde detaljerede garantioplysninger om dette Yamaha-produkt og de fælles garantiserviceordning for EØ* (og Schweiz) ved at besøge det websted, der er angivet nedenfor (der findes en fil, som kan udskrives, på vores websted), eller ved at kontakte Yamahas nationale repræsentationskontor i det land, hvor De bor. * EØ: Det Europæiske Økonomiske Område</p>	Dansk
<p>Tärkeä ilmoitus: Taku tiedot Euroopan talousalueen (ETA)* ja Sveitsin asiakkaille</p> <p>Tämän Yamaha-tuotteen sekä ETA-alueen ja Sveitsin takuuta koskevat yksityiskohtaiset tiedot saatte alla olevasta nettiosoitteesta. (Tulostettava tiedosto saatavissa sivustollamme.) Voitte myös ottaa yhteyttä paikalliseen Yamaha-edustajaan. *ETA: Euroopan talousalue</p>	Suomi
<p>Ważne: Warunki gwarancyjne obowiązujące w EOG* i Szwajcarii</p> <p>Aby dowiedzieć się więcej na temat warunków gwarancyjnych tego produktu firmy Yamaha i serwisu gwarancyjnego w całym EOG* i Szwajcarii, należy odwiedzić wskazaną poniżej stronę internetową (Plik gotowy do wydruku znajduje się na naszej stronie internetowej) lub skontaktować się z przedstawicielem firmy Yamaha w swoim kraju. * EOG — Europejski Obszar Gospodarczy</p>	Polski
<p>Důležité oznámení: Záruční informace pro zákazníky v EHS* a ve Švýcarsku</p> <p>Podrobné záruční informace o tomto produktu Yamaha a záručním servisu v celém EHS* a ve Švýcarsku naleznete na níže uvedeném webovém adresě (soubor k tisku je dostupný na našich webových stránkách) nebo se můžete obrátit na zastupující firmy Yamaha ve své zemi. * EHS: Evropský hospodářský prostor</p>	Česky
<p>Fontos figyelemzetés: Garancia-információk az EGT* területén és Svájcban élő vásárlók számára</p> <p>A jelen Yamaha termékre vonatkozó részletes garancia-információk, valamint az EGT*-re és Svájcra kiterjedő garanciális szolgáltatás tekintetében keressék fel webhelyünket az alábbi címen (a webhelyen nyomtatható fájl is található), vagy pedig lépjen kapcsolatba az országában működő Yamaha képviselői iróddal. * EGT: Európai Gazdasági Térség</p>	Magyar
<p>Outline märkus: Garantiteave Euroopa Majanduspiirkonna (EMP)* ja Šveitsi klientidele</p> <p>Täpsemate teabe saamiseks selle Yamaha toote garanteeringu kohta Euroopa Majanduspiirkonnas ja Šveitsi garanteeringu kohta, külastage palun veebisaiti alljärgneval aadressil (meie saitil on saadaval printitav fail) või pöörduge Teie regiooni Yamaha esinduse poole. * EMP: Euroopa Majanduspiirkond</p>	Eesti keel
<p>Svarīgās paziņojums: garantijas informācija klientiem EEZ* un Šveicā</p> <p>Lai saņemtu detalizētu garantijas informāciju par šo Yamaha produktu, kā arī garantijas apkalpošanu EEZ* un Šveicā, ielūdzam apmeklētiet zemāk norādīto tīmekļa vietnes adresi (tīmekļa vietnē ir pieejams drukājams fails) vai sazinieties ar jūsu valstī apkalpojošo Yamaha pārstāvniecību. * EEZ: Eiropas Ekonomikas zona</p>	Latviešu
<p>Děmesio: informacija dėl garantijos pirkėjams EEE* ir Šveicarijoje</p> <p>Jei reikia išsamios informacijos apie šį „Yamaha“ produktą ir jo techninę priežiūrą visoje EEE* ir Šveicarijoje, apsilankykite mūsų svetainėje toliau nurodytą adresu (svetainėje yra spausdinamas failas) arba kreipkitės į „Yamaha“ atstovą savo šalyje. * EEE — Europos ekonominė erdvė</p>	Lietuvių kalba
<p>Dôležité upozornenie: Informácie o záruke pre zákazníkov v EHP* a Švajčiarsku</p> <p>Podrobné informácie o záruke týkajúcej sa tohto produktu od spoločnosti Yamaha a garančnom servise v EHP* a Švajčiarsku nájdete na webovej stránke uvedenej nižšie (na našej webovej stránke je k dispozícii súbor na tlač) alebo sa obráťte na zástupcu spoločnosti Yamaha vo svojej krajine. * EHP: Európsky hospodársky priestor</p>	Slovenčina
<p>Pomembno obvestilo: Informacije o garanciji za kupce v EGP* in Švici</p> <p>Podrobne informacije o tem Yamahinem izdelku ter garancijskem servisu v celotnem EGP in Švici, obiščite spletno mesto, ki je navedeno spodaj (natifljiva datoteka je na voljo na našem spletnem mestu), ali se obrnite na Yamahinega predstavnika v svoji državi. * EGP: Evropski gospodarski prostor</p>	Slovensčina
<p>Важно съобщение: Информация за гаранцията за този продукт на Yamaha и гаранционното обслужване в паневропейската зона на ЕИП* и Швейцария</p> <p>За подробна информация за гаранцията за този продукт на Yamaha и гаранционното обслужване в паневропейската зона на ЕИП* и Швейцария или посетете посочения по-долу уеб сайт (на нашия уеб сайт има файл за печат), или се свържете с представителния офис на Yamaha във вашата страна. * ЕИП: Европейски икономическо пространство</p>	Български език
<p>Notificare importantă: Informații despre garanție pentru clienții din SEE* și Elveția</p> <p>Pentru informații detaliate privind acest produs Yamaha și serviciul de garanție Pan-SEE* și Elveția, vizitați site-ul la adresa de mai jos (fișierul imprimabil este disponibil pe site-ul nostru) sau contactați biroul reprezentanței Yamaha din țara dumneavoastră. * SEE: Spațiul Economic European</p>	Limba română

<http://europe.yamaha.com/warranty/>

URL_4

LIMITED WARRANTY ON

Music Production Products

Thank you for selecting a YAMAHA product. YAMAHA products are designed and manufactured to provide a high level of defect-free performance. Yamaha Corporation of America ("YAMAHA") is proud of the experience and craftsmanship that goes into each and every YAMAHA product. YAMAHA sells its products through a network of reputable, specially authorized dealers and is pleased to offer you, the Original Owner, the following Limited Warranty, which applies only to products that have been (1) directly purchased from YAMAHA's authorized dealers in the fifty states of the USA and District of Columbia (the "Warranted Area") and (2) used exclusively in the Warranted Area. YAMAHA suggests that you read the Limited Warranty thoroughly, and invites you to contact your authorized YAMAHA dealer or YAMAHA Customer Service if you have any questions.

THIS WARRANTY COVERS THE LISTED PRODUCTS AGAINST DEFECTS IN MATERIALS OR WORKMANSHIP FOR THE FOLLOWING PERIODS:

Warranty Term

Type of Product	Duration of Warranty from Date of Purchase by or for the Original Owner
SYNTHESIZERS	1 year
MOBILE MINI KEYBOARD	1 year
MONITOR SPEAKERS	1 year
AUDIO INTERFACES	1 year
MIDI CONTROLLERS	1 year
WIND MIDI CONTROLLERS	1 year
MUSIC PRODUCTION ACCESSORIES	1 year

Coverage: YAMAHA will, at its option, repair or replace the product covered by this warranty if it becomes defective, malfunctions or otherwise fails to conform with this warranty under normal use and service during the term of this warranty, without charge for labor or materials. Repairs may be performed using new or refurbished parts that meet or exceed YAMAHA specifications for new parts. If YAMAHA elects to replace the product, the replacement may be a reconditioned unit. You will be responsible for any installation or removal charges and for any initial shipping charges if the product(s) must be shipped for warranty service. However, YAMAHA will pay the return shipping charges to any destination within the USA if the repairs are covered by the warranty. This warranty does not cover (a) damage, deterioration or malfunction resulting from accident, negligence, misuse, abuse, improper installation or operation or failure to follow instructions according to the Owner's Manual for this product; any shipment of the product (claims must be presented to the carrier); repair or attempted repair by anyone other than YAMAHA or an authorized YAMAHA Service Center; (b) any unit which has been altered or on which the serial number has been defaced, modified or removed; (c) normal wear, and any periodic maintenance; (d) deterioration due to perspiration, corrosive atmosphere or other external causes such as extremes in temperature or humidity; (e) damages attributable to power line surge or related electrical abnormalities, lightning damage or acts of God; or (f) RFI/EMI (Interference/noise) caused by improper grounding or the improper use of either certified or uncertified equipment, if applicable. Any evidence of alteration, erasing or forgery of

proof-of-purchase documents will cause this warranty to be void. This warranty covers only the Original Owner and is not transferable.

In Order to Obtain Warranty Service: Warranty service will only be provided for defective products within the Warranted Area. Contact your local authorized YAMAHA dealer who will advise you of the procedures to be followed. If this is not successful, contact YAMAHA at the address, telephone number or website shown below. YAMAHA may request that you send the defective product to a local authorized YAMAHA Servicer or authorize return of the defective product to YAMAHA for repair. If you are uncertain as to whether a dealer has been authorized by YAMAHA, please contact YAMAHA's Service Department at the number shown below, or check Yamaha's website at <http://usa.yamaha.com>. Product(s) shipped for service should be packed securely and must be accompanied by a detailed explanation of the problem(s) requiring service, together with the original or a machine reproduction of the bill of sale or other dated, proof-of-purchase document describing the product, as evidence of warranty coverage. Should any product submitted for warranty service be found ineligible therefore, an estimate of repair cost will be furnished and the repair will be accomplished only if requested by you and upon receipt of payment or acceptable arrangement for payment.

Limitation of Implied Warranties and Exclusion of Damages:

ANY IMPLIED WARRANTIES, INCLUDING WARRANTIES OF MERCHANTABILITY AND FITNESS FOR A PARTICULAR PURPOSE SHALL BE LIMITED IN DURATION TO THE APPLICABLE PERIOD OF TIME SET FORTH ABOVE. YAMAHA SHALL NOT BE RESPONSIBLE FOR INCIDENTAL OR CONSEQUENTIAL DAMAGES OR FOR DAMAGES BASED UPON INCONVENIENCE, LOSS OF USE, DAMAGE TO ANY OTHER EQUIPMENT OR OTHER ITEMS AT THE SITE OF USE OR INTERRUPTION OF PERFORMANCES OR ANY CONSEQUENCES. YAMAHA'S LIABILITY FOR ANY DEFECTIVE PRODUCT IS LIMITED TO REPAIR OR REPLACEMENT OF THE PRODUCT, AT YAMAHA'S OPTION. SOME STATES DO NOT ALLOW LIMITATIONS ON HOW LONG AN IMPLIED WARRANTY LASTS OR THE EXCLUSION OR LIMITATION OF INCIDENTAL OR CONSEQUENTIAL DAMAGES, SO THE ABOVE LIMITATION OR EXCLUSION MAY NOT APPLY TO YOU. This Warranty gives you specific legal rights, and you may also have other rights which vary from state to state. This is the only express warranty applicable to the product specified herein; Yamaha neither assumes nor authorizes anyone to assume for it any other express warranty.

If you have any questions about service received or if you need assistance in locating an authorized YAMAHA Servicer, please contact:

Customer Service
Yamaha Corporation of America
6600 Orangethorpe Avenue, Buena Park, CA 90620-1373
Telephone: 800-854-1569 usa.yamaha.com



Do not return any product to the above address without a written Return Authorization issued by YAMAHA.

©2015 Yamaha Corporation of America.

For details of products, please contact your nearest Yamaha representative or the authorized distributor listed below.

Pour plus de détails sur les produits, veuillez-vous adresser à Yamaha ou au distributeur le plus proche de vous figurant dans la liste suivante.

Die Einzelheiten zu Produkten sind bei Ihrer unten aufgeführten Niederlassung und bei Yamaha Vertragshändlern in den jeweiligen Bestimmungsländern erhältlich.

Para detalles sobre productos, contacte su tienda Yamaha más cercana o el distribuidor autorizado que se lista debajo.

NORTH AMERICA

CANADA

Yamaha Canada Music Ltd.
135 Milner Avenue, Toronto, Ontario,
M1S 3R1, Canada
Tel: 416-298-1311

U.S.A.

Yamaha Corporation of America
6600 Orangehorpe Avenue, Buena Park, CA
90620, U.S.A.
Tel: 714-522-9011

CENTRAL & SOUTH AMERICA

MEXICO

Yamaha de México, S.A. de C.V.
Av. Insurgentes Sur 1647 "Prisma Insurgentes",
Col. San Jose Insurgentes, Del. Benito Juarez,
03900, Mexico, D.F.
Tel: 55-5804-0600

BRAZIL

Yamaha Musical do Brasil Ltda.
Rua Fidêncio Ramos, 302 - Cj. 54 - Torre B -
Vila Olímpia - CEP 04551-010 - São Paulo/SP
Tel: 011-3704-1377

ARGENTINA

**Yamaha Music Latin America, S.A.,
Sucursal Argentina**
Olga Cossetini 1553, Piso 4 Norte,
Madero Este-C1107CECE
Buenos Aires, Argentina
Tel: 54-11-4119-7000

VENEZUELA

**Yamaha Music Latin America, S.A.,
Sucursal Venezuela**
C.C. Manzanares Plaza P4
Ofic. 0401- Manzanares-Baruta
Caracas Venezuela
Tel: 58-212-943-1877

PANAMA AND OTHER LATIN AMERICAN COUNTRIES/ CARIBBEAN COUNTRIES

Yamaha Music Latin America, S.A.
Torre Banco General, Piso No.7, Marbella,
Calle 47 y Aquilino de la Guardia,
Ciudad de Panamá, República de Panamá
Tel: +507-269-5311

EUROPE

THE UNITED KINGDOM/IRELAND

Yamaha Music Europe GmbH (UK)
Sherbourne Drive, Tilbrook, Milton Keynes,
MK7 8BL, U.K.
Tel: 01908-366700

GERMANY

Yamaha Music Europe GmbH
Siemensstraße 22-34, 25462 Rellingen, Germany
Tel: 04101-3030

SWITZERLAND/LIECHTENSTEIN

**Yamaha Music Europe GmbH
Branch Switzerland in Zürich**
Seelefeldstrasse 94, 8008 Zürich, Switzerland
Tel: 044-387-8080

AUSTRIA

Yamaha Music Europe GmbH Branch Austria
Schleiergasse 20, A-1100 Wien, Austria
Tel: 01-60203900

CZECH REPUBLIC/HUNGARY/ ROMANIA/SLOVAKIA/SLOVENIA

**Yamaha Music Europe GmbH
Branch Austria (Central Eastern Europe Office)**
Schleiergasse 20, A-1100 Wien, Austria
Tel: 01-60203900

POLAND/LITHUANIA/LATVIA/ ESTONIA

**Yamaha Music Europe GmbH
Branch Poland Office**
ul. Wroclawska 14 02-553 Warsaw, Poland
Tel: +48 22 88 00 888

BULGARIA

Dinacord Bulgaria LTD.
Bul. Iskarsko Schose 7 Targowski Zentar Evropa
1528 Sofia, Bulgaria
Tel: 02-978-20-25

MALTA

Olimpus Music Ltd.
The Emporium, Level 3, St. Louis Street Msida
MSD06
Tel: 02133-2144

NETHERLANDS/BELGIUM/ LUXEMBOURG

Yamaha Music Europe Branch Benelux
Clarissenhof 5-b, 4133 AB Vianen, Netherlands
Tel: 0347-358 040

FRANCE

Yamaha Music Europe
7 rue Ambroise Croizat, Zone d'activités Pariest,
77183 Croissy-Beaubourg, France
Tel: 01-64-61-4000

ITALY

Yamaha Music Europe GmbH, Branch Italy
Viale Italia 88, 20020 Lainate (Milano), Italy
Tel: +34-91-639-8888

SPAIN/PORTUGAL

**Yamaha Music Europe GmbH Iberica, Sucursal
en España**
Ctra. de la Coruna km. 17,200, 28231
Las Rozas (Madrid), Spain
Tel: +34-91-639-8888

GREECE

Philippos Nakas S.A. The Music House
147 Skiathou Street, 112-55 Athens, Greece
Tel: 01-228 2160

SWEDEN

**Yamaha Music Europe GmbH Germany filial
Scandinavia**
J. A. Wettergrensgata 1, Box 30053
S-400 43 Göteborg, Sweden
Tel: +46 31 89 34 00

DENMARK

**Yamaha Music Europe GmbH, Tyskland - filial
Denmark**
Generøtorvej 6A, DK-2730 Herlev, Denmark
Tel: 44 92 49 00

FINLAND

F-Musiikki Oy
Kluuvikatu 6, P.O. Box 260,
SF-00101 Helsinki, Finland
Tel: 09 618511

NORWAY

**Yamaha Music Europe GmbH Germany -
Norwegian Branch**
Grini Næringspark 1, N-1361 Østerås, Norway
Tel: 67 16 78 00

ICELAND

Skiñan HF
Skeifan 17 P.O. Box 8120, IS-128 Reykjavik,
Iceland
Tel: 525 5000

RUSSIA

Yamaha Music (Russia) LLC.
Room 37, bld. 7, Kievskaya street, Moscow,
121059, Russia
Tel: 495 626 5005

TURKEY/CYPRUS

**Yamaha Music Europe GmbH
Merkezi Almanya Türkiye İstanbul Şubesi**
Maslak Meydan Sokak No:5 Spring Giz Plaza
Bağimsız Böl. No:3, 34398 Şişli, İstanbul
Tel: +90-212-999-8010

OTHER EUROPEAN COUNTRIES

Yamaha Music Europe GmbH
Siemensstraße 22-34, 25462 Rellingen, Germany
Tel: +49-4101-3030

AFRICA/MIDDLE EAST

SOUTH AFRICA

**Global Music Instruments
World of Yamaha**
19 Eastern Service Road, Eastgate Ext.6, Sandton,
South Africa
Tel: +27-11-259-7700

OTHER COUNTRIES

Yamaha Music Gulf FZE
LOB 16-513, P.O.Box 17328, Jebel Ali,
Dubai, United Arab Emirates
Tel: +971-4-881-5868

ASIA

THE PEOPLE'S REPUBLIC OF CHINA

Yamaha Music & Electronics (China) Co.,Ltd.
2F, Yunhedasha, 1818 Xinzha-lu, Jingan-qu,
Shanghai, China
Tel: 400-051-7700

HONG KONG

Tom Lee Music Co., Ltd.
11/F, Silvercord Tower 1, 30 Canton Road,
Tsimshatsui, Kowloon, Hong Kong
Tel: 2737-7688

INDIA

Yamaha Music India Pvt. Ltd.
Spazedge building, Ground Floor, Tower A, Sector
47, Gurgaon- Sohna Road, Gurgaon, Haryana, India
Tel: 0124-485-3300

INDONESIA

PT. Yamaha Musik Indonesia (Distributor)
Yamaha Music Center Bldg. Jalan Jend. Gatot
Subroto Kav. 4, Jakarta 12930, Indonesia
Tel: 021-520-2577

KOREA

Yamaha Music Korea Ltd.
8F, 9F, Dongsung Bldg. 158-9 Samsung-Dong,
Kangnam-Gu, Seoul, Korea
Tel: 02-3467-3300

MALAYSIA

Yamaha Music (Malaysia) Sdn., Bhd.
No.8, Jalan Perbandaran, Kelana Jaya, 47301
Petaling Jaya, Selangor, Malaysia
Tel: 03-78030900

SINGAPORE

Yamaha Music (Asia) Private Limited
Block 202 Hougang Street 21, #02-00,
Singapore 530202, Singapore
Tel: 65-6747-4374

TAIWAN

Yamaha Music & Electronics Taiwan Co.,Ltd.
2F, No.1, Yuanrong Rd. Banqiao Dist.
New Taipei City 22063 Taiwan
Tel: 02-7741-8888

THAILAND

Siam Music Yamaha Co., Ltd.
3, 4, 15 and 16th floor, Siam Motors Building,
891/1 Rama 1 Road, Wangmai,
Pathumwan, Bangkok 10330, Thailand
Tel: 02-215-2622

VIETNAM

Yamaha Music Vietnam Company Limited
15th Floor, Nam A Bank Tower, 201-203 Cach
Mang Thang Tam St., Ward 4, Dist.3,
Ho Chi Minh City, Vietnam
Tel: +84-8-3818-1122

OTHER ASIAN COUNTRIES

<http://asia.yamaha.com>

OCEANIA

AUSTRALIA

Yamaha Music Australia Pty. Ltd.
Level 1, 99 Queensbridge Street, Southbank,
Victoria 3006, Australia
Tel: 3-9693-5111

NEW ZEALAND

Music Works LTD
P.O.BOX 6246 Wellesley, Auckland 4680,
New Zealand
Tel: 9-634-0099

COUNTRIES AND TRUST

TERRITORIES IN PACIFIC OCEAN
<http://asia.yamaha.com>



Yamaha Web Site (English only)
<http://www.yamahasyth.com/>

Yamaha Downloads
<http://download.yamaha.com/>

Manual Development Department
© 2015 Yamaha Corporation

Published 06/2015 POBL*.*- **B0
Printed in China



ZP87460

ZP87460

Free Manuals Download Website

<http://myh66.com>

<http://usermanuals.us>

<http://www.somanuals.com>

<http://www.4manuals.cc>

<http://www.manual-lib.com>

<http://www.404manual.com>

<http://www.luxmanual.com>

<http://aubethermostatmanual.com>

Golf course search by state

<http://golfingnear.com>

Email search by domain

<http://emailbydomain.com>

Auto manuals search

<http://auto.somanuals.com>

TV manuals search

<http://tv.somanuals.com>