

YAMAHA

CC-75

Natural Sound Mini Component System
Chaîne Mini de la série "Natural Sound"
Natural Sound Mini Komponenten-System
Natural Sound Mini Komponent System
Sistema di Componenti Mini a Suono Naturale
Sistema de Componentes con Sonido Natural
Natural Sound Mini Component System

CC-75: RX-S75 + CDC-S75 + KXW-S75 + NX-S75

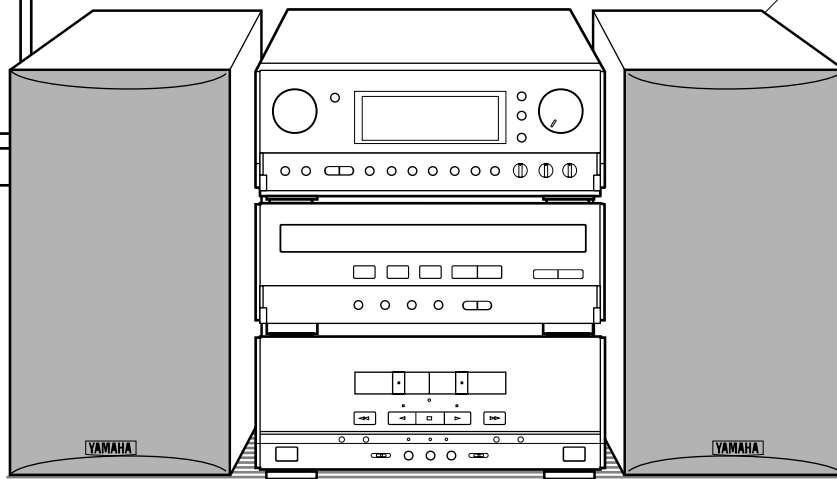
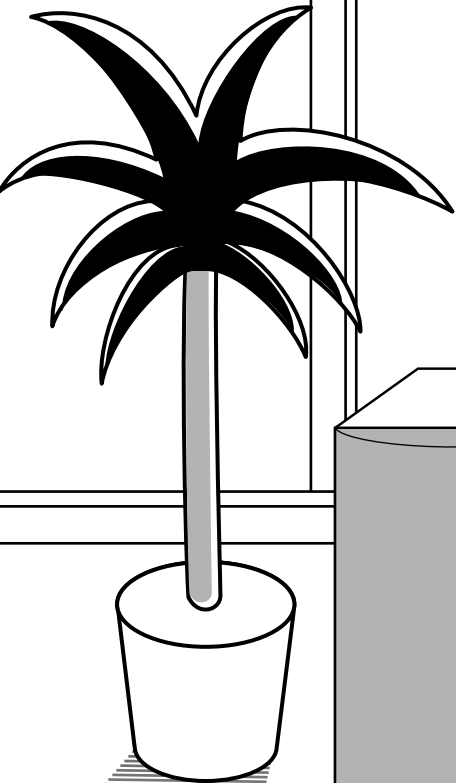

OWNER'S MANUAL
MODE D'EMPLOI
BEDIENUNGSANLEITUNG
BRUKSANVISNING
MANUALE DI ISTRUZIONI
MANUAL DE INSTRUCCIONES
GEbruIKSAANWIJZING

**SUPPLIED ACCESSORIES
ACCESSOIRES FOURNIS
MITGELIEFERTES ZUBEHÖR
MEDFÖLJANDE TILLBEHÖR
ACCESSORI IN DOTAZIONE
ACCESORIOS INCLUIDOS
BIJGELEVERDE ACCESSOIRES**

- After unpacking, check that the following parts are contained.
- Après le déballage, vérifier que les pièces suivantes sont incluses.
- Nach dem Auspacken überprüfen, ob die folgenden Teile vorhanden sind.
- Kontrollera efter det apparaten packats upp att följande delar finns med.
- Verificare che tutte le parti seguenti siano contenute nell'imballaggio dell'apparecchio.
- Desembale el aparato y verificar que los siguientes accesorios están en la caja.
- Controleer na het uitpakken of de volgende onderdelen voorhanden zijn.

- Remote control transmitter
- Télécommande
- Fernbedienung
- Fjärrkontroll
- Telecomando
- Controlador remoto
- Afstandbediening

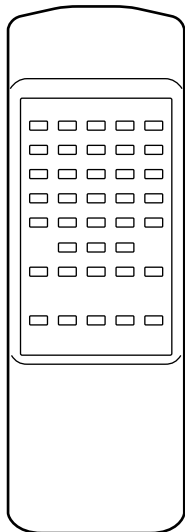
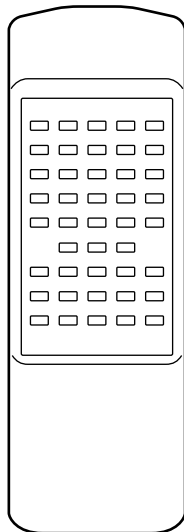

<Except U.K. and Europe Models>
<Excepté le modèles pour le Royaume-Uni et l'Europe>
<Außer Großbritannien- und Europa-Modelle>
<Undantaget modell för Storbritannien och Europa>
<Ecceetto modelli per Gran Bretagna e l'Europa>
<Excepto modelos para Reino Unido y Europa>
<Behalve de modellen voor Groot-Brittannië en Europa>

<U.K. and Europe models>
<Modèles pour le Royaume-Uni et l'Europe>
<Großbritannien- und Europa-Modelle>
<Modell för Storbritannien och Europa>
<Modelli per Gran Bretagna e l'Europa>
<Modelos para Reino Unido y Europa>
<Modellen voor Groot-Brittannië en Europa>

- Batteries (size AA, UM/SUM-3, R6, HP-7)
- Piles (format AA, UM/SUM-3, R6, HP-7)
- Batterien (Größe AA, UM/SUM-3, R6, HP-7)
- Batterier (Storl. AA, UM/SUM-3, R6, HP-7)
- Batterie (dimensioni AA, o UM/SUM-3, o R6, o HP-7)
- Pilas (tamaño AA, tipo UM/SUM-3, R6, HP-7)
- Batterijen (maat AA, UM/SUM-3, R6, HP-7)

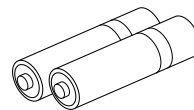

- AM (MW/LW) loop antenna
- Cadre-antenne AM (PO/GO)
- MW/LW-Rahmenantenne
- MV/LV ramantenn
- Antenna ad anello per AM (MW e LW)
- Antena de cuadro AM (OM/OL)
- AM (MW/LW) lusantenne

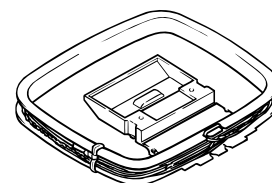

- Indoor FM antenna
- Antenne intérieure FM
- UKW-Innenantenne
- FM inomhusantenn
- Antenna FM per interni
- Antena interior de FM
- FM binnenantenne

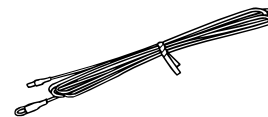

- Speaker cords (for NX-S75)
- Câbles d'enceintes (pour les enceintes NX-S75)
- Lautsprecheranschlusskabel (für NX-S75)
- Högtalarledning (för NX-S75)
- Cavi per gli altoparlanti (per l'NX-S75)
- Cables de los altavoces (para el NX-S75)
- Luidsprekerdraden (voor NX-S75)

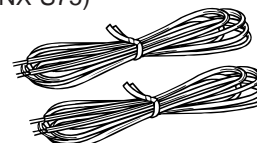

This product complies with the radio frequency interference requirements of the Council Directive 82/499/EEC and/or 87/308/EEC.

Cet appareil est conforme aux prescriptions de la directive communautaire 87/308/CEE.

Diese Geräte entsprechen der EG-Richtlinie 82/499/EWG und/oder 87/308/EWG.

Dette apparat overholder det gældende EF-direktiv vedrørende radiostøj.

Questo apparecchio è conforme al D.M.13 aprile 1989 (Direttiva CEE/87/308) sulla soppressione dei radiodisturbi.

Este producto está de acuerdo con los requisitos sobre interferencias de radio frecuencia fijados por el Consejo Directivo 87/308 CEE.

Dit product voldoet aan de EEG normen betreffende radio-frekventie storingen 82/499/EEG en/of 87/308/EEG.

1 CDC-S75

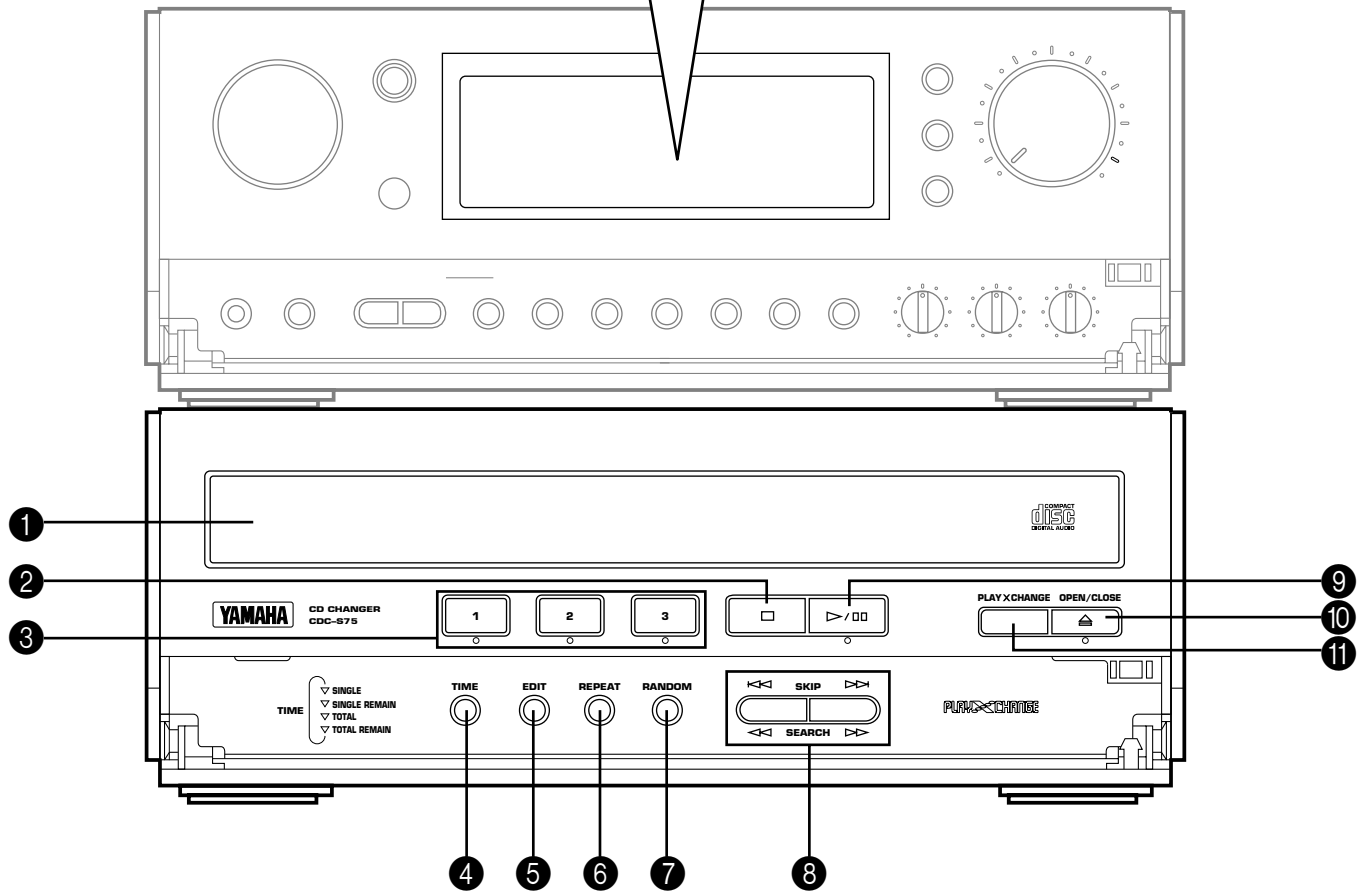
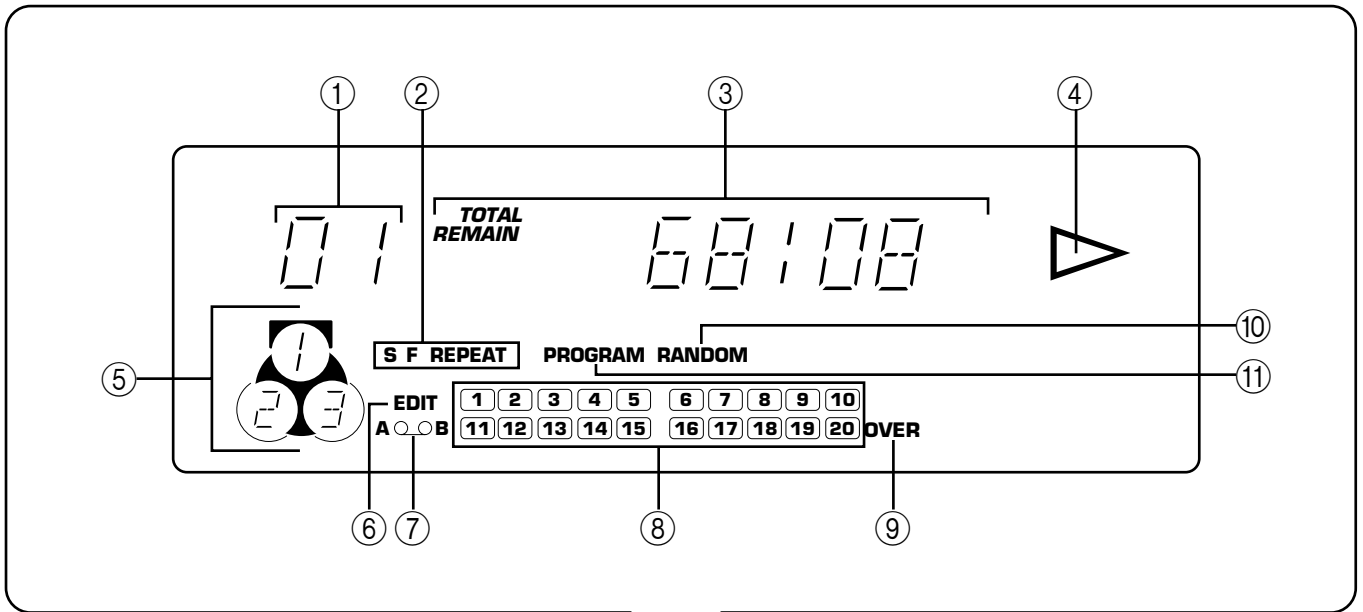

2 **RX-S75**

<Except U.K. and Europe Models>
 <Excepté le modèles pour le Royaume-Uni et l'Europe>
 <Außer Großbritannien- und Europa-Modelle>
 <Undantaget modell för Storbritannien och Europa>
 <Eccetto modelli per Gran Bretagna e l'Europa>
 <Excepto modelos para Reino Unido y Europa>
 <Behalve de modellen voor Groot-Brittannië en Europa>

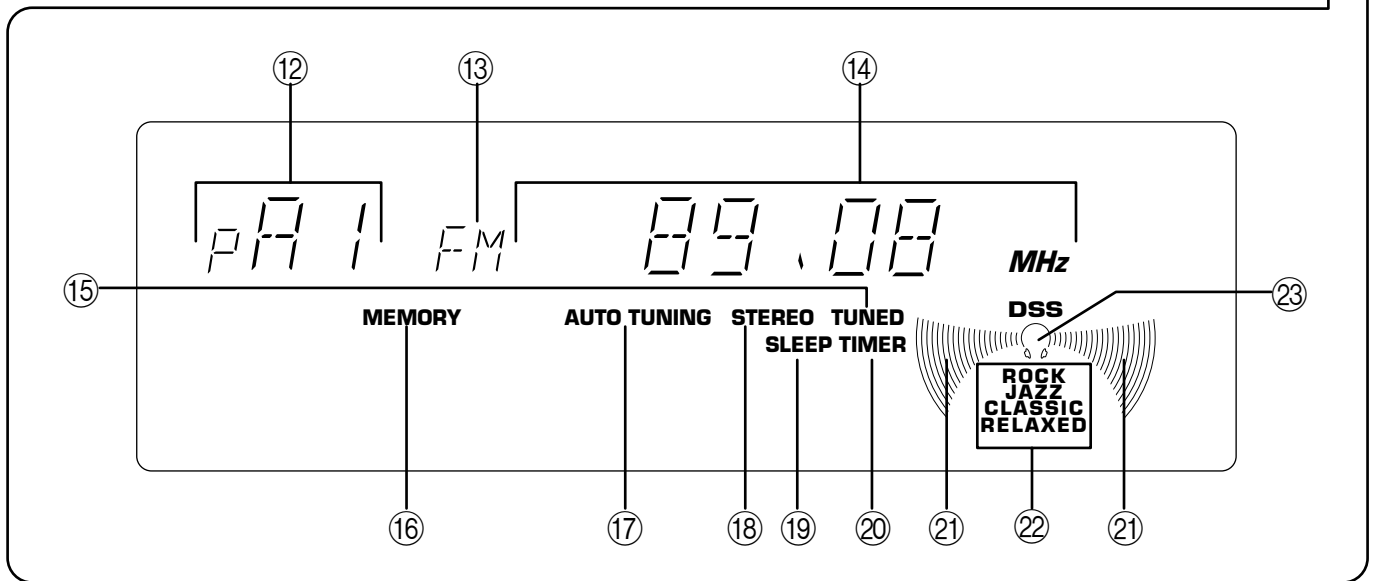
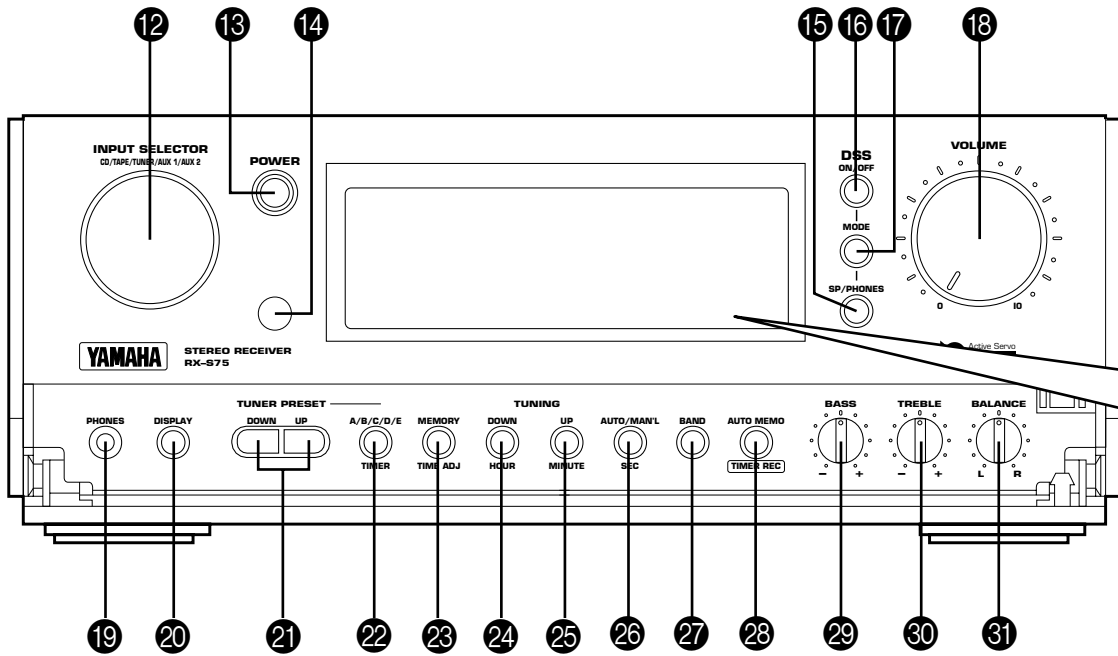

<U.K. and Europe models>
 <Modèles pour le Royaume-Uni et l'Europe>
 <Großbritannien- und Europa-Modelle>
 <Modell für Storbritannien och Europa>
 <Modelli per Gran Bretagna e l'Europa>
 <Modelos para Reino Unido y Europa>
 <Modellen voor Groot-Brittannië en Europa>

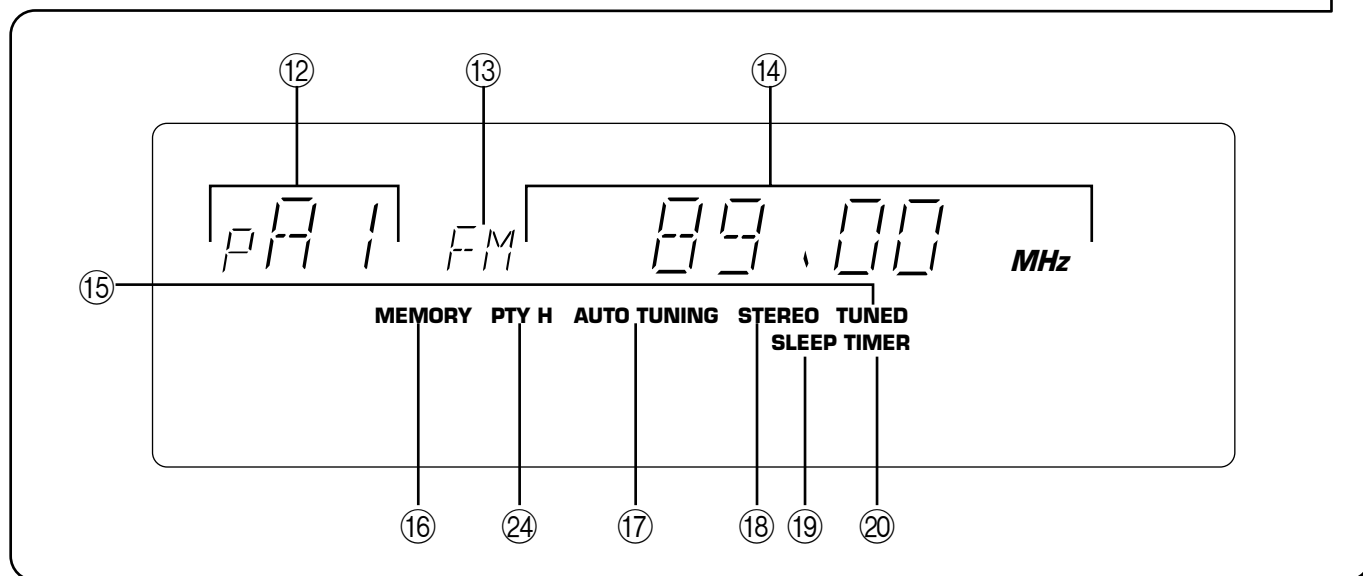
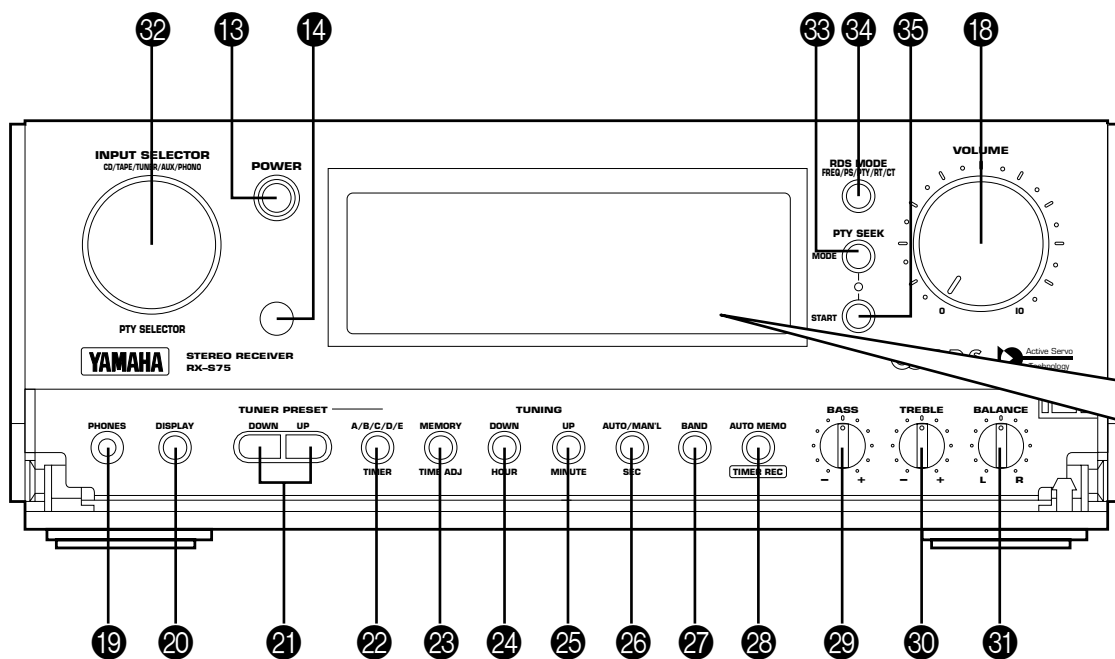

3 **KXW-S75**

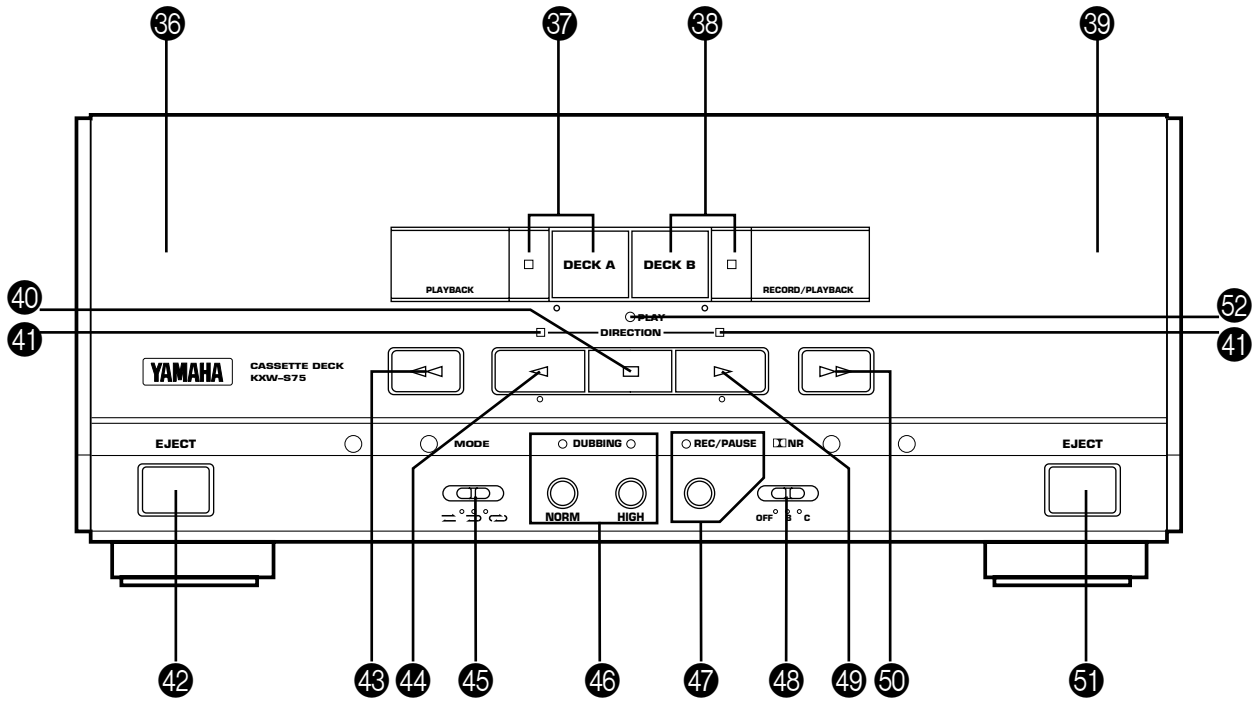

4 **NX-S75**

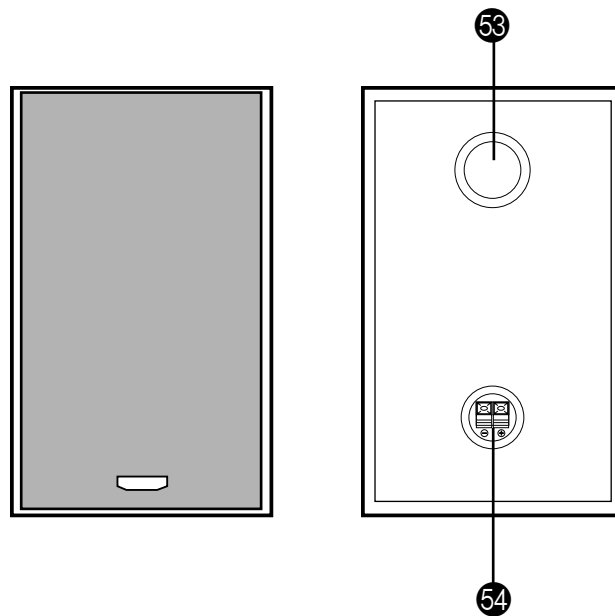

5

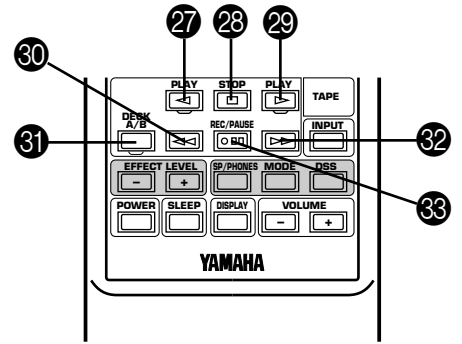
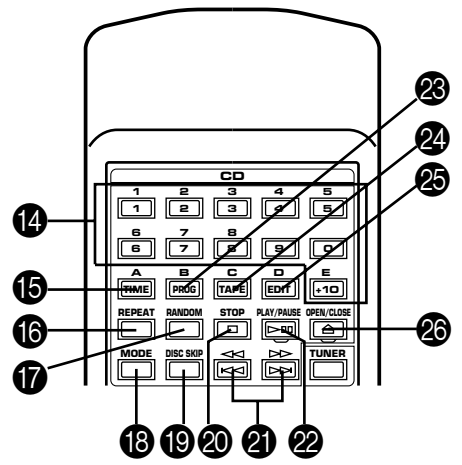
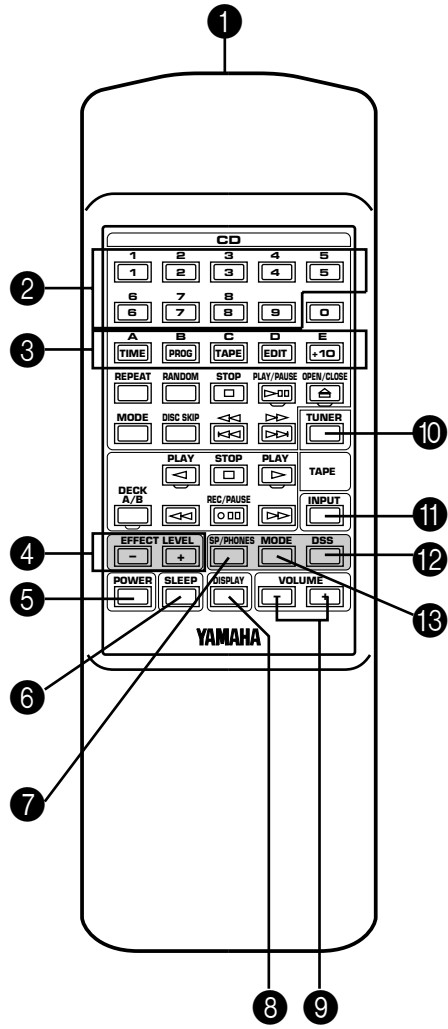

6

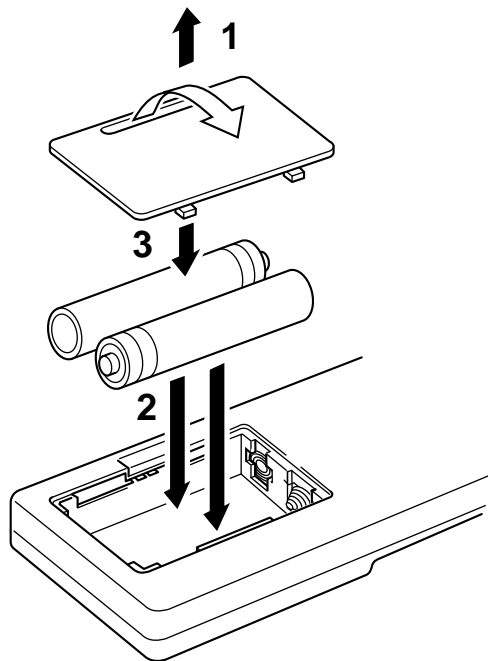

7

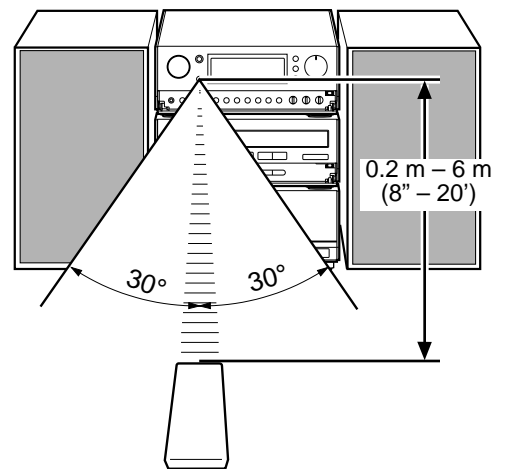

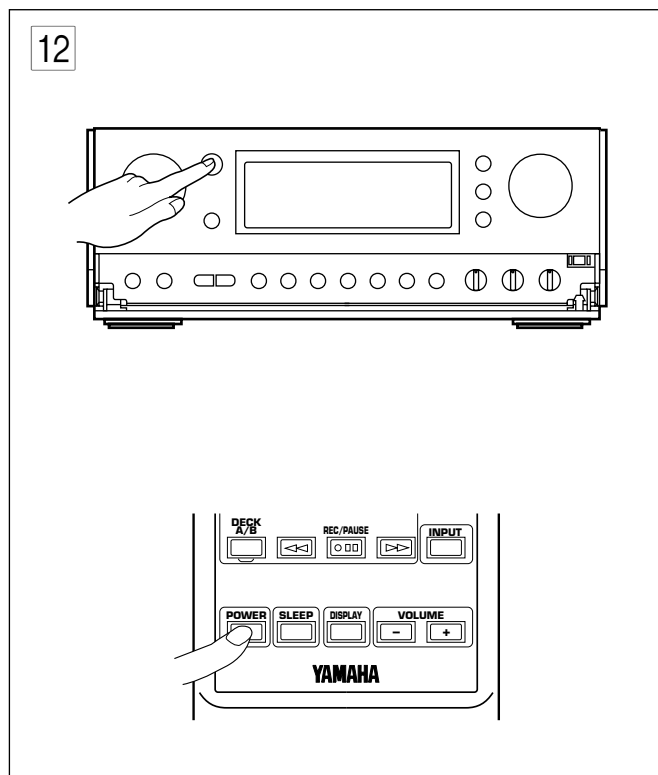
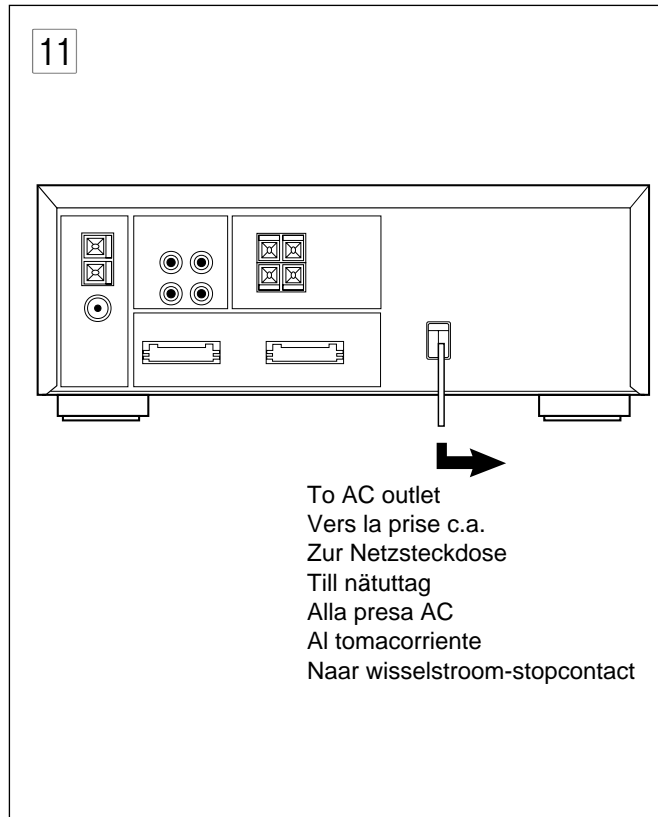
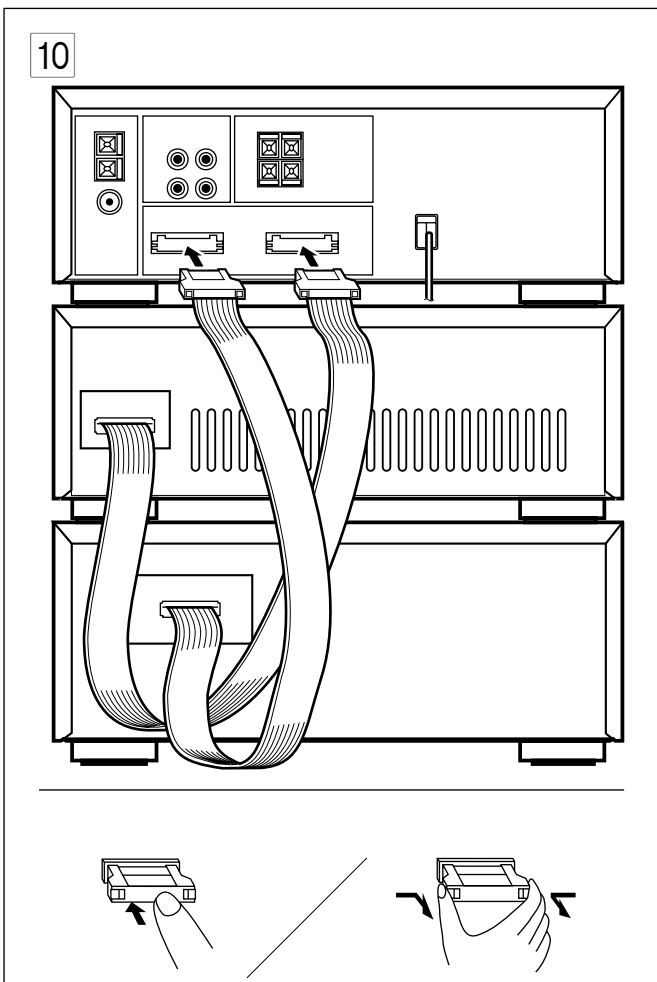
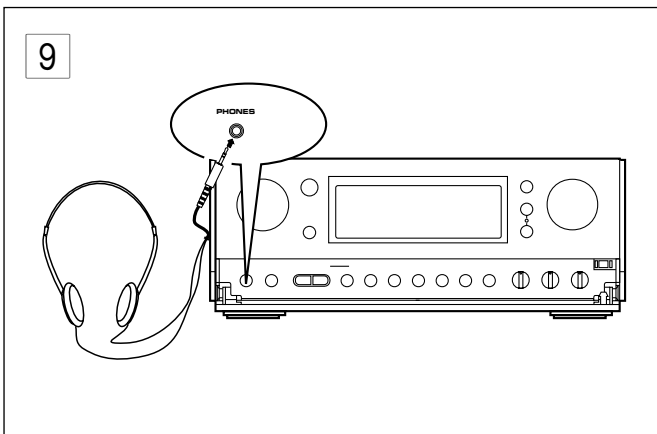
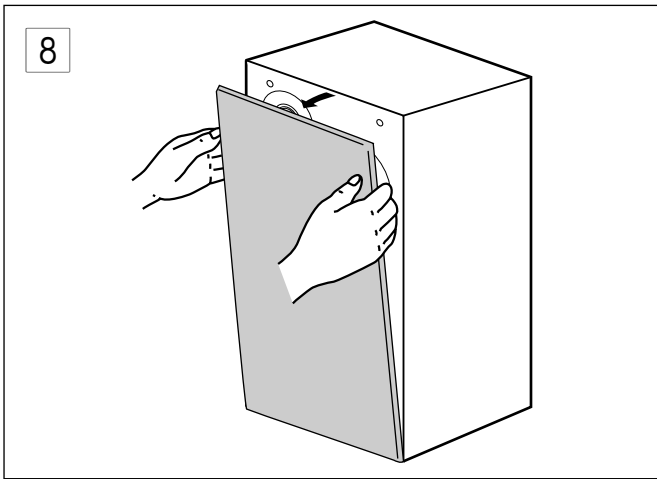

INTRODUCTION

Thank you for purchasing this YAMAHA product. We hope it will give you many years of trouble-free enjoyment. For the best performance, read this manual carefully. It will guide you in operating your YAMAHA product.

FEATURES

- 75W + 75W (6Ω) Output Power, 10% THD, 1 kHz
 - Random Access Programmable CD Playback
 - Single Track/Entire Disc/All Disc Repeat Play
 - Random-sequence Play
 - Automatic Synchronized Recording with CD Playback
 - Automatic CD Editing Function for Recording to Tape
 - Double Cassette Tape Deck with Automatic Reversing Function
 - 2-Way Speed Dubbing
 - Dolby B/C Noise Reduction System
 - 40 Station Automatic Preset Tuning
 - Multi-Use Timer/Sleep Timer
 - Active Servo Processing Speaker System (NX-S75)
 - Remote Control Capability
- <Except U.K. and Europe models >
- 4-Mode Digital Super Surround (DSS) Processor
 - Digital Super Surround Effective Even by Listening with Headphones
- <U.K. and Europe models >
- Multi-Functions for RDS Broadcast Reception

CONTENTS

	Page		Page
PRECAUTIONS	2-3	COMPACT DISC PLAYER OPERATION.....	11-18
SETTING UP THE SYSTEM	3	TUNING OPERATION	19-21
NAMES OF CONTROLS AND INDICATORS	4-5	RECEIVING RDS STATIONS	
REMOTE CONTROL TRANSMITTER.....	5-6	<U.K. and Europe models only>	22-25
REMOVING THE FRONT GRILLE	6	TAPE DECK OPERATION	26-29
LISTENING WITH HEADPHONES	6	RECORDING COMPACT DISCS	30-35
OPEN/CLOSE THE CONTROL DOOR	6	OTHER RECORDINGS.....	36-37
CONNECTIONS.....	7-8	HOW TO USE THE BUILT-IN TIMER.....	38-41
TURNING THE POWER ON/OFF TO THIS SYSTEM	8	USING EXTERNAL UNITS	42
SETTING THE CLOCK	9	MAINTENANCE	43
SOUND CONTROL	10	TROUBLESHOOTING	44
DIGITAL SUPER SURROUND (DSS) PROCESSOR		SPECIFICATIONS.....	45
CONTROL <Except U.K. and Europe models>	10-11		

For basic source play, the following illustrations on top of pages will help you to look for the section you need.



.....CD playback



.....Tuning



.....Tape playback/recording

PRECAUTIONS: READ THIS BEFORE OPERATING YOUR UNIT

- To assure the finest performance, please read this manual carefully. Keep it in a safe place for future reference.
- This system is equipped with the newly developed Active Servo Processing Speaker System. It is not designed for use with conventional speakers. Therefore, **do not attempt to connect other speakers than the provided speaker system.**
- Choose the installation location of this unit carefully. Avoid placing it in direct sunlight or close to a source of heat. Also avoid locations subject to vibration and excessive dust, heat, cold or moisture. Keep it away from sources of hum such as transformers and electric motors.
- Do not operate this unit upside-down. It may overheat, possibly causing damage.
- Never open the cabinet. If something drops into the set, contact your dealer.
- The openings on the cabinet assure proper ventilation of the unit. If these openings are obstructed, the temperature inside the cabinet will rise rapidly and eventually damage the circuits. Therefore, avoid placing objects against these openings and do not install the unit where the flow of air through the ventilation openings could be impeded.
- Always set the VOLUME control to minimum before starting the audio source: increase the volume gradually to an appropriate level after play has started.
- When not planning to use this unit for long periods of time (ie., vacation, etc.), disconnect the AC power plug from the wall outlet.
- Grounding or polarization – Precautions should be taken so that the grounding or polarization of an appliance is not defeated.
- Do not use force on switches, controls or connection wires. When moving the unit, first disconnect the power plug and the wires connected to other equipment. Never pull the wire itself.
- Do not attempt to clean the unit with chemical solvents; this might damage the finish. Use a clean, dry cloth.
- Be sure to read the "TROUBLESHOOTING" section regarding common operating errors before concluding that the unit is faulty.
- To prevent lightning damage, disconnect the AC power plug and the antenna cable when there is an electrical storm.
- Do not plug the AC power plug to the wall socket before you finish all connections.
- Never allow metallic items (e.g. screwdrivers, tools, etc.) to come near the cassette deck's record/playback head assembly in this unit. Doing so may not only scratch or damage the head's mirror-smooth finish, it may change the magnetic characteristics of the heads, causing a deterioration in reproduction performance quality.
- Although the cassette deck's record/playback heads used in this unit are high quality heads with outstanding reproduction characteristics, they can become dirty through the use of old tapes or from dust accumulation over time. This can have a serious effect on reproduction quality. Clean the heads regularly with one of the commonly available head cleaners or with cleaning solutions.
- The voltage to be used must be the same as that specified on this unit. Using this product with a higher voltage than that which is specified is dangerous and may result in a fire or other type of accident causing damage. YAMAHA will not be held responsible for any damage resulting from use of this unit with a voltage other than that which is specified.
- The sound level at a given volume setting depends on speaker location and other factors. Care should be taken to avoid exposure to sudden high levels of sound, which may occur when turning on the unit with the volume control setting at high, and to continuous high levels of sound.
- Sudden temperature changes and storage or operation in an extremely humid environment may cause condensation inside the cabinet. Condensation can cause the unit to malfunction. To eliminate condensation:

- **CD pickup**

Leave the power on with no disc in the unit until normal playback is possible (about 1 hour).

- **Tape head**

Leave the power on with no cassette in the unit until normal playback is possible (about 1 hour).

Note

If condensation forms on the tape head, foreign matter may accumulate during use.

- **Remote control**

Wipe off condensation on the transmitter window with a soft cloth before operating the unit.

IMPORTANT

Please record the serial number of this unit in the space below.

Serial No.:

The serial number is located on the rear of the unit.

Retain this Owner's Manual in a safe place for future reference.

WARNING

TO REDUCE THE RISK OF FIRE OR ELECTRIC SHOCK, DO NOT EXPOSE THIS APPLIANCE TO RAIN OR MOISTURE.

CAUTION (FOR CANADA MODEL)

TO PREVENT ELECTRIC SHOCK, MATCH WIDE BLADE OF PLUG TO WIDE SLOT AND FULLY INSERT.

FOR CANADIAN CUSTOMER

THIS CLASS B DIGITAL APPARATUS MEETS ALL REQUIREMENTS OF THE CANADIAN INTERFERENCE-CAUSING EQUIPMENT REGULATIONS.

NOTE

Please check the copyright laws in your country to record from records, compact discs, radio, etc. Recording of copyright material may infringe copyright laws.

For U.K. customers

If the socket outlets in the home are not suitable for the plug supplied with this appliance, it should be cut off and an appropriate 3 pin plug fitted. For details, refer to the instructions described below.

Note: The plug severed from the mains lead must be destroyed, as a plug with bared flexible cord is hazardous if engaged in a live socket outlet.

SPECIAL INSTRUCTIONS FOR U.K. MODEL

IMPORTANT:

The wire in the mains lead are coloured in accordance with the following code:

Blue: NEUTRAL

Brown: LIVE

The colours of the wires in the mains lead of this apparatus may not correspond with the coloured markings identifying the terminals in your plug. Proceed as follows: the wire which is coloured BLUE must be connected to the terminal which is marked with the letter N or coloured BLACK. The wire which is coloured BROWN must be connected to the terminal which is marked with the letter L or coloured RED. Making sure that neither core is connected to the earth terminal of the three pin plug.

PRECAUTIONS: READ THIS BEFORE OPERATING YOUR UNIT

CAUTION FOR CARRYING THIS UNIT

Be sure not to carry or tip this unit with discs remaining in it.

CAUTION FOR MOVING THIS UNIT

Before moving this unit, first remove all discs from the disc table and close the table by pressing the OPEN/CLOSE button, and then switch off the power by pressing the POWER switch, and last, after you confirm that "no disc" is illuminated on the display, disconnect the power plug from the AC outlet.

The apparatus is not disconnected from the AC power source as long as it is connected to the wall outlet, even if the apparatus itself is turned off.

VOLTAGE SELECTOR (General model only)

The voltage selector on the rear panel of this unit must be set for your local main voltage BEFORE plugging into the AC main supply.

Voltages are 110/120/220/240V AC, 50/60 Hz.

WARNING

To reduce the risk of fire or electric shock, do not expose this unit to rain or moisture.

To avoid electrical shock, do not open the cabinet. Refer servicing to qualified personnel only.

CAUTION 1

Use of controls or adjustments or performance of procedures other than those specified herein may result in hazardous radiation exposure.

CAUTION 2

As the laser beam used in this unit is harmful to the eyes, do not attempt to disassemble the cabinet. Refer servicing to qualified personnel only.

CLASS 1 LASER PRODUCT
LUOKAN 1 LASERLAITE
KLASS 1 LASERAPPARAT

This unit is classified as a CLASS 1 LASER product. The CLASS 1 LASER PRODUCT label is located on the rear exterior. (Europe and U.K. model only)

Laser component in this product is capable of emitting radiation exceeding the limit for Class 1.

Laser Diode Properties

- Material: GaAlAs
- Wavelength: 780nm
- Emission Duration: continuous
- Laser Output: max. 44.6μW*

* This output is the value measured at a distance of about 200mm from the objective lens surface on the Optical Pick-up Block.

SETTING UP THE SYSTEM

Setup examples

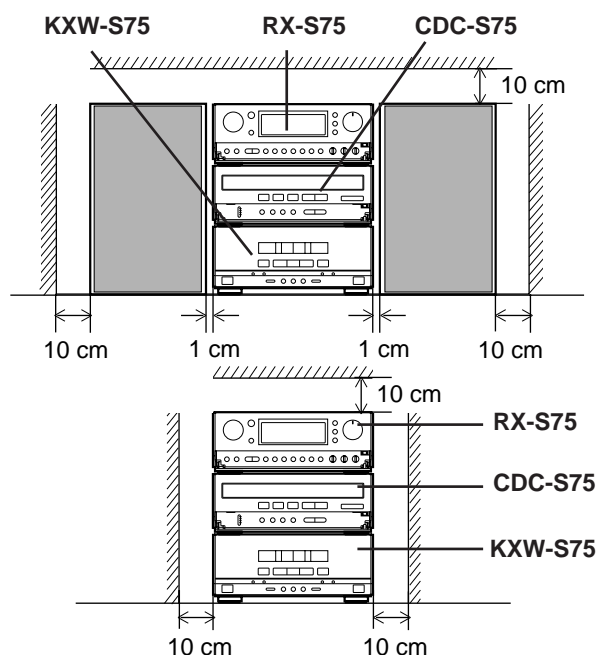

Place this system as illustrated on the left and allow spaces more than indicated around the system and more than 10 cm (3-15/16") behind the system to assure good ventilation. Be sure not to place another unit or any object on top of the receiver (RX-S75) to prevent the ventilation holes on the top panel of the receiver from being obstructed. Otherwise, it may cause fire or damage to the receiver.

Notes

- When placing the speakers apart from the main units, allow a space of at least 10 cm (3-15/16") from above, behind and on the both sides of the main units.
- If the system is put in a rack, the front of it must be fully opened.
- Disconnect the AC supply lead from the AC outlet before connecting or disconnecting any component.

NAMES OF CONTROLS AND INDICATORS

(See figure 1 and 2 on page 3 – 5 at the beginning part of this manual.)

CD player (CDC-S75)

- 1 Disc Table
- 2 Stop Button: □
- 3 Disc Selector Buttons
- 4 **TIME** Button
- 5 **EDIT** Button
- 6 **REPEAT** Button
- 7 **RANDOM** Button
- 8 **SKIP** Buttons: ◀◀/▶▶
(**SEARCH** Buttons: ◀◀/▶▶)
- 9 Play/Pause Button: ▷/⏸
- 10 **OPEN/CLOSE** Button: ⏏
- 11 **PLAYXCHANGE** Button

Receiver (RX-S75)

- 12 **INPUT SELECTOR** Control
- 13 **POWER** Switch
- 14 Remote Control Sensor
- 15 **SP/PHONES** Mode Selector Button
- 16 **DSS ON/OFF** Selector Button
- 17 **DSS MODE** Selector Button
- 18 **VOLUME** Control
- 19 **PHONES** Jack
- 20 **DISPLAY** Button
- 21 **TUNER PRESET DOWN/UP** Buttons
- 22 **A/B/C/D/E (TIMER)** Button
- 23 **MEMORY (TIME ADJUST)** Button
- 24 **TUNING DOWN (HOUR)** Button
- 25 **TUNING UP (MINUTE)** Button
- 26 **AUTO/MAN'L (SEC)** Button
- 27 **BAND** Selector Button
- 28 **AUTO MEMORY (TIMER REC)** Button
- 29 **BASS** Tone Control
- 30 **TREBLE** Tone Control
- 31 **BALANCE** Control
- 32 **INPUT SELECTOR (PTY SELECTOR)** Control
- 33 **PTY SEEK MODE** Button
- 34 **RDS MODE** Selector Button
- 35 **PTY SEEK START** Button

Display

For CD player

- 1 Track Number Indicator
- 2 **(S, F) REPEAT** Indicator
- 3 Time Display
- 4 Play Indicator: ▷
- 5 Disc Indicator
- 6 **EDIT** Indicator
- 7 Tape Side Indicator
- 8 Music Calendar Indicator
- 9 Music Calendar **OVER** Indicator
- 10 **RANDOM** Play Indicator
- 11 **PROGRAM** Indicator

For receiver

- 12 Preset Number Indicator
- 13 Band Indicator
- 14 Station Frequency Display
- 15 **TUNED** Indicator
- 16 **MEMORY** Indicator
- 17 **AUTO TUNING** Indicator
- 18 **STEREO** Indicator
- 19 **SLEEP** Indicator
- 20 **TIMER** Set Indicator
- 21 Effect Level Indicator
- 22 DSS Mode Indicators
- 23 Phones Mode Indicator
- 24 **PTY H** Indicator

NAMES OF CONTROLS AND INDICATORS

(See figure 3 and 4 on page 6 at the beginning part of this manual.)

Tape deck (KXW-S75)

- 36 DECK A Cassette Compartment
- 37 **DECK A** Selector Button and Indicator
- 38 **DECK B** Selector Button and Indicator
- 39 DECK B Cassette Compartment
- 40 Stop Button: □
- 41 Play Direction Indicators
- 42 DECK A **EJECT** Button
- 43 Fast Wind Button: <<
- 44 Play Button: <
- 45 Reverse **MODE** Switch
- 46 **DUBBING (NORMAL/HIGH)** Buttons and Indicators

- 47 **REC/PAUSE** Button and Indicator
- 48 **DOLBY NR** Switch
- 49 Play Button: ▷
- 50 Fast Wind Button: ▷▷
- 51 DECK B **EJECT** Button
- 52 **PLAY** Indicator

Speakers (NX-S75)

- 53 YST Port
- 54 Speaker Terminals

REMOTE CONTROL TRANSMITTER

Names of control buttons

(See figure 5 on page 7 at the beginning part of this manual.)

Receiver control buttons

- 1 Remote Control Transmitter Window
- 2 Preset Station Number Buttons
- 3 **A, B, C, D, E** Selector Buttons
- 4 **EFFECT LEVEL** – (Down)/+ (Up) Buttons
- 5 **POWER** Switch
- 6 **SLEEP** Button
- 7 **SP/PHONES** Mode Selector Button
- 8 **DISPLAY** Button
- 9 **VOLUME** – (Down)/+ (Up) Buttons
- 10 **TUNER** Input Selector Button
- 11 **INPUT** Selector Button
- 12 **DSS** On/Off Button
- 13 **DSS MODE** Selector Button

CD player control buttons

- 14 Track Number Input Buttons
- 15 **TIME** Button

- 16 **REPEAT** Button
- 17 **RANDOM** Button
- 18 Disc Play **MODE** Selector Button
- 19 **DISC SKIP** Button
- 20 **STOP** Button: □
- 21 Skip Buttons: <</>>
(Search Buttons: <<</>>>)
- 22 **PLAY/PAUSE** Button: ▷ ■■
- 23 **PROGRAM** Button
- 24 **TAPE** Button
- 25 **EDIT** Button
- 26 **OPEN/CLOSE** Button: ▲

Tape deck control buttons

- 27 Play Button: <
- 28 Stop Button: □
- 29 Play Button: ▷
- 30 Fast Wind Button: <<
- 31 **DECK A/B** Button
- 32 Fast Wind Button: ▷▷
- 33 **REC/PAUSE** Button: ○ ■■

* Parts in shaded areas on the figure 5 are not equipped on U.K. and Europe models.
This manual mainly uses illustrations for U.K. and Europe models.

REMOTE CONTROL TRANSMITTER

Loading the batteries for the remote control transmitter

(See figure 6 on page 7.)

- 1 Remove the battery compartment cover.
(Press the left edge of the cover to right with a finger, and then pull it upward.)
- 2 Insert 2 "AA" size batteries (UM/SUM-3, R6, HP-7 or equivalent) into the battery compartment.
* Installing the batteries improperly may cause failure.
- 3 Replace the battery compartment cover.

Precautions for battery use

- Insert the batteries according to the direction indicated in the battery compartment.
- Replace all batteries with new ones at the same time.
- Remove the batteries if they are weak or if the unit is not in use for long periods.
- Don't mix normal batteries with rechargeable batteries.

Proper use of the remote control transmitter

(See figure 7 on page 7.)

Aim (within the range of 60° with no obstacles) the remote control transmitter at the remote control sensor and operate as shown.

Notes concerning use

- Replace the batteries if control distance decreases or operation becomes unstable.
- Periodically clean the transmitter window on the remote control transmitter and the sensor on the main unit with a soft cloth.
- Exposing the sensor on the main unit to strong light (especially an inverter type of fluorescent lamp etc.) may interfere with operation. In this case, reposition the main unit to avoid direct lighting.
- Keep the remote control transmitter away from moisture, excessive heat, shock and vibrations.
- The remote control transmitter's usable range is within 0.2m (8") and 6m (20') away from the sensor.

REMOVING THE FRONT GRILLE

(See figure 8 on page 8.)

The front grille is fastened to the enclosure at four points, and can be removed if desired. To remove the grille, hold on to both sides and slowly pull straight away from the speaker. To reattach, line up the four pegs on the speaker with the four corresponding holes on the inside surface of the grille and push gently.

Note

When the grille is removed, take care not to touch the speaker units with your hands or to exert excessive force with tools.

LISTENING WITH HEADPHONES

(See figure 9 on page 8.)

- Be sure that your headphones have a 3.5 mm (1/8") diameter plug and are between 16 ohms and 50 ohms impedance. Recommended impedance is 32 ohms.
- When headphones are connected, the speakers are defeated automatically. Adjust the VOLUME control for desired volume.

OPEN/CLOSE THE CONTROL DOOR

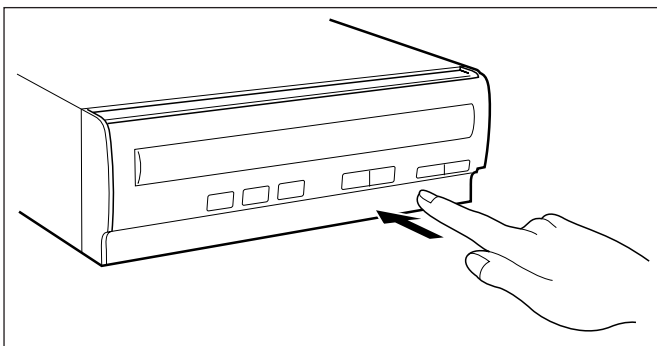

When it is not necessary to operate controls inside the control door, close the door.

To open or close the door, press the right edge until it clicks.

CONNECTIONS

Never plug the AC supply lead of this system into the AC outlet until all connections are completed.

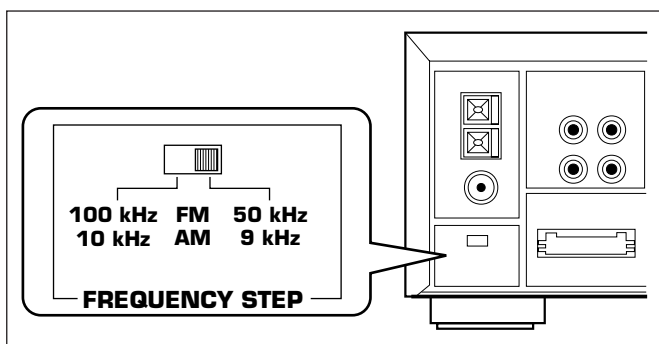
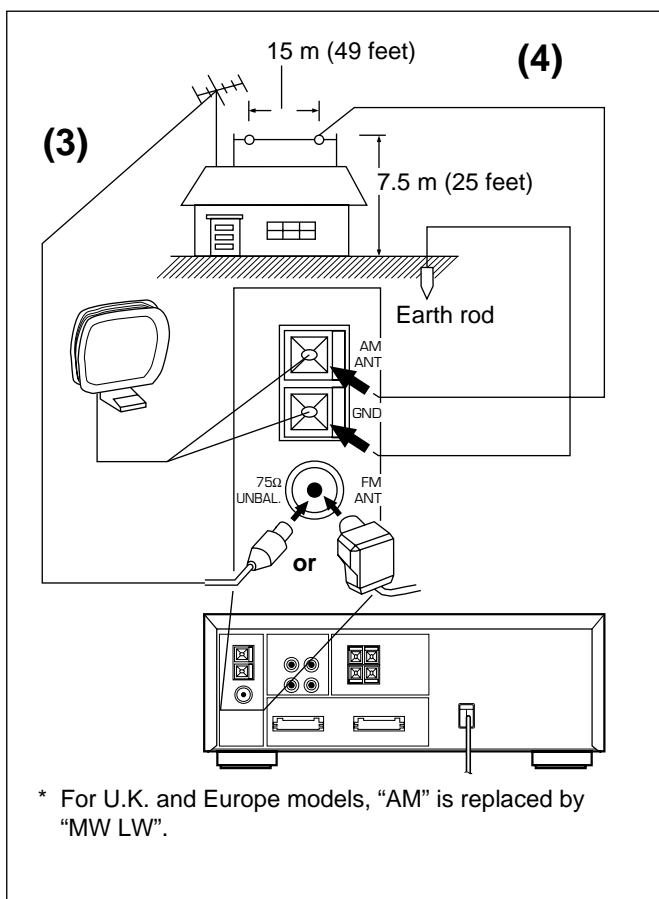
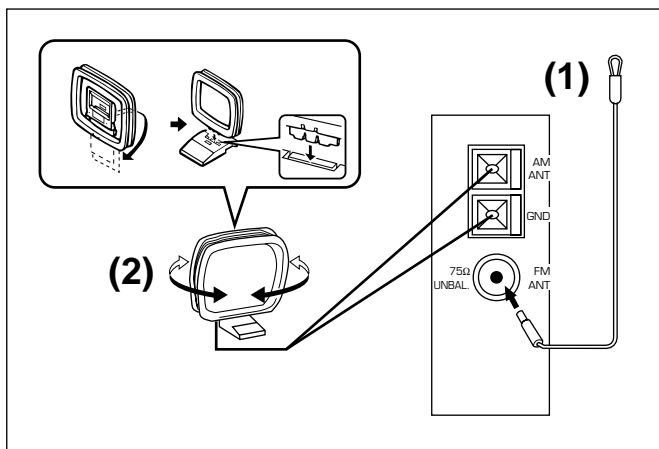

Antenna connection

(1) Supplied FM antenna

Connect the FM antenna wire to the corresponding terminal and direct the FM antenna wire to the direction where the strongest signal can be received.

(2) Supplied AM (MW/LW) loop antenna

Connect the AM (MW/LW) loop antenna wires to the corresponding terminals. Position the AM (MW/LW) loop antenna for optimum reception. Place the AM (MW/LW) loop antenna on a shelf etc., or install it on the rack or wall with screws (not supplied).

Notes

- When static is still heard even after adjusting the position of the AM (MW/LW) loop antenna, try reversing the wire connections (top to bottom).
- Do not place the AM (MW/LW) loop antenna on the unit. It will result in noise generation, since the unit is equipped with digital electronics. Place the AM (MW/LW) loop antenna away from the unit.

(3) External FM antenna

Use an external FM antenna instead of an indoor FM antenna if you need better reception. Consult your dealer.

(4) External AM (MW/LW) antenna

Use an external AM (MW/LW) antenna if you need better reception. Consult your dealer.

Note

When using an external AM (MW/LW) antenna, be sure to keep the wire of the AM (MW/LW) loop antenna connected.

FREQUENCY STEP switch (General model only)

Because the interstation frequency spacing differs in different areas, set the FREQUENCY STEP switch (located at the rear) according to the frequency spacing in your area. Before setting this switch, disconnect the AC supply lead of this unit from the AC outlet.

CONNECTIONS

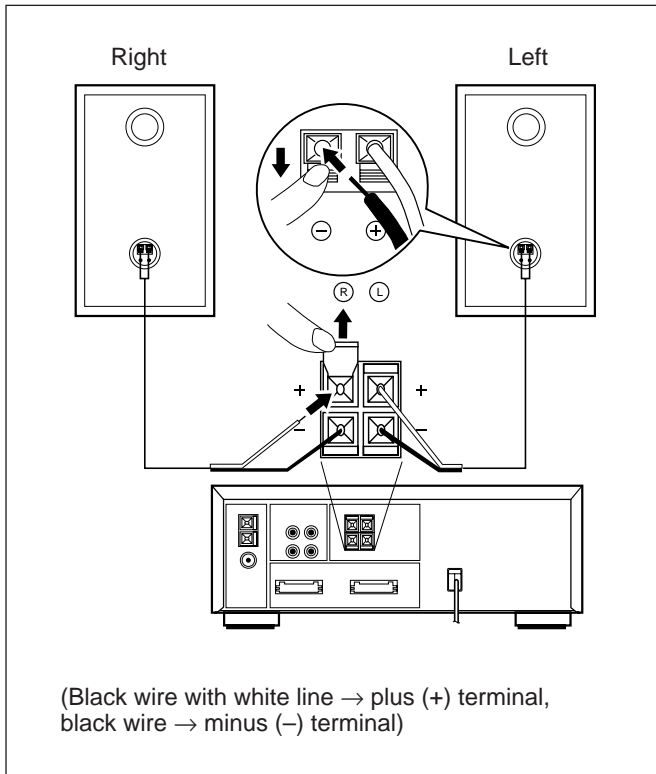

Speaker connection

Connect each speaker wire to the SPEAKERS terminals.

Cautions

- Do not let the bare speaker wires touch each other as this could damage the receiver and/or speakers.
- When connecting the speakers to the unit, be sure to connect the speaker wires properly. Do not make a mistake from the right channel to the left channel and from the plus (+) terminal to the minus (-) terminal.
- Do not connect these SPEAKERS terminals to speakers other than the provided speaker system NX-S75.

System connection

(See figure 10 on page 8.)

- Connect the red connector on the rear of CDC-S75 to the red socket on the rear of RX-S75.
- Connect the black connector on the rear of KXW-S75 to the black socket.

How to disconnect the system connector

Grasp both sides of the connector to disconnect the connector.

Connecting the AC supply lead

(See figure 11 on page 8.)

- After connecting the speakers and system connectors, plug the AC supply lead into a convenient AC outlet.
- Unplug the AC supply lead from the AC outlet if the unit is not to be used for a long period of time.

TURNING THE POWER ON/OFF TO THIS SYSTEM

(See figure 12 on page 8.)

If the AC supply lead is connected to the AC outlet, this system can be turned ON and OFF (STANDBY mode) by pressing the POWER switch on the front panel of RX-S75 or the POWER switch on the remote control transmitter.

STANDBY mode

While the power is on, pressing the POWER switch (or the POWER switch on the remote control transmitter) switches the system to the STANDBY mode. (In this mode, the display shows only the time.) In this mode, main voltage is still present inside the system. If you want to switch off the system completely, disconnect the AC power plug from the AC outlet.

Automatic power-on function

Even when the power is off, pressing the following buttons will turn the system on, and then perform their own functions.

For Tuner operation

- TUNER on the remote control transmitter

For CD player operation

- >/■, disc selector buttons, OPEN/CLOSE on the front panel of CDC-S75
- >/■, OPEN/CLOSE on the remote control transmitter

For tape deck operation

- ◀, ▶, DECK A, DECK B on the front panel of KXW-S75
- ◀, ▶, DECK A/B on the remote control transmitter

Automatic power-off function

When the CD or TAPE input source is selected, if there is no operation and in the stop mode for about 30 minutes, the system will be turned off automatically.

SETTING THE CLOCK

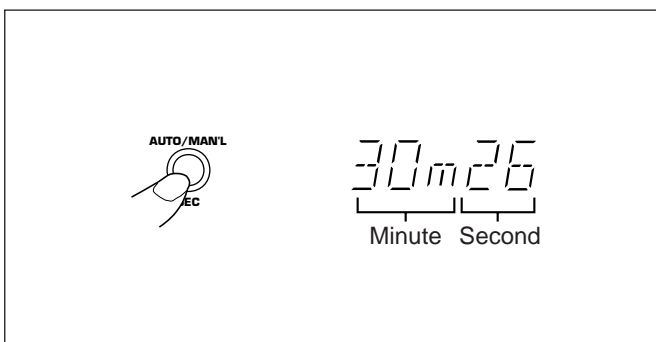
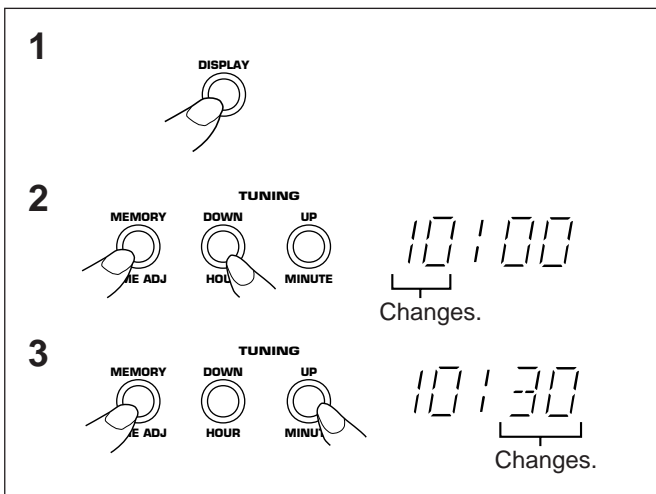

- 1** While the power is on, press the DISPLAY button to display the time. If the power is off, you can proceed to the next step.
- 2** While pressing the TIME ADJ button, press the HOUR button and set the hour.
 - * Press the HOUR button once to advance the time by 1 hour. Press and hold to advance continuously.
- 3** While pressing the TIME ADJ button, press the MINUTE button and set the minute.
 - * Press the MINUTE button once to advance the time by 1 minute. Press and hold to advance continuously.
 - * The hour setting will not advance even if minute is advanced from "59" to "00".

To display the time by "second"

While pressing the SEC button, the current time is displayed by minute and second.

To reset the second to "00"

While pressing the SEC button, press the TIME ADJ button.

- * If the current second is lower than 30, it is reset to 00.
- * If the current second is higher than 30, the minute is advanced by 1 minute and the second is reset to 00. (If the current minute is "59", in this case, the hour is also advanced by 1 hour.)

In the event of a power failure or when the AC supply lead is disconnected.

The time display will go out, however, the clock will function for about 5 minutes without power supply. So you do not have to reset the time if the AC power supply is resumed within about 5 minutes.

When the AC power supply is resumed after more than 5 minutes pass without power supply, the time display will flash on and off to indicate that the time must be reset.

Note

If this system is left for several minutes without setting the time after the AC power lead of this system is connected to the AC outlet, there may be a case that the display is turned into a demonstration mode. (This mode is virtually unnecessary for using this system.)

In this case, first turn the power on by pressing the POWER switch to cancel the mode, and then set the time.

SOUND CONTROL

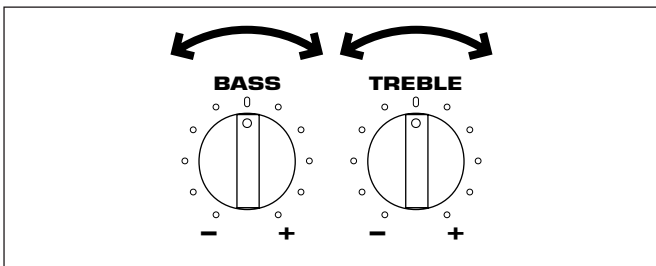
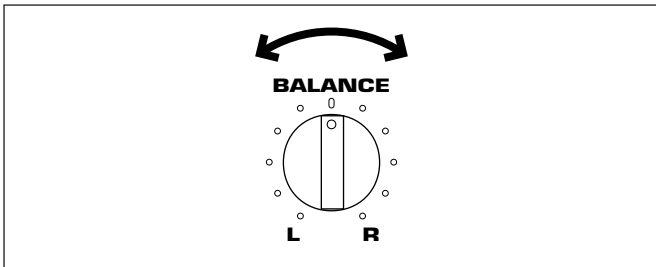
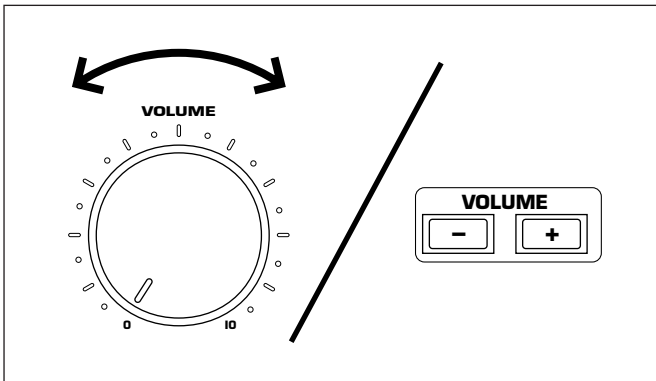

Volume

Front panel operation

Rotate the VOLUME control towards 10 to increase the volume, and towards 0 to decrease the volume.

Remote control operation

Press the VOLUME + button to increase the volume and the VOLUME - button to decrease the volume.

Balance

Adjust the balance of the output volume to the left and right speakers to compensate for sound imbalance caused from the speaker settings or the listening room condition. Turn this clockwise to emphasize the right and counterclockwise for the left.

Tone

BASS : Turn this clockwise to increase (or counterclockwise to decrease) the low frequency response.

TREBLE : Turn this clockwise to increase (or counterclockwise to decrease) the high frequency response.

DIGITAL SUPER SURROUND (DSS) PROCESSOR CONTROL <Except U.K. and Europe models>

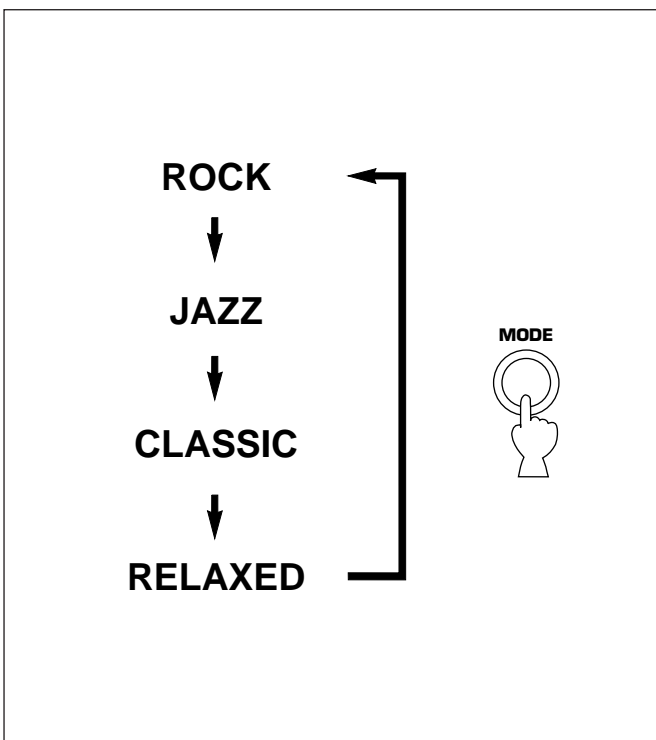

The Digital Super Surround (DSS) Processor built into this unit presents you with sound effect which simulates acoustic environments suitable for some genres of music.

This unit provides the following 4 DSS modes.

Mode	Feature
ROCK	Low frequency and high frequency of the source sound are somewhat emphasized. It is suitable for listening to rock or pop music.
JAZZ	This mode creates a sound field with much presence adding spatial effect as if music instruments are coming in front.
CLASSIC	The sound stage is expanded. It is suitable for listening to classic music, etc.
RELAXED	This mode is suitable for easy-listening music. The sound is reproduced with a soft, comfortable atmosphere.

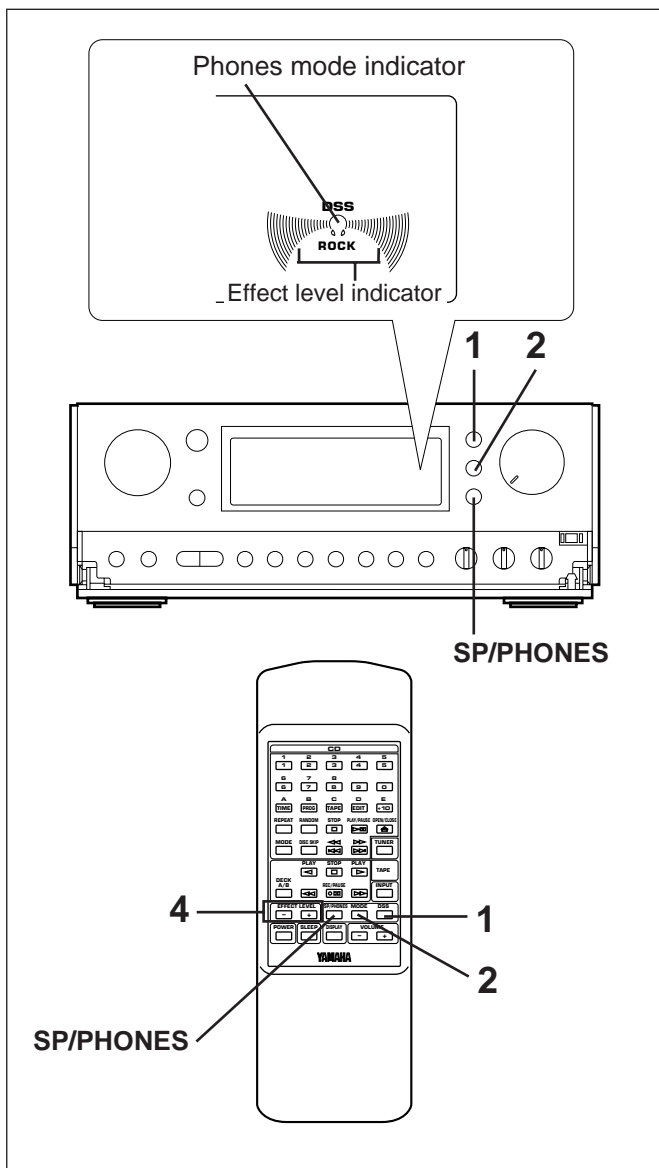

Listening to the music with the DSS

- 1 Press the DSS ON/OFF selector button so that the effect level indicator lights up on the display.
- 2 Select a desired DSS mode by pressing the DSS MODE selector button once or more until the name of the desired mode appears on the display.
- 3 Playback a source. (For source playback, refer to other sections described later.)
- 4 Adjust the level of effects by pressing the EFFECT LEVEL down (-) or up (+) button.
 - * Effect level can be checked with the effect level indicator on the display.
 - * Each of the DSS modes can be set with a different effect level.

If you will not use the DSS

Press the DSS ON/OFF selector button so that the effect level indicator on the display goes off.

When listening with headphones

Press the SP/PHONES mode selector button so that the phones mode indicator lights up on the display.

You can obtain a DSS effect suitable for the headphone listening.

If not using headphones, the SP/PHONES mode selector button should be pressed so that the phones mode indicator on the display goes off.

Note

DSS effect is also recorded along with a source. If you wish to record a source without DSS effect, turn the DSS off when recording.

COMPACT DISC PLAYER OPERATION

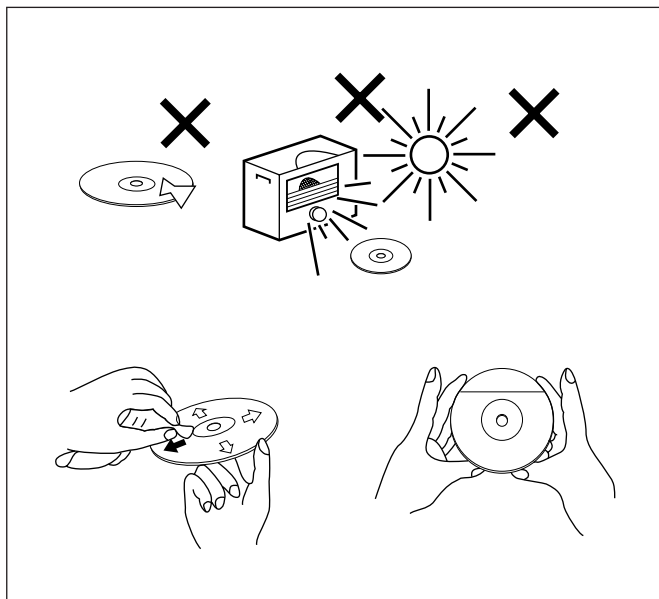

Care of compact discs

Compact discs are fairly resistant to damage, however mistracking can occur due to an accumulation of dirt on the disc surface.

Follow the guidelines below for maximum enjoyment from your CD collection and player.

- Do not write on either side of the disc, particularly the non-label side. Signals are read from the non-label side. Do not mark this surface.
- Keep your discs away from direct sunlight, heat and excessive moisture.
- Always hold the CDs by the edges. Fingerprints, dirt or water on the CDs can cause noise or mistracking. If a CD is dirty or does not play properly, clean it with a soft, dry cloth, wiping straight out from the center, along the radius.



COMPACT DISC PLAYER OPERATION

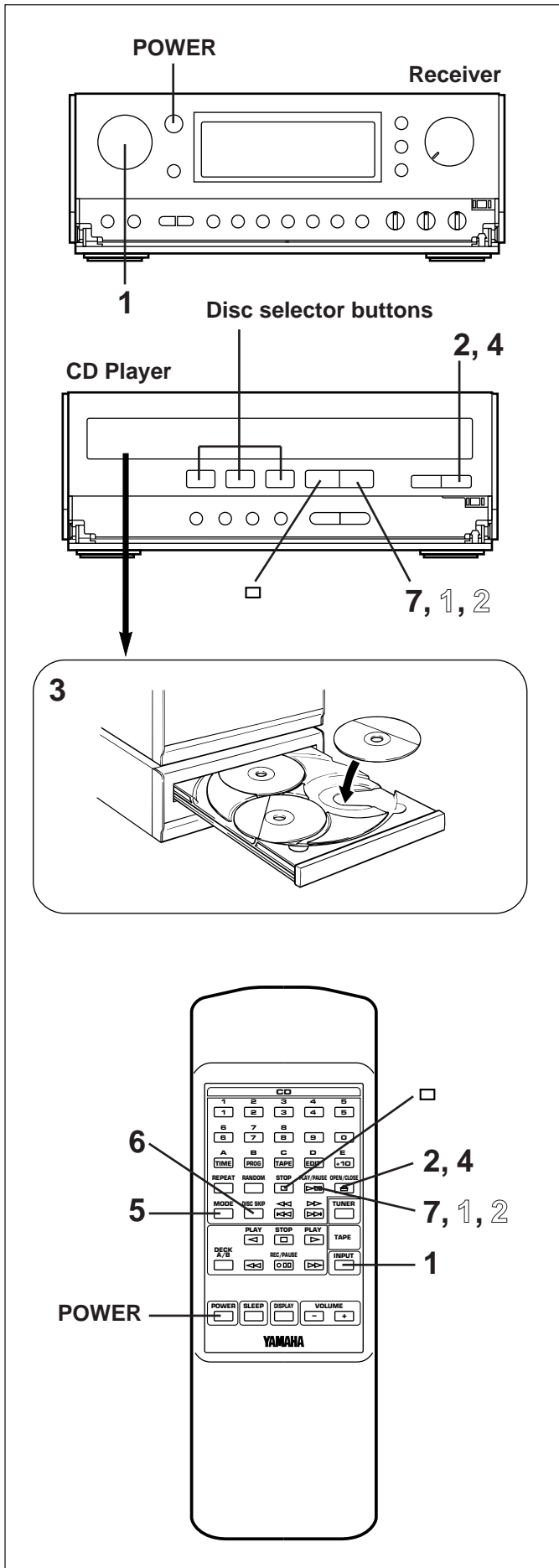

CD playback

- 1 Select the CD position with the INPUT SELECTOR control, watching the display.
- 2 Press the OPEN/CLOSE button to open the disc table.
- 3 Place discs on the trays, label side up.
 - * Up to three discs can be loaded on the trays.
 - * 8 cm (3") discs may be played without an adaptor.
- 4 Press the OPEN/CLOSE button to close the disc table.
 - * The total number of tracks and the total playing time of the disc being selected will be displayed for several seconds.
 - * The music calendar will be displayed only for the number of tracks on the disc being selected.
 - * If the compact disc contains more than 20 tracks, the "OVER" indicator will light up on the music calendar.

The disc on the tray located on top of this indicator is now being selected.

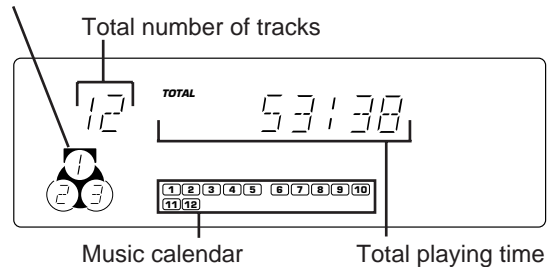

- 5 If necessary, change the disc play mode by pressing the disc play MODE selector button on the remote control transmitter while watching the display.

Single disc play mode: Only a designated disc is played back.
All disc play mode: All discs on the disc table are played back sequentially.

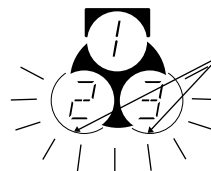

Lights up only when the all disc play mode is selected.

- 6 If necessary, select another disc by pressing the DISC SKIP button on the remote control transmitter once or more (so that the corresponding disc tray number is located on top of the disc indicator).
- 7 Press the play/pause >/|| button to start playback from track 1.
 - * The ">" indicator will appear and playback will begin. As the playback of each track on the music calendar is finished, that track number will go out.

For easier operation

Pressing the disc selector button (1, 2 or 3) will select the disc directly, and playback will begin from track 1 automatically.



COMPACT DISC PLAYER OPERATION

To interrupt playback

- 1 Press the play/pause >/|| button.
 - * The “>” indicator will flash.
- 2 Press the play/pause >/|| button to resume playback from the same point.

To stop playback

Press the stop □ button.

To switch the unit off after use

Turn the unit off by pressing the POWER switch. (The indicators will go off except for the current time display.)

Direct operation

Even when an input source other than CD player is selected, pressing the play/pause >/|| button, a disc selector button or the RANDOM play button, or pressing the front edge of the disc table gently will start playback directly. In this case, if the tape deck is playing back a tape, it will be stopped automatically.

* These ways of playback can also be used to close the disc table. If the table is closed in these ways, playback will begin automatically, however, the display will not show the total number of tracks and the total playing time of the disc to be played.

PLAYXCHANGE

During playback, you can open the disc table by pressing the PLAYXCHANGE button without interrupting disc playback. However, in this case, pressing the DISC SKIP button or a disc selector button has no effect.

Precautions

- If TV or radio interference occurs during CD player operation, move the unit away from the TV or radio.
- Subjecting the unit to shock or vibration can cause mistracking.
- Playing some compact discs at high volume can cause mistracking. In this case, listen at lower volume.
- Do not pull open the disc table forcibly with your hands.
- Do not push the disc table while it is moving.
- If the power fails while the table is open, wait until the power supply returns or gently push the table manually to close it.
- The temperature range for playing compact discs is recommended to be 5°C (41°F) – 35°C (95°F).

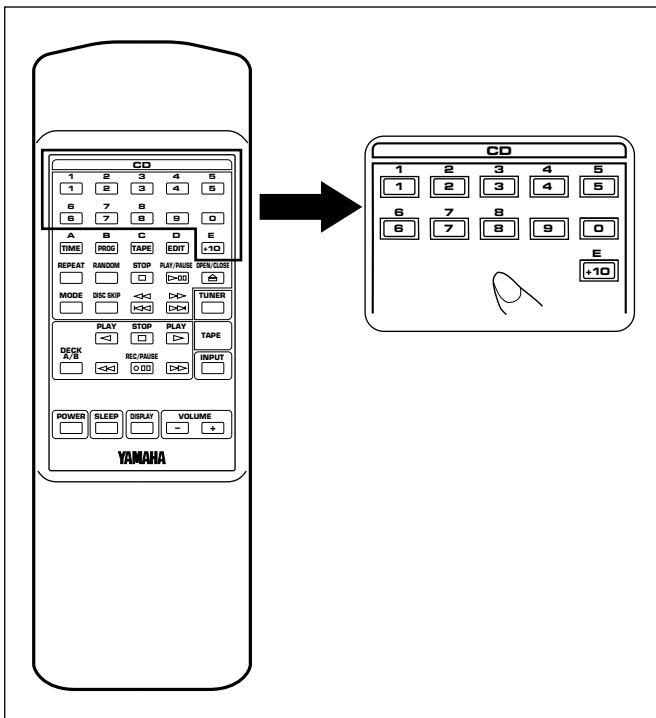

Direct-selection play

By using the track number input buttons on the remote control transmitter, any track you wish to listen to can be played directly.

Use the track number input buttons to select the desired track number. Play will begin automatically.

A. For example, to choose selection 5

Press the “5” button.

B. For example, to choose selection 12

- (1) Press the “+10” button.
- (2) Within 3 seconds, press “2” button.

C. For example, to choose selection 20

- (1) Press the “+10” button.
- (2) Within 3 seconds, press the “+10” button again.
- (3) Within 3 seconds, press the “0” button.

Note

If you select a track number higher than the number of tracks on the disc, play will begin from the last track on the disc .



COMPACT DISC PLAYER OPERATION

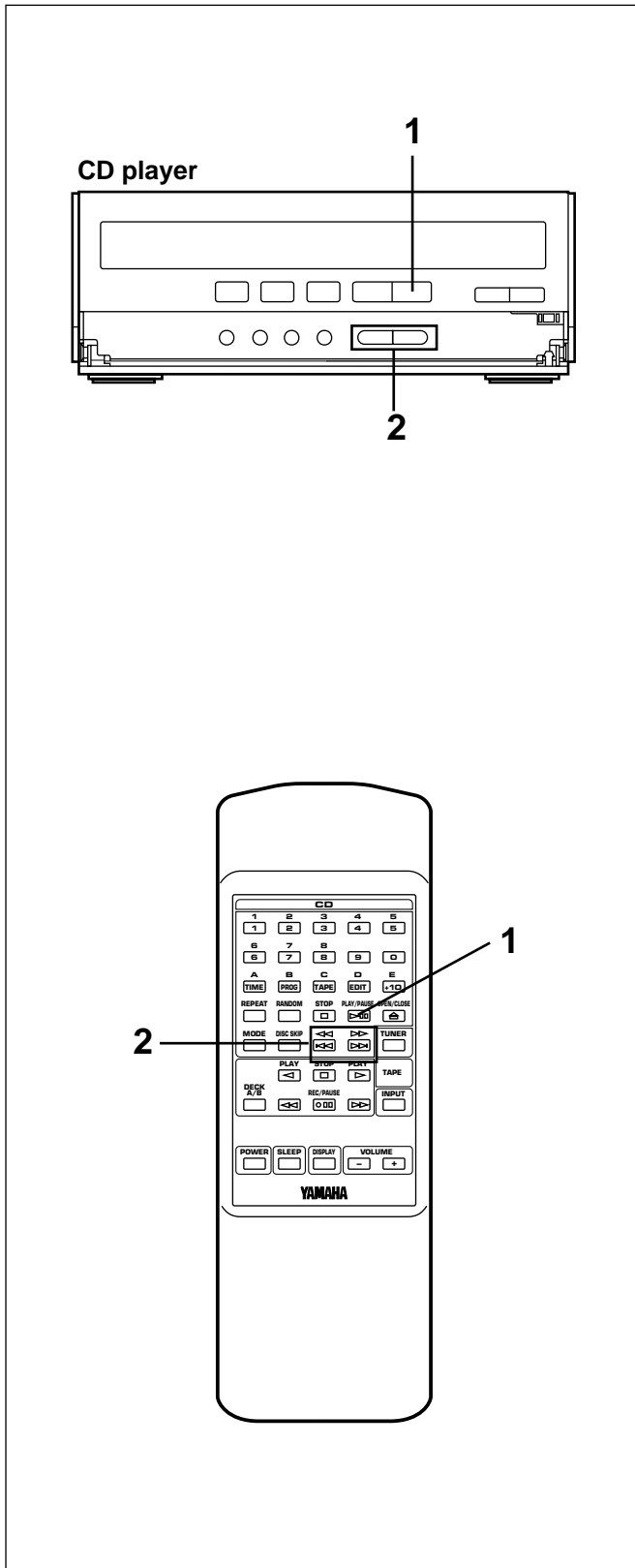

“Skip search” and “Manual search” are performed using the same buttons.

Skip search

The beginning of any track can be found automatically.

- 1 Select a disc and begin playback.
- 2 Press the $\triangleright\triangleright$ button to advance or $\triangleleft\triangleleft$ button to reverse through the disc. Press once for each track to be advanced or reversed.
 - Press $\triangleright\triangleright$ once to advance to the track following the one now playing back.
 - Press $\triangleleft\triangleleft$ once to return to the start of the track now playing back.
 - Press $\triangleleft\triangleleft$ twice to return to the track before the track now playing back.

Notes

- This function can also be performed while the unit is stopped. Press the play/pause \triangleright/\square button when your desired track number appears in the track number display. Playback will begin from the beginning of the track.
- This function will be performed forward or backward from any point on the disc. However, it will not move forward during playback of the final track.

Manual search

- 1 Begin playback.
- 2 Press and hold the $\triangleright\triangleright$ button to advance play rapidly, and the $\triangleleft\triangleleft$ button to reverse play rapidly.
 - * The sound can be heard (although slightly garbled) during manual search in either direction. This is convenient for reviewing the contents quickly.

Note

Manual search can also be performed while playback is paused, though no sound will be heard.



COMPACT DISC PLAYER OPERATION

Program play

You can program up to 20 tracks in any desired order.

- 1** Load discs and close the disc table.
- 2** When in the stop mode, press the PROG button to prepare for programming.
 - * "PROGRAM" and "P-01" will light up on the display, and all track numbers on the selected disc begin flashing.
- 3** If necessary, select a desired disc by pressing the DISC SKIP button.
- 4** Use the track number input buttons to select the desired track number.
 - * The selected track number and the total play time of the programmed tracks will light up on the display, and soon it is replaced by the display of the next playback order. Programmed track numbers on the selected disc will stop flashing and light up on the music calendar.
 - * Pressing the TIME button displays the total play time of the programmed tracks for about 1 second, and then it is replaced by the display of the next playback order.
- * **For example, to choose selection 12**
 - (1) Press the "+10" button.
 - (2) Press the "2" button.
- 5** Repeat steps 3 and 4 for any other track. Up to 20 tracks can be programmed.
- 6** Press the play/pause >/⏸ button to start playback of programmed tracks.

Notes

- It is also possible to program a sequence of tracks while looking at the list of tracks on the surface of the disc before closing the disc table.
- During playback or pause, programming is not possible.
- If the total time of the programmed tracks reaches 100 minutes or more, only the last two-digits will be displayed for the three-digit number.
- The total time of the programmed tracks will not be displayed, if a track number higher than 19 is programmed.
- Skip search can be performed during playing back, but only within the range of the programmed tracks.
- Manual search can be performed during playing back to search through all tracks, including unprogrammed tracks.
- If programs are made selecting tracks from more than one disc, pressing the PLAYXCHANGE button is useless during program play.

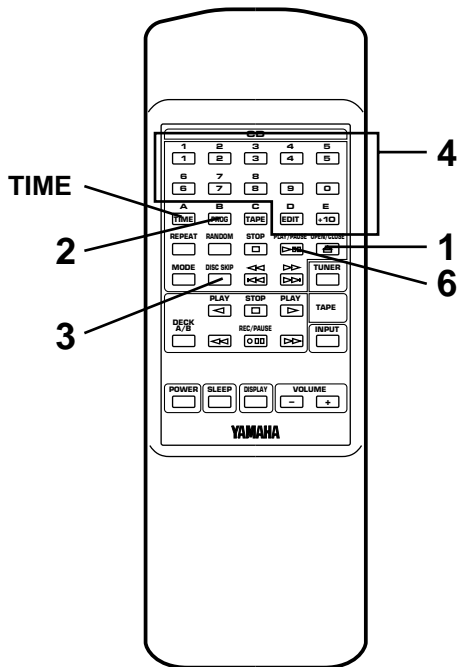
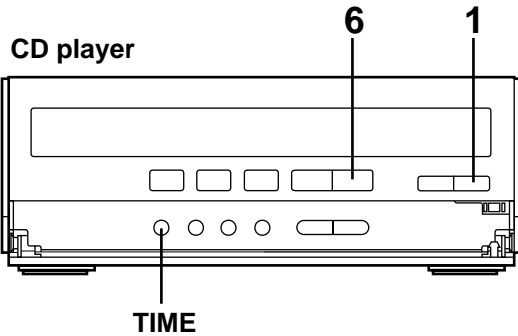

Display information during programming

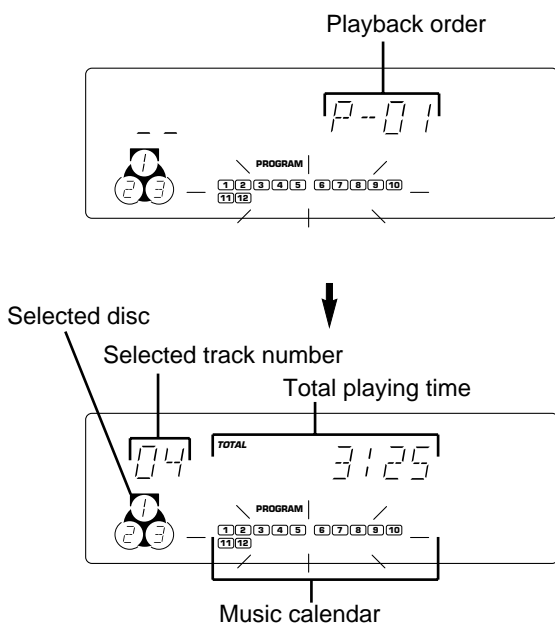



COMPACT DISC PLAYER OPERATION

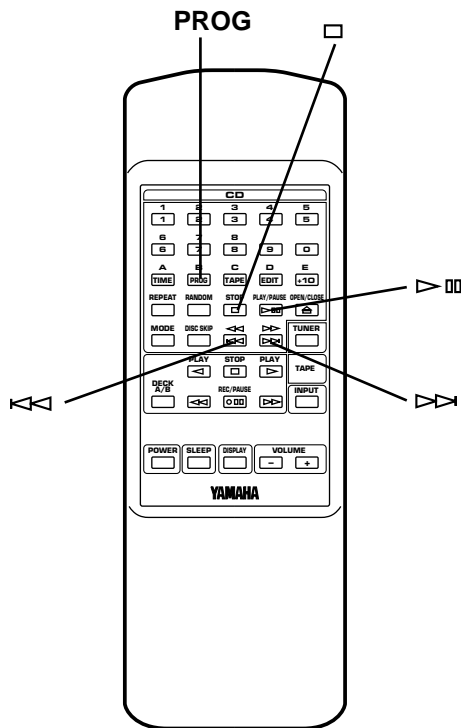
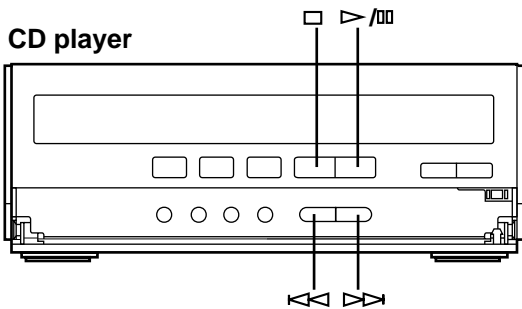

To stop program play

- Press the stop \square button. The first programmed track number will be displayed.
- To resume playback, press the play/pause \triangleright/\parallel button. Playback will begin from the beginning of the program.

To cancel a programmed sequence

There are several methods as described below.

- Press the stop \square button while the unit is stopped.
- Open the disc table.
- Switch off the power.

To check program data

1. If during playing back, press the stop \square button.
2. Press the PROG button.
3. Each time the SKIP $\triangleright\triangleright$ button is pressed, the track numbers and sequential order of the programmed tracks can be checked one after another. The display of the track number can be returned (sequentially in reverse order) by pressing the SKIP $\triangleleft\triangleleft$ button.

To correct program data

1. Follow the procedure described in "To check program data".
2. Display the track number to be corrected by pressing the SKIP button.
3. Press a track number input button to select a track to replace the one displayed. The previously programmed track will be cleared from the memory and the new one will be programmed.
4. After the correction has been completed, press the PROG button or play/pause \triangleright/\parallel button once again.



COMPACT DISC PLAYER OPERATION

Repeat play

All discs, an entire disc, a single track or a programmed sequence can be continuously repeated.

- 1 While watching the display, press the REPEAT button once or more to select a desired repeat play mode (S REPEAT or F REPEAT).
- 2 Press the play/pause >/⏸ button.

Repeat play modes

SINGLE REPEAT (S REPEAT)

A single track is played back repeatedly.

* This is also available in the program play mode and the random play mode. (If the repeat play mode is switched off, the program play mode or the random play mode will be resumed.)

FULL REPEAT (F REPEAT)

When the unit is in the single disc play mode:

A designated disc is played back repeatedly.

* In the random play mode, the selected disc is repeatedly played back, but the order of tracks is different every time.

When the unit is in the all disc play mode:

All discs on the disc table are played back repeatedly.

* In the random play mode, the random play is performed among all discs and repeated with a different order of tracks every time.

Note

In the program play mode, a sequence of programmed tracks is played back repeatedly.

To cancel the repeat play

Press the REPEAT button once or more so that the (S, F) REPEAT indicator goes out.

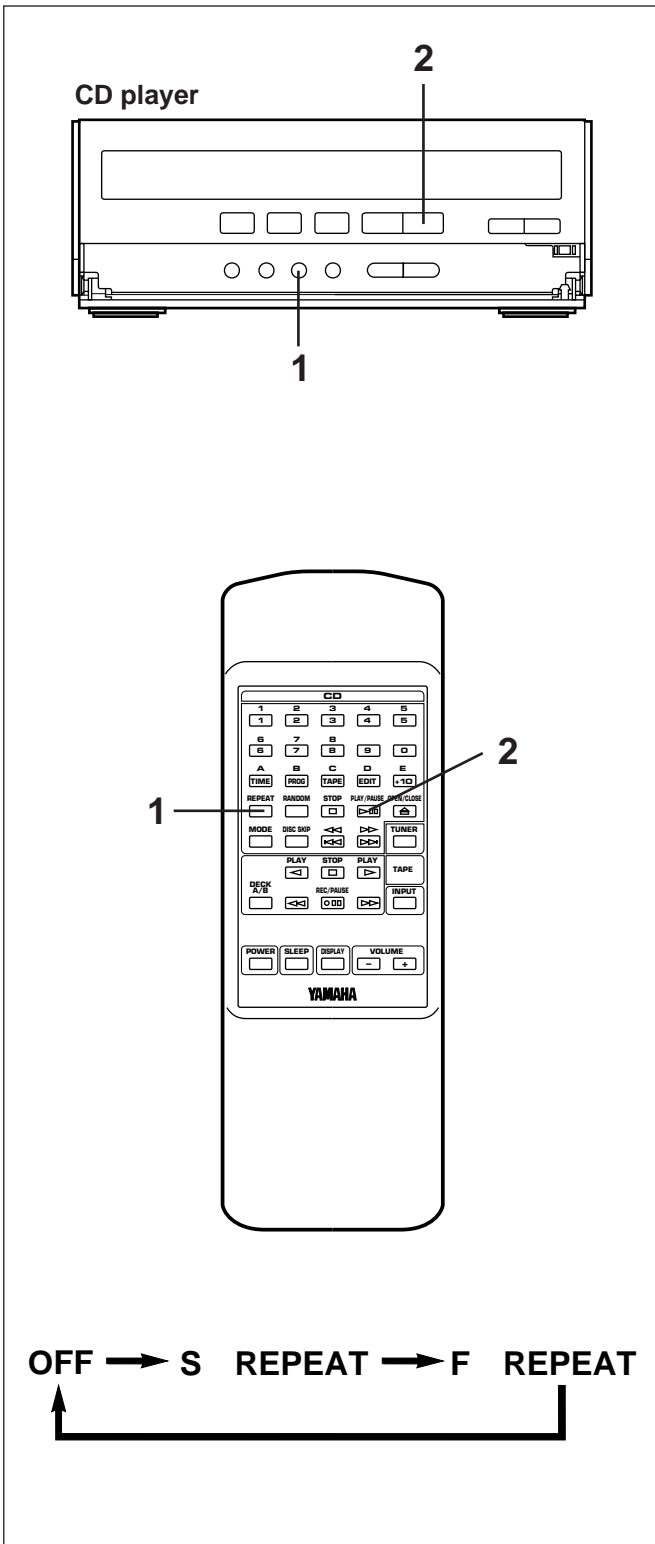



COMPACT DISC PLAYER OPERATION

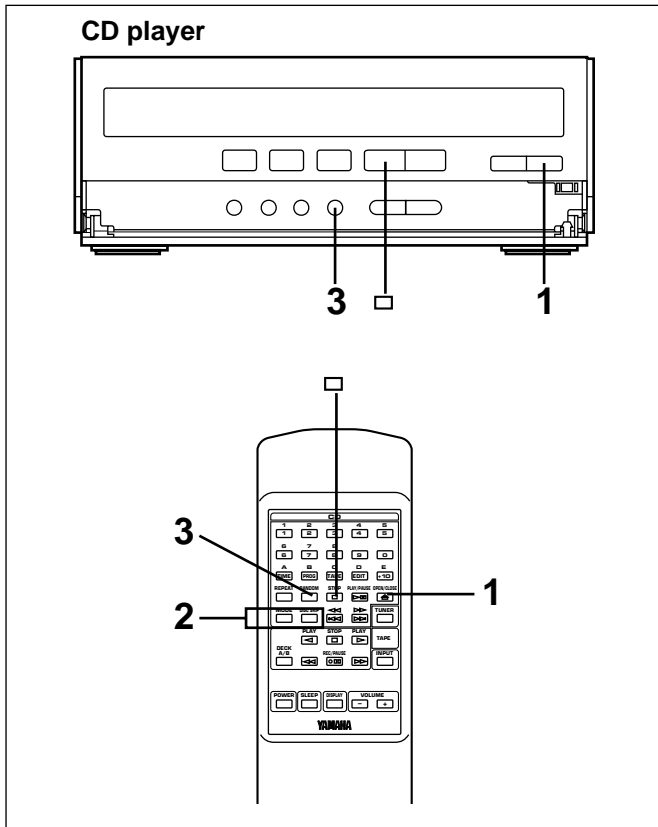

Random play

Tracks on a selected disc or all discs on the disc table can be played back in a random order.

- 1 Load discs and close the disc table.
- 2 If necessary, switch the disc play mode by pressing the disc play MODE selector button.
 - * If the single disc play mode is selected, select a desired disc by pressing the DISC SKIP button.
- 3 Press the RANDOM button to begin random play.
 - * The "RANDOM" indicator will light up.

To cancel the random play

Press the stop button, or press the RANDOM button again. The "RANDOM" indicator will go out.

Note

This feature will not function during programming, or during program play.

Switching the time display

Each time the TIME button is pressed, the display will change as described below.

[Example]

When the second track is being played back (Refer to the illustration on the left.)

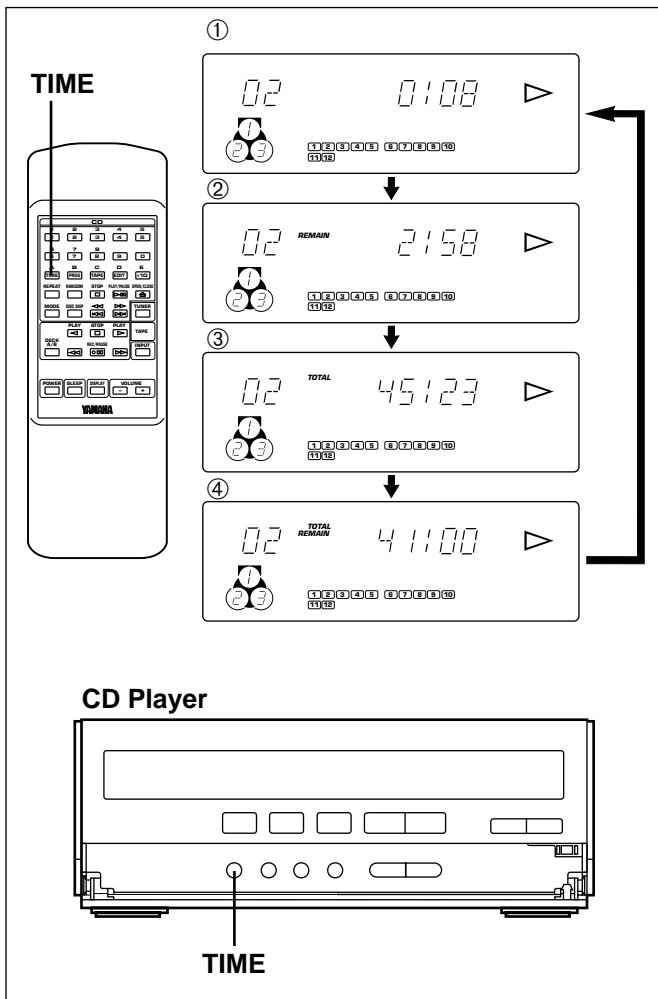

- 1 The elapsed play time for the track now playing back will be displayed.
 - * 8 seconds have passed since the beginning of the second track.
- 2 The remaining play time for the current track will be displayed.
 - * 2 minutes and 58 seconds remain till the end of the second track.
- 3 The total play time of the disc will be displayed. (If the unit is in the program play mode, the total play time of the programmed tracks will be displayed.)
- 4 The total remaining play time from the point being played at that time will be displayed.
 - * 41 minutes remain till the end of the disc.

Notes

- During random play, the total remaining play time on the disc will not be displayed.
- The remaining play time will not be displayed for track number 20 or higher.
- If track number 20 or higher is programmed, during the program play, the total play time and the total remaining play time will not be displayed.

TUNING OPERATION

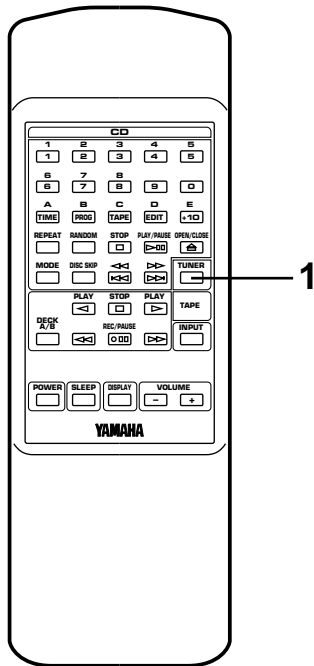
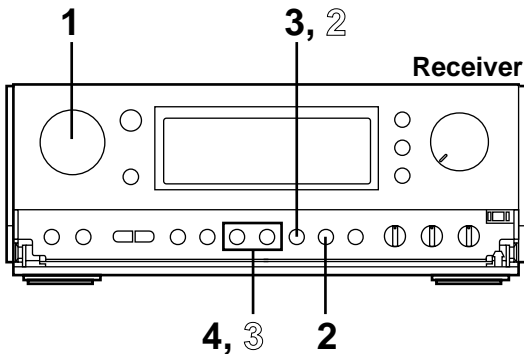

Normally, if station signals are strong and there is no interference, quick automatic-search tuning (Automatic tuning) is possible. However, if signals of the station you want to select are weak, you must tune to it manually (Manual tuning).

Automatic tuning

- 1 Select the TUNER position with the INPUT SELECTOR control, watching the display.
- 2 Select the reception band [FM or AM (MW or LW)] by pressing the BAND button while watching the display.
- 3 Press the AUTO/MAN'L button so that "AUTO TUNING" appears on the display.
(In this mode, stations are received in stereo or monaural automatically.)
- 4 Press the TUNING UP button to tune to a higher frequency, or press the TUNING DOWN button to tune to a lower frequency.
(When tuned to a station, "TUNED" will light up on the display.)
- 5 If the station where tuning search stopped is not the desired one, follow step 4 again.

- * If the tuning search does not stop at the desired station, change to the Manual tuning method as described below.
- * STEREO indicator will light up when an FM stereo broadcast with sufficient signal strength is received.

Manual tuning

- 1 Follow steps 1 and 2 of the Automatic tuning method.
- 2 Press the AUTO/MAN'L button so that "AUTO TUNING" disappears from the display.
(In this mode, stations are received in monaural.)
- 3 Press and hold the TUNING UP button to tune to a higher frequency, or press and hold the TUNING DOWN button to tune to a lower frequency.
Release it just before reaching the desired frequency, and then press it repeatedly until the desired frequency appears.
(When tuned to a station, "TUNED" will light up on the display.)

Note

If you tune to an FM station manually, it is received in monaural automatically to increase the signal quality.

"AM" is for U.S.A., Canada, Australia, Singapore and General models.

"MW/LW" is for U.K. and Europe models.



TUNING OPERATION

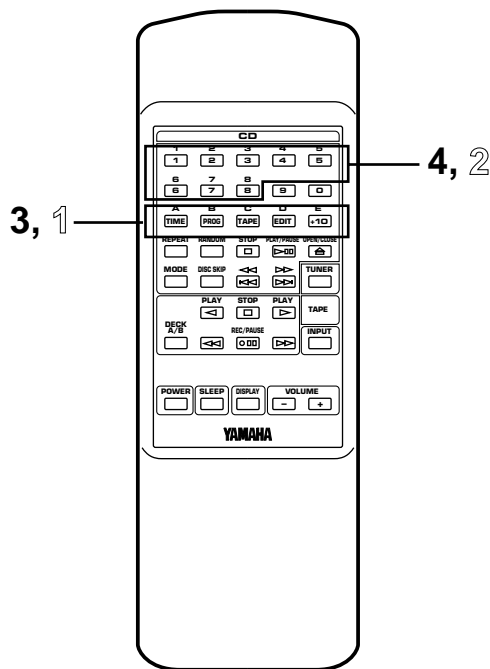
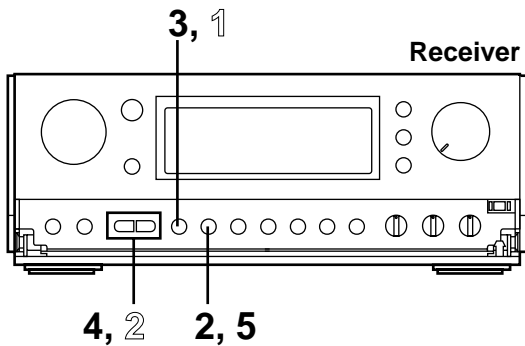

Preset tuning

This unit can store station frequencies selected by tuning operation. With this function, you can select any desired station by only calling the corresponding preset station number. Up to 40 stations (8 stations x 5 areas) can be stored.

To store stations

(Example: To store a station to A1)

- 1 Tune to a desired station.
(Refer to the previous page for tuning procedure.)
- 2 Press the MEMORY button.
* "MEMORY" and "P" will flash on the display for about 5 seconds.
- 3 Select a desired area (A – E) by pressing the A/B/C/D/E button while watching the display, before the MEMORY indicator goes out.
(In this case, select area A)
- 4 Select a preset station number by pressing the TUNER PRESET DOWN or UP button repeatedly before the MEMORY indicator goes out.
(In this case, select "1".)
- 5 Within about 5 seconds, press the MEMORY button again.

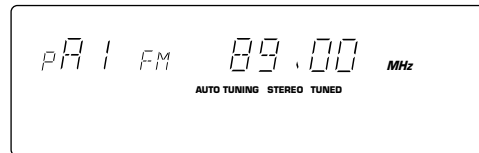

Shows the displayed station has been programmed to A1.

- * In the same way, program other stations to A2, A3 ... A8.
- * You can program more stations to the preset station numbers on other areas in the same way by selecting other areas in step 3.

To recall a preset station

- 1 Select the area of preset station numbers by pressing the A/B/C/D/E button.
- 2 Select the desired preset station number by pressing the TUNER PRESET DOWN or UP button repeatedly.

Notes

- A new setting can be programmed in place of the former one.
- For presets the setting of the AUTO/MAN'L button is stored along with the station frequency.

For easier operation

By using the preset station number buttons and the A,B,C,D,E selector buttons on the remote control transmitter, a preset station number and an area can be selected directly.

TUNING OPERATION

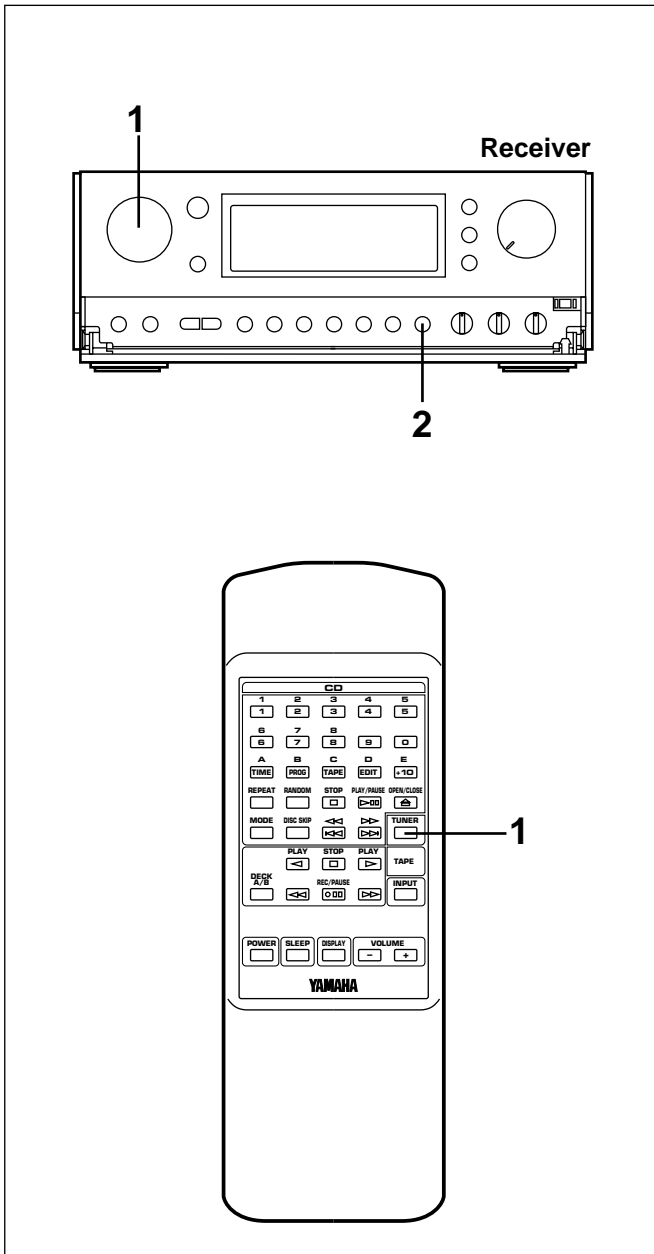

Automatic preset tuning

You can also make use of an automatic preset tuning function. By this function, this unit performs automatic tuning and stores stations with strong signals sequentially. Up to 40 stations are stored automatically in the same way as in the manual preset tuning method on the previous page.

- 1 Select the TUNER position with the INPUT SELECTOR control, watching the display.
- 2 Press and hold the AUTO MEMO button for about 2 seconds.
 - * The MEMORY and AUTO TUNING indicators will flash.

This unit performs automatic tuning and received stations are programmed to A1, A2 ... A8 sequentially.

When the automatic preset tuning is completed

The display shows the frequencies of the first preset station (stored to A1).

Check the contents and the number of preset stations by following the procedure of the section "To recall a preset station" on the previous page.

To recall a preset station

Simply follow the procedure of the section "To recall a preset station" on the previous page.

Notes

- The automatic preset tuning search will be performed through all frequencies until 40 stations are stored. If the number of received stations is less than 40, the search will stop after searching all frequencies.
- **<U.K. and Europe models only>**
The unit is originally set so that only RDS stations are programmed onto the area for FM stations by this operation.
However, you can change the setting so that the unit can program not only RDS stations but also other FM stations. (Refer to page 25 for details.)
- With this function, only stations with sufficient signal strength are stored automatically. If the station you want to program is weak in signal strength, tune to it in monaural manually and program it by following the procedure of the section "To store stations" on the previous page.
- You can replace a preset station by another FM or AM (MW or LW) station manually by simply following the procedure of the section "To store stations" on the previous page.

Fundamental rules of internal automatic preset tuning operation

Basically, FM stations are programmed onto area A, B and C, and AM stations are programmed onto area D and E (MW stations are onto D and LW stations are onto E) in that order automatically.

- * If, for example, the number of received FM stations is not enough to fill up three areas (A, B and C), AM (MW or LW) stations are programmed closely from the preceding empty areas. In such a case, AM (MW) stations are programmed from area B or C (and LW stations are from area C or D.)
- * Moreover, one area is programmed with stations of the same band only. If, for example, the last FM station is programmed to B4, B5–B8 will be programmed with no station, and AM (MW) stations are programmed from area C.

Memory back-up

The memory back-up circuit prevents the programmed data from being lost even if the AC supply lead is disconnected from the AC outlet or the power is cut due to temporary power failure. If, however, the power is cut for more than one week, the memory may be erased. If so, it can be re-programmed by simply following the Preset tuning steps.



RECEIVING RDS STATIONS <U.K. and Europe models only>

RDS (Radio Data System) is a data transmission system gradually being introduced by FM stations in many countries. Stations using this system transmit an inaudible stream of data in addition to the normal radio signal. RDS data contains various information, such as AF (Alternative Frequencies for the same program station),

PI (Program Identification), PS (Program Service name), PTY (Program Type), RT (Radio Text), CT (Clock Time), etc. RDS function is carried out among the network stations. * This unit utilizes PS, PTY, RT and CT to receive RDS broadcast stations.

Displaying RDS data

This unit can be turned into the following four modes to display RDS data.

PS (Program Service name) mode:

Displays the name of the RDS station now being received instead of the frequency. **BBC R3**

PTY (Program Type) mode:

Displays the type of the program on the RDS station now being received. There are 15 program types to classify RDS stations as follows.

NEWS

News:
Short accounts of facts, events and publicly expressed views, reportage and actuality.

AFFAIRS

Current affairs:
Topical program expanding or enlarging upon the news, generally in different presentation style or concept, including documentary debate, or analysis

INFO

Information:
Program whose purpose is to impart advice in the widest sense, including meteorological reports and forecasts, consumer affairs, medical help, etc.

SPORT

Sport:
Program concerned with any aspect of sport.

EDUCATE

Education:
Program intended primarily to educate, of which the formal element is fundamental.

DRAMA

Drama:
All radio plays and serials.

CULTURE

Culture:
Programs concerned with any aspect of national or regional culture, including religious affairs, philosophy, social science, language, theatre, etc.

SCIENCE

Science:
Programs about the natural sciences and technology.

RT (Radio Text) mode:

Displays information about the program (such as title of the song, name of the singer, etc.) on the RDS station now being received.

CT (Clock Time) mode:

Displays current time. This signal comes from the RDS station now being received. Time of the built-in clock can be automatically corrected on the basis of this signal.

VARIED

Varied:
Used for mainly speech-based programs usually of light-entertainment nature, not covered by above categories. Examples are: quizzes, panel games, personality interviews, comedy and satire.

POP M

Pop:
Commercial music, which would generally be considered to be of current popular appeal, often featuring in current or recent record sales charts.

ROCK M

Rock:
Contemporary modern music, usually written and performed by young musicians.

M.O.R. M

M.O.R.:
(Middle of the Road Music). Common term to describe music considered to be "easy-listening", as opposed to Pop, Rock or Classical. Music in this category is often but not always, vocal, and usually of short duration (<5 min.)

LIGHT M

Light classics:
Classical Musical for general, rather than specialist appreciation. Examples of music in this category are instrumental music, and vocal or choral works.

CLASSICS

Serious classics:
Performances of major orchestral works, symphonies, chamber music etc., and including Grand Opera.

OTHER M

Other music:
Musical styles not fitting into any of the above categories. Particularly used for specialist music, of which Jazz, Rhythm & Blues, Folk, Country, and Reggae are examples.

RECEIVING RDS STATIONS <U.K. and Europe models only>
To turn the unit into the RDS mode

Press the RDS MODE selector button. If the station now being received is an RDS station, whenever pressed, the mode changes into the PS mode, PTY mode, RT mode, CT mode and returns to usual mode in turn.

- * If the station is not an RDS station, pressing the RDS MODE selector button displays "NO RDS" on the display, and then it returns to the frequency display mode.
- * When an RDS station is received, the display is automatically turned into the PS mode. Do not press the RDS MODE selector button until the display is turned into the PS mode. If the button is pressed before the display mode is changed, it may occur that "NO PS" appears on the display. This is because the unit has not received all of the RDS data on the station yet.

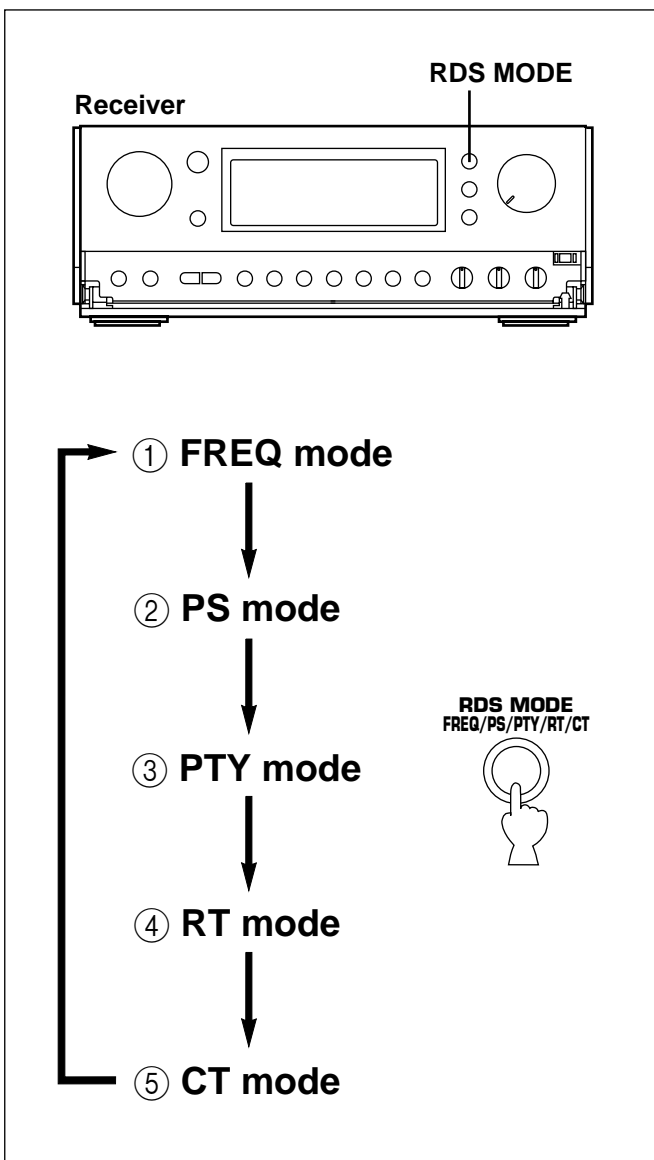

- ① **FREQ (usual) mode**
The frequency of the station being received is displayed.
- ② **PS (Program Service name) mode**
The name of the station being received is displayed. "PS WAIT" may flash while the unit is receiving the data.
If the station does not employ the PS data service, "NO PS" lights up on the display for about 2 seconds and then returns to usual mode.
- ③ **PTY (Program Type) mode**
The type of the program on the station being received is displayed. If the RDS station does not employ the PTY data service, "NO PTY" lights up on the display for about 2 seconds and then returns to usual mode. If the station has PS data, after that, it turns into the PS mode.
In this mode, you can make this unit search for a station which is broadcasting a program of your desired program type. For details, refer to the next page.
- ④ **RT (Radio Text) mode**
Information about the program on the station being received is displayed. Information is displayed by a maximum of 64 Roman Alphabets including umlaut sign. If other characters are used on the RT data, they are displayed with blank spaces.
"RT WAIT" may flash while the unit is receiving the data.
If the RDS station does not employ the RT data service, "NO RT" lights up on the display for about 2 seconds and then returns to usual mode. If the station has PS data, after that, it turns into the PS mode.
- ⑤ **CT (Clock Time) mode**
Current time is displayed in the following form. The CT data from the station being received changes every minute.

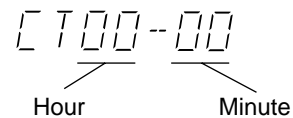

This unit corrects time of the built-in clock by synchronizing it with the CT data. (This function can also be canceled, if so desired. Refer to page 25 for details.)
"CT WAIT" may flash while the unit is receiving the data. If the data is accidentally cut off, "CT WAIT" may flash and then turn into "NO CT".
If the RDS station does not employ the CT data service, "NO CT" lights up on the display for about 2 seconds and then returns to usual mode. If the station has PS data, after that, it turns into the PS mode.

Note

RDS data service cannot be utilized by this unit if the received signal is not strong enough. Especially, the RT (Radio Text mode) needs much data to be received, so it may occur that RT mode cannot be displayed even if other RDS modes (PS, PTY, etc.) are displayed.



RECEIVING RDS STATIONS <U.K. and Europe models only>

Notes

- There may be a case that RDS data reception is not possible due to poor reception conditions. If so, press the AUTO/MAN'L button so that "AUTO TUNING" goes off from the display. Though the reception mode is changed to monaural by this operation, when you change the display to an RDS mode, RDS data may be displayed.

- If the signal strength gets weakened by external interference during receiving an RDS station, the RDS data service may be cut off suddenly and turn into the frequency display mode.

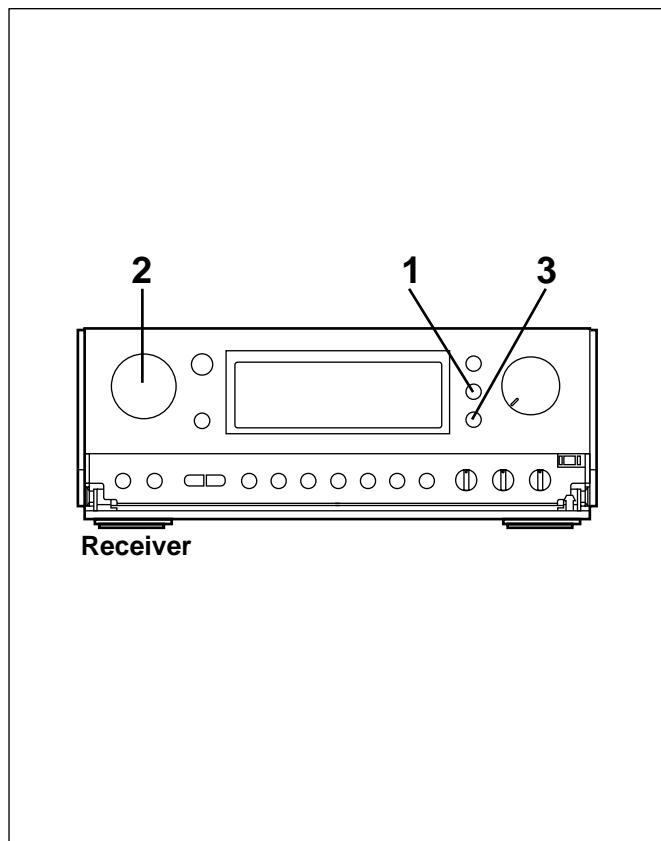

Calling a preset RDS station by the program type (PTY SEEK)

By designating a program type, the unit automatically searches all preset FM stations for an RDS station which broadcasts a program of that program type.

- * There are 15 program types to classify RDS stations. For details, refer to page 22.

- 1** Turn the unit into the PTY SEEK mode by pressing the PTY SEEK MODE button.
 - * The name of the program type of the station now being received or "NEWS" flashes on the display.
- 2** Select the desired program type with the PTY SELECTOR.
 - * If there is no operation for about 20 seconds, this mode is canceled and turns into the frequency display. If the station has PS data, after that, it turns into the PS mode.
- 3** Press the PTY SEEK START button.

The unit begins searching all preset FM stations.

 - * "PTY H" (abbrev. of PTY HOLD) lights up on the display.
 - * The preset number indicator, the name of the program type and "AUTO TUNING" flash. The preset number changes rapidly in sequence.

- If a station which broadcasts a program of the program type is found, the unit stops at the station and turns into the frequency display. If the station has PS data, after that, it turns into the PS mode.
- If the called station is not the desired one, press the PTY SEEK START button once more before "PTY H" goes out from the display.

The unit begins searching for another station which broadcasts a program of the same program type.
- If no station is found, "NO PTY" appears and then returns to frequency display. If the station has PS data, after that, it turns into the PS mode.
 - * If the PTY SEEK START button is pressed once more during searching, this mode is canceled and turns into the frequency display. If the station has PS data, after that, it turns into the PS mode.

To cancel this function

If the PTY SEEK MODE button is pressed once more, the PTY SEEK mode is canceled and turns into the frequency display. If the station has PS data, after that, it turns into the PS mode.

Other functions which make use of RDS data service

This unit has the following functions which make use of RDS data service. These are originally in operation [ON]. However, you can cancel these functions [OFF], if so desired.

① ON (OFF) CT > CLOCK

This unit corrects the time of the built-in clock automatically by synchronizing it with the CT data on the RDS station being received.

- * If you receive an RDS station of some other country, the built-in clock is synchronized with the time setting of the country.
- * If the built-in clock is not yet set for current time or reset due to a power failure etc., it will be set for the time of the CT data automatically, whether this setting is ON or OFF.

② ON (OFF) LOCAL > CT

If the RDS station being received employs the local time (summer time etc.) data service, its time is displayed in the CT mode.

- * If the setting of function ① is "ON", the built-in clock is synchronized with the local time data.

③ ON (OFF) A. M. > RDS

Only RDS stations are programmed onto the area for FM stations by the automatic preset tuning operation when the setting is ON.

- (See page 21 for the operating procedure.)
- If you switch this function OFF, not only RDS stations but also other FM stations are programmed along with MW and LW stations by the automatic preset tuning operation.

To switch these functions on and off

- 1** Select the FM band by pressing the BAND button, watching the display.
- 2** Press the DISPLAY button to display the current time.
- 3** Press the RDS MODE selector button.
The title of function ① "ON CT > CLOCK" is displayed.
- 4** Select the title of function whose setting you want to switch by pressing the PTY SEEK MODE button once or more.
- 5** Switch the function ON or OFF by pressing the PTY SEEK START button, watching the display.
- 6** Press the RDS MODE selector button again to restore the frequency display mode.
* If the station has PS data, after that, it turns into the PS mode.

Notes

- Once the setting is changed, it will be stored until it is changed again by the above operation.
- During the operation, if there is no operation for about 20 seconds, this mode is canceled and turns into the frequency display.
If the station has PS data, after that, it turns into the PS mode.

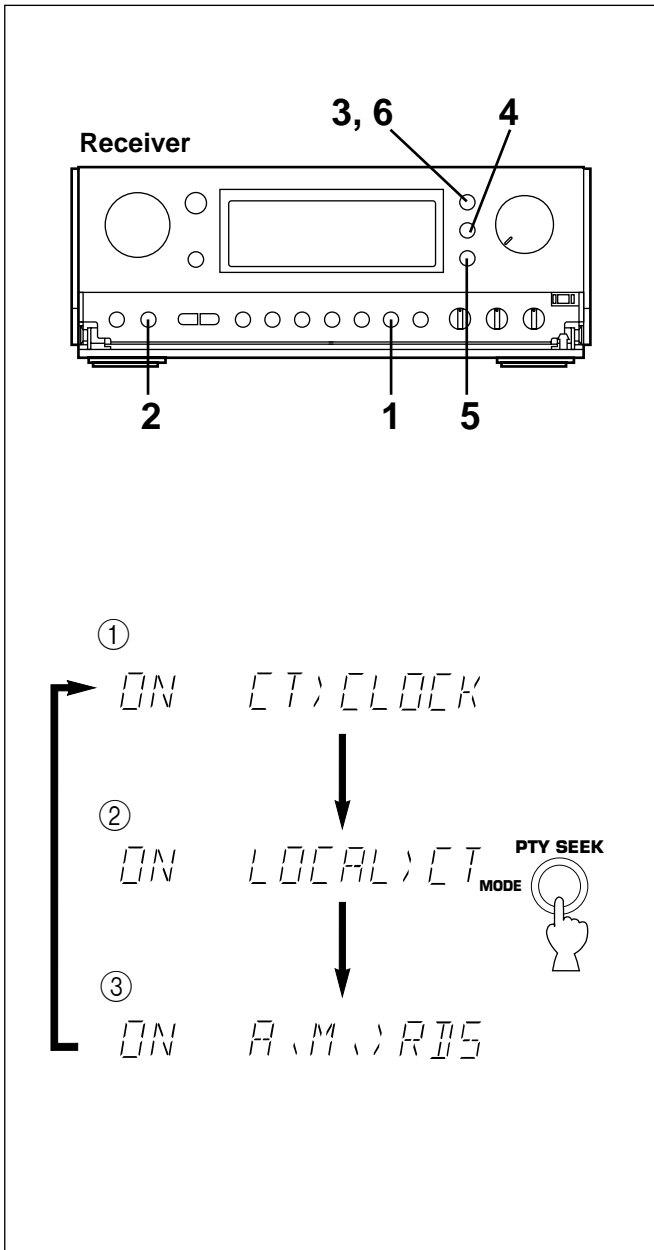



TAPE DECK OPERATION

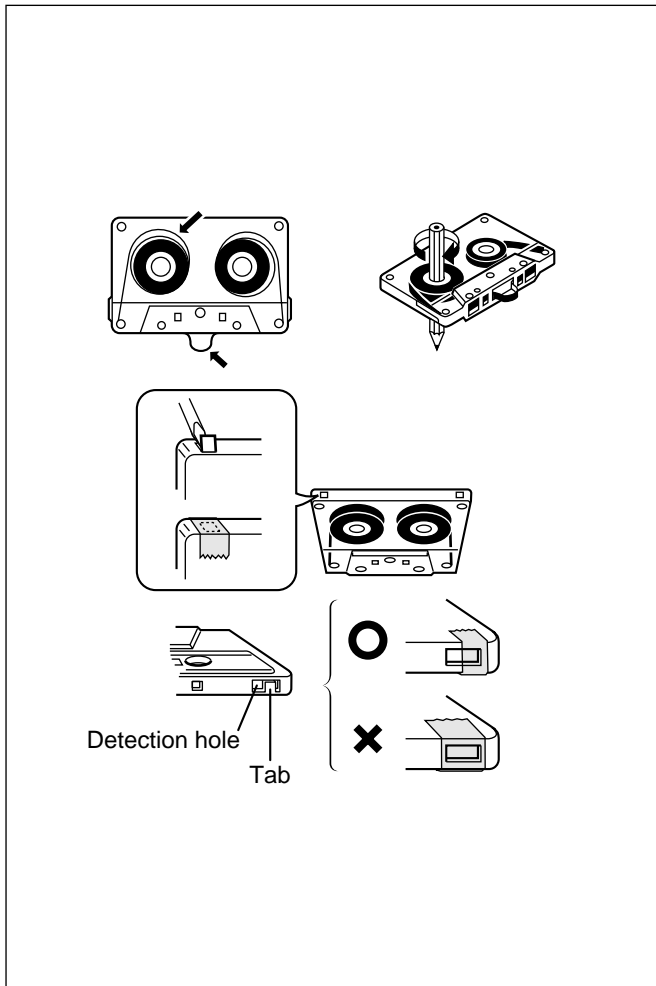

General information

- Do not use C-120 tapes or poor-quality tapes, since they can cause malfunctions.
- Before loading a tape into the cassette compartment, tighten the tape slack with a pen or pencil.
- Tapes have removable tabs which prevent accidental recording or erasing from taking place. Removing the tab on the top left protects the side facing you from erasure. Cover the tab holes with adhesive tape to erase or record again.
- This deck is a Double Cassette Deck with Automatic Reverse Function.
DECK A: Playback only.
DECK B: Playback or recording.
- This deck features an auto tape selector. Just load the tape, and the tape formula being used will be sensed automatically.
- This unit can play back metal tapes as well as normal or chrome tapes, and recording can also be done on metal tapes.
- When covering erasure prevention tab holes, do not cover the chrome and metal detection holes. Otherwise, the deck will treat tape as normal tape.
- Do not press the EJECT button during playback or recording.



TAPE DECK OPERATION

Receiver

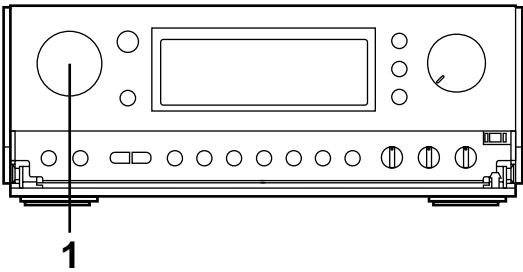

DECK A selector button
DECK B selector button

Tape Deck

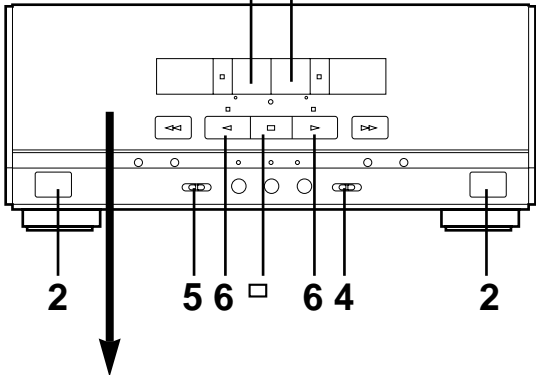

3

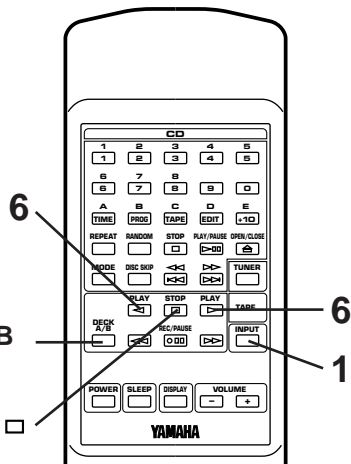
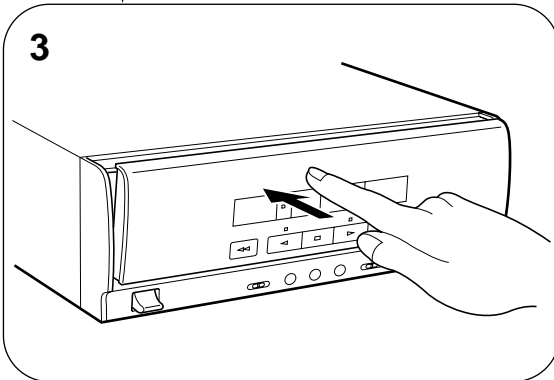

DECK A/B button

Tape A or tape B playback

- 1 Select the TAPE position with the INPUT SELECTOR control, watching the display.
- 2 Open the DECK A or DECK B cassette compartment by pressing the EJECT button.
- 3 Load the tape into the DECK A or DECK B cassette compartment, and close the lid panel completely by pressing the upper part of the center of the panel as figured left.
 - * If you have loaded two tapes into both the DECK A and B cassette compartments, select the DECK A or B in which the tape you want to play back is loaded by pressing the DECK A or B selector button.
- 4 Set the Dolby NR switch to B or C if the tape is recorded with Dolby noise reduction, and to OFF if Dolby NR is not used.
 - * For selection of the Dolby B or C position, refer to the "Dolby B and C Type Noise Reduction" on page 29.
- 5 Set the reverse MODE switch as desired.

The reverse MODE switch can be operated before or during playback, and changes tape playback as follows:

	Side A only	Side A → Side B	Side A → Side B (Repeats 8 times) Starts from side A.
	Side B only	Side B only	Side A → Side B (Repeats 8 times) Starts from side B. (Side A is not played at the first time.)

- 6 Press the play button to listen to side A, or the play button for side B.

To stop playback

Press the stop button.

Note

When removing the tape, press the stop button, and then open the cassette compartment.

Direct operation

Even if an input source other than tape deck is selected, pressing the play button (or the fast wind button) will start playback (or fast winding) directly.





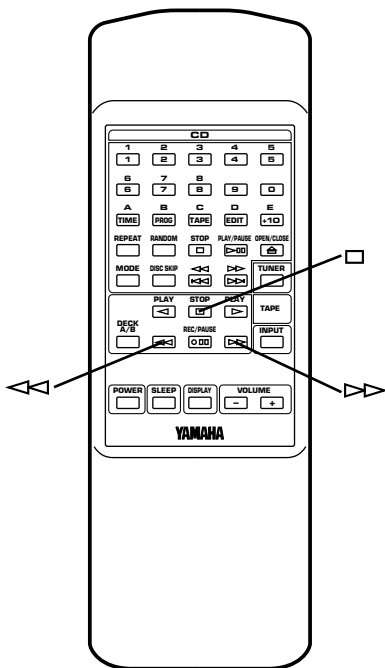
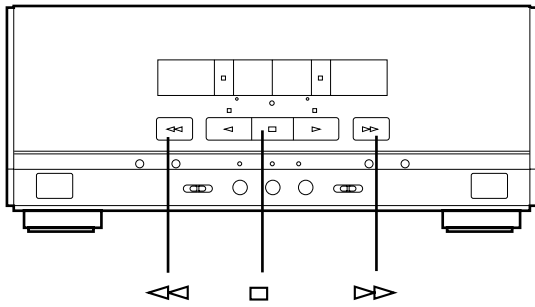

TAPE DECK OPERATION

Tape Deck



Winding the tape



- 1 If during playback, first press the stop  button.
- 2 Next press the fast wind  or fast wind  button to wind the tape.
- 3 Press the stop  button to stop.

* While winding the tape, the corresponding play direction indicator flashes rapidly.

Note

When the tape is wound to the end, this unit will then function as described below, according to the setting of the reverse MODE switch.

 : The tape stops at the end.

 : If the winding direction is , when the tape reaches the end, playback automatically starts from the reverse side.



If the winding direction is , the tape stops at the end.



 : When the tape reaches the end, playback automatically starts from the reverse side.

Searching for the beginning of a desired selection



Carry out the following operation during playback to find the beginning of a desired selection on the tape.



To listen to the same selection

Press the  button if the direction of the current playback is .

Press the  button if the direction of the current playback is .

To listen to the next selection

Press the  button if the direction of the current playback is .

Press the  button if the direction of the current playback is .

* While searching, the corresponding play direction indicator flashes slowly.

Notes

- This function may not work for tapes with
 - * Material with long pauses or quiet passages.
 - * Low recording levels or excessive noise.
 - * Pauses of less than 4 seconds between selections.
- If searching is carried out at the first or the last part of a selection, the desired selection may not be found.



TAPE DECK OPERATION

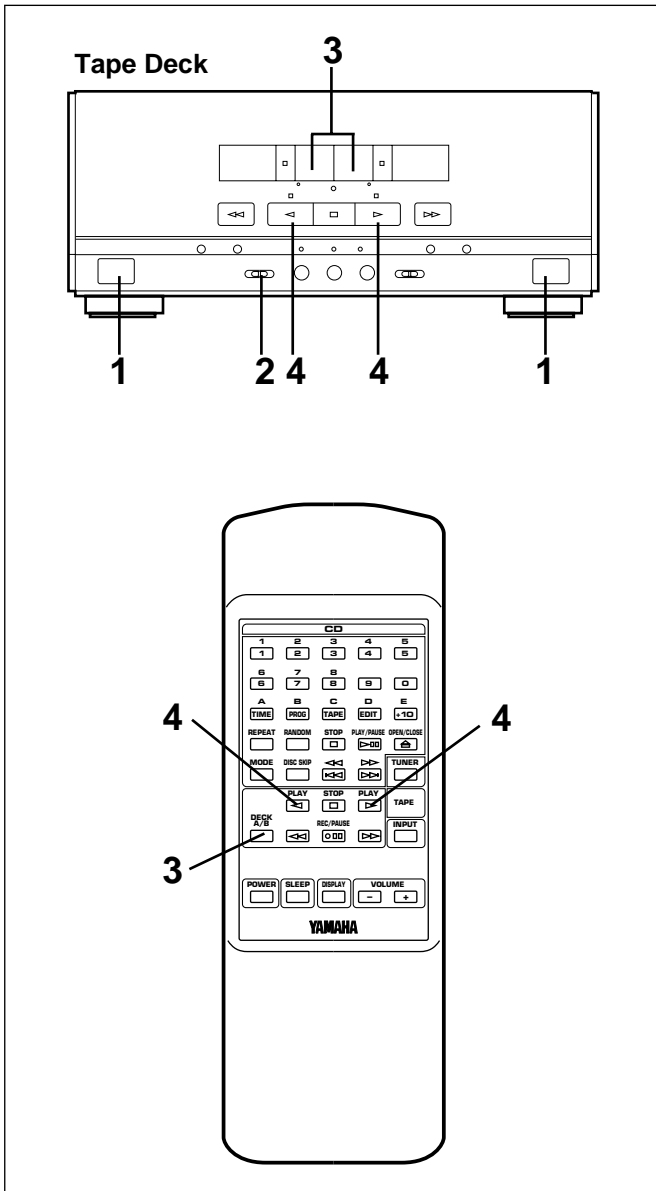

Continuous playback

- 1 Load the tapes into the DECK A and DECK B cassette compartments.
- 2 Set the reverse MODE switch to

The reverse MODE switch can be operated before or during playback, and changes tape playback as follows:

<Tape A> 	Tape A Side A → B → Tape B Side A → B (Repeats 8 times) Starts from Tape A Side A.
<Tape A> 	Tape A Side A → B → Tape B Side A → B (Repeats 8 times) Starts from Tape A Side B. (Tape A Side A is not played at the first time.)

- 3 Press the DECK A or B selector button to select the tape to be played back first.
- 4 Press the play button to listen to side A, or the play button for side B.

Dolby B and C Type Noise Reduction

With cassette tapes, the most noticeable form of noise is high frequency hiss. To reduce this hiss noise, this unit has been equipped with a newly developed Dolby C noise reduction system in addition to its conventional Dolby B NR. Either type of noise reduction may be selected with the switch provided. Dolby B NR has a noise reduction effect of about 10 dB in the high frequency range. The corresponding figure with Dolby C NR is about 20 dB, but this is over the entire range where the human ear is most sensitive to noise (2 kHz to 8 kHz). Also, Dolby C NR has the same noise reduction effect at both high and low signal levels. In addition, Dolby C NR improves the tape's MOL (Maximum Output Level). Dolby noise reduction is a 2 part process that acts both on recording and playback; be sure that the noise reduction button is set to the same position on record and play.

* Noise in the source material cannot be reduced with the Dolby NR system.

Dolby noise reduction manufactured under license from Dolby Laboratories Licensing Corporation. "DOLBY" and the double-D symbol are trademarks of Dolby Laboratories Licensing Corporation.



RECORDING COMPACT DISCS

Receiver

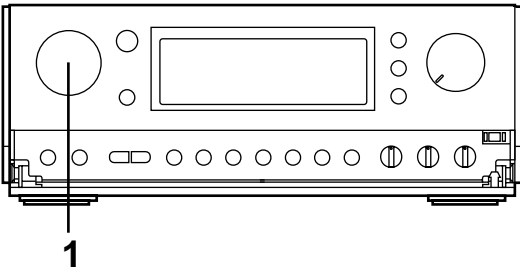

CD Player

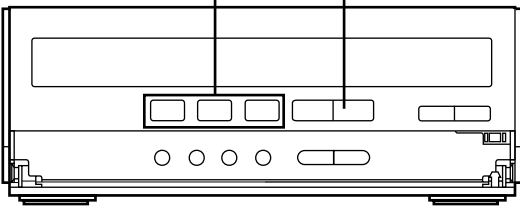

Tape Deck

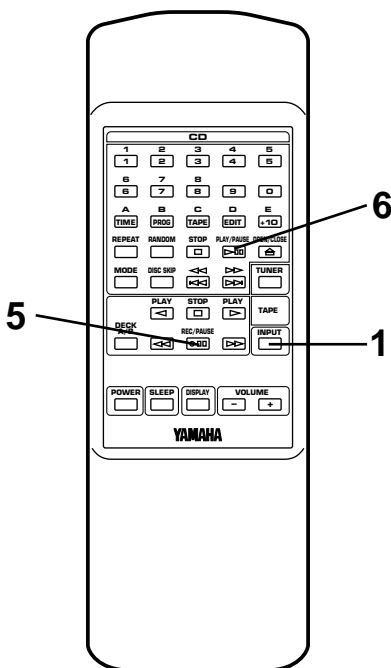
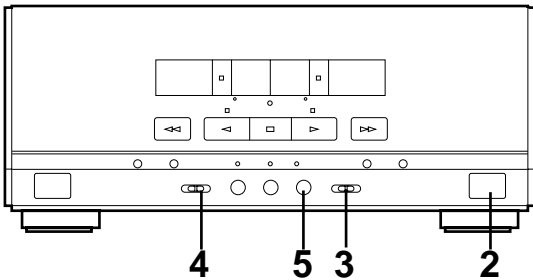

- When recording important selections, be sure to make a preliminary test to ensure that the desired source material is being properly recorded with good sound quality.
- The automatic recording level control circuit automatically controls the level of the input signal used for recording.
- Adjusting the VOLUME, BALANCE, TREBLE and BASS controls have no effect on the recorded sound.
<Except U.K. and Europe models>
If, however, the DSS is on, DSS effect is recorded along with the source.
* Music with DSS effect is suitable for listening to inside a car etc.
- The deck which can be used for recording is the DECK B only. When recording, be sure to load a tape into the DECK B cassette compartment.

CD synchronized recording

- 1 Select the CD position with the INPUT SELECTOR control, watching the display, and load the disc to be recorded.
- 2 Load a tape into the DECK B cassette compartment.
* Wind past the beginning part of the tape on which recording cannot be performed.
- 3 When recording with the Dolby NR system, set the Dolby NR switch to B or C; if not, set it to OFF.
* For selection of the Dolby B or C position, refer to the "Dolby B and C Type Noise Reduction" on page 29.
- 4 Set the reverse MODE switch as desired.

When the tape is set so that side A faces you, recording will be done as follows automatically according to the selected reverse mode.

	Side A only	Side A → Side B	Side A → Side B
	Side B only	Side B only	Side B only

- 5 Press the REC/PAUSE button.
* The corresponding indicator lights up and the play direction indicators flash.
- 6 Start CD playback by pressing the corresponding disc selector button, or by pressing the play/pause >/|| button if the disc is already selected.
* Before CD playback begins, recording automatically begins on the side of the tape now selected.



RECORDING COMPACT DISCS

CD Player

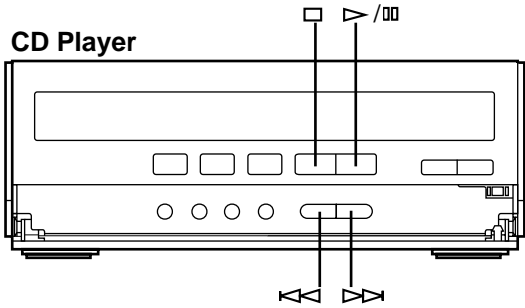

Tape Deck

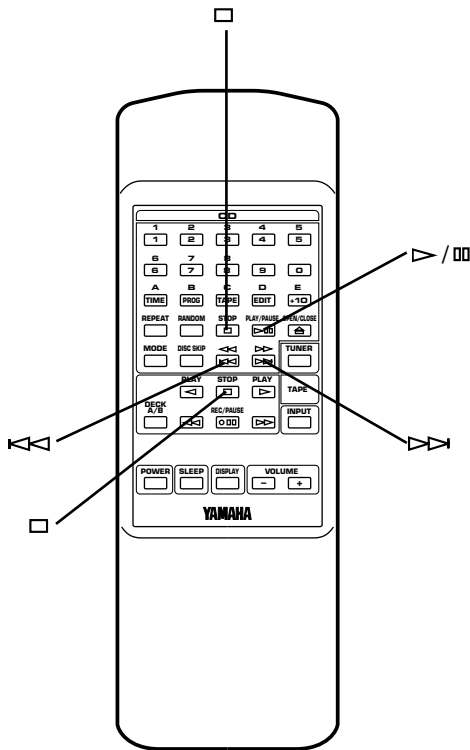
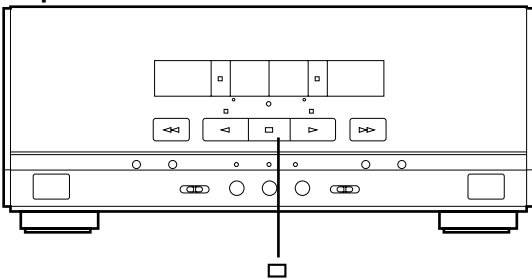

To stop recording temporarily

- 1 Press the stop button of the CD player.
- 2 Choose the selection to be recorded next by using the SKIP or button, and then press the play/pause button of the CD player to resume recording (or simply press the track number input button on the remote control transmitter).

To stop recording

Press the stop button of the tape deck.
(At this time, CD playback will not stop.)

Recording programmed tracks

Programmed tracks from one or more discs can also be recorded in the same way.

- 1 Program desired tracks from one or more discs. (Refer to page 15. for the programming procedure.)
- 2 Follow steps 2–5 on the previous page.
- 3 Press the play/pause button of the CD player.

Notes

- During CD Synchronized Recording, when more than 4 seconds elapse between tracks, the tape will stop automatically and resume recording when the beginning of the next track is found.
- The CD Synchronized Recording will function even when the CD player is turned into random play mode.



RECORDING COMPACT DISCS

Receiver

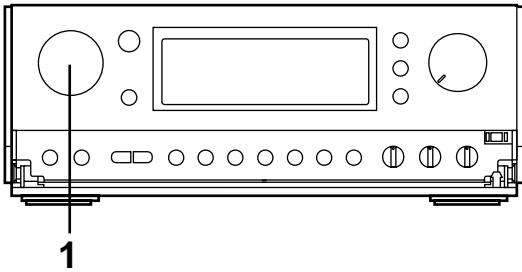

CD Player

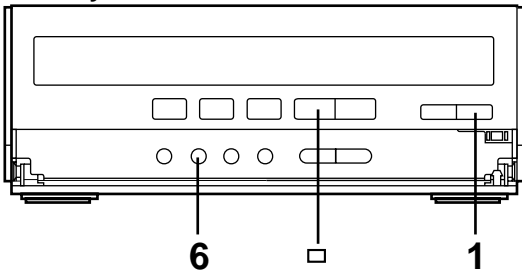

Tape Deck

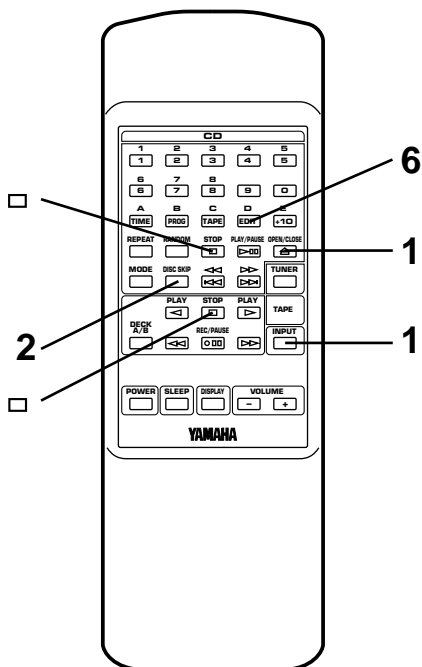
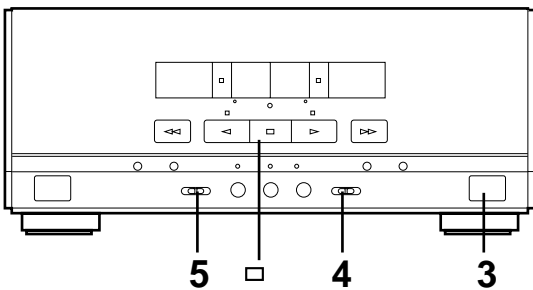

Recording CD(s) on both sides of a tape automatically

- 1 Select the CD position with the INPUT SELECTOR control, watching the display, and load the disc to be recorded.
- 2 Select the disc by pressing the DISC SKIP button.
- 3 Load a tape into the DECK B cassette compartment.
- 4 When recording with the Dolby NR system, set the Dolby NR switch to B or C; if not, set it to OFF.
 - * For selection of the Dolby B or C position, refer to the "Dolby B and C Type Noise Reduction" on page 29.
- 5 Set the reverse MODE switch to or .
- 6 Press the EDIT button. ("EDIT" appears on the display.) CD playback and recording starts. Recording is carried out on side A and B of the tape continuously.
 - * If the tape has not rewound to the end, it is rewound to the end rapidly before recording starts. Recording starts from the first part of the tape on which recording can be done.
 - * "A " (or " B") on the display shows the side of the tape on which recording is being carried out.
 - * When the recording on side A finishes while a track is being played back, the sound is automatically faded out, and then the recording stops. The recording on side B starts from the beginning of the same track.

Notes

- When this CD player is in the all disc play mode, if the tape's total possible recording time is longer than the total playing time of the selected disc, tracks on another disc are recorded continuously. In this case, as many as three discs can be recorded automatically.
- During recording, the PLAYXCHANGE button on the CD player is disabled.
- The CD player's repeat play mode will be canceled during this recording mode.

Recording programmed tracks

Programmed tracks from one or more discs can also be recorded in the same way.

- 1 Program desired tracks from one or more discs. (Refer to page 15 for the programming procedure.)
- 2 Follow steps 3–6 described above.

To stop recording

Press the stop button of the tape deck or the CD player.



RECORDING COMPACT DISCS

Receiver

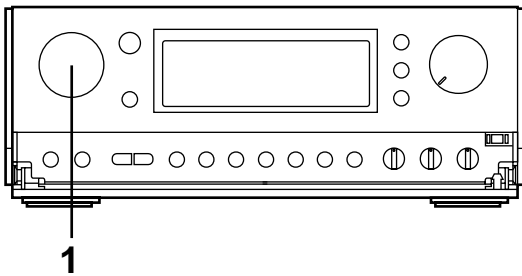

CD Player

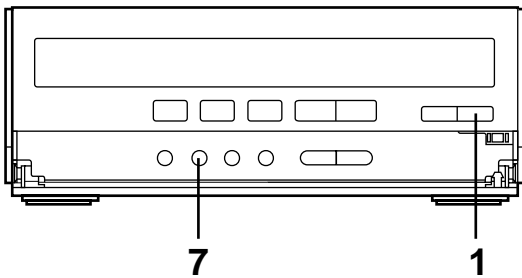

Tape Deck

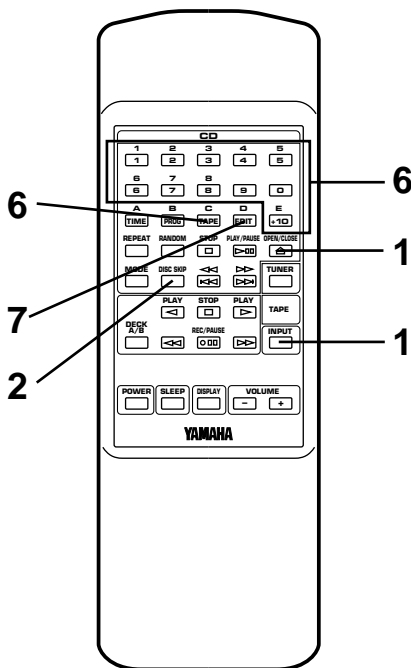
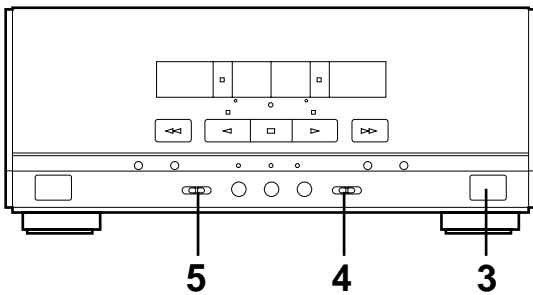

Automatic tape-editing

This convenient feature can be used to program tracks on a disc (or discs) for recording to tape. By only memorizing the tape's total possible recording time, the unit will automatically program tracks or help you to program tracks so they will fit onto the tape with the least amount of unrecorded space remaining at each end of the tape.

To record a disc with the order of tracks unchanged

- 1 Select the CD position with the INPUT SELECTOR control, watching the display, and load the disc to be recorded.
- 2 Select the disc by pressing the DISC SKIP button.
- 3 Load a tape into the DECK B cassette compartment.
- 4 When recording with the Dolby NR system, set the Dolby NR switch to B or C; if not, set it to OFF.
* For selection of the Dolby B or C position, refer to the "Dolby B and C Type Noise Reduction" on page 29.
- 5 Set the reverse MODE switch to or .
- 6 Press the TAPE button on the remote control transmitter to select the length of the tape to be used. Whenever pressed, C-46, C-54, C-60 and C-90 appear on the display in turn, and next it returns to the normal display mode.

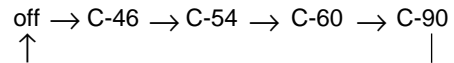

When using tapes other than C-46, C-54, C-60 or C-90

When C-46, C-54, C-60 or C-90 is appearing on the display, input the tape length by using the track number input buttons on the remote control transmitter.
(Examples)
C-62: Press "6" and then "2".
C-30: Press "3" and then "0", or press "+10" three times and then "0".

- 7 Press the EDIT button. ("EDIT" appears on the display.) The following internal operations are carried out before recording is automatically started.
* If the tape has not rewound to the end, it is rewound to the end rapidly before recording starts.
 - 1) Tracks on the disc are automatically divided between side A and side B. You can check the process by watching the display.
 - 2) The end part of the tape on which recording cannot be done is wound.
 - 3) CD playback and recording starts. Recording is carried out on both side A and B of the tape.



RECORDING COMPACT DISCS

CD player

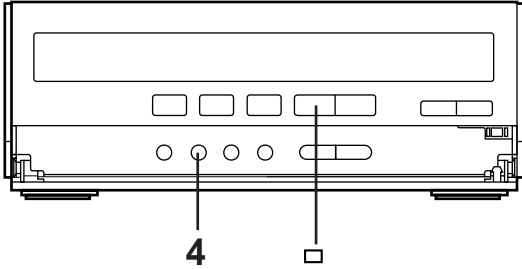

Tape Deck

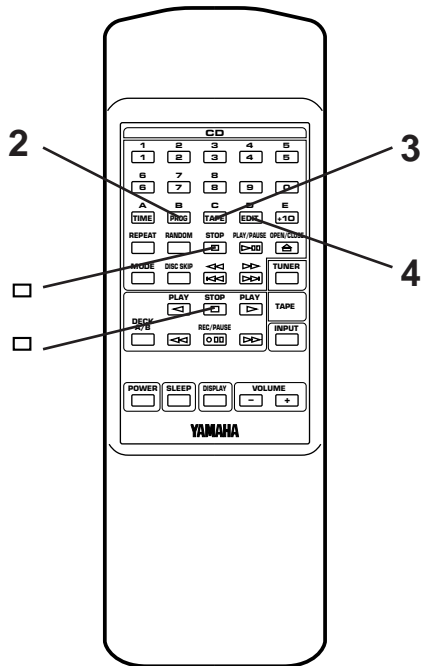
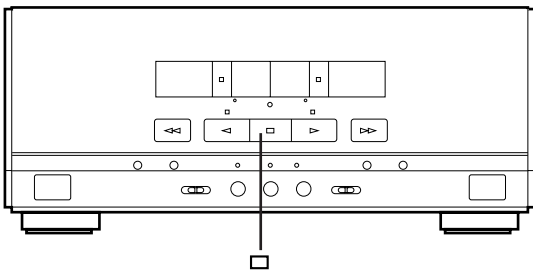

Notes

- When this CD player is in the all disc play mode, if the tape's total possible recording time is longer than the total playing time of the selected disc, tracks on another disc are recorded continuously. In this case, as many as three discs can be recorded automatically.
- The CD player's repeat play mode will be canceled during this recording mode.



To cancel tape-editing function

Before recording, press the stop  button of the CD player.

To stop recording

Press the stop  button of the tape deck or the CD player.

To make this unit program tracks on a disc automatically so that the least amount of unrecorded space remains on the tape

- 1 Follow steps 1–6 on the previous page.
- 2 Press the PROG button.
- 3 Press the TAPE button.
“AP A> ” will light up during programming for side A, and “AP B> ” will light up during programming for side B.

* After “AP B> ” goes out from the display, you can check the programmed contents for side A and B respectively. To check, cancel or correct program data, refer to page 16.
- 4 Press the EDIT button. (“EDIT” appears on the display.) The recording automatically starts.



RECORDING COMPACT DISCS

Receiver

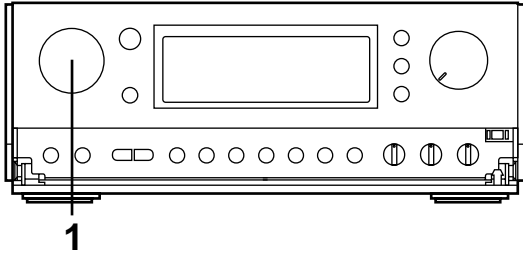

CD Player

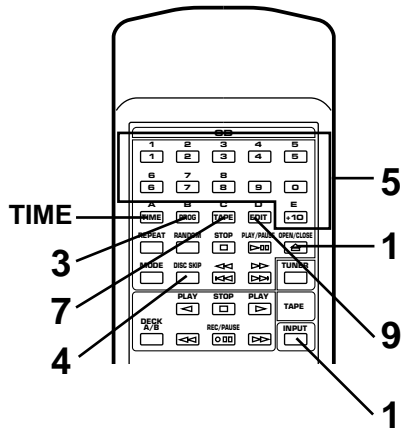
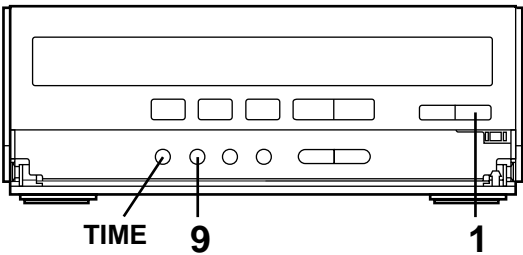

Display information during programming

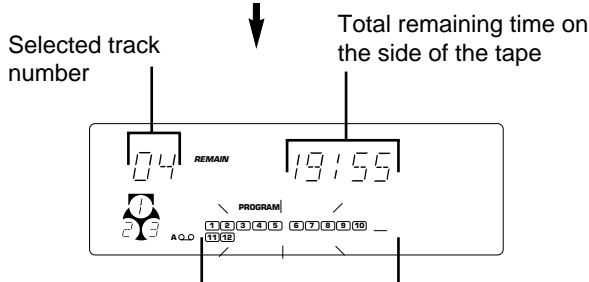
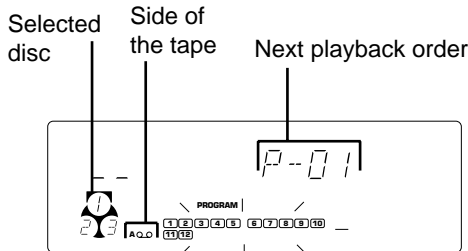

Programmed track numbers light up and unprogrammed ones flash.

To record programmed tracks from one or more discs

- 1 Select the CD position with the INPUT SELECTOR control, watching the display, and load a disc (or discs) on the disc table.
- 2 Follow steps 3–6 on page 33.
- 3 Press the PROG button.
 - * "PROGRAM" and "P-01" light up on the display, and all track numbers on the selected disc begin flashing.
- 4 If necessary, select a desired disc by pressing the DISC SKIP button.
- 5 Select the desired track number by pressing the track number input buttons.
- 6 Repeat steps 4 and 5 to program more selections for the side A of the tape. You can select the same track again.
 - * Pressing the TIME button displays the total remaining time on the side of the tape for about 1 second, and then it is replaced by the display of the next playback order.
 - * If "ERR" appears on the display, the track number just selected cannot be programmed because there is not enough time remaining on the side A of the tape. However, at this time, if any other track number is flashing continuously on the display, you can program it instead of the unprogrammable one.
- 7 After you finish the programming for the side A, press the TAPE button.
 - * "Pu" appears on the display, then you can begin programming for side B.
- 8 Repeat steps 4 and 5 to program selections for the side B of the tape. You can select the same track again.
 - * If "ERR" appears on the display, the track number just selected cannot be programmed because there is not enough time remaining on the side B of the tape. However, at this time, if any other track number is flashing continuously on the display, you can program it instead of the unprogrammable one.
- 9 Press the EDIT button. ("EDIT" appears on the display.) The recording automatically starts.

Notes on tape-editing

- If programs are made selecting tracks from more than one disc, during recording, the PLAYXCHANGE button on the CD player is disabled.
- To check, cancel or correct program data, refer to page 16.
- The maximum number of tracks that can be programmed is 20.
- This function can be used to program up to track number 20. If the disc has more than 20 tracks, track number 20 and thereafter will not be programmed.



OTHER RECORDINGS

Receiver

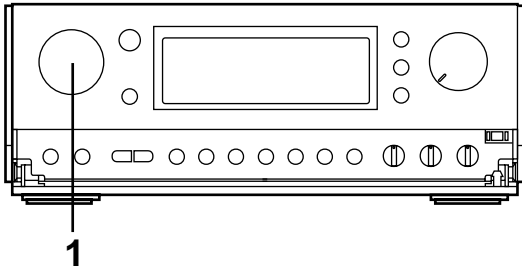

Tape Deck

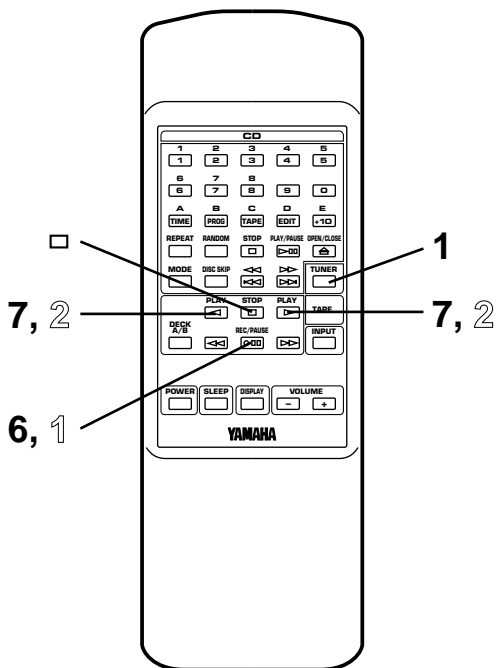
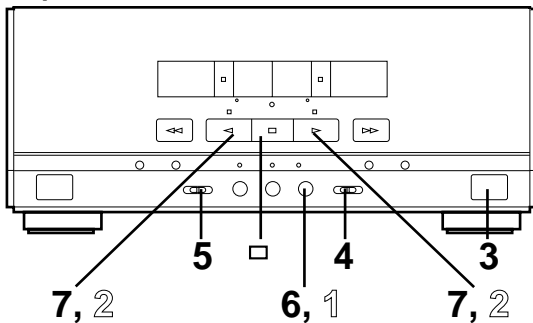

- When recording important selections, be sure to make a preliminary test to ensure that the desired source material is being properly recorded with good sound quality.
- The automatic recording level control circuit automatically controls the level of the input signal used for recording.
- Adjusting the VOLUME, BALANCE, TREBLE and BASS controls have no effect on the recorded sound.
<Except U.K. and Europe models>
If, however, the DSS is on, DSS effect is recorded along with the source.
* Music with DSS effect is suitable for listening to inside a car etc.
- The deck which can be used for recording is the DECK B only. When recording, be sure to load a tape into the DECK B cassette compartment.

Recording from the built-in tuner

- 1 Select the TUNER position with the INPUT SELECTOR control, watching the display.
- 2 Tune to the desired station. (Refer to the "TUNING OPERATION" on pages 19 and 20.)
- 3 Load a tape into the DECK B cassette compartment.
- 4 When recording with the Dolby NR system, set the Dolby NR switch to B or C; if not, set it to OFF.
* For selection of the Dolby B or C position, refer to the "Dolby B and C Type Noise Reduction" on page 29.
- 5 Set the reverse MODE switch to to record on only one side, or to (or) for continuous recording on both sides.
- 6 Press the REC/PAUSE button.
* The corresponding indicator lights up and the play direction indicators flash.
- 7 Press the play button to record on side A, or the play button to record on side B.
* For continuous recording on both sides, begin on side A. Recording stops automatically at the end of side B.

To stop recording temporarily

- 1 Press the REC/PAUSE button.
- 2 To resume recording, press the play button whose indicator is flashing.

To stop recording

Press the stop button.



OTHER RECORDINGS

Dubbing

- During dubbing, adjusting the VOLUME, BALANCE, TREBLE and BASS controls have no effect on the recorded sound.
<Except U.K. and Europe models>
If, however, the DSS is on, DSS effect is recorded along with the source.
* Music with DSS effect is suitable for listening to inside a car etc.
- Try to use the same tape formula and length for the recording tape as for the master tape.

Receiver

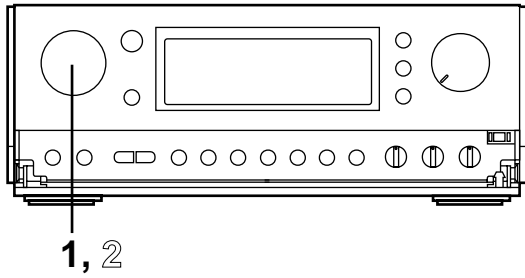

Tape Deck

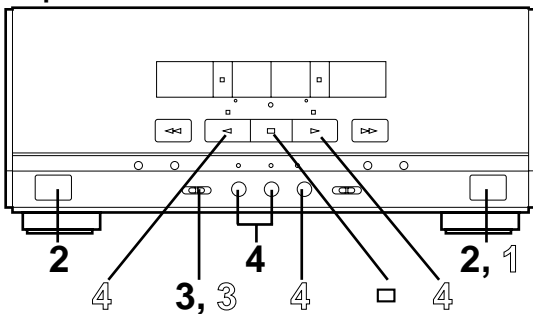

- 1 Select the TAPE position with the INPUT SELECTOR control, watching the display.
- 2 Load a prerecorded tape into the DECK A cassette compartment. Insert a blank tape into the DECK B cassette compartment.
- 3 Set the reverse MODE switch to \rightleftarrows to record on only one side, or to \rightarrow (or \leftarrow) for continuous recording on both sides.
- 4 Press the DUBBING button.
* Press "NORMAL" to dub at normal speed, and "HIGH" to dub at about twice the normal speed.
* Dubbing will begin from side A regardless of the side now selected.

To stop dubbing

Press the stop \square button.

- * Tape A and tape B will stop at the same time.

Note

Only tapes originally encoded with Dolby B or C NR will be dubbed onto tapes with Dolby B or C NR encoding. The setting of Dolby NR will have no effect on the recording of tape B during dubbing. However, the playback tonal quality of tape A will change according to the Dolby NR switch position.

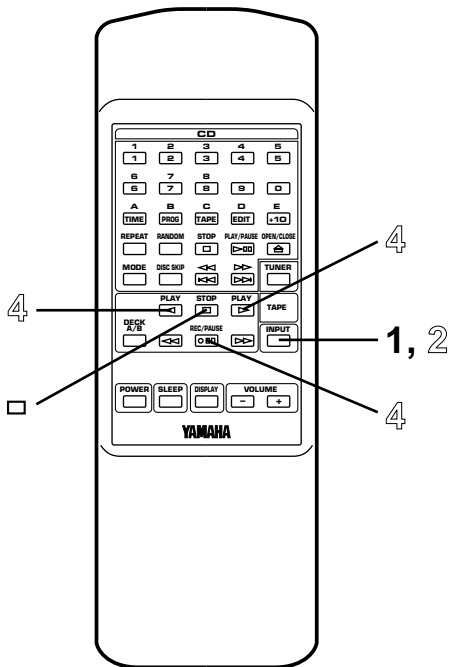

Erasing recorded tapes

- 1 Load the tape to be erased into the DECK B cassette compartment.
- 2 Select the TAPE position with the INPUT SELECTOR control, watching the display.
- 3 Set the reverse MODE switch to \rightleftarrows to erase only one side and to \rightarrow (or \leftarrow) to erase both sides.
- 4 Press the REC/PAUSE button, then press the play \triangleright button to erase side A of the tape, or the play \triangleleft button to erase side B.

Timer play

By using the built-in timer, you can set the time when the unit turns on and a source begins playing automatically, and the time when the unit turns off automatically.

- 1 Prepare the source to be played.

For tuner:

Tune in to the station you will listen to.

For tape deck:

Load a tape into the cassette compartment.
(If tapes are loaded in both the compartments, tape A takes priority of tape B, and is played back by the timer play.)

For CD player:

Load a disc on the disc table. If more than one disc are loaded on the disc table, select the disc by using the disc selector buttons or the DISC SKIP button.

- 2 Press the DISPLAY button.

Whenever the DISPLAY button is pressed, the display mode changes as follows.

At each mode, make a setting for the timer play, referring to the setting procedure described below.

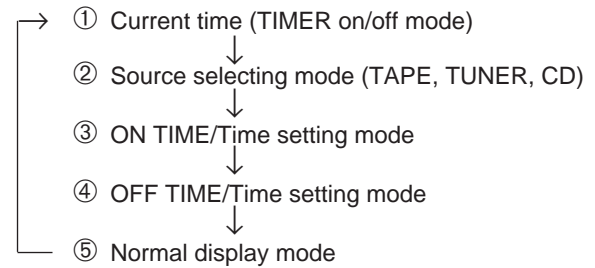

* The display mode will be changed to the next mode after about 8 seconds elapse automatically. If the mode is changed before the setting is completed, call the mode again by pressing the DISPLAY button once or more.

Setting procedure:

- ① **At the display of current time**
Check to be sure that the current time is correct, and press the TIMER button so that "TIMER" lights up on the display.
- ② **At source selecting mode**
Select the source (TAPE, TUNER or CD) to be played with the INPUT SELECTOR control.
* If "TUNER" is selected, soon it is changed to the frequency display mode. In this mode, you can select the station to listen to with the timer play by using the BAND button, A/B/C/D/E button and TUNER PRESET DOWN/UP buttons.

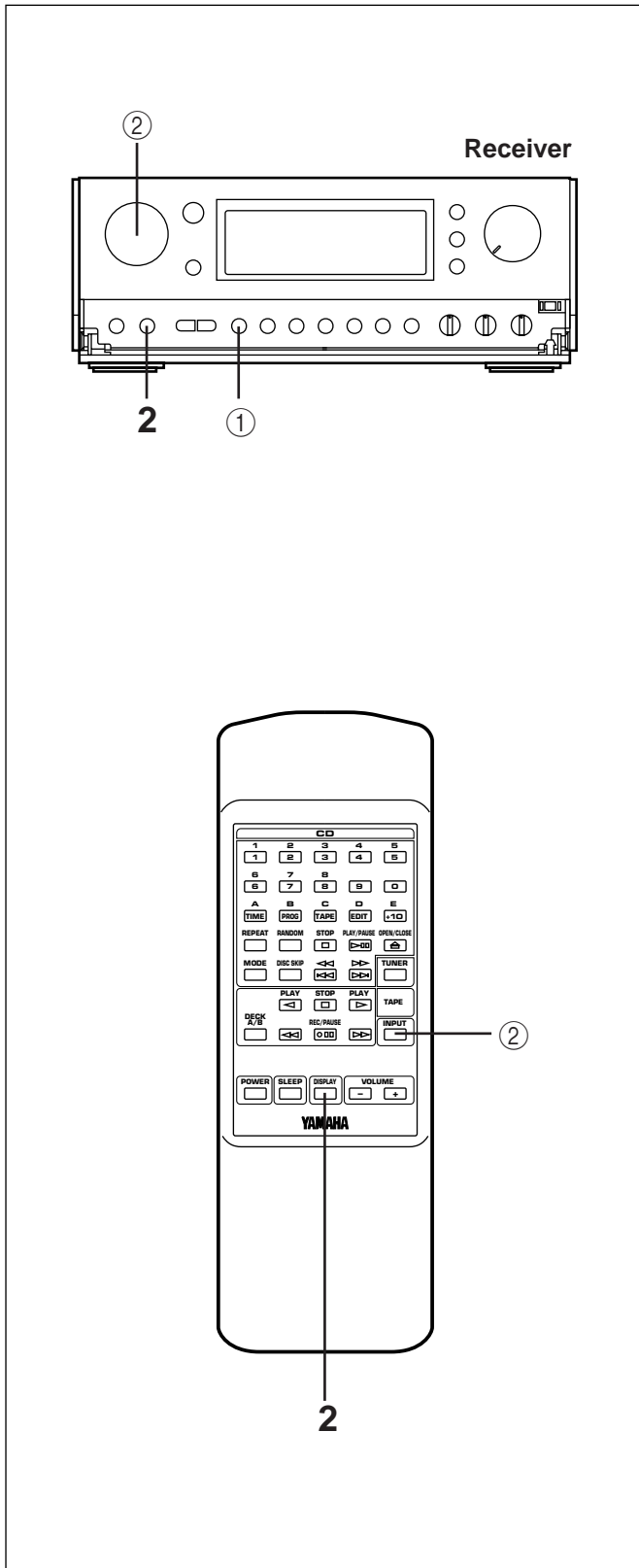

HOW TO USE THE BUILT-IN TIMER

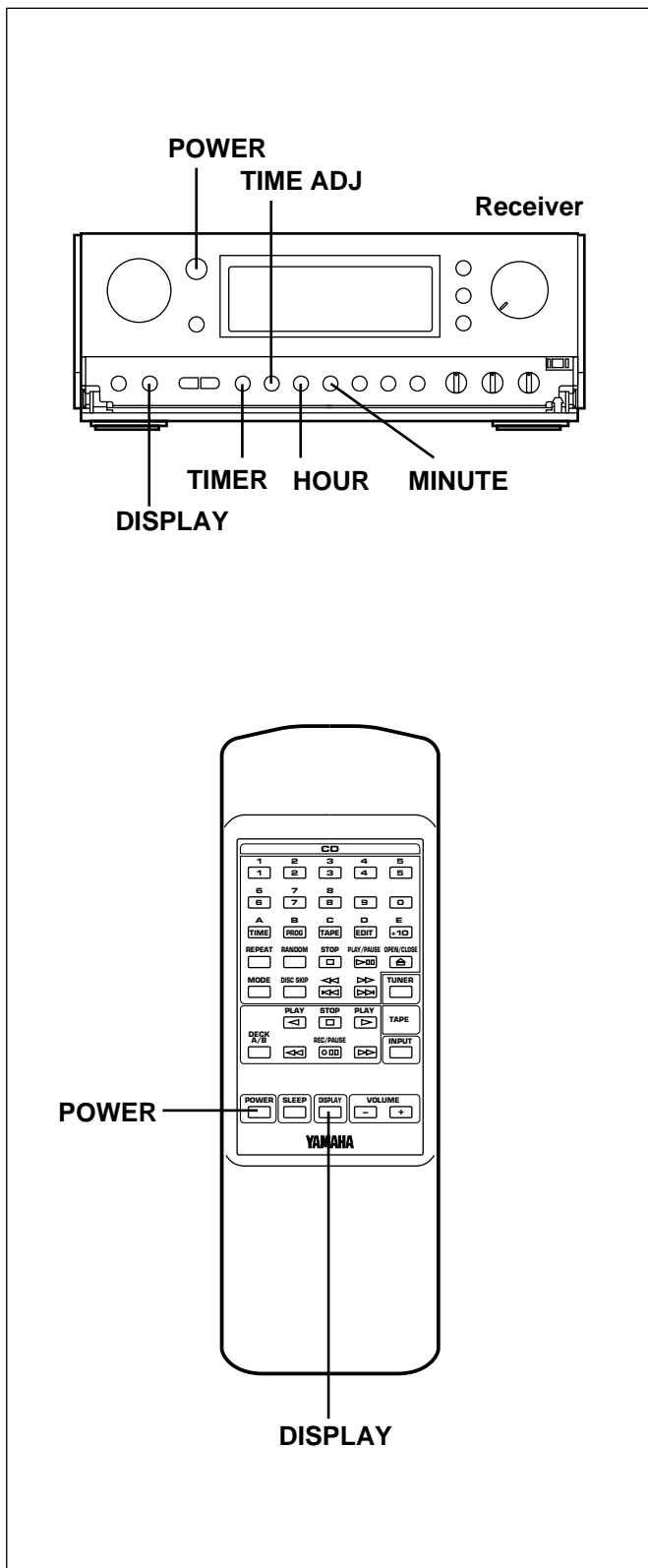

③ **At ON TIME/time setting mode**
 ["ON TIME" appears on the display, and soon it is changed to a time setting mode.]
 Set to the time when you want to begin the timer play by using the HOUR button and the MINUTE button.

④ **At OFF TIME/time setting mode**
 ["OFF TIME" appears on the display, and soon it is changed to a time setting mode.]
 If necessary, set to the time when you want to finish the timer play (to turn this unit off) by using the HOUR button and the MINUTE button. Even if you do not set the time, it has already been set so that the timer play finishes after 1 hour.

* The TIMER button functions also in the time (ON TIME or OFF TIME) setting mode. (However, it also turns off the power.)

3 If you will not use this unit until the timer play begins, turn the power off by pressing the POWER switch or the TIMER button.

Note

If a timer play setting is made and the power is not turned off, the source set for the timer play will begin playing when the time comes in place of the source played at that time.

To cancel the timer play setting

After the timer play is finished, press the DISPLAY button to call the current time. While the current time is displayed, press the TIMER button so that "TIMER" goes out from the display.

If it is not canceled, the system will be turned on at the same time every day, so it can be used as an alarm. However, if you are planning to go out at that time, cancel the timer play setting.

* Unless the AC supply lead is unplugged or there is a power failure for more than 5 minutes, the time set on the timer will be retained until it is reset.

How to make time setting in the ON TIME or OFF TIME mode

For the hour:

Press the HOUR button to change the hour to a higher value. Press and hold to change continuously.
 To change the hour to a lower value, while pressing the TIME ADJ button, press the HOUR button.

For the minute:

Use the MINUTE button and operate it in the same way as you did to change the hour.

HOW TO USE THE BUILT-IN TIMER

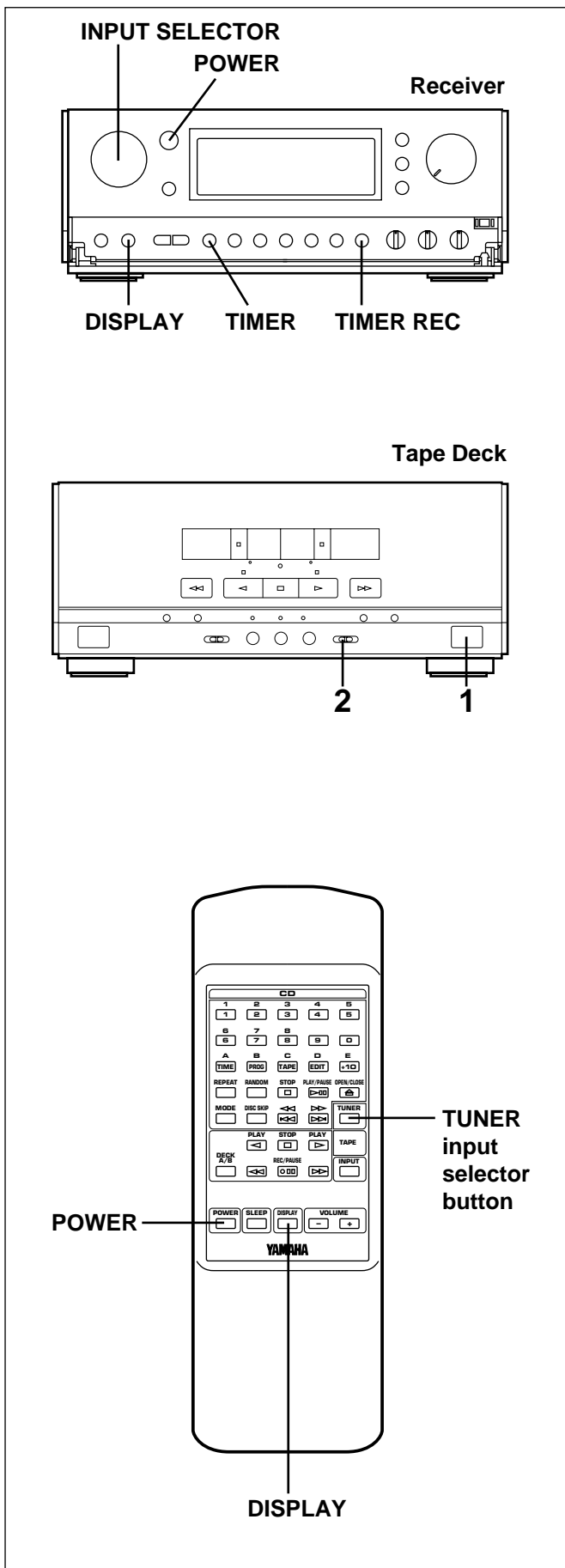

Timer recording (To record a tuner program)

- 1** Load a blank tape into the DECK B cassette compartment.
- 2** If desired, change the setting of the reverse mode and the Dolby NR position.
- 3** Tune to the station of which program you want to record.
- 4** Follow step 2 of the "Timer play" on page 38 and 39.
 - * In step ②, select the TUNER position with the INPUT SELECTOR control, and then press the TIMER REC button. ("REC" will flash on the display.)
 - * In step ③, set the time when you want to begin the timer recording.
 - * In step ④, set the time when you want to finish the timer recording.
- 5** Press the TIMER button. (The power will be turned off automatically.)
 - * If a normal display mode (the state which had been selected before you began setting the timer recording) is restored before you press the TIMER button, select and follow either of the two methods below.
 - Press the DISPLAY button, and then press the TIMER button. (The power is still on.)
 - Press the POWER switch to turn the power off, and then press the TIMER button. (The power is turned off.)

To confirm the timer time setting

Press the DISPLAY button.

To cancel the setting of timer recording

Press the DISPLAY button once or more so that "REC" flashes on the display. While "REC" is flashing, press the TIMER REC button.

* Unless the AC supply lead is unplugged or there is a power failure for more than 5 minutes, the time set on the timer will be retained until it is reset.

Note

When the timer recording is finished, the timer setting is automatically canceled to avoid repeating timer recording of the same setting.

HOW TO USE THE BUILT-IN TIMER

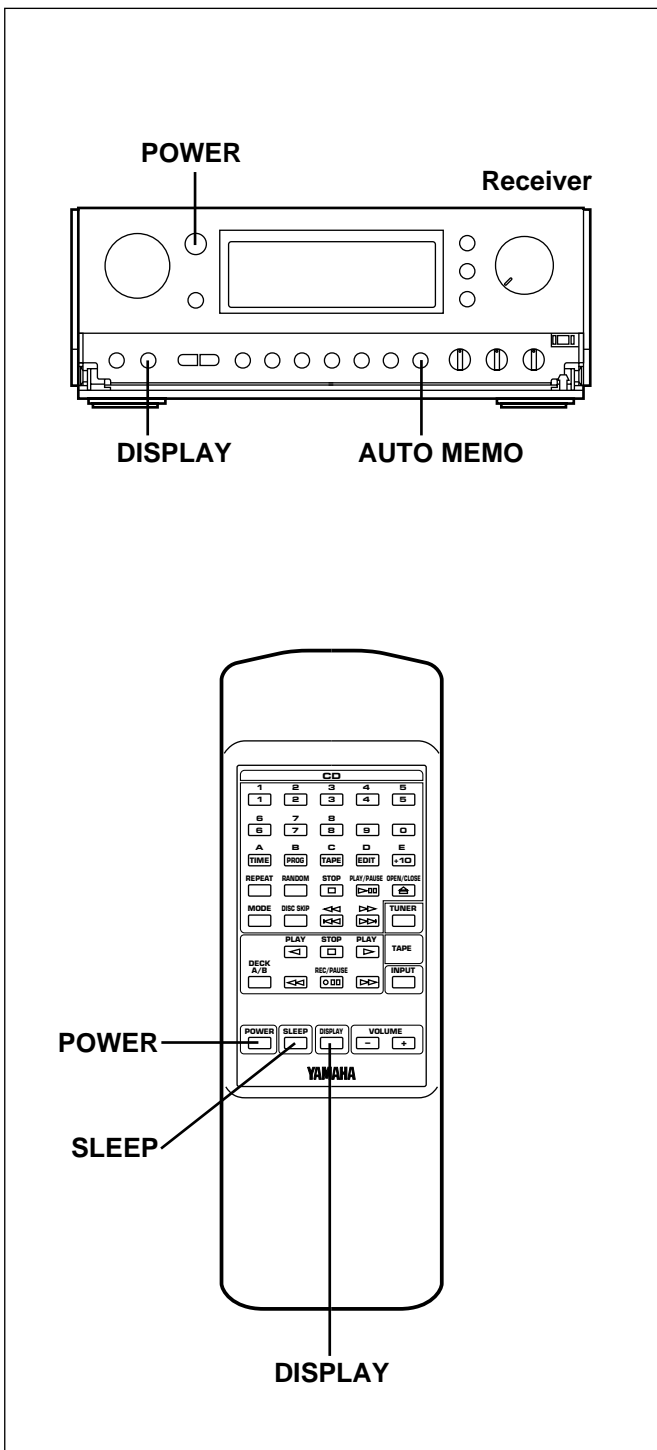

Sleep timer operation

This unit can be turned off automatically.

- 1 Play the desired sound source.
- 2 Press the SLEEP button. "SLEEP" appears on the display, and soon it is replaced by "2h00m".
- 3 Press the SLEEP button repeatedly until the desired sleep time appears on the display. The display will change as described below. [Time is displayed by the hour (h) and the minute (m).]

2h00m → 1h30m → 1h00m → 0h30m

↑
OFF SLEEP ←
(Sleep timer is off.)

- * The original display mode will resume about 4 seconds after the selection is made.
- * The SLEEP indicator will light up to indicate that the sleep timer is on.

- 4 The unit will turn off automatically when the selected sleep time passes.

To confirm the sleep time setting

Press the SLEEP button once. "SLEEP" appears on the display, and soon it is replaced by the remaining time of the selected sleep time.

To change the sleep time

While the SLEEP indicator is being illuminated, press the SLEEP button repeatedly until the desired time appears.

To stop the sleep timer operation

Press the POWER switch, or press the SLEEP button repeatedly until "OFF SLEEP" appears on the display. (The SLEEP indicator will go out.)

To set the sleep time using front panel buttons

First press the DISPLAY button to display the current time. Within 7 seconds, press the AUTO MEMO button. Whenever the AUTO MEMO button is pressed, the sleep time changes.

Using the timer and the sleep timer at the same time

- 1 Prepare timer play. (See page 38 and 39.)
 - * Do not turn the power of this unit off after the timer setting is finished.

- 2 Press the SLEEP button and set the sleep time.

When the sleep timer operation finishes, the timer will function to turn the source on at the preset time.

Note

Do not make the timer time setting so that the timer will start during sleep timer operation. (Since sleep timer operation has priority, the timer will not operate.)

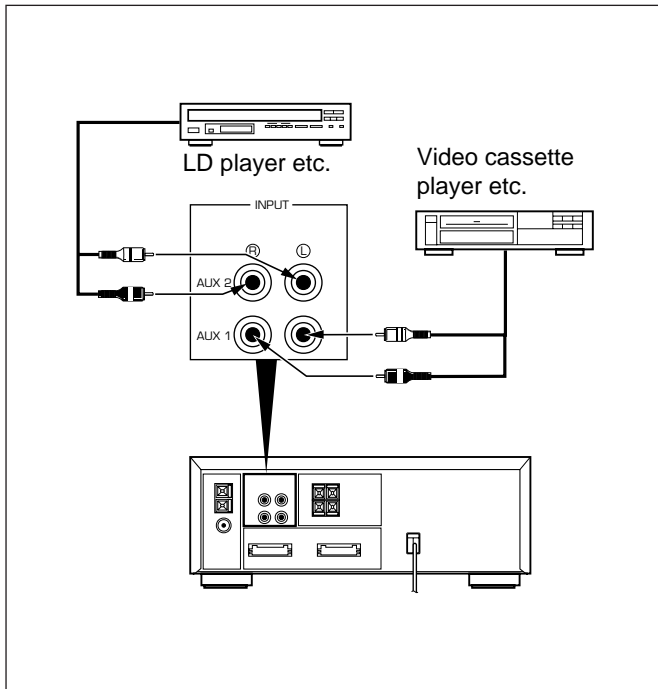

<U.S.A., Canada, Australia, Singapore and General models>

Other audio units (AUX1 and AUX2)

To connect

Connect the output terminals of a video cassette player, LD player, etc. to the AUX1 terminals of this system. (red → right channel, white → left channel)

To listen to

1 Select the AUX1 position with the INPUT SELECTOR control, watching the display.

2 Operate the unit connected to the AUX1 terminals.

* Its audio source can be recorded by this system's tape deck.

In the same way, connect another unit to the AUX2 terminals.

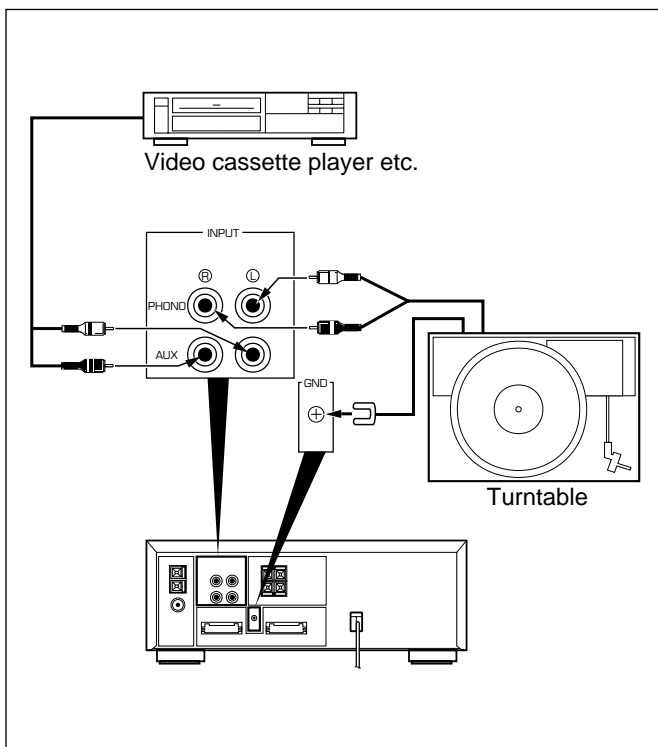

<U.K. and Europe models>

Another audio unit (AUX)

To connect

Connect the output terminals of a video cassette player, LD player, etc. to the AUX terminals of this system. (red → right channel, white → left channel)

To listen to

1 Select the AUX position with the INPUT SELECTOR control, watching the display.

2 Operate the unit connected to the AUX terminals.

* Its audio source can be recorded by this system's tape deck.

Turntable (PHONO)

To connect

1 Connect the output terminals of the turntable to the PHONO terminals of this system. (red → right channel, white → left channel)

2 Connect the GND lead of the turntable to the GND terminal of this system.

To listen to

1 Select the PHONO position with the INPUT SELECTOR control, watching the display.

2 Operate the turntable.

* Its audio source can be recorded by this system's tape deck.

DECK A

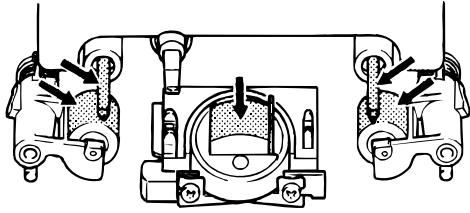

DECK B

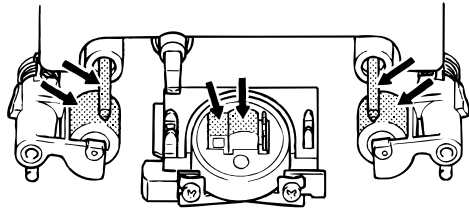

Internal care

- Dirty heads, capstans and pinch rollers can cause poor sound and tape jams. Clean these parts with a cotton swab moistened with commercially available head/pinch roller cleaner or isopropyl alcohol, or with a commercially available cleaning tape.
- After long use, the deck's heads and capstans may become magnetized, causing poor sound. Demagnetize these parts once every 30 hours of playing/recording time by using a commercially available tape head demagnetizer. Read the demagnetizer's instructions carefully before use.

External care

- Periodically clean the surfaces of this system, especially the top panel of the receiver to prevent the ventilation holes from being blocked with dust etc.
- Do not use chemically treated cleaning cloths or other chemicals. (See "Precautions".)

TROUBLESHOOTING

If your unit fails to operate normally, check the following points to determine whether the fault can be corrected by the simple measures suggested. If it cannot, or if the fault is not listed in the SYMPTOM column, disconnect the power cord and contact your authorized YAMAHA dealer or service center for help.

Should be service required, the servicer will need all three pieces [RX-S75, CDC-S75, KXW-S75].

	SYMPTOM	CAUSE	REMEDY
RECEIVER	No power even if the POWER switch is pressed.	AC supply lead is not plugged in.	Plug in the AC supply lead.
	No sound from one speaker	Loose speaker connections.	Connect properly.
	No sound from speakers.	Internal protection circuit is functioning.	Unplug the AC supply lead from the wall AC outlet, and then plug in again.
	Excessive static in FM broadcasts.	Interference from starting motor of nearby car.	Position the FM antenna as high and as far away from nearby roads as possible. Connect using a coaxial cable.
		Interference from thermostat of nearby electrical appliance.	
	Noise increases during stereo broadcasts.	Antenna input is too weak due to obstructions or excessive distance from broadcasting station.	Check antenna connections. Install a multi-element type FM antenna if possible.
	Stereo broadcasts are noisy and STEREO indicator blinks on and off.	Insufficient antenna input.	Install an antenna appropriate for the electric field strength of your area.
	Cannot select preset stations.	Preset memory has been erased.	Reprogram memory presets.
	Buzzing or static during AM (LW or MW) broadcasts.	Interference from source such as lightning, fluorescent lights, electric motors or thermostat of nearby electrical appliance.	Problem is difficult to eliminate but can be lessened by grounding MW/LW (AM) loop antenna.
		TV or microprocessor is being used nearby.	Move away from TV or microprocessor.
	AM (LW or MW) broadcast sensitivity is poor.	Radio signal is weak or antenna is not properly connected.	Properly connect MW/LW (AM) loop antenna.
			Change orientation of MW/LW (AM) loop antenna.
			Install an external MW/LW (AM) antenna.
Can't set timer.	Current time is not set.	Set current time.	
This unit will not operate properly.	The internal microcomputer has been frozen by an external electric shock (lightning, excessive static electricity, etc.) or power supply with low voltage.	Unplug the AC supply lead from the wall AC outlet, and then plug in again after about one minute.	
CD PLAYER	Play will not begin even if disc is loaded.	Disc is upside down.	Load disc label side up.
		Disc is dirty.	Clean disc.
	No sound.	Input selector setting is incorrect.	Select the CD input position.
	Sound stops suddenly (always at same spot).	Disc is dirty.	Clean disc.
Volume is set too high.		Lower volume.	
TAPE DECK	Tape won't move during playback or recording.	Slack tape wrapped around pinch roller.	Take up slack with a pencil before using.
	Can't record.	Erasure prevention tab is broken off.	Replace tape or cover erasure prevention hole with cellophane tape.
		Head is dirty.	Clean heads.
	Sound is distorted or fades out.	Head is dirty.	Clean heads.
		Head has become magnetized.	Demagnetize heads with head eraser.
		Tape is worn.	Replace tape.
	Poor sound quality.	Dolby NR switch is set to wrong position.	Set to positions matching those used when tape was recorded.
	Stereo balance is poor.	Head is dirty.	Clean heads.
	Excessive noise.	Head is dirty.	Clean heads.
		Head has become magnetized.	Demagnetize heads with head eraser.
		Tape is worn.	Replace tape.
	Tape travel stops in middle of playback or recording.	Slack tape coming out of cassette shell.	Take up slack by turning reels with a pencil.
		Tape is creased or torn.	Replace with new tape.
Endless tape is being used.		Don't use endless tapes.	
Can't find the beginning of desired selections on tape.	Silent gaps between selections are too short.	The function for searching for the beginning of desired selections won't operate unless the silent gaps between selections are at least four seconds long.	
	Excessively soft passages in middle of selections.		
	Conversation etc. is recorded.		
REMOTE CONTROL	Remote control doesn't work.	Batteries are dead.	Replace batteries.
		Remote control is too far away or is being used at incorrect angle.	Use within 6 m and 60° radius.
		Direct sunlight or lighting (of an inverter type of fluorescent lamp etc.) is striking the remote control sensor of the main unit.	Change position of the main unit.
	TV functions strangely when the remote control is used.	Remote control is being used near TV set with a remote control sensor.	Move TV farther away or cover its remote control sensor.

SPECIFICATIONS

As a part of policy of continuous improvement, YAMAHA reserves the right to make design and specification changes for product improvement without prior notice. The performance specification figures indicated are nominal values of production units.

■ Receiver (RX-S75)

Minimum RMS Output Power per Channel	
6 ohms, 1 kHz, 0.08% THD	55W+55W
6 ohms, 1 kHz, 10% THD	
[U.S.A., Canada, Singapore and General models only]	
	75W+75W
DIN Standard Output Power per Channel [Europe model only]	
6 ohms, 1 kHz, 1% THD	60W
IEC Power [Europe model only]	
6 ohms, 1 kHz, 0.1% THD	55W
Input Sensitivity/Impedance	
PHONO MM [U.K. and Europe models only]	
	2.5 mV/47 k-ohms
AUX	390 mV/20 k-ohms
Headphone Output Impedance	68 ohms
Total Harmonic Distortion (1 kHz)	
AUX to SP OUT (27.5W/6 ohms)	0.08%
Signal to Noise Ratio (IHF-A Network)	
AUX	90 dB
Tone Control Characteristics	
BASS: Boost/cut	±10 dB (50 Hz)
TREBLE: Boost/cut	±10 dB (20 kHz)
Tuning Range	
FM	
[U.S.A. and Canada models]	87.5 to 107.9 MHz
[Australia, U.K., Europe, Singapore and General models]	
	87.5 to 108.0 MHz
AM (MW)	
[U.S.A., Canada and General models]	530 to 1,710 kHz
[Australia, U.K., Europe and Singapore models]	
	531 to 1,611 kHz
LW	
[U.K. and Europe models only]	153 to 288 kHz
Usable Sensitivity	
FM (75 ohms)	
(30 dB S/N Quieting, 1 kHz, 100% mod.)	
[U.S.A., Canada, Singapore and General models]	
	1.2 μV (12.8 dBf)
(DIN, Mono, S/N 26 dB)	
[U.K., Europe and Australia models]	1.5 μV
AM (MW)	280 μV/m
LW	560 μV/m
Power Supply	
[U.S.A. and Canada models]	AC 120V, 60 Hz
[Australia model]	AC 240V, 50 Hz
[U.K., Europe and Singapore models]	AC 230V, 50 Hz
[General model]	AC 110/120/220/240V, 60/50 Hz
Power consumption	
[U.S.A. and Canada models]	155W
[Australia, U.K., Europe and General models]	150W
Dimensions (W x H x D)	280 x 107.5 x 345 mm
	(11" x 4-1/4" x 13-9/16")
Weight	6.0 kg (13 lbs. 3 oz.)

■ CD player (CDC-S75)

Power Source	AC supplies from receiver unit
Type	3 DISC Carousel Auto-changer
Signal Readout	
	Non-contact, 3-beam semi-conductor laser pick-up
D/A Converter	1-bit DAC
Filter	8-time oversampling 18-bit digital filter
Wow and Flutter	Below measurable limits
Dimensions (W x H x D)	280 x 107.5 x 323 mm
	(11" x 4-1/4" x 12-11/16")
Weight	3.8 kg (8 lbs. 6 oz.)

■ Tape Deck (KXW-S75)

Power Source	AC supplies from receiver unit
Type	Auto Reverse 4-Track 2-Channel playback/recording and playback stereo double Cassette Deck
Heads	PB, REC/PB : Hard Permalloy
	Erase : Double Gap Ferrite
Motors	DC servo motor x 2
Wow and Flutter	±0.19%, W.PEAK
	0.09%, W.RMS
Fast Winding Time (C-60 Tape)	About 120 seconds
Frequency Response (-20 dB)	
	30 – 15,000 Hz ±3 dB (Normal)
	30 – 16,000 Hz ±3 dB (CrO ₂)
	30 – 18,000 Hz ±3 dB (Metal)
Signal-to-Noise Ratio	58 dB (Dolby NR OFF)
	66 dB (Dolby B NR ON)
	74 dB (Dolby C NR ON)
Harmonic Distortion	No more than 1.2%
Channel Separation (Input Shorted 1 kHz)	
	More than 40 dB
Crosstalk (Input Shorted 125 Hz)	More than 55 dB
Dimensions (W x H x D)	280 x 117.5 x 326 mm
	(11" x 4-5/8" x 12-13/16")
Weight	4.2 kg (9 lbs. 4 oz.)
■ Speaker (NX-S75)	
Type	Active Servo Processing type
Speakers	14 cm (5-1/2") woofer
	5 cm (2") tweeter
	1.1 cm super tweeter
Frequency Range	40 – 20,000 Hz
Sound Pressure Level	89 dB
Maximum Power Handling Capacity	75W
Impedance	6 ohms
Dimensions (W x H x D)	200 x 330 x 239 mm
	(7-7/8" x 13 x 9-7/16")
Weight	4.5 kg (9 lbs. 14 oz.) x 2

YAMAHA

YAMAHA ELECTRONICS CORPORATION, USA 6660 ORANGETHORPE AVE., BUENA PARK, CALIF. 90620, U.S.A.
YAMAHA CANADA MUSIC LTD. 135 MILNER AVE., SCARBOROUGH, ONTARIO M1S 3R1, CANADA
YAMAHA ELECTRONIK EUROPA G.m.b.H. SIEMENSSTR. 22-34, 25462 RELLINGEN BEI HAMBURG, F.R. OF GERMANY
YAMAHA ELECTRONIQUE FRANCE S.A. RUE AMBROISE CROIZAT BP70 CROISSY-BEAUBOURG 77312 MARNE-LA-VALLÉE CEDEX02, FRANCE
YAMAHA ELECTRONICS (UK) LTD. YAMAHA HOUSE, 200 RICKMANSWORTH ROAD WATFORD, HERTS WD1 7JS, ENGLAND
YAMAHA SCANDINAVIA A.B. J A WETTERGRENS GATA 1, BOX 30053, 400 43 VÄSTRA FRÖLUNDA, SWEDEN
YAMAHA MUSIC AUSTRALIA PTY, LTD. 17-33 MARKET ST., SOUTH MELBOURNE, 3205 VIC., AUSTRALIA

YAMAHA CORPORATION
VT 51330 Printed in Malaysia

Download from www.Somanuals.com. All Manuals Search And Download.

Free Manuals Download Website

<http://myh66.com>

<http://usermanuals.us>

<http://www.somanuals.com>

<http://www.4manuals.cc>

<http://www.manual-lib.com>

<http://www.404manual.com>

<http://www.luxmanual.com>

<http://aubethermostatmanual.com>

Golf course search by state

<http://golfingnear.com>

Email search by domain

<http://emailbydomain.com>

Auto manuals search

<http://auto.somanuals.com>

TV manuals search

<http://tv.somanuals.com>