

CRX-332

CD RECEIVER
AMPLI-TUNER CD



OWNER'S MANUAL
MODE D'EMPLOI

IMPORTANT SAFETY INSTRUCTIONS

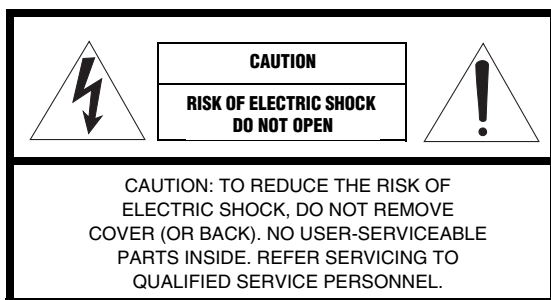

• Explanation of Graphical Symbols



The lightning flash with arrowhead symbol, within an equilateral triangle, is intended to alert you to the presence of uninsulated “dangerous voltage” within the product’s enclosure that may be of sufficient magnitude to constitute a risk of electric shock to persons.



The exclamation point within an equilateral triangle is intended to alert you to the presence of important operating and maintenance (servicing) instructions in the literature accompanying the appliance.

IMPORTANT

Please record the serial number of this unit in the space below.

MODEL:

Serial No.:

The serial number is located on the rear of the unit. Retain this Owner’s Manual in a safe place for future reference.

- 1 Read these instructions.
- 2 Keep these instructions.
- 3 Heed all warnings.
- 4 Follow all instructions.
- 5 Do not use this apparatus near water.
- 6 Clean only with dry cloth.
- 7 Do not block any ventilation openings. Install in accordance with the manufacturer’s instructions.
- 8 Do not install near any heat sources such as radiators, heat registers, stoves, or other apparatus (including amplifiers) that produce heat.
- 9 Do not defeat the safety purpose of the polarized or grounding-type plug. A polarized plug has two blades with one wider than the other. A grounding type plug has two blades and a third grounding prong. The wide blade or the third prong are provided for your safety. If the provided plug does not fit into your outlet, consult an electrician for replacement of the obsolete outlet.
- 10 Protect the power cord from being walked on or pinched particularly at plugs, convenience receptacles, and the point where they exit from the apparatus.
- 11 Only use attachments/accessories specified by the manufacturer.
- 12 Use only with the cart, stand, tripod, bracket, or table specified by the manufacturer, or sold with the apparatus. When a cart is used, use caution when moving the cart/apparatus combination to avoid injury from tip-over.
- 13 Unplug this apparatus during lightning storms or when unused for long periods of time.
- 14 Refer all servicing to qualified service personnel. Servicing is required when the apparatus has been damaged in any way, such as power-supply cord or plug is damaged, liquid has been spilled or objects have fallen into the apparatus, the apparatus has been exposed to rain or moisture, does not operate normally, or has been dropped.



We Want You Listening For A Lifetime

Yamaha and the Electronic Industries Association’s Consumer Electronics Group want you to get the most out of your equipment by playing it at a safe level. One that lets the sound come through loud and clear without annoying blaring or distortion – and, most importantly, without affecting your sensitive hearing. Since hearing damage from loud sounds is often undetectable until it is too late, Yamaha and the Electronic Industries Association’s Consumer Electronics Group recommend you to avoid prolonged exposure from excessive volume levels.



FCC INFORMATION (for US customers)

1 IMPORTANT NOTICE: DO NOT MODIFY THIS UNIT!

This product, when installed as indicated in the instructions contained in this manual, meets FCC requirements. Modifications not expressly approved by Yamaha may void your authority, granted by the FCC, to use the product.

2 IMPORTANT: When connecting this product to accessories and/or another product use only high quality shielded cables. Cable/s supplied with this product **MUST** be used. Follow all installation instructions. Failure to follow instructions could void your FCC authorization to use this product in the USA.

3 NOTE: This product has been tested and found to comply with the requirements listed in FCC Regulations, Part 15 for Class "B" digital devices. Compliance with these requirements provides a reasonable level of assurance that your use of this product in a residential environment will not result in harmful interference with other electronic devices.

This equipment generates/uses radio frequencies and, if not installed and used according to the instructions found in the users manual, may cause interference harmful to the operation of other electronic devices.

Compliance with FCC regulations does not guarantee that interference will not occur in all installations. If this product is found to be the source of interference, which can be determined by turning the unit "OFF" and "ON", please try to eliminate the problem by using one of the following measures:

Relocate either this product or the device that is being affected by the interference.

Utilize power outlets that are on different branch (circuit breaker or fuse) circuits or install AC line filter/s.

In the case of radio or TV interference, relocate/reorient the antenna. If the antenna lead-in is 300 ohm ribbon lead, change the lead-in to coaxial type cable.

If these corrective measures do not produce satisfactory results, please contact the local retailer authorized to distribute this type of product. If you can not locate the appropriate retailer, please contact Yamaha Electronics Corp., U.S.A. 6660 Orangethorpe Ave, Buena Park, CA 90620.

The above statements apply **ONLY** to those products distributed by Yamaha Corporation of America or its subsidiaries.

CAUTION: READ THIS BEFORE OPERATING YOUR UNIT.

- 1 To assure the finest performance, please read this manual carefully. Keep it in a safe place for future reference.
- 2 Install this sound system in a well ventilated, cool, dry, clean place - away from direct sunlight, heat sources, vibration, dust, moisture, and/or cold. For proper ventilation, allow the following minimum clearances around CRX-332.
Top: 20 cm (8 in)
Rear: 10 cm (4 in)
Sides: 10 cm (4 in)
- 3 Locate this unit away from other electrical appliances, motors, or transformers to avoid humming sounds.
- 4 Do not expose this unit to sudden temperature changes from cold to hot, and do not locate this unit in an environment with high humidity (i.e. a room with a humidifier) to prevent condensation inside this unit, which may cause an electrical shock, fire, damage to this unit, and/or personal injury.
- 5 Avoid installing this unit where foreign object may fall onto this unit and/or this unit may be exposed to liquid dripping or splashing. On the top of this unit, do not place:
 - Other components, as they may cause damage and/or discoloration on the surface of this unit.
 - Burning objects (i.e. candles), as they may cause fire, damage to this unit, and/or personal injury.
 - Containers with liquid in them, as they may fall and liquid may cause electrical shock to the user and/or damage to this unit.
- 6 Do not cover this unit with a newspaper, tablecloth, curtain, etc. in order not to obstruct heat radiation. If the temperature inside this unit rises, it may cause fire, damage to this unit, and/or personal injury.
- 7 Do not plug in this unit to a wall outlet until all connections are complete.
- 8 Do not operate this unit upside-down. It may overheat, possibly causing damage.
- 9 Do not use force on switches, knobs and/or cords.
- 10 When disconnecting the power cable from the wall outlet, grasp the plug; do not pull the cable.
- 11 Do not clean this unit with chemical solvents; this might damage the finish. Use a clean, dry cloth.
- 12 Only voltage specified on this unit must be used. Using this unit with a higher voltage than specified is dangerous and may cause fire, damage to this unit, and/or personal injury. Yamaha will not be held responsible for any damage resulting from use of this unit with a voltage other than specified.
- 13 To prevent damage by lightning, keep the power cable and outdoor antennas disconnected from a wall outlet or this unit during a lightning storm.
- 14 Do not attempt to modify or fix this unit. Contact qualified Yamaha service personnel when any service is needed. The cabinet should never be opened for any reasons.
- 15 When not planning to use this unit for long periods of time (i.e. vacation), disconnect the AC power plug from the wall outlet.
- 16 Be sure to read the “TROUBLESHOOTING” section on common operating errors before concluding that this unit is faulty.
- 17 Before moving this unit, press \odot to set this unit to the standby mode, and disconnect the AC power plug from the wall outlet.
- 18 Condensation will form when the surrounding temperature changes suddenly. Disconnect the power cable from the outlet, then leave this unit alone.
- 19 When using this unit for a long time, this unit may become warm. Turn the power off, then leave this unit alone for cooling.
- 20 Install this unit near the AC outlet and where the AC power plug can be reached easily.
- 21 The batteries shall not be exposed to excessive heat such as sunshine, fire or the like.
- 22 Excessive sound pressure from earphones and headphones can cause hearing loss.

This unit is not disconnected from the AC power source as long as it is connected to the wall outlet, even if this unit itself is turned off by \odot . This state is called the standby mode. In this state, this unit is designed to consume a very small quantity of power.

WARNING

TO REDUCE THE RISK OF FIRE OR ELECTRIC SHOCK, DO NOT EXPOSE THIS UNIT TO RAIN OR MOISTURE.

LASER SAFETY

This unit employs a laser. Due to possible eye injury, only a qualified service person should remove the cover or attempt to service this device.

DANGER

This unit emits visible laser radiation when open. Avoid direct eye exposure to beam. When this unit is plugged into the wall outlet, do not place your eyes close to the opening of the disc tray and other openings to look into inside.

LASER

Type	Semiconductor laser GaAs/GaAlAs
Wave length	790 nm
Output Power	7 mW

WARNING

DO NOT TOUCH THIS UNIT WHEN IT IS USED CONTINUOUSLY AT HIGH VOLUME BECAUSE THE BOTTOM OF THIS UNIT MAY BECOME HOT. IT MAY LEAD TO INJURIES SUCH AS BURNS, ETC.

FOR CANADIAN CUSTOMERS

To prevent electric shock, match wide blade of plug to wide slot and fully insert.
This Class B digital apparatus complies with Canadian ICES-003.

CONTENTS

PREPARATION

SUPPLIED ACCESSORIES	2
PLAYABLE DISCS AND FILE FORMAT	3
CONNECTION.....	4
Connecting speakers/antennas/subwoofer	4
Connecting the power cable.....	5
Other connection.....	5
REMOTE CONTROL	6
FRONT PANEL DISPLAY	7



OPERATION

FRONT PANEL AND BASIC OPERATION	8
LISTENING TO MUSIC.....	9
Playback operation.....	9
Other operation	10
LISTENING TO RADIO STATIONS.....	11
Tuning to radio stations	11
Presetting radio stations	11
Selecting preset radio stations (Preset tuning).....	11
USING USEFUL FUNCTIONS	12
Using option menu.....	12
Using sleep timer	12

ADDITIONAL INFORMATION

TROUBLESHOOTING	13
General.....	13
iPod/iPad.....	14
USB/iPad	15
Radio reception	15
Disc playback	16
Remote control	16
HANDLING COMPACT DISCS	17
SPECIFICATIONS.....	17

■ About this manual

- “iPod” described in this manual may also refer to “iPhone”.
- This manual describes how to operate this unit using a remote control except when it is not available. Some of these operations are also available using the front panel buttons.
- The symbol “” with page number(s) indicates the corresponding reference page(s).
- Notes contain important information about safety and operating instructions.  indicates a tip for your operation.
- This manual is printed prior to production. Design and specifications are subject to change in part as a result of improvements, etc. In case of differences between the manual and the product, the product has priority.

SUPPLIED ACCESSORIES

Make sure you have all of the following items.

Remote control



(With CR2032 battery)

FM antenna

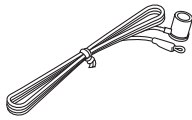

Dock cover



AM antenna



USB cap



CAUTION

Keep the USB cap out of the reach of children, so that it is not mistakenly swallowed.

■ Using the remote control

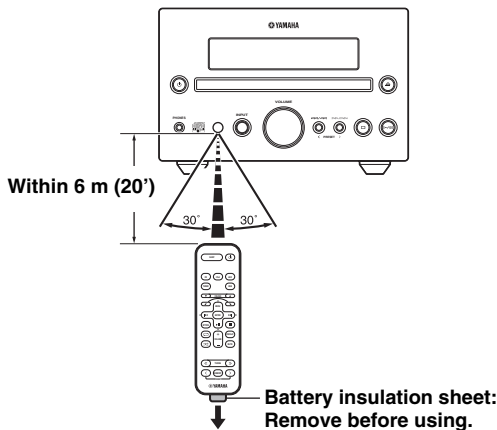

Use the remote control within 6 m (20') of this unit and point it toward the remote control sensor.

Notes

- Do not spill liquid on the remote control.
- Do not drop the remote control.
- Do not leave the remote control in the following places:
 - hot or humid places such as a bathroom or near a heater
 - extremely cold places
 - dusty places

■ Replacing the battery in the remote control

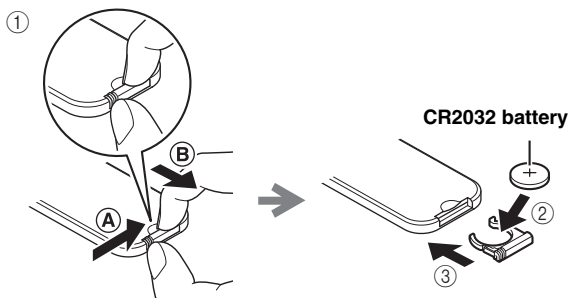

While pushing the release tab in direction (A), slide out the battery holder in direction (B).

Change the battery when the operation range of the remote control decreases.

Notes

- If the battery grows old, the effective operation range of the remote control decreases considerably. If this happens, replace the battery with new one as soon as possible.
- Exhausted battery may leak. If the battery have leaked, dispose of it immediately. Avoid touching the leaked material or letting it come into contact with clothing, etc. Clean the battery compartment thoroughly before installing a new battery.
- Keep the battery away from children. If the battery is accidentally swallowed, contact your doctor immediately.
- When not planning to use the remote control for long periods of time, remove the battery from the remote control.
- Do not charge or disassemble the supplied battery.

PLAYABLE DISCS AND FILE FORMAT

■ Playable discs

Use compact discs bearing the marks below.



.... **Compact discs (digital audio)**



.... **CD-R, CD-RW digital audio discs**

- CD-R or CD-RW discs bearing one of the following phrases.
FOR CONSUMER
FOR CONSUMER USE
FOR MUSIC USE ONLY



- Finalized CD-R or CD-RW discs

Note

This compact disc player may not be able to play some CD-R/CD-RW discs or discs on which recording was not made correctly.



.... **CD-TEXT discs**



To play back an 8-cm (3 in) CD

Place it in the inner recessed area of the disc tray. Do not put a normal (12-cm) CD on top of an 8-cm (3 in) CD.

To prevent a malfunction of this unit:

- Do not use any nonstandard shaped disc (heart, etc.) available on the market because it might damage the unit.
- Do not use a disc with tape, stickers, or paste on it. If you use such a disc, the disc may get stuck in the unit, or damage to the unit may result.



Note: Do not use any lens cleaners as they may be a cause of malfunction.

■ Playable MP3 and WMA files

MP3

Format	Bitrate (kbps)	Sampling frequency (kHz)
MPEG 1 Audio Layer-3	32-320*1	32/44.1/48
MPEG 2 Audio Layer-3, 2	8-160*1	16/22.05/24

*1 Variable bitrate is supported.

WMA

- Version 8
- Version 9 (Standard and variable bitrates are supported. Professional and Lossless are not supported.)

Profile	Bitrate (kbps)	Sampling frequency (kHz)
High Profile	32-320*2	32/44.1/48
Mid Profile	16-32	22.05

*2 Both constant and variable bitrates are supported.

Notes

- Playback for Data Disc starts in alphanumeric order of files.
- Playback for USB starts in order by date and time of creation.
- Copyright-protected WMA (DRM) files cannot be played back by this unit.
- The disc must be ISO 9660 compatible.
- The maximum file and folder numbers are as follows.

	Data Disc	USB
Maximum total number of file and folder*3	512	9,999
Maximum folder number*3	255	999
Maximum file number per folder	511	255

*3 The root is counted as one of the folders.

CONNECTION

Connecting speakers/antennas/subwoofer

Follow the procedure below to connect the speakers and FM/AM antennas to this unit. For information on your speakers, refer to the owner's manual supplied for the speakers.

If a subwoofer is connected, low-frequency audio signals are output through SUBWOOFER OUT.

CAUTION

Do not connect the power cable of this unit until all cable connections are completed.

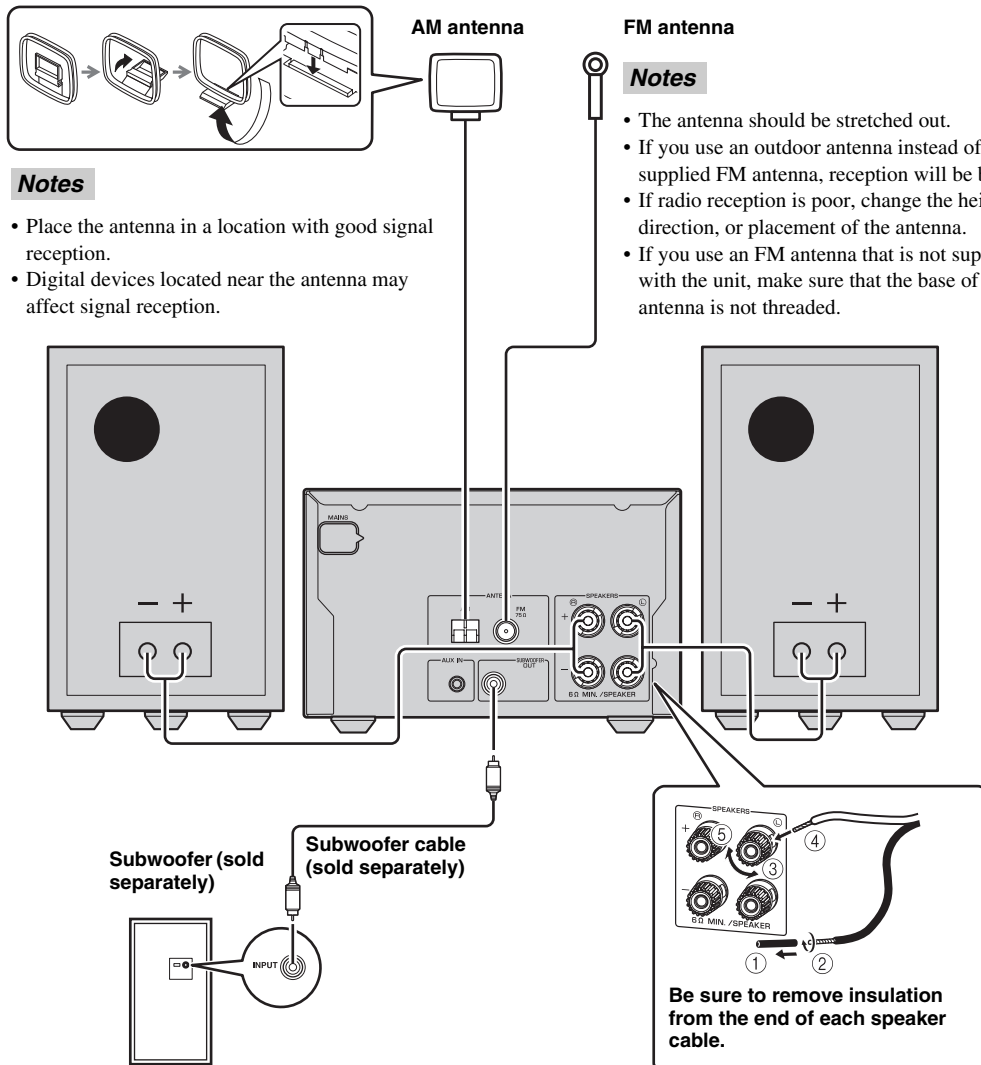

Notes

- If you connect a subwoofer, use a subwoofer that has a built-in amplifier.
- Be sure to connect the left channel (L), right channel (R), “+”(red) “-”(black) properly. If the connections are faulty, no sound will be heard from the speakers, and if the polarity of the speaker connections is incorrect, the sound will be unnatural and lacks bass.
- Do not let the bare speaker wires touch each other or do not let them touch any metal part of this unit. This could damage this unit and/or the speakers.
- Use speakers having more than 6 Ω impedance.
- There is a chance that placing speakers too close to a CRT-based (Braun tube) TV set might impair picture color. Should this happen, move the speakers away from the TV set.

Connecting the power cable

After you made all connections, connect the power cables of this unit

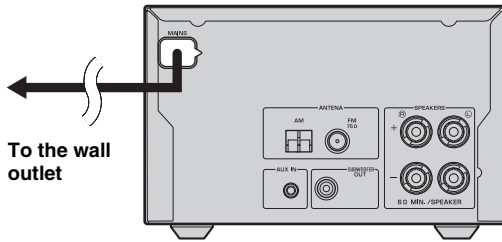

Other connection

Stationing iPod

Station or remove your iPod whenever you want.



An iPod is charged when set in the iPod dock. When the unit is turned on and the input source is set to USB, the iPod is not charged.

Note

This unit is compatible with iPod classic, iPod nano (2nd generation and later), iPod touch and iPhone.

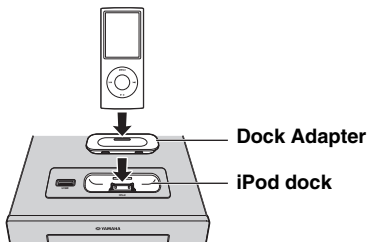

Notes

- To secure the connection, attach a compatible Dock Adapter supplied with the iPod or an iPod Universal Dock Adapter (sold separately), and remove the protective case covering from your iPod.
- If you do not use an adapter or if the adapter is not compatible, the connection could be loose or poor, which could cause damage or malfunctions. For details on dock adaptor information, please visit official Apple's website.
- If an iPod in protective case is connected by force, the connector may be damaged. Remove the protective case before connection.
- Attach the dock cover to the iPod dock whenever you are not using it.

Connecting iPad

Connect or remove your iPad whenever you want.

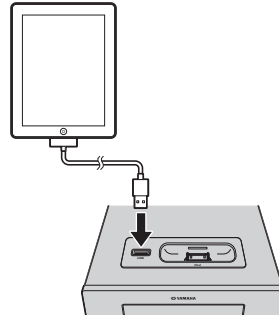

When the unit is turned on and the input source is set to USB, the connected iPad is charged.

Note

- Make sure to use a Dock Connector to USB Cable that is supplied with your iPad.
- When an iPad or USB device is not in use, set the USB cover to protect USB port.

Connecting a USB device

Connect or remove your USB device whenever you want.

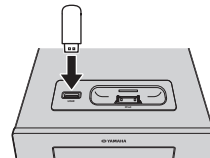

When the unit is turned on and the input source is set to USB, the connected USB device is charged.

Notes

- This unit supports USB mass storage class devices (e.g., flash memories or portable audio players) using FAT16 or FAT32 format.
- Do not connect devices other than USB mass storage class devices (such as USB chargers or USB hubs), PCs, card readers, an external HDD, etc.
- USB devices that use encryption cannot be used.
- When an iPad or USB device is not in use, set the USB cover to protect USB port.

Connecting an external device

Connect your portable audio device using a commercially available 3.5 mm (1/8 in) mini plug cable.

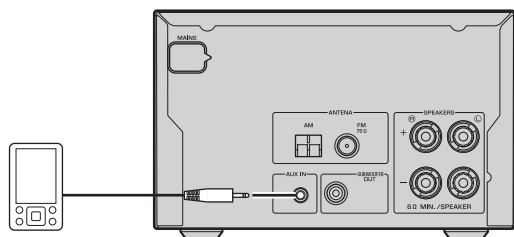

REMOTE CONTROL

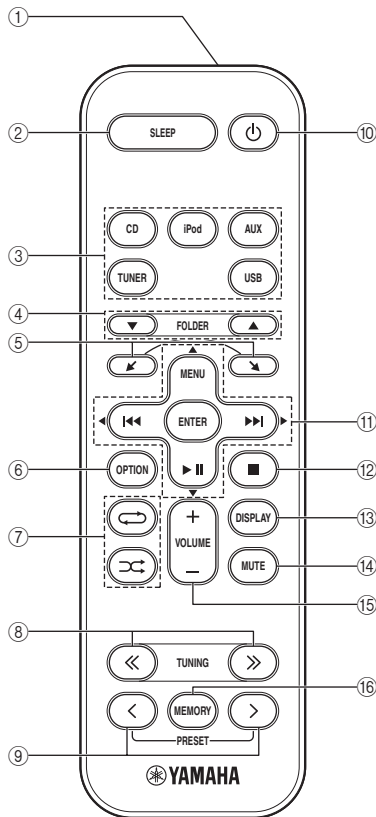

- ① **Infrared signal transmitter**
- ② **SLEEP:** Sleep setting (☞ P. 12)
- ③ **Source buttons:** Change sources. When listening to the radio, press **TUNER** to switch between the FM and AM bands.
- ④ **FOLDER** (during data CD/USB playback): Change folder.
- ⑤ **↶, ↷:** Scrolls through items on the iPod's screen.
- ⑥ **OPTION:** Displays the option menu. (☞ P. 12)
- ⑦ **↻** (Shuffle), **↺** (Repeat) (☞ P. 10)
- ⑧ **TUNING** (during receiving radio): Tuning radio (☞ P. 11)
- ⑨ **PRESET** (during receiving radio): Select the preset radio station (☞ P. 11)
- ⑩ **⏻:** Standby/on
- ⑪ **⏮, ⏭:** (during playback): Skip backward and forward/press and hold to rewind and fast-forward
MENU: Returns to the upper level in the iPod menu.
⏩: Play/pause
▲/▼/◀/▶: (During using the option menu): Changes the setting
ENTER
 (During using the iPod): Select group/start playback
 (During using the option menu): Confirms the setting
- ⑫ **■:** Stop playback.
- ⑬ **DISPLAY:** Switches the information shown on the front panel. (☞ P. 10)
- ⑭ **MUTE:** Mute/resume the sound.
- ⑮ **VOLUME:** Volume control
- ⑯ **MEMORY:** Memories preset radio stations. (☞ P. 11)

FRONT PANEL DISPLAY

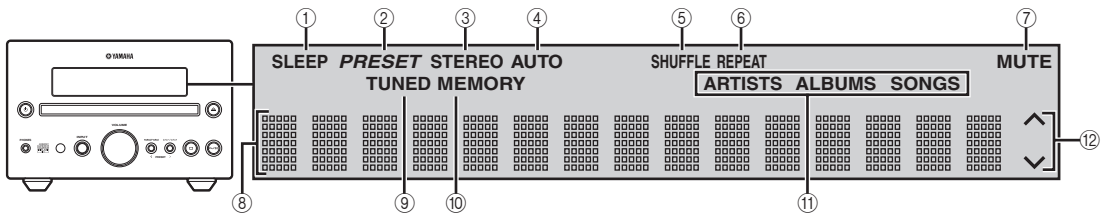

- ① **SLEEP indicator:** Lights up when the sleep timer is on (☞ P. 12).
- ② **PRESET indicator:** Lights up when you preset radio stations (☞ P. 11).
- ③ **STEREO indicator:** Lights up when this unit is receiving a strong signal from an FM stereo broadcast.
- ④ **AUTO indicator:** Lights up when this unit is in the Automatic Tuning mode (☞ P. 11).
- ⑤ **SHUFFLE indicator:** Lights up when you set your iPod/iPad/CD/USB to shuffle play (☞ P. 10).
- ⑥ **REPEAT indicator:** Lights up when you set your iPod/iPad/CD/USB to repeat play (☞ P. 10).
- ⑦ **MUTE indicator:** Lights up when the sound is muted.
- ⑧ **Multi information display:** Shows the various information.
- ⑨ **TUNED indicator:** Lights up when this unit is tuned into a station (☞ P. 11).
- ⑩ **MEMORY indicator:** Flashes when searching for a radio station by automatic preset tuning. Lights up when you preset radio stations automatically or manually (☞ P. 11).
- ⑪ **Multi information indicators:** Indicate the music information currently displayed on Multi information display (☞ P. 10).
- ⑫ **Operation indicators:** Show the available menu buttons for the currently selected OPTION menu item.

FRONT PANEL AND BASIC OPERATION





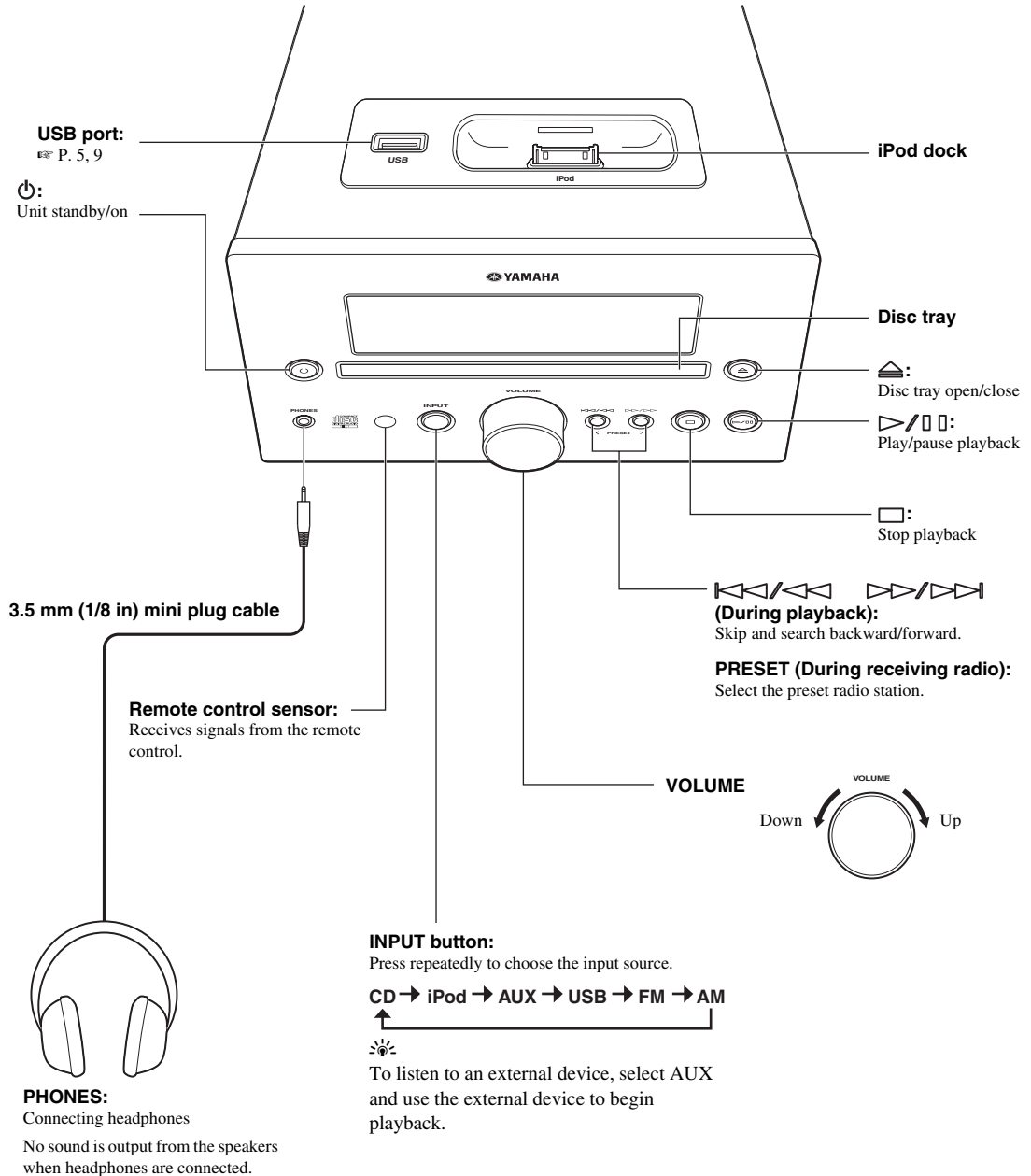



- Press to set the unit to standby mode. All the information on the front panel display is not displayed in standby mode. This can reduce power consumption. To turn on the unit, press , , or on the front panel. If you press , the input source is set to CD, iPod or USB depending on which input source is used last. Playback begins if the input source is set to CD or USB.

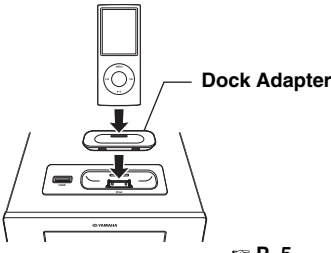

LISTENING TO MUSIC

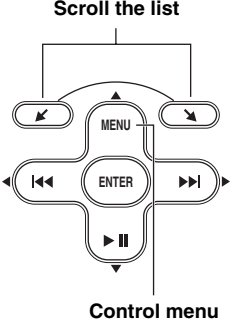
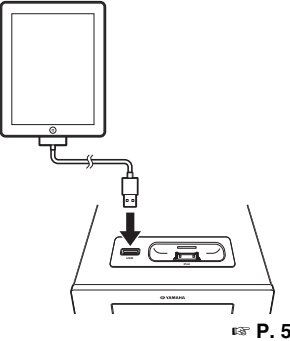
Playback operation

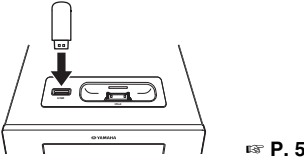
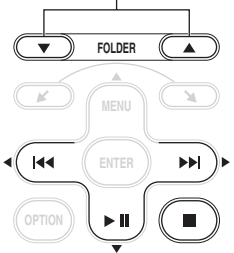
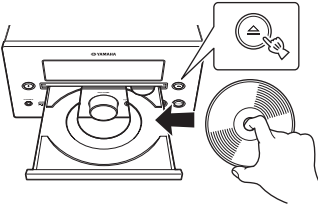
Follow the procedures below to play back music.

	1 Set the source	2 Switch the input	3 Select music and start playback
iPod*1	 <p>Dock Adapter</p> <p>P. 5</p>		<p>Scroll the list</p>  <p>Control menu</p>
iPad*1	 <p>P. 5</p>		
USB*2	 <p>P. 5</p>		<p>Skip to the first file in the previous/next folder for MP3 or WMA*3</p> 
CD			

*1 Some features may not be available depending on the model or the software version of your iPod/iPad.

*2 • Some devices may not work properly even if they meet the requirements.

- Playability of and power supply to all kind of USB devices are not guaranteed.
- The reading time may exceed 30 seconds depending on the number of files/folders.
- Yamaha and suppliers accept no liability for the loss of data saved on the USB devices connected to this unit. As a precaution, it is recommended that the files are made backup copies.

*3 • If you press these buttons, the folder name is displayed on the front panel display for a certain period.

- ROOT is displayed for the root folder when the directory contains playable files.

Other operation

Control playback

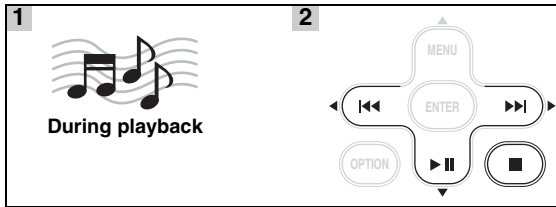

- ▶▶: Skip forward/Press and hold to Fast forward
- ◀◀: Skip backward/Press and hold to Rewind
- ▶||: Play/Pause
- : Stop

Notes

- Playback for Data Disc starts in alphanumeric order of files.
- Playback for USB starts in order by date and time of creation.
- If ■ is pressed during playback, next time playback starts from the beginning of the track you listened to last time. If ■ is pressed again while playback is stopped, next time playback starts from the first track of the CD/USB device.
- This unit automatically switch the unit to standby mode if the unit is left turned on for 1 hour without playback or any other operation being performed (Automatic standby function).

Shuffle play

You can play back in random sequence.



For iPod/iPad

SHUFFLE SONGS → SHUFFLE ALBUMS*1
 ↖ SHUFFLE OFF ↗

*1 You cannot set SHUFFLE ALBUMS when you use an iPod touch, iPhone or iPad.

For CD/USB

SHUFFLE FOLDER*2 → SHUFFLE ALL
 ↖ SHUFFLE OFF ↗

*2 If the audio format of the selected music source is MP3/WMA, you can also select SHUFFLE FOLDER.

Repeat play

You can play back repeatedly.



For iPod/iPad

REPEAT OFF → REPEAT ONE → REPEAT ALL
 ↖ REPEAT OFF ↗

For CD/USB

REPEAT ONE → REPEAT FOLDER*3
 ↖ REPEAT OFF ↗

*3 If the audio format of the selected music source is MP3/WMA, you can also select REPEAT FOLDER.

Switching the display

You can switch the playback information shown on the front panel display. Some special characters may not be shown properly.

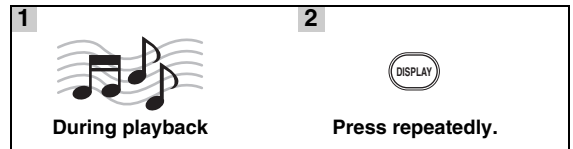

For iPod/iPad

Song number and elapsed time (default setting)

↓

Song number and remaining time

↓

Song name

↓

Artist name

↓

Album name

↓

Back to the default setting

Note

This function is available for iPod classic, iPod nano (2nd generation and later), iPod touch, iPhone and iPad. However, even with these models, this function may not be available depending on the software version of your iPod/iPad.

For CD/USB

Track/file number and elapsed time of the current song (default setting)

↓

Track number and remaining time of the current song*4

↓

Total time of the disc*4

↓

Remaining time of the disc*4

↓

File name*5

↓

Track name*6

↓

Artist name*6

↓

Album name*6

↓

Back to the default setting



*4 Only for Audio CDs

*5 Only for MP3/WMA files

*6 Only when the selected track has information

LISTENING TO RADIO STATIONS

Tuning to radio stations

1  Press repeatedly to select FM/AM mode.	2  Press and hold. Automatic tuning starts.
--	--



If the signal received from the station you want to select is weak, you can also tune into radio stations manually by pressing **TUNING** repeatedly.



Note

If you tune to a station manually, the sound is monaural.

Presetting radio stations

You can store your favorite FM/AM stations with the preset function.

Automatic preset tuning

1  Press and hold MEMORY for more than 2 seconds in FM/AM mode.	2  Start the automatic preset.
--	---







To cancel automatic presetting, press **MEMORY** again without pressing **ENTER** in step 2.

Note

When you perform the automatic preset, all stored stations are cleared and the new stations are stored.

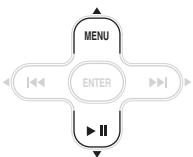
Manual preset tuning

1  Tune into a favorite radio station.	2  Press MEMORY.
3  Select the preset number you want to store to.	4  Complete the manual preset.



- You can preset up to 30 FM and 30 AM stations.
- To cancel the manual preset while choosing a preset number, press **MEMORY** again.
- You can delete a preset station by pressing **OPTION** → Cursor **▲/▼** → **ENTER** to select **PRESET DELETE**.

Selecting preset radio stations (Preset tuning)

	Select the preset radio station in FM/AM mode.
---	---

USING USEFUL FUNCTIONS

Using option menu

The option menu appears on the front panel display by pressing **OPTION**. You can set various useful functions with option menu.

Option menu	Parameter or control range	Reference page
PRESET DELETE	(Displays only when the input source is set to FM/AM.)	11
DIMMER	DIMMER OFF (brightest)/DIMMER 1/DIMMER 2 (darkest)	This page
TREBLE	-10 to +10	This page
BASS	-10 to +10	This page
BALANCE	L+5 - CENTER - R+5	This page
AUTO POWER OFF	TIME OFF/ TIME 8H/ TIME 4H AUTO POWER OFF sets the system to standby mode whenever no operation is performed for a preset amount of time.	This page

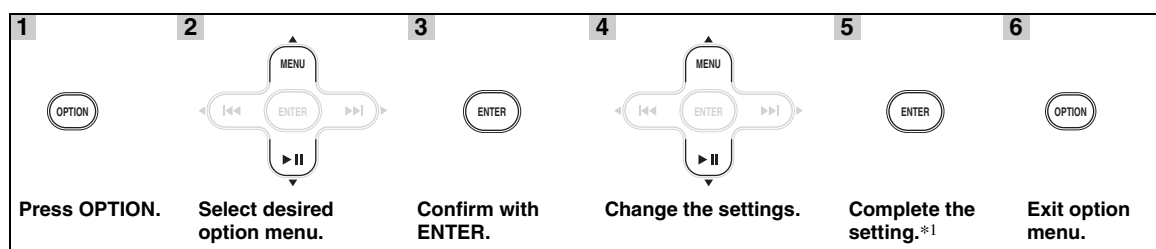

*1 To set additional items, repeat steps 2 to 5.



To cancel the setting during the operation, press **OPTION**.

■ Setting dimmer, tone/balance

DIMMER: Changes the brightness of the front panel display.

TREBLE*2: Adjusts the high frequency response.

BASS*2: Adjusts the low frequency response.

BALANCE: Adjusts the volume level of each left and right speaker channel.

*2 Also effective when you are using headphones.

Using sleep timer

The sleep timer sets the unit to the standby mode after the specified time elapses.



30min → 60min → 90min → 120min → OFF

The SLEEP indicator lights up on the front panel display (P. 7).

TROUBLESHOOTING

Refer to the table below when this unit does not function properly. If the problem you are experiencing is not listed below or if the instruction below does not help, turn off this unit, disconnect the power cable, and contact the nearest authorized Yamaha dealer or service center.

General

Problem	Cause	Remedy	Page
This unit fails to turn on or enters the standby mode soon after the power is turned on.	The power cable is not connected or the plug is not completely inserted.	Connect the power cable firmly.	5
	This unit has been exposed to a strong external electric shock (such as lightning or strong static electricity).	Press and hold  for more than 5 seconds to reset the system. If this does not solve the problem, set this unit to the standby mode, disconnect the power cable, plug it back in after 30 seconds and then use it normally.	—
The unit does not operate properly.			
No sound.	No appropriate input source has been selected.	Select an appropriate input source with INPUT on the front panel (or the source buttons on the remote control).	—
	Speaker connections are not secure.	Secure the connections.	4
	The mute function may be on.	Cancel the mute function.	6
	The volume is turned down.	Turn up the volume.	8
	Signals this unit cannot reproduce are being input from a source component, such as a CD-ROM.	Play a source whose signals can be reproduced by this unit.	3
The power is suddenly turned off.	The sleep timer may be set.	This is not malfunction. Turn on the unit and play the source again.	—
	The unit is left turned on for 1 hour without playback or any other operation being performed.		
	AUTO POWER OFF is triggered.	Setting AUTO POWER OFF to TIME OFF enables to play continuously.	12
Sound is heard from the speaker on one side only.	Incorrect cable connections.	Connect the cables properly. If the problem persists, the cables may be defective.	4
There is noise interference from digital or radio frequency equipment.	This unit is too close to the digital or high-frequency equipment.	Move this unit farther away from such equipment.	—

iPod/iPad

Note

In case of a transmission error without a status message appearing in the front panel of this unit, check the connection to your iPod/iPad (see page 5).

Status message	Cause	Remedy	Page
iPod Connecting iPod Charging	This unit is in the middle of recognizing the connection with your iPod.	If the message continues to appear in the front panel display, disconnect and connect the iPod again.	5
Unknown iPod	There is a problem with the signal path from your iPod to this unit.	Connect the iPod again.	5
	The iPod being used is not supported by this unit.	Only iPod classic, iPod nano (2nd generation and later), iPod touch and iPhone are supported.	—
iPod	This unit has recognized your iPod; however, it cannot obtain information such as elapsed time.		
iPod Unplugged	Your iPod was removed.	Connect the iPod again.	5
Over Current	The iPod being used is not supported by this unit.	Disconnect the iPod and then turn the unit off and on again. Then connect supported iPod again.	5
	The iPod is connected at an angle.		

* Messages shown above appear only when a device is connected to the iPod dock.

Problem	Cause	Remedy	Page
No sound.	The power of the unit is off.	Connect the power cable correctly.	—
	The iPod/iPad software version has not been updated.	Download the latest iTunes software to update the iPod/iPad software version to the latest.	—
	The iPod/iPad is in the process of connecting with the unit.	Please wait for a while.	—
	The iPod/iPad is not connected correctly.	Remove the iPod/iPad from the unit, then connect it again.	5
The iPod/iPad sounds, but you cannot operate it with the unit or the remote control.	The iPod/iPad is not connected correctly.	Remove the iPod/iPad from the unit, then connect it again.	5
You cannot operate from the iPod/iPad.	The iPod/iPad is not connected correctly.	Remove the iPod/iPad from the unit, then connect it again.	5
The playback information is not displayed on the front panel display.	The iPod/iPad you set is not compatible with the playback information display.	Only iPod classic, iPod nano (2nd generation and later), iPod touch, iPhone and iPad are supported.	5
The iPod/iPad does not charge up.	The iPod/iPad is not connected correctly.	Remove the iPod/iPad from the unit, then connect it again.	5
Suddenly the music being played back is canceled and another track starts playing without performing any operation.	The iPod's Shake to Shuffle function is turned on.	Turn off the Shake to Shuffle function in the iPod's settings.	—

USB/iPad

Note

In case of a transmission error without a status message appearing in the front panel of this unit, check the connection to the USB device (see page 5).



Status message	Cause	Remedy	Page
USB Unplugged	The USB device is not connected firmly.	Connect the USB device again.	5
Unknown USB	The connected USB device is not playable on this unit.	Connect playable USB device.	5
	The file name is too long.	The file name should be no more than 250 characters.	—
Over Current	The USB device is connected at an angle.	Disconnect the USB device and then turn the unit off and on again. Then connect playable USB device again.	5
No Files	The USB device does not contain playable files.	Use a USB device contains playable files.	3
	An incompatible USB device is connected to the unit.	Turn off the system and reconnect the USB device to the unit. If it does not resolve the problem, the USB device is not playable on the unit.	—
USB Time Out	The number of files/folders exceeds the limit.	Reduce the number of files/folders; refer to the limitations noted in this manual.	3

Problem	Cause	Remedy	Page
MP3/WMA file in the USB device does not play.	The USB device is not recognized.	Connect the USB device again.	5
		Connect an AC adapter if supplied with the device.	—
		Format the USB device and copy the files again.	—
	Improper USB device connections.	Connect the USB device again.	5
	The MP3 or WMA formats are not compatible with this unit.	Replace the file with a correctly recorded file playable with this unit.	3
	If the solutions above do not resolve the problem, the USB device is not playable on the unit.	Try another USB device.	—

Radio reception

Problem	Cause	Remedy	Page
FM stereo reception is noisy.	The antenna is connected improperly.	Check the antenna connections.	4
	The characteristics of FM stereo broadcasts may cause this problem when the transmitter is too far away or the antenna input is poor.	Try using a high-quality antenna.	—
		Use the manual tuning method.	11
The desired station cannot be tuned into with the automatic tuning method.	The signal is too weak.	Use a high-quality antenna.	—
		Use the manual tuning method.	11
The preset selecting function does not work.	The preset (memory) may have been erased.	Preset radio stations again.	11
There is distortion, and clear reception cannot be obtained even with a good antenna or an outdoor antenna.	Multipath reflection or other radio interference may have occurred.	Change the height, direction, or placement of the antenna.	—

Disc playback

Problem	Cause	Remedy	Page
No sound or distorted sound	The sampling rate of an MP3 or WMA file may not be compatible with this unit.	Check the sampling rate and bit rate of an MP3 or WMA file are compatible with this unit.	3
Disc playback does not start.	You may be using a CD-R/RW that is not finalized.	Finalize the CD-R/RW.	—
	The disc label may be upside down.	Check that the disc label is facing up.	—
	The disc may be defective.	Try playing back another disc. If this cures the problem, the disc you want to play back is defective.	—
	MP3/WMA disc may not contain sufficient music files to be played back.	Check that your MP3/WMA disc contains at least 5 MP3/WMA music files. If the number of files is small, the disc may not be recognized.	—
	The sampling rate of an MP3 or WMA file may not be compatible with this unit.	Check the sampling rate and bit rate of an MP3 or WMA file are compatible with this unit.	3
Some button operations do not work.	The disc loaded into the unit may not be compatible.	Remove the disc and then check whether the unit supports the disc or not.	3
Playback does not start immediately after pressing  on the unit or  on the remote control.	The disc may be dirty.	Wipe the disc clean.	—
	The disc loaded into the unit may not be compatible.	Use a disc supported by the unit.	3
	If the unit was moved from a cold to warm place, condensation may have formed on the disc reading lens.	Wait for an hour or two until the unit adjusts to the room temperature, and try again.	—
“No Disc” appears in the display even though a disc is in the disc tray.	The disc loaded into the unit may not be compatible.	Use a disc supported by the unit.	3
	The disc may be dirty.	Remove the disc and then wipe the disc clean.	—
	Disc is loaded upside-down.	Remove the disc and then load the disc with the labeled side facing up.	—

Remote control

Problem	Cause	Remedy	Page
The remote control does not work nor function properly.	The remote control may be operated outside its operation range.	For information on the remote control operation range, refer to “Using the remote control”.	2
	The remote control sensor on this unit may be exposed to direct sunlight or lighting.	Change the lighting or orientation of this unit.	—
	The battery may be worn out.	Replace the battery with new one.	2
	There are obstacles between the sensor of this unit and the remote control.	Remove the obstacles.	—

HANDLING COMPACT DISCS

- Always handle with care so that the playing surface is not scratched. Do not bend discs.

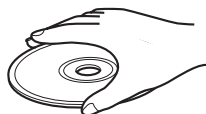

- To keep the playing surface clean, wipe with a clean, dry cloth. Do not use any type of disc cleaner, spray, or any other chemical-based liquid.
- Do not expose discs to direct sunlight, high temperature or high humidity for a long time.

- Do not wipe with a circular motion; wipe straight outward from the center.

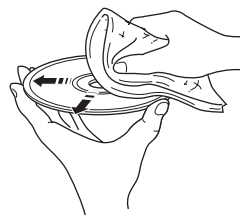

- Use a soft-tipped pen when writing on the label side of a disc.

SPECIFICATIONS

PLAYER SECTION

iPod

- Supported iPod.....iPod classic, iPod nano (2nd generation and later), iPod touch, iPhone, iPad

CD

- Media.....CD, CD-R/RW
- Audio format.....Audio CD, MP3, WMA

LASER

- Type.....Semiconductor laser GaAs/GaAlAs
- Wave length.....780 nm
- Output Power.....10 mW

USB

- Audio format.....MP3, WMA

AUX

- Input connector.....STEREO L/R: 3.5 mm STEREO mini Jack

AMPLIFIER SECTION

- Maximum output power20 W + 20 W
(6 Ω 1 kHz, 10% THD)
- Input impedance (AUX)73 kΩ
- Maximum input signal (AUX).....2.2 V
- Total harmonic distortion
CD etc. 1 kHz/8 W.....0.04 %

TUNER SECTION

- Tuning range
FM
[U.S.A. and Canada models] 87.5 to 107.9 MHz
[Other models]..... 87.50 to 108.00 MHz
AM.....530 to 1710 KHz

GENERAL

- Power Supply
[Europe model]AC 230 V, 50 Hz
[U.S.A. and Canada models]AC 120 V, 60 Hz
[Asia model] AC 220-240 V, 50/60 Hz
[Taiwan model]..... AC 110-120 V, 60 Hz
[Australia model]AC 240 V, 50 Hz
[U.K. model].....AC 230 V, 50 Hz
[China model]AC 220 V, 50 Hz
[Korea model]AC 220 V, 60 Hz
- Power consumption32 W

- Standby Power consumption.....0.3 W or less
- Dimensions (W × H × D)..... 180 × 118 × 318.2 mm
(7 1/8 × 4 5/8 × 12 1/2 in)
- Weight.....2.95 kg (6.5 lbs.)

Specifications are subject to change without notice.

iPod, iPhone, iPad

“Made for iPod,” “Made for iPhone,” and “Made for iPad” mean that an electronic accessory has been designed to connect specifically to iPod, iPhone, or iPad, respectively, and has been certified by the developer to meet Apple performance standards. Apple is not responsible for the operation of this device or its compliance with safety and regulatory standards. Please note that the use of this accessory with iPod, iPhone, or iPad may affect wireless performance.

iPad, iPhone, iPod, iPod classic, iPod nano, iPod shuffle, and iPod touch are trademarks of Apple Inc., registered in the U.S. and other countries.

CAUTION

Use of controls or adjustments or performance of procedures other than those specified herein may result in hazardous radiation exposure.

AVERTISSEMENT

L'utilisation de commandes et l'emploi de réglages ou de méthodes autres que ceux décrits ci-dessous, peuvent entraîner une exposition à un rayonnement dangereux.

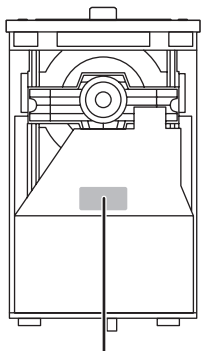

DANGER: AVOID DIRECT EXPOSURE TO THE BEAM
INVISIBLE LASER RADIATION WHEN OPEN

CAUTION: DO NOT STARE INTO BEAM
INVISIBLE LASER RADIATION WHEN OPEN

(Traduction française)

DANGER : ÉVITER UNE EXPOSITION DIRECTE AU RAYON RADIATION LASER INVISIBLE QUAND L'APPAREIL EST OUVERT

ATTENTION : NE PAS REGARDER FIXEMENT LE FAISCEAU RADIATION LASER INVISIBLE QUAND L'APPAREIL EST OUVERT

The laser component in this product is capable of emitting radiation exceeding the limit for Class 1.

Le laser de cet appareil peut émettre un rayonnement dépassant les limites de la classe 1.

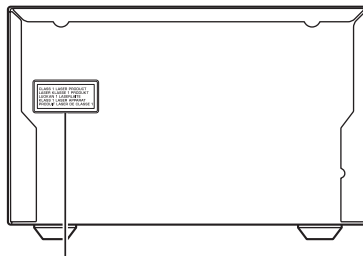

- The label is located on the bottom of the unit. (U.S.A and Canada models only)
- L'étiquette est située sur la base de l'unité (États-Unis et le Canada modèles seulement).

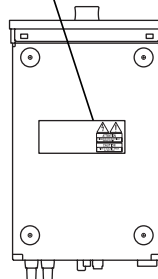



Free Manuals Download Website

<http://myh66.com>

<http://usermanuals.us>

<http://www.somanuals.com>

<http://www.4manuals.cc>

<http://www.manual-lib.com>

<http://www.404manual.com>

<http://www.luxmanual.com>

<http://aubethermostatmanual.com>

Golf course search by state

<http://golfingnear.com>

Email search by domain

<http://emailbydomain.com>

Auto manuals search

<http://auto.somanuals.com>

TV manuals search

<http://tv.somanuals.com>